



Simply Better Connections

ATEN VanCryst™

**VM3404H / VM3909H**

4 x 4 / 9 x 9 HDMI HDBaseT-Lite  
Matrix Switch  
User Manual

## Compliance Statements

---

### FEDERAL COMMUNICATIONS COMMISSION INTERFERENCE STATEMENT

This equipment has been tested and found to comply with the limits for a Class A digital device, pursuant to Part 15 of the FCC Rules. These limits are designed to provide reasonable protection against harmful interference when the equipment is operated in a commercial environment. This equipment generates, uses, and can radiate radio frequency energy and, if not installed and used in accordance with the instruction manual, may cause harmful interference to radio communications. Operation of this equipment in a residential area is likely to cause harmful interference in which case the user will be required to correct the interference at his own expense.

The device complies with Part 15 of the FCC Rules. Operation is subject to the following two conditions: (1) this device may not cause harmful interference, and (2) this device must accept any interference received, including interference that may cause undesired operation.

### FCC Caution

Any changes or modifications not expressly approved by the party responsible for compliance could void the user's authority to operate this equipment.

### Warning

Operation of this equipment in a residential environment could cause radio interference.

### Achtung

Der Gebrauch dieses Geräts in Wohnumgebung kann Funkstörungen verursachen.



### KCC Statement

유선 제품용 / A 급 기기 (업무용 방송 통신 기기)  
이 기기는 업무용 (A 급) 전자파적합기기로서 판매자 또는 사용자는 이  
점을 주의하시기 바라며, 가정 외의 지역에서 사용하는 것을 목적으로  
합니다.

### **HDMI Trademark Statement**

The terms HDMI, HDMI High-Definition Multimedia Interface, and the HDMI Logo are trademarks or registered trademarks of HDMI Licensing Administrator, Inc.



### **RoHS**

This product is RoHS compliant.

## About this Manual

---

This User Manual is provided to help you get the most from your VM3404H / VM3909H system. It covers all aspects of installation, configuration and operation. An overview of the information found in the manual is provided below.

**Chapter 1 Introduction**, introduces you to the VM3404H / VM3909H system. Its purpose, features and benefits are presented, and its front and back panel components are described.

**Chapter 2 Hardware Setup**, describes how to set up your VM3404H / VM3909H installation.

**Chapter 3 Front Panel Configuration**, explains the fundamental concepts involved in operating the VM3404H / VM3909H at the local site via the front panel LCD display using pushbuttons.

**Chapter 4 Browser Operation**, provides a complete description of the VM3404H / VM3909H's Browser Graphical User Interface (GUI), and how to use it to remotely configure and operate the VM3404H / VM3909H.

**Chapter 5 Mobile Control**, introduces you to the Video Matrix Control app and provides details on its installation requirements.

**Chapter 6 CLI Commands**, provides a complete list of the serial control protocol commands used when utilizing the RS-232 Serial Port so that an extra source device can be utilized in the installation.

**Appendix**, provides specifications and other technical information regarding the VM3404H / VM3909H.

## **Conventions**

This manual uses the following conventions:

- |   |  |
|---|--|
| Monospaced  | Indicates text that you should key in.   |
| [ ]   | Indicates keys you should press. For example, [Enter] means to press the <b>Enter</b> key. If keys need to be chorded, they appear together in the same bracket with a plus sign between them: [Ctrl+Alt]. |
| 1.  | Numbered lists represent procedures with sequential steps.   |
| ◆   | Bullet lists provide information, but do not involve sequential steps.   |
| >   | Indicates selecting the option (on a menu or dialog box, for example), that comes next. For example, Start > Run means to open the <i>Start</i> menu, and then select <i>Run</i> .                         |
|  | Indicates critical information.  |

## Package Contents

---

The VM3404H / VM3909H package consists of:

- ◆ 1 VM3404H / VM3909H 4 x 4 / 9 x 9 HDMI HDBaseT-Lite Matrix Switch
- ◆ 1 power cord
- ◆ 1 mounting kit
- ◆ 1 user instructions\*

Check to make sure that all the components are present and that nothing got damaged in shipping. If you encounter a problem, contact your dealer.

Read this manual thoroughly and follow the installation and operation procedures carefully to prevent any damage to the unit, and/or any of the devices connected to it.

---

\* Features may have been added to the VM3404H / VM3909H since this manual was published. Please visit our website to download the most up-to-date version.

---

---

## Product Information

---

For information about all ATEN products and how they can help you connect without limits, visit ATEN on the Web or contact an ATEN Authorized Reseller. Visit ATEN on the Web for a list of locations and telephone numbers:

---

International	<a href="http://www.aten.com">http://www.aten.com</a>
North America	<a href="http://www.aten-usa.com">http://www.aten-usa.com</a>

---

---

## User Information

---

### Online Registration

Be sure to register your product at our online support center:

---

International	<a href="http://eservice.aten.com">http://eservice.aten.com</a>
---------------	---

---

### Telephone Support

For telephone support, call this number:

---

International	886-2-8692-6959
China	86-400-810-0-810
Japan	81-3-5615-5811
Korea	82-2-467-6789
North America	1-888-999-ATEN ext 4988 1-949-428-1111

---

## **User Notice**

All information, documentation, and specifications contained in this manual are subject to change without prior notification by the manufacturer. The manufacturer makes no representations or warranties, either expressed or implied, with respect to the contents hereof and specifically disclaims any warranties as to merchantability or fitness for any particular purpose. Any of the manufacturer's software described in this manual is sold or licensed *as is*. Should the programs prove defective following their purchase, the buyer (and not the manufacturer, its distributor, or its dealer), assumes the entire cost of all necessary servicing, repair and any incidental or consequential damages resulting from any defect in the software.

The manufacturer of this system is not responsible for any radio and/or TV interference caused by unauthorized modifications to this device. It is the responsibility of the user to correct such interference.

The manufacturer is not responsible for any damage incurred in the operation of this system if the correct operational voltage setting was not selected prior to operation. **PLEASE VERIFY THAT THE VOLTAGE SETTING IS CORRECT BEFORE USE.**

# Table of Contents

---

Compliance Statements . . . . .	ii
About this Manual . . . . .	iv
Conventions . . . . .	v
Package Contents . . . . .	vi
Product Information . . . . .	vii
User Information . . . . .	vii
Online Registration . . . . .	vii
Telephone Support . . . . .	vii
User Notice . . . . .	viii
Table of Contents . . . . .	ix
<b>1. Introduction</b>	
Overview . . . . .	1
Features . . . . .	3
Requirements . . . . .	5
Source Devices . . . . .	5
Display Devices . . . . .	5
Cables . . . . .	5
Source Device Operating Systems . . . . .	6
Browsers . . . . .	6
Components . . . . .	7
VM3404H Front View . . . . .	7
VM3404H Rear View . . . . .	8
VM3909H Front View . . . . .	9
VM3909H Rear View . . . . .	10
<b>2. Hardware Setup</b>	
Rack Mounting . . . . .	11
Grounding . . . . .	13
Cable Connection . . . . .	14
Installation Diagram . . . . .	15
<b>3. Front Panel Configuration</b>	
Overview . . . . .	17
Front Panel Pushbuttons . . . . .	17
Enter Password . . . . .	18
Main Screen . . . . .	19
Port Switching . . . . .	19
Input Port Selection . . . . .	19
Output Port Selection . . . . .	21
LCD Menu Organization . . . . .	23
Menu Pushbutton . . . . .	23
IP Setting . . . . .	24

IP Address / Subnet Mask . . . . .	24
Gateway . . . . .	24
Serial Port Setting . . . . .	26
Baud Rate . . . . .	26
Operation Mode . . . . .	27
EDID Mode . . . . .	27
CEC . . . . .	28
OSD . . . . .	29
Output Status . . . . .	30
Security Mode . . . . .	32
Mode . . . . .	32
Change Password . . . . .	33
Save to a Profile . . . . .	35
Play/Stop the Profile Schedule . . . . .	36
Turn Video Wall Off . . . . .	36
Profile Pushbutton . . . . .	37

## 4. Browser Operation

Overview . . . . .	39
Logging In . . . . .	39
Main Page . . . . .	40
Menu Bar . . . . .	40
Profile List . . . . .	41
Adding/Playing a Profile . . . . .	41
Importing / Exporting a Profile . . . . .	43
Profile List Options . . . . .	43
Profile . . . . .	44
Play Window . . . . .	44
Profile Scheduling . . . . .	46
Connection Profiles . . . . .	48
Digital Signage Profile . . . . .	48
Output Icon . . . . .	49
Grid View . . . . .	50
Output Options . . . . .	50
Video Wall Profile . . . . .	51
Video Wall Options . . . . .	51
Number of Displays / Output Order / Bezel Dimensions . . . . .	52
Null Input . . . . .	53
Independent Output . . . . .	53
Grouping . . . . .	54
Group . . . . .	54
Display Preferences . . . . .	55
Video Wall Example 1 . . . . .	56
Video Wall Example 2 . . . . .	56
Output Option . . . . .	58
Video Control's . . . . .	58

---

System Settings	59
General	60
Fan Status	60
Device Info	60
Other	60
User Account	62
Add Account	63
Permission Level	64
Port Name	65
Network	66
EDID Settings	67
EDID Mode	68
EDID & CEA Description	69
Customized Mode	70
Customized EDID Parameters	71
CEA Settings	74
Video Data	75
Detail Timing / Display Description	76
Maintenance	77
IR Channel	78
HDCP	79
OSD/CEC	80
<b>5. Mobile Control</b>	
Overview	81
The Video Matrix Control App	82
Requirements	82
Installation and Connections	82
The Control Interface	83
<b>6. CLI Commands</b>	
Overview	85
Connecting to the Matrix Switch via Telnet	85
Connecting to the Matrix Switch via RS-232	86
Verification	87
Commands	87
Switch Port Command	87
EDID Mode Command	89
CEC Command	90
Scaling Command	91
Echo Command	94
Read Command	95
Reset Command	96
Baud Rate Command	97
Save/Load Profile Command	98
OSD Command	99

---

## Appendix

Safety Instructions	101
General	101
Rack Mounting	103
Technical Support	104
International	104
North America	104
Specifications	105
Compatible Receivers	107
Telnet Operation	108
Configuration Menu	108
1. H – Call up the command list for help	108
2. IP – Set IP address	108
3. LO – Load connections from profile	108
4. PW – Change password	109
5. RI – Read what input is connected to nn output	109
6. RO – Read what output is connected to nn input	109
7. SB – Set serial port baud rate	109
8. SS – Switch input to specified output	109
9. SV – Save the current connections into a profile	109
10. TI – Set timeout	109
11. VR – Software version information	109
Limited Warranty	110

# Chapter 1

## Introduction

### Overview

---

The ATEN VanCryst VM3404H / VM3909H 4 x 4 / 9 x 9 HDMI HDBaseT-Lite Matrix Switch is a versatile solution that provides an easy way to route high definition video and audio from any of 4/9 HDMI sources to any of 4/9 HDMI/HDBaseT displays at the same time. As a Matrix Switch, each input can be independently connected to any or all outputs, giving you the ultimate in flexibility and control in any multi-display audio/video installation.

Furthermore, with the latest HDBaseT technology, the VM3404H / VM3909H is able to extend HDMI sources up to 4K2K high-resolution video (with audio signals) over single Cat5 cable to receivers up to 60m away. The VM3404H / VM3909H also features Power over HDBaseT (POH), which can send power over Cat 5e/6 cable without an additional power supply.

When the VM3404H / VM3909H is combined with VE805R/VE816R receivers, it supports both ATEN Seamless Switch™ technology and Video Wall functionality, employing FPGA matrix system architecture to seamlessly switch between multiple sources and multiple displays. With EDID Expert technology, the VM3404H / VM3909H selects the optimum EDID settings for smooth power-up and the highest quality display. It also features a high-performing scaling engine that converts the video resolution into the display's native resolution to give you the best image quality.

You can easily configure the VM3404H / VM3909H via the front panel LCD display and pushbuttons, and through the use of an IR Remote Control. The LCD provides a quick view of all port connections, and lets operators access the unit's built-in configuration utility.

Furthermore, the VM3404H / VM3909H allows convenient configuration and operation via an intuitive Graphical User Interface (GUI) using any web browser. The web GUI provides you with advanced features which include easy setup of custom Video Wall (when used in conjunction with VE805R/VE816R receivers) and Digital Signage configurations that can be saved and recalled. Because your VM3404H / VM3909H can be controlled over a standard TCP/IP connection, it conveniently integrates into any existing network for easy remote access. For complete system and install integration, serial control is standard through the VM3404H / VM3909H's built-in RS-232 port that allows the switch to be controlled through a high-end controller or PC.

The VM3404H / VM3909H also supports mobile control of frequently used features such as switching of profile and AV inputs using ATEN Video Matrix Control app.

The VM3404H / VM3909H is an ideal solution for applications that require HDMI outputs from multiple sources to be conveniently delivered to multiple destinations, such as for stage presentations, competitions, control centers, and system installations that require real-time reports.

---

## Features

---

- ◆ Supports 4 (VM3404H) or 9 (VM3909H) HDMI inputs and mirrored 4 / 9 HDMI and HDBaseT outputs
- ◆ Long Distance Transmission – supports up to 60 m (using Cat 5e/6 cables) or 70m (Cat 6a)
- ◆ HDMI (4K, 3D, Deep Color); HDCP 1.4 compatible
- ◆ Video Wall - allows you to create custom video wall layouts via intuitive web GUI

---

**Note:** 1. The video wall feature is only available when the VM3404H / VM3909H is used in conjunction with the VE805R/VE816R.

2. The VE816R is only supported on VM3404H / VM3909H using firmware version 2.2.213 or later.

---

- ◆ Features a built in high-performance scaler function for best image quality (Only available when the VM3404H / VM3909H is used in conjunction with the VE805R/VE816R.)
- ◆ Easily switch between multiple sources and multiple displays
- ◆ Seamless Switch™ – provides continuous video streams, real-time switching and stable signal transmission

---

**Note:** 1. If Seamless Switch™ is enabled, the video output will not display 4K, 3D, Deep Color or interlaced resolutions (i.e., 1080i). For these features, you must disable Seamless Switch™.

2. Seamless Switch™ is only available when the VM3404H / VM3909H is used in conjunction with the VE805R/VE816R.

3. The VE816R is only supported on VM3404H / VM3909H using firmware version 2.2.213 or later.

---

- ◆ EDID Expert™ – selects optimum EDID settings for smooth power-up and highest quality display
  - ◆ Configuration and control via the front-panel LCD display and the pushbuttons, and web GUI
  - ◆ Supports free mobile control using the Video Matrix Control App
  - ◆ System Operation:
    - ◆ Serial controller
-

- ◆ Browser Graphical User Interface (GUI)
- ◆ Telnet
- ◆ Built-in bi-directional RS-232 serial port for high-end system control
- ◆ Superior video quality – HDTV resolution of 480p, 720p, 1080i, 1080p (1920 x 1080) and 4K
- ◆ Supports Dolby True HD and DTS HD Master audio
- ◆ Consumer Electronics Control (CEC) support
- ◆ ESD protection for HDMI connections
- ◆ Firmware upgradeable
- ◆ Rack mountable all metal casing

## **Requirements**

---

The following devices are required for a complete VM3404H / VM3909H installation:

### **Source Devices**

- ◆ Computer or A/V source device with HDMI Type-A output connector(s)

---

**Note:** A DVI/HDMI adapter is required when connecting a DVI source device.

---

### **Display Devices**

- ◆ Display devices or receivers with an HDMI Type-A input connector

### **Cables**

- ◆ 1 HDMI cable for each source device you will be connecting
- ◆ 1 HDMI cable for each display device you will be connecting
- ◆ 1 Cat 5e cable
- ◆ 1 RS-232 serial cable

---

**Note:** No cables are included in this package. We strongly recommend that you purchase high-quality cables of appropriate length since this will affect the quality of the audio and video display. Contact your dealer to purchase the correct cable sets.

---

## **Source Device Operating Systems**

Supported operating systems are shown in the table below:

<b>OS</b>		<b>Version</b>
Windows		2000 and higher
Linux	RedHat	6.0 and higher
	SuSE	8.2 and higher
	Mandriva (Mandrake)	9.0 and higher
UNIX	AIX	4.3 and higher
	FreeBSD	3.51 and higher
	Sun	Solaris 8 and higher
Novell	Netware	5.0 and higher
Mac		OS 9 and higher
DOS		6.2 and higher

## **Browsers**

Supported web browsers are shown in the table below:

<b>OS</b>	<b>Java Version</b>	<b>Browser</b>	<b>Version</b>
Windows 8.1	V1.8.0_60	Chrome	45.0.2454.85 m
		Firefox	40.0.3
		Safari	5.1.7
		Opera	31.0.1889.174
		IE11	11
Windows 2012 R2 (64bit)	V1.8.0_60 (64bit)	IE11	11 (64bit)
Windows 2008 R2 (64bit)	V1.8.0_60 (64bit)	IE8	8
Windows 7 SP1(64bit)	V1.8.0_60 (64bit)	IE10	10 (64bit)
Windows XP	V1.8.0_60	IE8	8
CentOS 7.0 (64Bit)	V1.8.0_60 (64bit)	Firefox	40.0.3
Ubuntu 12.04	V1.8.0_60	Chrome	45.0.2454.85
Solaris 11(64bit)	V1.8.0_25	Firefox	33
Mac 10.10	V1.8.0_25	Safari	8

## Components

### VM3404H Front View

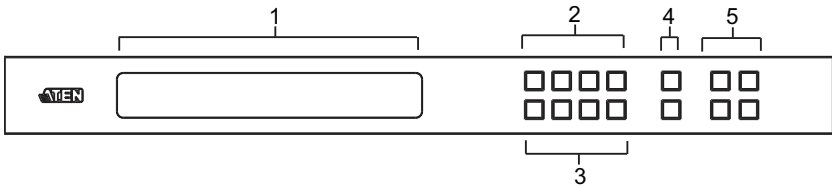

No.	Component	Description
1	LCD display	The LCD display gives a quick view of all port connections, and shows the various options for configuring and operating the VM3404H. For full details, see <i>Main Screen</i> , page 19.
2	input pushbuttons	These pushbuttons refer to the HDMI input ports found on the VM3404H rear panel. Press to select the input port. These pushbuttons may also correspond to menu options, connection profiles (P1–P4) and so on. <b>Note:</b> The <b>INPUT</b> (1–4) front panel pushbuttons have built-in LEDs that light to indicate they have been selected.
3	output pushbuttons	These pushbuttons refer to the HDMI / HDBaseT output ports found on the VM3404H rear panel. Press to select the output port. These pushbuttons may also correspond to connection profiles (P5–P8). <b>Note:</b> The <b>OUTPUT</b> (1–4) front panel pushbuttons have built-in LEDs that light to indicate they have been selected.
4	Prev / Next pushbuttons	These pushbuttons allow you to cycle through the menu options on the LCD display.
5	function pushbuttons	The function pushbuttons ( <b>MENU</b> , <b>PROFILE</b> , <b>ENTER</b> and <b>CANCEL</b> ) are for navigating the LCD built-in configuration utility. For full details, see <i>Front Panel Pushbuttons</i> , page 17. <b>Note:</b> The <b>MENU</b> and <b>PROFILE</b> front panel pushbuttons have built-in LEDs that light to indicate they have been selected.

## VM3404H Rear View

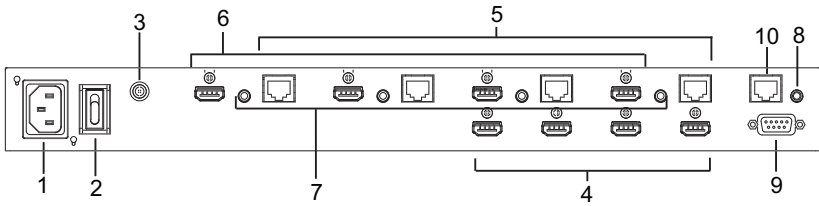

No.	Component	Description
1	power socket	This is a standard 3-pin AC power socket. The power cord from an AC source plugs in here.
2	power switch	This is a standard rocker switch that powers the unit on and off.
3	grounding terminal	The grounding wire attaches here. See <i>Grounding</i> , page 13, for further details.
4	HDMI input ports	The cables from your HDMI source devices plug into these ports.
5	HDBaseT output ports	The cables from your remote HDBaseT display devices or HDBaseT receivers plug into these ports.
6	HDMI output ports	The cables from your local HDMI display devices plug into these ports.
7	IR channel ports	Connect IR receivers / transmitters into the IR channel ports for controlling the source and the display from local or remote locations.
8	IR port	Connect an IR unit via the 3.5 mm mini stereo jacks. IR signals are used to control the VM3404H.
9	RS-232 serial port	Connect a computer or high-end system controller via this serial port.
10	Ethernet port	In order to access the VM3404H's Browser Graphical User Interface (GUI), the VM3404H must be connected to your network. The cable that connects the VM3404H to your LAN plugs in here. See <i>Cable Connection</i> , page 14, for further details

## VM3909H Front View

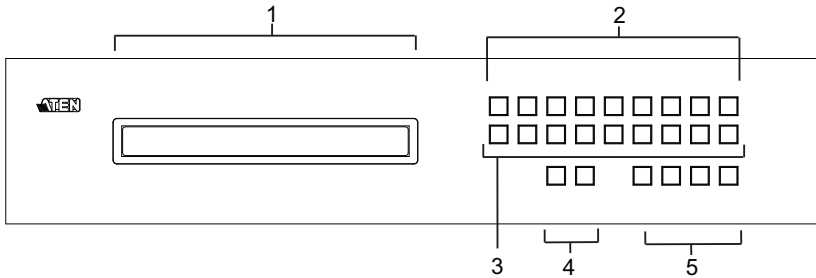

No.	Component	Description
1	LCD display	The LCD display gives a quick view of all port connections, and shows the various options for configuring and operating the VM3909H. For full details, see <i>Main Screen</i> , page 19.
2	input pushbuttons	These pushbuttons refer to the HDMI / HDBaseT input ports found on the VM3909H rear panel. Press to select the input port. These pushbuttons may also correspond to menu options, connection profiles (P1–P9) and so on. <b>Note:</b> The <b>INPUT</b> (1–9) front panel pushbuttons have built-in LEDs that light to indicate they have been selected.
3	output pushbuttons	These pushbuttons refer to the HDMI output ports found on the VM3909H rear panel. Press to select the output port. These pushbuttons may also correspond to connection profiles (P10–P18). <b>Note:</b> The <b>OUTPUT</b> (1–9) front panel pushbuttons have built-in LEDs that light to indicate they have been selected.
4	Prev / Next pushbuttons	These pushbuttons allow you to cycle through the menu options on the LCD display.
5	function pushbuttons	The function pushbuttons ( <b>MENU</b> , <b>PROFILE</b> , <b>ENTER</b> and <b>CANCEL</b> ) are for navigating the LCD built-in configuration utility. For full details, see <i>Front Panel Pushbuttons</i> , page 17. <b>Note:</b> The <b>MENU</b> and <b>PROFILE</b> front panel pushbuttons have built-in LEDs that light to indicate they have been selected.

## VM3909H Rear View

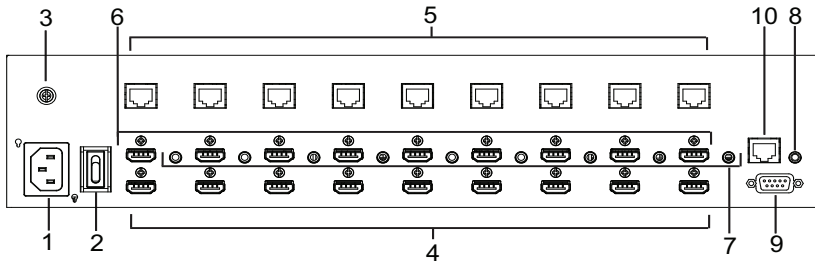

No.	Component	Description
1	power socket	This is a standard 3-pin AC power socket. The power cord from an AC source plugs in here.
2	power switch	This is a standard rocker switch that powers the unit on and off.
3	grounding terminal	The grounding wire attaches here. See <i>Grounding</i> , page 13, for further details.
4	HDMI input ports	The cables from your HDMI source devices plug into these ports.
5	HDBaseT output ports	The cables from your remote HDBaseT display devices or HDBaseT receivers plug into these ports.
6	HDMI output ports	The cables from your local HDMI display devices plug into these ports.
7	IR channel ports	Connect IR receivers / transmitters into the IR channel ports for controlling the source and the display from local or remote locations.
8	IR port	Connect an IR unit via the 3.5 mm mini stereo jacks. IR signals are used to control the VM3909H.
9	RS-232 serial port	Connect a computer or high-end system controller via this serial port.
10	Ethernet port	In order to access the VM3909H's Browser Graphical User Interface (GUI), the VM3909H must be connected to your network. The cable that connects the VM3909H to your LAN plugs in here. See <i>Cable Connection</i> , page 14, for further details

# Chapter 2

## Hardware Setup



1. Important safety information regarding the placement of this device is provided on page 101. Please review it before proceeding.
2. Make sure that the power to all devices connected to the installation are turned off. You must unplug the power cords of any computers that have the Keyboard Power On function.

### Rack Mounting

---

The VM3404H can be mounted in a 19" (1U) system rack and VM3909H can be mounted in a 19" (2U) system rack. For the most convenient front panel pushbutton configuration and operation at the local site, mount the unit at the front of the rack, as follows:

1. Use the M3 x 8 Phillips head hex screws supplied with the mounting kit to screw the rack mount brackets onto the front and back of the unit.

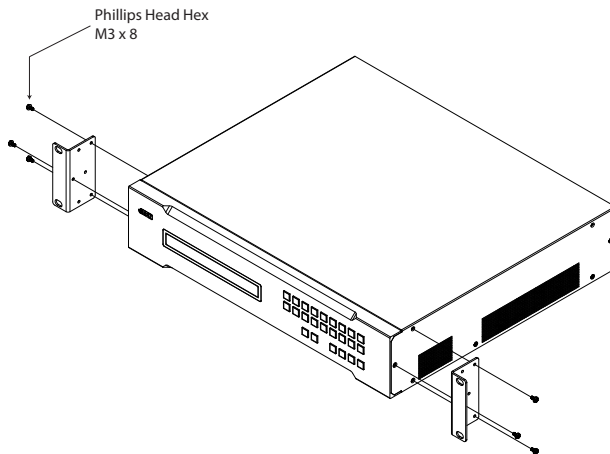

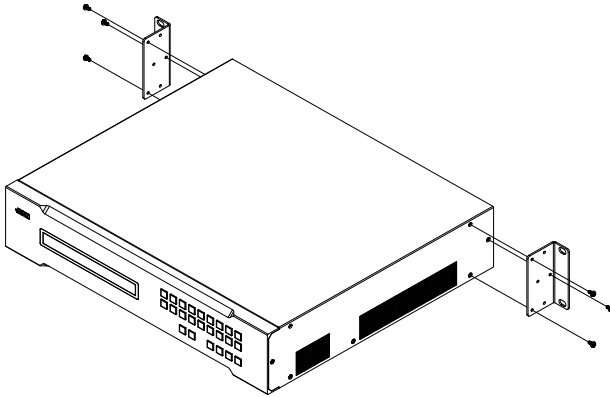

2. Position the unit in the front of the rack and align the holes in the rack mount brackets with the holes in the rack.
3. Screw the rack mount brackets to the rack.

## Grounding

---

To prevent damage to your installation, it is important that all devices are properly grounded.

1. Use a grounding wire to ground the VM3404H / VM3909H by connecting one end of the wire to the grounding terminal, and the other end of the wire to a suitable grounded object.

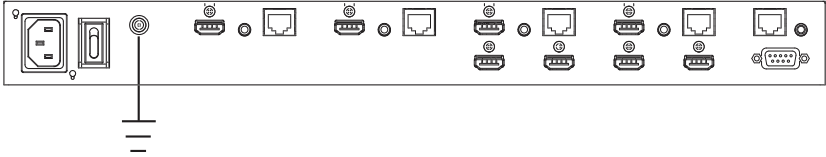

2. Make sure that all devices in your VM3404H / VM3909H installation are properly grounded.

## Cable Connection

---

Installation of the VM3404H / VM3909H is simply a matter of connecting the appropriate cables. Refer to the installation diagram on the following page (the numbers in the diagram correspond to the steps below), and do the following:

1. Use a grounding wire to ground the unit by connecting one end of the wire to the grounding terminal, and the other end of the wire to a suitable grounded object.

---

**Note:** Do not omit this step. Proper grounding helps to prevent damage to the unit from power surges or static electricity.

---

2. Connect up to 4 (VM3404H) or 9 (VM3909H) HDMI video sources to the **HDMI input** ports
3. You can choose one of the following methods to transmit signals over a distance.
  - ◆ Connect up to 4 (VM3404H) or 9 (VM3909H) HDBaseT display devices directly to the **HDBaseT output** ports using an RJ-45 cable.
  - ◆ Connect up to 4 (VM3404H) or 9 (VM3909H) HDMI display devices via an HDBaseT receiver. (Connect the VM3404H / VM3909H to the HDBaseT receiver using an RJ-45 cable. Then connect the receiver to the HDMI display device using an HDMI cable.)
4. (Optional) Connect up to 4 (VM3404H) or 9 (VM3909H) local HDMI display devices to the **HDMI output** ports.
5. Connect IR receivers / transmitters to the **IR channel** ports for controlling source and display devices from local or remote locations.
6. (Optional) To access features on the web interface or use the ATEN Video Matrix Control app (see *Browser Operation*, page 39), plug a Cat 5e cable from the LAN into the VM3404H / VM3909H's **Ethernet** port.
7. (Optional) If you are using the serial control function, use an appropriate RS-232 serial cable to connect the computer or serial controller to the VM3404H / VM3909H's female **RS-232 serial** port.
8. Plug the power cord supplied with the package into the VM3404H / VM3909H's 3-prong AC socket, and then into an AC power source.
9. Connect an IR receiver to the **IR** port for controlling the VM3404H / VM3909H.
10. Power on the VM3404H / VM3909H and all devices in the installation.

## Installation Diagram

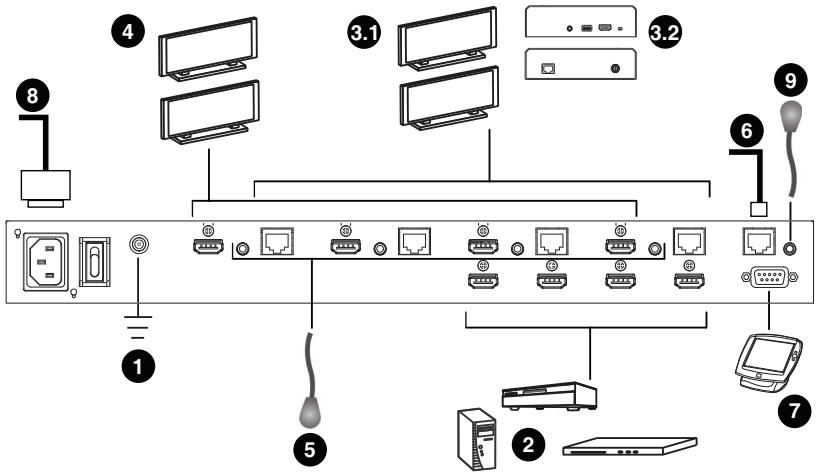

This Page Intentionally Left Blank

# Chapter 3

## Front Panel Configuration

### Overview

---

The VM3404H / VM3909H can be configured and operated locally via the front panel LCD/pushbuttons and IR Remote Control; remotely over a standard TCP/IP connection via graphical user interface (GUI) using a web browser; via a remote terminal session using Telnet; or by an RS-232 serial controller.

The local front panel operation is discussed in this chapter. Web GUI Operation is discussed in Chapter 4, and RS-232 serial control is discussed in Chapter 6.

### Front Panel Pushbuttons

---

The front panel features an LCD display and pushbuttons for convenient operation locally. This allows users to perform operations such as selecting which source shows on which display, viewing the IP settings, configuring the serial port, setting the EDID Mode / CEC / OSD /Output Status, selecting security settings, and loading/saving profiles.

Note the following front panel pushbutton functions:

- ◆ Use the **MENU** pushbutton to access the Menu page options: IP Setting, Serial Port Setting, Operation Mode, Security Mode, and Save to a Profile (see *LCD Menu Organization*, page 23).
- ◆ Use the **PROFILE** pushbutton to switch between the connection profiles which have been added to the Profile List (see *Profile List*, page 41). Pressing this pushbutton for longer than 3 seconds displays the Save to a Profile page (see *Save to a Profile*, page 35).
- ◆ Use the **CANCEL** pushbutton to go back to a previous page, return to the Main Screen, stop or exit an operation.
- ◆ Use the **ENTER** pushbutton to select options and confirm operations.
- ◆ Use the **INPUT / OUTPUT (1–9)** or **(1-4)** pushbuttons to select the Input/Output port. These pushbuttons may also correspond to menu options, connection profiles, and so on.
- ◆ Use pushbuttons **Prev / Next** to navigate the VM3404H / VM3909H menus.

## Enter Password

Upon VM3404H / VM3909H startup, check the front panel LCD to view the loading progress. If the Password screen / LCD Menu fails to load, an error message displays. Reset the unit and try again.

If you are accessing the VM3404H / VM3909H for the first time, the Password screen appears as soon as the LCD loading process is done. Enter the default password 1234 to continue to the Main Screen (see *Main Screen*, page 19).



Additionally, the Password Screen appears if the VM3404H / VM3909H has been configured to require a password for Front Panel operation (see *Security Mode*, page 32).

To enter a password, do the following:

1. In the **Enter Password** field, check that the cursor is at the first asterisk (\*) and flashing.
2. Use the front panel Input Port pushbuttons (1–9) or (1–4) to enter the 4-digit password. After the fourth digit has been entered correctly, the Main Screen displays.
3. Press **Cancel** to clear the password. The digits revert to 4 asterisks and the cursor goes back to the first asterisk.

- 
- Note:**
1. The VM3404H / VM3909H password can be any four digit combination between 1111 to 9999 (VM3909H) or 1111 to 4444 (VM3404H). The default password is 1234.
  2. If you enter an incorrect password, the cursor goes back to the first digit and reverts to flashing. The Incorrect Password message displays at the bottom of the screen, but clears as soon as a new password is entered.
  3. If Password option is Enabled (see *Security Mode*, page 32), the LCD display time-out is 5 minutes by default.
-

## Main Screen

The Main Screen shows the Input ports in the top row, which are tied to the Output ports shown in sequential order (1–9) or (1–4) at the bottom row.



- ◆ The front panel pushbutton label (1–9) or (1–4) corresponds to the **Input** ports and **Output** ports on the unit's rear panel.
- ◆ Use the **Menu** pushbutton to view the LCD Menu (see *LCD Menu Organization*, page 23).
- ◆ Use the **Profile** pushbutton to switch between profile connections (see *Profile List*, page 41).

## Port Switching

From the Main Screen, users can configure the Input-to-Output port connections to associate an Input source device to an Output display.

### Input Port Selection

Use the Input Port pushbuttons to select the Input port you want to configure.



To select which input source displays on each output port, do the following:

1. Press any Input port pushbutton (1–9). The Output port LED(s) tied to the said Input port flash.

In the example below, pressing Input port 1 shows it is tied to Output ports 1 and 2.



- To disconnect an Output port from an Input port, press the corresponding Output port pushbutton.

In the example below, Output port **2** has been disconnected from Input port **1**.

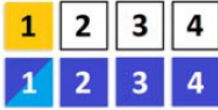

- To switch to another Input port, press any Input port pushbutton. The Output port LED(s) tied to the said Input port flash.

In the example below, pressing Input port **2** shows it is tied to Output ports **3** and **4**.



- To connect Output port **2** to Input port **2** in the example above, then press the Output port **2** pushbutton. The Output port **2** LED will also begin to flash (0.5 sec on, 0.2 sec off). This indicates that Input port **2** is now connected to Output ports **2**, **3** and **4**.



Once the signal from the selected Input port is successfully tied to the Output port, the LEDs turn off and the LCD information is updated.

---

**Note:** 1. Pressing an Input port a second time deselects it.

- Input ports that are not configured or tied to any output port shows **NA** in the LCD screen.
  - Pressing the **Cancel** pushbutton once stops the Input Port Selection operation, and the LCD displays the active setting. Pressing the **Cancel** pushbutton again turns all LEDs off.
  - After 10 seconds of inactivity, all the LEDs turn off.
-

## Output Port Selection

Use the Output Port pushbuttons to select the Output port you want to configure.



To select which output display corresponds to each input source device, do the following:

1. Press any Output port pushbutton (1–9) or (1–4).

In the example below, Output port **1** pushbutton has been pressed.

Available Input ports light up. Because no Input LEDs are flashing, no ports have already been assigned to Output port **1**.



2. If an Output port pushbutton is pressed a second time, it is deselected and the LED turns off.
3. To connect the selected Output port(s) to an Input port, press the Input port pushbutton. to which you want the Output port(s) tied. The newly selected Input port LED flashes (0.5 sec on, 0.2 sec off), and the LCD information is updated.

In the example below, pressing Input port **2** ties it to Output ports **2, 3** and **4**.



4. To switch Output ports **2**, **3** and **4** to another Input port (and disconnect it from Input port **2**), press another Input port pushbutton to which you want it tied.

In the example below, Input port **3** has been pressed and is now connected to Output ports **2**, **3** and **4**.



- 
- Note:**
1. Pressing an Output port a second time deselects it.
  2. Pressing the **Cancel** pushbutton once stops the Output Port Selection operation, and the LCD displays the active setting. Pressing the **Cancel** pushbutton again turns all LEDs off.
  3. After 10 seconds of inactivity, all the LEDs turn off.
-

## LCD Menu Organization

The VM3404H / VM3909H has a built-in configuration utility via the front panel LCD, which can be controlled by pressing the **MENU** and front panel Input pushbuttons (1–9) or (1–4). User can cycle through the menu options, starting from IP Setting page, in the order shown in the table below:

Menu Page	Sub-Menu Page(s)	
IP Setting	IP Address	
	Subnet Mask	
	Gateway	
Serial Port Setting	Baud Rate	9600 / <b>19200</b> / 38400 / 115200
Operation Mode	EDID	<b>Default</b> / Port1 / Remix / Customized
	CEC	On / <b>NA</b>
	OSD	On / NA
	Output Status	Video <b>On</b> / NA Output Resolution 01 - 04 (VM3404H) 01 - 09 (VM3909H)
Security Mode	Mode	<b>None</b>
		Password enable
		Lock Screen
	Change Password	Old Password      New Password
Save to a Profile	Save to a Profile No.	01–08 (VM3404H); 01-18 (VM3909H )
Play/Stop the Profile Schedule		
Turn Video Wall Off		

**Note:** The highlighted values are the default settings of the VM3404H / VM3909H.

## Menu Pushbutton

Press the **MENU** pushbutton to switch between the Main Screen and LCD Menu page. When the Menu is active, the MENU pushbutton's built-in LED lights up:



From the Menu page:

- ◆ Press **1** to go to the IP Setting page (see *IP Setting*, page 24)
- ◆ Press **2** to go to the Serial Port Setting page (see *Serial Port Setting*, page 26)
- ◆ Press **Next** to go to the next page(s) for the sub-menu pages
- ◆ Press **Menu** or **Cancel** to return to the Main Screen

## **IP Setting**

The IP Setting page displays the VM3404H / VM3909H's IP configuration. The values in the LCD Menu are read-only and can be edited via the Browser GUI (*Network*, page 66).

### **IP Address / Subnet Mask**

To view the VM3404H / VM3909H's IP address and Subnet Mask, do the following:

1. From the Menu page, press **1** to see the IP Setting submenu. The IP address and Subnet Mask are then shown.



---

**Note:** The VM3404H / VM3909H default IP address is 192.168.0.60. The default Subnet Mask is 255.255.255.0

---

2. Press **Next** to go to the next page.
3. Press **Menu** to return to the Menu page.
4. Press **Cancel** to return to the previous page without saving.

### **Gateway**

To view the VM3404H / VM3909H's gateway address, do the following:

1. From the Menu page, press **1** to see the IP Setting submenu, then press **Next** to get to the next page. The gateway address displays.



**Note:** The default Gateway is 192.168.0.1.

2. Press **Prev** to go to the previous page.
3. Press **Menu** to return to the Menu page.
4. Press **Cancel** to return to the previous page without saving.

## Serial Port Setting

To configure the VM3404H / VM3909H's baud rate for its serial port connection, select Serial Port Setting from the Menu page.



## Baud Rate

To set the VM3404H / VM3909H's baud rate, do the following:

1. Select **Baud Rate Setting** from the Serial Port Setting submenu by pressing **1**:



2. Press pushbuttons 1–4 to make your selection.



Baud Rate options are:

- ◆ **1:** 9600
- ◆ **2:** 19200
- ◆ **3:** 38400
- ◆ **4:** 115200

---

**Note:** The default baud rate is 19200.

---

3. Press **Menu** to return to the Menu page.
4. Press **Cancel** to return to the previous step without saving.

## Operation Mode

The EDID Mode, CEC, OSD and Output Status features can be configured from the Operation Mode page.

- ◆ EDID (Extended Display Identification Data) is used to have the VM3404H / VM3909H automatically apply a preset video configuration or EDID Mode, which utilizes the best resolution across different monitors
- ◆ Consumer Electronics Control (CEC) allows interconnected HDMI devices to communicate and respond to one remote control
- ◆ The OSD, when enabled for a port, lets an attached display/monitor show real-time port switching information
- ◆ The Output Status shows whether the video/audio of an Output port is turned on or off

To configure the VM3404H / VM3909H's operation mode settings from the Main Screen, use the **Menu** pushbutton to access the Menu page, press **Next** to navigate to the next page, then press pushbutton **1** to access the Operation Mode page.

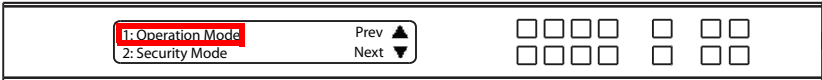

## EDID Mode

To configure the EDID Mode, do the following:

1. From the Operation Mode page, press pushbutton **1**:



*(Continues on next page.)*

2. Press pushbuttons 1–4 to make your selection.



EDID Mode options are:

EDID Option	Description
1: Port1	The EDID from port1 is passed to all video sources.
2: Default	The default EDID is passed to all video sources.
3: Remix	Uses the EDID of each connected display according to its connection when the VM3404H / VM3909H is first powered on, or immediately after pressing 3 to select the Remix option.
4: Customized	Automatically retrieves and saves the EDID settings of a connected monitor/display device to an input source port. This can be configured using the Browser GUI. See <i>Customized Mode</i> , page 70.

3. Press **Menu** to return to the Menu page.
4. Press **Cancel** to return to the previous step without saving.

## CEC

To configure the CEC setting, do the following:

1. From the Operation Mode page, press pushbutton 2:



2. Press pushbuttons (1–9) or (1–4) to enable (**ON**) or disable (**NA**) the CEC feature for the output port. If the port does not support CEC, an **NA** is shown.



**Note:** The default CEC setting is NA.

3. Press **Menu** to return to the Menu page.
4. Press **Cancel** to return to the previous step without saving.

## OSD

The On-Screen Display or OSD feature enables real-time text updates to appear on the display device's screen for any configuration changes made to the Output port via the VM3404H / VM3909H's front panel, IR remote control or Browser GUI.

To configure the OSD setting for each output port, do the following:

1. From the Operation Mode page, press **Next** to go to the next page, then press pushbutton **1**:



2. Press pushbuttons (1–9) or (1–4) to enable (**ON**) or disable (**NA**) the OSD feature for the output port.



---

**Note:** The default OSD setting is On.

---

3. Press **Menu** to return to the Menu page.
4. Press **Cancel** to return to the previous step without saving.

## Output Status

To configure the Output Status settings for each output port, do the following:

1. From the Operation Mode page, press **8** to go to the next page, then press pushbutton **2**:



2. From the Output Status page, press 1 to select Video.



3. Press pushbuttons (1–8) or (1–4) to enable (**ON**) or disable (**NA**) the video/audio of the output port.



**Note:** The default Output Status setting is On.

4. Press **Menu** to return to the Menu page.
5. Press **Cancel** to return to the previous step without saving.

To configure the Output Resolution settings for each output port, do the following:

1. From the Operation Mode page, press 8 or Next to go to the next page, then press pushbutton **2**:



- From the Output Status page, press **2** to select Output Resolution.



- Press pushbuttons (1–8) or (1–4) to select an output port whose resolution will be changed



- Available options include: Native Resolution, 1024x768@60Hz, 1280x720@60Hz, 1280x1024@60Hz, 1400x1050@60Hz, 1600x1200@60Hz, 1920x1080@60Hz, 1920x1200@60Hz, 1280x720@50Hz, 1920x1080@50Hz, 1280x800@60Hz, 720x576@50Hz and 1600x900@60Hz.
- Press **Menu** to return to the Menu page.
- Press **Cancel** to return to the previous step without saving

## Security Mode

The Security Mode page allows users to manage the VM3404H / VM3909H’s security-related settings. Three security modes are available: None, Password Enable and Lock Screen. The VM3404H / VM3909H’s password can also be changed here.

To configure the VM3404H / VM3909H’s password settings from the Main Screen, use the **Menu** pushbutton to access the Menu page, press **8** or **Next** to navigate to the next pages, then press pushbutton **2** to access the Security Mode page.

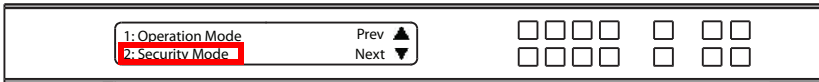

## Mode

1. To change the VM3404H / VM3909H’s security mode, press pushbutton 1 in Security Mode.



2. In the Mode menu, to disable security settings, press pushbutton **1**. The menu will then return to Security Mode. To require a password after the LCD display times out or is powered off/on, press pushbutton **2**. The menu will then return to the home screen.



**Note:** If Password is Enabled, the LCD display’s default time-out is 5 minutes. The VM3404H / VM3909H’s default password is 1234.

3. To enable a lock screen, press **8** or **Next** to navigate to the next page, then press pushbutton **1**. The menu will then return to the home screen. When Lock Screen is enabled, pressing any pushbutton from the home screen will trigger the following message: Please press “**Menu**” to start.

*(Continues on next page.)*



4. Press **Menu** to return to the **Menu** page.
5. Press **Cancel** to return to the previous step without saving.

## Change Password

1. To change the password for accessing the unit, press pushbutton 2.



2. In the Old Password field, the cursor flashes at the first digit. Enter the old password (see *Enter Password*, page 18). If the old password is entered correctly, you can proceed to the next step.



**Note:** If you entered an incorrect password, an error message appears and the cursor goes back to the first digit (flashing). The Incorrect Password message clears as soon as a new digit is entered.

3. In the New Password field, the cursor flashes at the first digit. Enter the new password using the front panel number pushbuttons VM3404H: (1111–8888) or VM3909H: (1111–4444).



4. Re-enter the new password in the following screen. The new password is applied by the VM3404H / VM3909H immediately.



If the password you entered does not match the one entered in the previous screen, an error message appears. Enter the new password correctly.

5. Press **Menu** to return to the Menu page.
6. Press **Cancel** to return to the previous step without saving.

## Save to a Profile

The switch allows users to store up to 8 (VM3404H) or 18 (VM3909H) (numbered P1–P18) different connection profiles that can be saved and recalled later.

The active Input-to-Output port connections on the LCD Main Screen is the configuration saved to a profile. When a user loads a profile, the change is immediate and the profile number is shown on the lower right corner of the LCD screen.

To save a profile once the desired port connections are set, do the following:

1. Press the **Menu** pushbutton to access the Menu page, then **Next** to navigate to the next pages. Press pushbutton **1** to open the select Save to a Profile page.



2. On the page that opens, you are asked to give the profile a number. Use the front panel number pushbuttons to select a profile number into which you want to save the configuration.



**VM3404H:** Options are P1–P8 (when saving a profile via the LCD), where:

- ◆ Input port pushbuttons **1–4** correspond to Profile **P1** to **P4**
- ◆ Output port pushbuttons **1–4** correspond to Profile **P5** to **P8**

**VM3909H :** Options are P1–P18 (when saving a profile via the LCD), where:

- ◆ Input port pushbuttons **1–9** correspond to Profile **P1** to **P9**
- ◆ Output port pushbuttons **10–18** correspond to Profile **P10** to **P18**

3. Press **Enter** to store the configuration – the LCD shows Profile Saved.
4. Press **Menu** to return to the Menu page,
5. Press **Cancel** to return to the previous step without saving.

**Note:** Access the Save to a Profile page quickly by pressing the **Profile** pushbutton for longer than 3 seconds.

## **Play/Stop the Profile Schedule**

Inputting port pushbutton 2 will Play or Stop the active Profile Schedule.



## **Turn Video Wall Off**

If a video wall is currently playing, a submenu will appear.



- ◆ Selecting Turn video wall off will return port assignments to their default (i.e. disassemble the video wall).

## Profile Pushbutton

The **PROFILE** pushbutton lets users conveniently switch between connection profiles that have been saved or added to the Profile List (see *Profile List*, page 41).

When a Profile is in use, its profile number (P1–P18) is shown on the lower right corner of the LCD display.



The Profile pushbutton functions as follows:

- ◆ Press the Profile pushbutton for 1–2 seconds to cycle between profiles stored in the GUI’s Profile List (from 1 up to 18) or (from 1 up to 8) depending on how many are added to the list.
- ◆ Alternatively, after pressing the Profile pushbutton (lights), use the Input/Output pushbuttons to switch to a specific profile (P1 to P18) or (P1 to P8). Note that:
  - ◆ **Input** ports **1–9** or **1–4** correspond to Profile **P1** to **P9** or **P1** to **P4**
  - ◆ **Output** ports **1–9** or **1–4** correspond to Profile **P10** to **P18** or **P5** to **P8** (where Output Port 1=Profile 9, Output Port 2=Profile 10... Output Port 9=Profile 18)

The selected pushbutton lights steady, and the VM3404H / VM3909H immediately applies the port connections configured in the selected profile.

- ◆ When the Profile pushbutton is pressed for 3 seconds or more, the LCD directs to the Save to a Profile page (see *Save to a Profile*, page 35)
- ◆ Press the **Cancel** pushbutton to exit

---

**Note:** If there are no profiles configured on the VM3404H / VM3909H device, an error message “*No Profile List defined. Profile List can be edited via the Web GUI*” is displayed when the Profile pushbutton is pressed.

---

A Profile’s port connections can be edited using the front panel pushbuttons (see *Port Switching*, page 19) or from the *Connections* page of the Browser GUI (see *Connection Profiles*, page 48). Additionally, the Profile List can be configured via the Profile page of the Browser GUI (see *Profile List*, page 41).

This Page Intentionally Left Blank

# Chapter 4

## Browser Operation

### Overview

---

The VM3404H / VM3909H can be configured over a standard TCP/IP connection via its built-in Graphical User Interface (GUI). Because it can be accessed from anywhere over a network or the Internet, operators can easily log in via web browser. Security is ensured by password protection and user-configurable time-out. The VM3404H / VM3909H supports three levels of remote users with various privileges, and up to 32 users can log into the GUI at one time. For full details see the sections that follow.

### Logging In

---

To access the GUI, type the VM3404H / VM3909H's IP address into the address bar of any browser. If a Security Alert dialog box appears, accept the certificate – it can be trusted. The login screen appears:

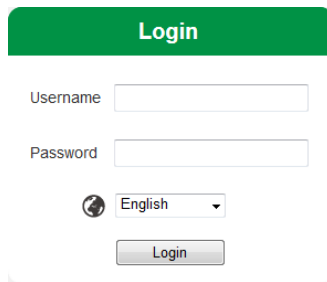

The login screen features a green header with the text "Login". Below the header, there are two text input fields labeled "Username" and "Password". Below the "Password" field is a language selection dropdown menu with a globe icon and the text "English". At the bottom of the form is a "Login" button.

- ◆ The default IP address is **http://192.168.0.60**
- ◆ The default Username and Password are: **administrator / password**
- ◆ Enter the username and password, then click **Login**.
- ◆ Use the drop-down menu to select the GUI language

---

**Note:** 1. The username supports lower case letters only.  
2. The same user can not be logged in simultaneously.

---

## Main Page

The Main Page opens to the **Profile List**. This is where you configure the input to output connections by creating profiles. The page is divided into three parts: the *Menu Bar*, *Profile List*, and *Profile Scheduling*.

The screenshot displays the ATEN VM3404H 4X4 HDMI HDBaseT Lite Matrix Switch main page. The top navigation bar features the ATEN logo, the device model, and a 'Settings' icon. Below this, there are links for 'Import Profiles' and 'Export Profiles', along with a user greeting 'Hi, administrator.' and a 'Logout' button. The main content area is titled 'PROFILE LIST' and includes a 'Delete' button. A sub-section for 'Show OSD' and 'Blank All' is visible. The profile list consists of a grid of profile cards. The first card, '[Profile8] Profile\_08', is highlighted and shows a 2x2 grid. Other cards are labeled '[Profile 1] Untitled' through '[Profile 7] Untitled' and '[Profile 8] Profile\_08'. The bottom section is labeled 'PROFILE SCHEDULING' and contains a copyright notice: 'Copyright © 2016 ATEN International Co., Ltd.'

## Menu Bar

The Menu Bar consists of the *Settings* icon and *Logout* button.

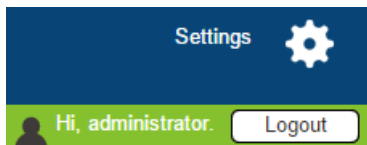

- ◆ Click **Settings** to enter the System Settings (see page 59).
- ◆ Click the **Logout** button to log out of the GUI.

## Profile List

The *Profile List* lets you configure the input to output port connections by creating profiles to use. You can store up to 8/18 differently configured profiles that can be saved and played later by two methods: locally via the unit's front panel pushbuttons and via the web GUI.

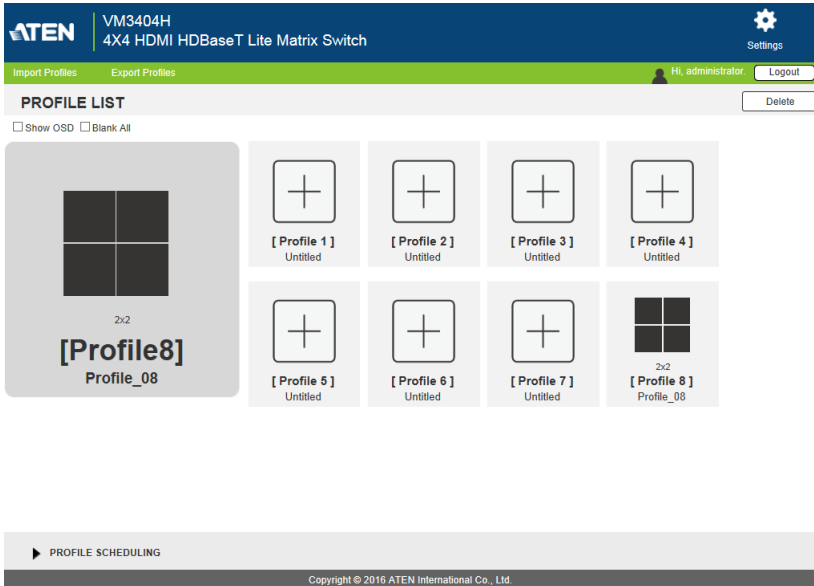

### Adding/Playing a Profile

To configure a new or existing connection profile:

1. From the Profile List, click an empty or existing **[Profile]** icon.
2. For a new profile, select the profile type:



Digital Signage

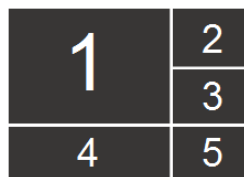

Video Wall

**Digital Signage:** Select this option for video that is displayed independently on separate monitors (page 48).

**Video Wall:** Select this option for monitors that are displayed together - tiled or as a large screen (page 51).

3. Configure the input to output connections for a Digital Signage (**page 48**) or Video Wall (**page 51**) profile.
4. Select the profile and click **Apply**.

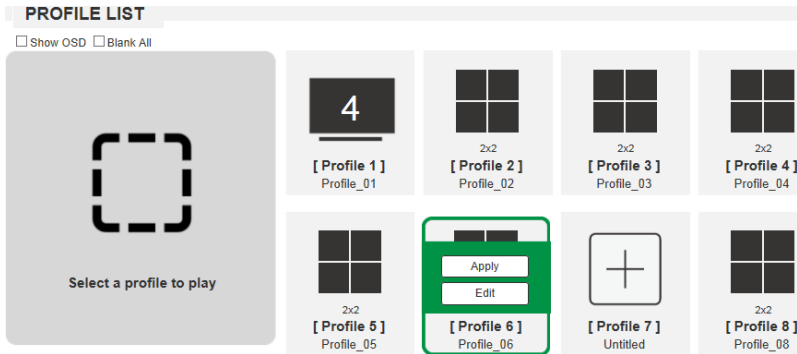

5. The profile appears in the large **Play** window and the connections start:

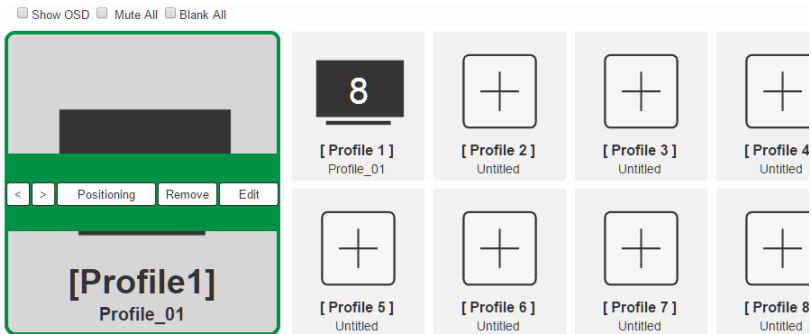

**Note:** More information about the Profile List is provided on the next page.

## Importing / Exporting a Profile

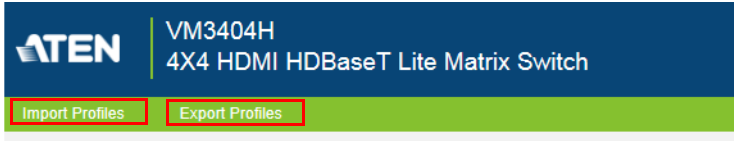

To export the VM3404H / VM3909H's connection profiles, do the following:

1. Click **Export Profiles**. A configuration file will then begin downloading.

To import connection profiles to the VM3404H / VM3909H, do the following:

1. Click **Import Profiles**.
2. Browse to the configuration file, select it and click **Open**.

---

**Note:** Importing a connection profile database will overwrite the current profiles.

---

## Profile List Options

Clicking a *Profile* or the *Play* window opens a pop-up menu with options, as shown on the next page.

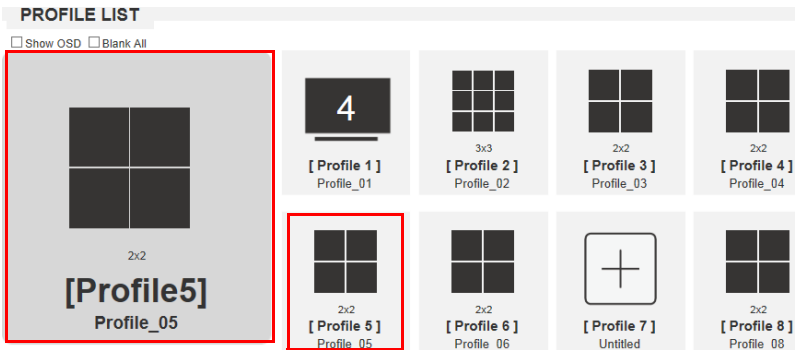

## Profile

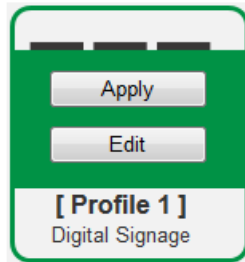

Option	Description
Apply	Click <b>Apply</b> to put the profile in the Play window. This allows you to start the profile connections.
Edit	Click <b>Edit</b> to configure the profile's input to output connections.

## Play Window

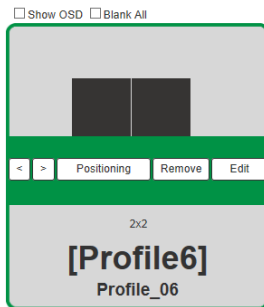





Option	Description
On Sequence	<b>On Sequence</b> will appear when a profile schedule is playing (see page 43).
<	Click < to go back to the previous profile in the sequence, when Profile Scheduling is in use. Only available with <i>On Sequence</i> .
>	Click > to advance to the next profile in the sequence, when Profile Scheduling is in use. Only available with <i>On Sequence</i> .
Positioning	Click <b>Positioning</b> to open a window that allows you to adjust the image position on each display. For Video Wall profiles, you can also set the Bezel Dimension, which is the frame thickness between each display.
Remove	Removes the profile from the Play window.

Option	Description
Edit	Click <b>Edit</b> to configure the profile's input to output connections.
Show OSD	Check <b>Show OSD</b> to display the OSD on all connected displays. The OSD will be displayed until the user closes it manually.
Blank All	Check <b>Blank All</b> to turn off the video to all displays.

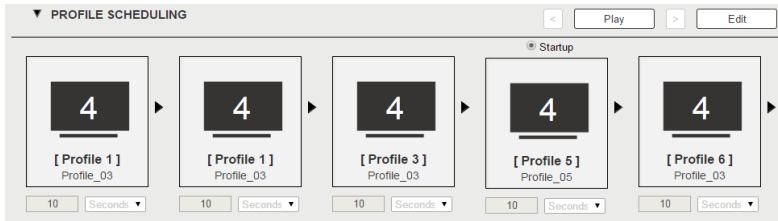
## Profile Scheduling

*Profile Scheduling* is located below the Profile List. Scheduling allows you to queue and play connection profiles in sequence for a specific amount of time.



Option	Description
	Click to edit profile schedule.
	Click to play profile schedule.
	Click to stop profile schedule.
	Click to change to next or previous profile when a profile schedule is playing.

After selecting **Edit**, you will be presented with the following options.

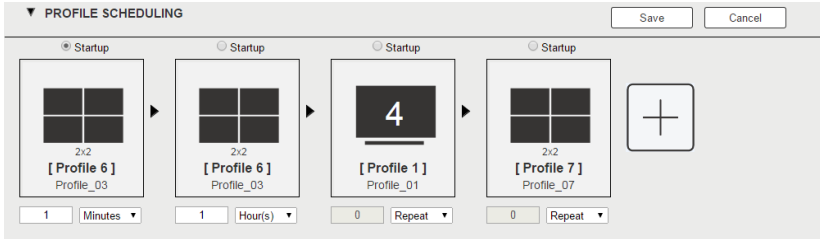

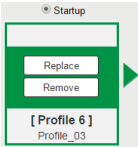
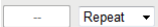
Option	Description
	Click to add profiles to the schedule in the order to be played, left to right, then set the amount of time each profile plays.
	Click a profile for a pop-up menu to appear: <ul style="list-style-type: none"> <li>◆ Select <b>Startup</b> to use the profile as the starting point for the schedule.</li> <li>◆ Click <b>Replace</b> to replace the selected profile with another profile.</li> <li>◆ Click <b>Remove</b> to delete the profile from the schedule.</li> <li>◆ Use &lt; &gt; to change the profile's position in the schedule.</li> </ul>
	Use the drop-down menu to select the duration (Hours, Minutes, or Seconds) and enter the amount of time for the profile to play. After the time expires, the schedule switches to the next profile.  Use <b>Repeat</b> to stop switching between schedules and stay on the currently selected profile. If <b>Repeat</b> isn't used, the schedule will loop back to the first profile. If <b>Repeat</b> is used, a specific number of hours, minutes and seconds cannot be set and later profiles will not be played.
Save	Click <b>Save</b> to save the schedule as it appears. After saving, the Profile Scheduling window will close.  When a Profile Schedule is playing the <i>On Sequence</i> box will appear in the Play window.
Cancel	Click <b>Cancel</b> to discard changes and return to the Profile Schedule page.

## Connection Profiles

There are two types of profiles: *Digital Signage* and *Video Wall*. **Digital Signage** profiles are for displays where video is viewed on separate monitors. **Video Wall** profiles are for displays that are tiled together, where multiple monitors form one large screen – in various arrangements.



### Digital Signage Profile

Each icon represents an output port and the connected display. The large number is the **Input** port selected for the display. The small number (upper-left corner) is the **Output** port for the display. Click the icons to select options.

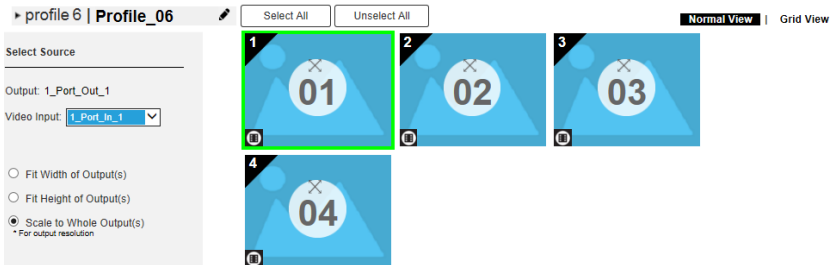

- ◆ Select icons to choose the **Video Input** from the *Select Source* menu.
- ◆ Click the PEN icon or name to edit the profile name.
- ◆ Click **Select All** to select all outputs.
- ◆ Click **Unselect All** to unselect all outputs.
- ◆ Click **Save** to save or **Save as** to save as a different profile number.
- ◆ Click **Test** to view a sample of the profile.
- ◆ Click **Save and Apply** to save and automatically apply the current profile to the play window.
- ◆ Click *Grid View* to use an alternate method for configuring connection profiles (see page 49).

## Output Icon

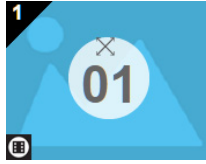

Option	Description
Output Icon	Click an Output icon(s) to highlight it in green and use the <i>Select Source</i> menu to set the video options (see <i>Select Source</i> below). The large number is the <b>Video Input</b> port selected for the display. The small number (upper-left corner) is the <b>Output</b> port of the display.
Video 	Click the <b>video</b> icon to turn the video off/on.

## Select Source

Select Source

---

Output: 1 2

Video Input:

Fit Width of Output(s)  
 Fit Height of Output(s)  
 Scale to Whole Output(s)  
\* For output resolution

Option	Description
Select Source	The Select Source menu appears when you click an <b>Output</b> icon.
Video Input	Use the drop-down menu to select the <b>Video Input</b> port.
Radio Button	<ul style="list-style-type: none"> <li>◆ <b>Fit Width of Output(s)</b>: fits the video to the width of the display.</li> <li>◆ <b>Fit Height of Output(s)</b>: fits the video to the height of the display.</li> <li>◆ <b>Scale to Whole Output(s)</b>: fits the video on the entire display.</li> </ul>

## Grid View

The Traditional View allows you to select the **Input to Output** connections using a simple grid.

**Output Port** \* Uncheck to blank a display.

o01 o02 o03 o04 o05 o06 o07 o08 o09

**Input Port**

<input type="radio"/> i01									
<input type="radio"/> i02									
<input type="radio"/> i03									
<input type="radio"/> i04									
<input type="radio"/> i05									
<input type="radio"/> i06									
<input type="radio"/> i07									
<input type="radio"/> i08									
<input type="radio"/> i09									

- ◆ From an *Output Port* column, click a box to select its **Input Port**. The box will turn yellow.
- ◆ **Uncheck** an *Output Port* box to disable the video for that Output Port. The column will turn dark grey.
- ◆ **Check** an *Output Port* box to enable the video for that Output Port.
- ◆ Click **Test** to play the current profile without saving.
- ◆ Click **Save & Apply** to save a profile and begin playing it.
- ◆ Click **Save** to save the profile.
- ◆ Click **Save as** to save the profile as a different profile number.
- ◆ Click **Cancel** to undo all unsaved changes.

## Output Options

For instructions on the *Output Options* page, see *Output Option*, page 58.

## Video Wall Profile

- Note:** 1. This feature is only available when the VM3404H / VM3909H is used in conjunction with the VE805R/VE816R.
2. The VE816R is only supported on VM3404H / VM3909H using firmware version 2.2.213 or later.

Each blank icon represents an Output port and the connected display. Use the icons to create Independent and Grouped Outputs. **Independent** Outputs will display video on a single monitor. **Grouped** Outputs will display video across multiple monitors as one large screen.

## Video Wall Options

- ◆ Click an icon to choose its **Output** and **Video Input** from the *Display Preference* menu (see page 55).
- ◆ Click multiple icons to Group Outputs (see *Grouping*, page 54) and choose the **Video Input** from the *Display Preference* menu.
- ◆ Use **+** next to **Display Layout \_1** to create additional layouts under the same profile.
- ◆ Click the PEN icon or name to edit the profile name.
- ◆ Click **Select All** to select all outputs.
- ◆ Click **Unselect All** to unselect all outputs.
- ◆ Click **Test** to play the current profile without saving.

- ◆ Click **Save & Apply** to save the profile and put it in the Play window (see page 44).
- ◆ Click **Save** to save the profile.
- ◆ Click **Save as** to save the profile as a different profile number.
- ◆ Click **Cancel** to discard changes and return to the Profile List.

## Number of Displays / Output Order / Bezel Dimensions

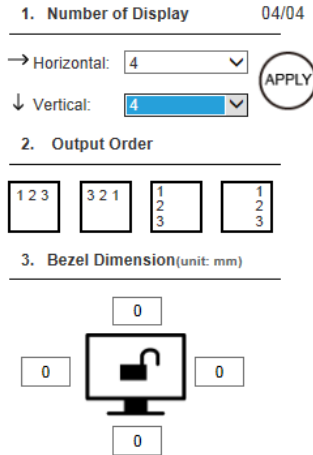

Option	Description
Number of Displays	Use the <i>Horizontal</i> and <i>Vertical</i> drop-down menu to select the number of displays that make up the video wall (a maximum of 64* are supported). Match this to the physical layout of the displays. Click <b>Apply</b> to set the layout. <b>Note:</b> To achieve a maximum number of displays requires the use of sixteen VM3404H / VM3909H switches.
Output Order	Automatically assign output ports by selecting one of the following options: Left to right (top to bottom), right to left (top to bottom), top to bottom (left to right) or top to bottom (right to left).
Bezel Dimension	Use the four boxes to increase/decrease the frame size for each active display.
Monitor Lock / Unlock	Click the monitor icon to <b>Lock</b> the (4) bezel settings, so that when one size is changed they all change. Click the monitor icon to <b>Unlock</b> the (4) bezel settings, so that each size can be set independently.

## Null Input



Option	Description
Null Icon	<p>Click Null Input icons to highlight icons in green and use the Display Preferences menu to set the video options (see <i>Display Preferences</i>, page 55).</p> <p>Select a <b>single</b> icon to set the <b>Output</b> and <b>Video Input</b> for an independent display (see <i>Independent Output</i>, page 53).</p> <p>Select <b>multiple</b> icons and set the <b>Video Input</b> to group displays as one screen (see <i>Grouping</i>, page 54). <i>You must first set the Output port for each icon.</i></p>

## Independent Output

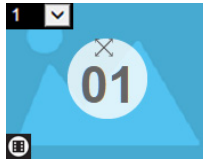

Option	Description
Independent	<p>Independent Outputs are displays that have their own <b>Video Input</b> and <b>Output</b> selected. Independent Outputs:</p> <ul style="list-style-type: none"> <li>◆ Display their own video</li> <li>◆ Icons have their own color and Video Input</li> </ul> <p>Select an Independent Output and use the <i>Display Preferences</i> menu to select the <b>Video Input</b> (see page 55).</p>

## Grouping



Option	Description
Grouping	Click multiple icons to Group Outputs (highlighted in green) and click → ← to group the displays into one screen. Use the <b>Display Preferences</b> menu to select the <b>Video Input</b> for the group - each Output icon in the Group will appear with the same Video Input number and icon color (see page 54).
Ungroup	Select a group and click ← → to ungroup the displays.

## Group

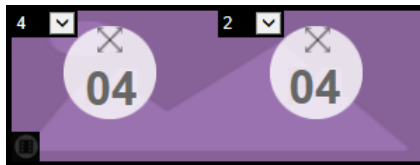

Option	Description
Group	<p>A <b>Group</b> (of Outputs) shares the same <b>Video Input</b> and displays the video together as one large screen. A Group of Outputs:</p> <ul style="list-style-type: none"> <li>◆ Displays video across multiple monitors to form one screen</li> <li>◆ Icons have the same color and Video Input number.</li> <li>◆ Select a Group and use the <i>Display Preferences</i> menu to select the <b>Video Input</b>.</li> <li>◆ To group outputs see <i>Grouping</i>, page 54.</li> </ul>

## Display Preferences

**Display Preference**

---

Output:  ▼

Video Input:  ▼

Fit Width of Output(s)  
 Fit Height of Output(s)  
 Scale to Whole Output(s)

Option	Description
Display Preferences	Click Output icons for the Display Preferences menu to appear– to select the <b>Output</b> and/or <b>Video Input</b> port.
Output	Use the drop-down menu to select the <b>Output</b> port (Independent and single Blank icons only). If you select multiple displays the output ports selected will appear here. You can use the output icon's drop-down menu to change the output port for the display.
Video Input	Use the drop-down menu to select the <b>Video Input</b> port.
Radio Button	<ul style="list-style-type: none"> <li>◆ <b>Fit Width of Output(s)</b>: fits the video to the width of the display.</li> <li>◆ <b>Fit Height of Output(s)</b>: fits the video to the height of the display.</li> <li>◆ <b>Scale to Whole Output(s)</b>: fits the video on the entire display.</li> </ul>

### Video Wall Example 1

The example below shows a video wall with 4 displays.

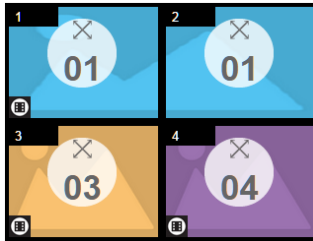

- ◆ Each Group and Independent Output has a unique color.
- ◆ This video wall has 1 **Group** and 2 **Independent** displays.
- ◆ The Group will show **Video Input 01** across both displays as one large screen.
- ◆ The Independent displays will show the video from their own **Video Input** – 03 and 04.

### Video Wall Example 2

The example below shows a video wall with 9 displays.



- ◆ Each Group and Independent Output has a unique color.
- ◆ This video wall has 2 *Groups* and 2 *Independent* displays.
- ◆ The *Blue* Group will show **Video Input 01** across three displays as one large screen.
- ◆ The *Green* Group will show **Video Input 02** across four displays as one large screen
- ◆ The *Pink* Independent display will show the video from it's own **Video Input** - 03

- ♦ The *Brown* Independent displays will show the video from it's own **Video Input – 04**.
- ♦ Add Display Layouts to create separate video walls (see *Video Wall Options*, page 51).

## Output Option

The *Output Option* page is used to configure the Video Controls.

### Video Control's

The *Video Control* page allows you to set Seamless Switch options which determine how a display performs when the Input port is changed.

Port	*Seamless Switch	Transition	Period	Scale Resolution
	Apply to All	Apply to All	Apply to All	Apply to All
Port1	<input checked="" type="checkbox"/> ON	<input type="checkbox"/> OFF	---	1920x1080@60HZ
Port2	<input checked="" type="checkbox"/> ON	<input type="checkbox"/> OFF	---	1920x1080@60HZ
Port3	<input checked="" type="checkbox"/> ON	<input type="checkbox"/> OFF	---	1920x1080@60HZ
Port4	<input checked="" type="checkbox"/> ON	<input type="checkbox"/> OFF	---	1920x1080@60HZ

\*The Seamless Switch function cannot be turned off from the video wall editor.

The *Transition*, *Period* and *Scale Resolution* apply only when Seamless Switching is on.

- ◆ **Seamless Switch:** Turning *Seamless Switch* on removes the video distortion and delay seen when an Input port is switched.
  - ◆ Use the drop-down menu to apply options to all ports, or the On/Off button to enable/disable Seamless Switching per port.
- ◆ **Transition:** Allows you to fade the video display when the Input port is changed. Use the period option to set the fade speed.
  - ◆ Use the drop-down menu to apply options to all ports, or On/Off button to enable/disable Transition per port.
- ◆ **Period:** Sets the fade speed for the Transition option.
  - ◆ Use the drop-down menu to apply an option (*Slow*, *Normal*, or *Fast*) to all ports, or lower drop-down menus to apply options per port.
- ◆ **Scale Resolution:** Forces the port to scale the video displayed to the selected resolution.
  - ◆ Use the top drop-down menu to apply an option to all ports, or lower drop-down menus to apply options per port.
- ◆ Click **Test** to play current profile without saving.
- ◆ Click **Save & Apply** to save a profile and begin playing it.
- ◆ Click **Save** to save the profile.
- ◆ Click **Save as** to save the profile as a different profile number.
- ◆ Click **Cancel** to undo all unsaved changes.

## System Settings

Click the *Settings* link from the Main page for the System Settings to open on the **General** page:

The screenshot shows the ATEN VM3404H web interface. The header includes the ATEN logo, device name 'VM3404H 4X4 HDMI HDBaseT Lite Matrix Switch', and a 'Profile List' button. The user is logged in as 'Hi, administrator.' with a 'Logout' button. The navigation menu includes 'General', 'User Account', 'Port Name', 'Network', 'EDID', and 'Maintenance'. The 'General' page is active, showing 'Fan status' with a temperature of 36°C and two fans (Fan 1 and Fan 2) with a 'Fan Speed' dropdown set to 'Auto'. Below this is 'Device Info' with a table:

Device	Model Name	F/W Version	
Video Matrix	VM3404H	V1.2.345	
Port1	N/A	N/A	-X
Port2	N/A	N/A	-X
Port3	N/A	N/A	-X
Port4	N/A	N/A	-X

Below the table is the 'Other' section with 'Language' set to 'English' and 'Baud Rate' set to '115200'. At the bottom are 'Save' and 'Cancel' buttons.

- ◆ The *General* page allows you to view and set Serial, Fan, Language and Baud Rate Settings. Here you can also view Temperature, Fan and Slot Information.
- ◆ The *User Account* page allows you to add and edit user accounts.
- ◆ The *Port Name* page allows you to name each input and output port.
- ◆ The *Network* page allows configuration of the network settings.
- ◆ The *EDID* page is used to set the EDID modes.
- ◆ The *Maintenance* page is for upgrading the device's firmware.
- ◆ The *IR Channel* page allows you to set the IR and channel settings\*.
- ◆ The *HDCP* page lets users view and set HDCP key settings.
- ◆ The *OSD/CEC* page allows users to control port OSD and CEC settings.
- ◆ Click **Profile List** to return to the Main page.

## General

The General page has three sections: Fan Status, Device Info, and Other.

### Fan status

35 °C



Fan Speed Auto ▾

### Device Info

Device	Model Name	F/W Version
Video Matrix	VM3404H	V1.2.345
Port1	N/A	N/A
Port2	N/A	N/A
Port3	N/A	N/A
Port4	N/A	N/A

### Other

Language English ▾      Baud Rate 115200 ▾

## Fan Status

- ◆ This section displays the internal temperature and status of the cooling fans.
- ◆ Fans rotate to indicate they are working.\*

**Note:** Use the drop down menu to select fan speed: Auto, High, Medium and Low. If the fans have stopped working or are switched off, they will appear as follows. The fan module will then need to be replaced or reset.



## Device Info

- ◆ This section lists the Video Matrix ports, Model Name, Firmware Version, and connection status.

## Other

- ◆ Use the **Language** drop - down menu to select a preferred user interface language. Options include: English, French, German, Italian,

Japanese, Portuguese, Russian, Spanish, Simplified Chinese, and traditional Chinese.

- ◆ Use the **Baud Rate** drop-down menu to select a serial port setting options include 9600, 19200, 38400 and 1152000

## User Account

The *User Account* page lets you add, edit, or delete users and change the password for accessing the VM3404H / VM3909H's GUI.

**Note:** This is an Administrator only function.

User Name	Level	Description
administrator	Administrator	Default_User
user_1	Basic User	User_Account

- ◆ **Add account** – Click the *Add account* button to add another user to the list. The VM3404H / VM3909H supports up to 32 users at one time (see page 63 for more details).
- ◆ **Edit** – Click the *Edit* button to change user information. This option allows an Administrator to edit individual accounts.

User Name	Level	Description
<a href="#">Edit</a> 111111	Administrator	111111 
<a href="#">Edit</a> 12345	Administrator	
<a href="#">Edit</a> administrator	Administrator	Default_user

- ◆ **Edit** – Click to rename the user account, set the password, add a description, and set the user's permission level (see page 64 for more details).
- ◆ **Delete** – Removes the user account.



- ◆ The default username and password are: administrator/password.

## Add Account

Use the Add Account / Edit buttons to create a user account, set the user's password, add a description, and set the user's permission level (see , page 63) when accessing the VM3404H / VM3909H's GUI.

Add account

Username

Password

Confirm Password

Please enter 5-16 characters without \*+!@#%&'<?> space &

Description

Permission Level

Administrator Open/Save Profiles, Manage users

Advanced User Open/Save Profiles

Basic User Open Profiles

- ◆ Fill in a username or edit an existing one.
- ◆ Enter a password and re-type the password to confirm.

---

**Note:** Usernames and passwords accept multi-lingual characters, and must be 5–16 alphanumeric characters (excluding ;:=[+/?\|). Passwords are case sensitive. Usernames only support lower case letters.

---

- ◆ Add or edit the description for the user.
- ◆ Select the permission level that you want to grant the user (see page 64).
- ◆ Click **Create User** to save the data.
- ◆ Click **Cancel** to discard the changes and exit.
- ◆ If a user is logged into the VM3404H / VM3909H's GUI, their user settings cannot be edited, and the fields in this screen are grayed out.

## **Permission Level**

At the bottom of the New/Edit User page is the permission section, which is used to set a user's permission level.

The screenshot shows a web form titled "Add account" with a green header. The form contains several input fields: "Username", "Password", "Confirm Password", and "Description". Below the "Description" field is the "Permission Level" section, which is highlighted with a red rectangular box. This section contains three radio button options: "Administrator Open/Save Profiles, Manage users", "Advanced User Open/Save Profiles", and "Basic User Open Profiles". The "Basic User Open Profiles" option is selected. Below the radio buttons are two buttons: "Create User" and "Cancel". A small note above the "Description" field reads: "Please enter 5-10 characters without \*+@=#:~!<>?() space &".

The three available permission levels are as follows:

- ◆ **Administrator** – this level provides full access and control of the VM3404H / VM3909H, in addition to full User Management privileges.
- ◆ **Advanced User** – this level provides full access and control with no User Management privileges.
- ◆ **Basic User** – this level only provides basic functions (connections and open profiles).

## Port Name

The *Port Name* page lets users name the Input and Output ports for easy identification.

Please enter characters without using "+/@=|:~\*~<~>?()\&

Output Port	
Port1	01_ <input type="text" value="Port_Out_1"/>
Port2	02_ <input type="text" value="Port_Out_2"/>
Port3	03_ <input type="text" value="Port_Out_3"/>
Port4	04_ <input type="text" value="Port_Out_4"/>

Input Port	
Port1	01_ <input type="text" value="Port_In_1"/>
Port2	02_ <input type="text" value="Port_In_2"/>
Port3	03_ <input type="text" value="Port_In_3"/>
Port4	04_ <input type="text" value="Port_In_4"/>

- ◆ To name an Input/Output port, enter a descriptive name of up to 16 characters (including 0-9, a-z, A-Z, \_, -) in the corresponding field.
- ◆ To change an Input/Output port's name, enter another value and click **Save**.
- ◆ Click **Cancel** to reset all stored names.

---

**Note:** The Input and Output port names can be the same.

---

## Network

The *Network* page lets you configure the VM3404H / VM3909H's IP settings for connecting to it via the web GUI, and enable/disable Telnet.

<b>DHCP</b>	<input type="radio"/> Enable	<input checked="" type="radio"/> Disable
<b>IP Address</b>	<input type="text"/>	
<b>Subnet Mask</b>	<input type="text"/>	
<b>Default Gateway</b>	<input type="text"/>	
<b>Website Timeout</b>	<input type="text" value="N/A"/> ▾	
<b>MAC Address</b>	00:10:74:BB:00:16	
<b>Telnet</b>	<input checked="" type="radio"/> Enable	<input type="radio"/> Disable
	<input type="button" value="Save"/>	<input type="button" value="Cancel"/>

**Enable** DHCP to allow the DHCP server to assign an IP address to the VM3404H / VM3909H. Select **Disable** to enter your own static IP address settings for the device.

Click **Cancel** to use the following default values:

- ◆ IP Address – **192.168.0.60**
- ◆ Subnet Mask – **255.255.255.0**
- ◆ Default Gateway – **192.168.0.1**
- ◆ Website Timeout\* – N/A, 5, 10, 30, 60 minutes
- ◆ Telnet enabled (checked)

Enter the values, then click **Save**. Changes may take a few seconds and after refreshing the page automatically redirects you to the IP address specified.

---

\* This option controls how long an inactive web connection stays logged into the VM3404H / VM3909H. Any changes will take effect immediately. The default setting is 5 minutes.

---

## EDID Settings

The *EDID Setting* page lets users view and select an EDID Mode so that the VM3404H / VM3909H can use the best resolution for its display(s).

EDID Mode	EDID & CEA Description	
<input checked="" type="radio"/> ATEN Default <input type="radio"/> Port1 Mode <input type="radio"/> Remix <input type="radio"/> Customized <input type="button" value="Apply"/> Port EDID Status Port 1 ATEN Default Port 2 ATEN Default Port 3 ATEN Default Port 4 ATEN Default	<b>EDID</b> 1. Vendor/Product Identification 2. EDID Structure/Revision 3. Basic Display/Feature 4. Color Characteristics 5. Established Timings 6. Standard Timings 7. Detail Timing/Display Description 1 8. Detail Timing/Display Description 2 9. Monitor Description 10. Monitor Description  <b>CEA</b> 1. Display Support 2. Video Data 3. Audio Data 4. Speaker Allocation 5. Vendor Specific Data	Model ID: 0x0001 Manufacturer ID: ATN Serial Number: 0x0000275B Manufacture Date: 2014 Week 23 Week of Manufacture: 23 Year of Manufacture: 2014

**Note:** The EDID Mode can also be selected via the Front Panel pushbuttons – see *LCD Menu Organization*, page 23.

Extended Display Identification Data (EDID) is a data format that contains a display's basic information and is used to communicate with the video source/system.

## EDID Mode

In the left panel of the page, users can select a pre-configured EDID Mode using the **EDID Mode** radio buttons.

EDID Mode	EDID & CEA Description				
<input checked="" type="radio"/> <b>ATEN Default</b> <input type="radio"/> Port1 Mode <input type="radio"/> Remix <input type="radio"/> Customized <input type="button" value="Apply"/>	<table border="1"> <tr> <td> <b>EDID</b>            1. Vendor/Product Identification            2. EDID Structure/Revision            3. Basic Display/Feature            4. Color Characteristics            5. Established Timings            6. Standard Timings            7. Detail Timing/Display Description 1            8. Detail Timing/Display Description 2            9. Monitor Description            10. Monitor Description         </td> <td>           Model ID: 0x0001            Manufacturer ID: ATN            Serial Number: 0x0000275B            Manufacture Date: 2014 Week 23            Week of Manufacture: 23            Year of Manufacture: 2014         </td> </tr> <tr> <td> <b>CEA</b>            1. Display Support            2. Video Data            3. Audio Data            4. Speaker Allocation            5. Vendor Specific Data         </td> <td></td> </tr> </table>	<b>EDID</b> 1. Vendor/Product Identification 2. EDID Structure/Revision 3. Basic Display/Feature 4. Color Characteristics 5. Established Timings 6. Standard Timings 7. Detail Timing/Display Description 1 8. Detail Timing/Display Description 2 9. Monitor Description 10. Monitor Description	Model ID: 0x0001 Manufacturer ID: ATN Serial Number: 0x0000275B Manufacture Date: 2014 Week 23 Week of Manufacture: 23 Year of Manufacture: 2014	<b>CEA</b> 1. Display Support 2. Video Data 3. Audio Data 4. Speaker Allocation 5. Vendor Specific Data	
<b>EDID</b> 1. Vendor/Product Identification 2. EDID Structure/Revision 3. Basic Display/Feature 4. Color Characteristics 5. Established Timings 6. Standard Timings 7. Detail Timing/Display Description 1 8. Detail Timing/Display Description 2 9. Monitor Description 10. Monitor Description	Model ID: 0x0001 Manufacturer ID: ATN Serial Number: 0x0000275B Manufacture Date: 2014 Week 23 Week of Manufacture: 23 Year of Manufacture: 2014				
<b>CEA</b> 1. Display Support 2. Video Data 3. Audio Data 4. Speaker Allocation 5. Vendor Specific Data					
Port EDID Status Port 1 ATEN Default Port 2 ATEN Default Port 3 ATEN Default Port 4 ATEN Default					

Select the EDID Mode to use and click **Apply**. The VM3404H / VM3909H uses the settings configured for that EDID mode.

Options are:

- ◆ **ATEN Default:** All ports' EDID are the same as the hardware default EDID.
- ◆ **Port 1 Mode:** All ports' EDID are the same as Port1's EDID.
- ◆ **Remix:** All ports' EDID use the best display resolution.
- ◆ **Customized:** See Customized Mode, see page 70.

## EDID & CEA Description

The right panel of the screen lets users view the configuration of the *EDID* and *CEA* Modes selected:

The screenshot shows a web-based configuration interface for EDID and CEA modes. It is organized into three columns:

- EDID Mode:** Contains radio buttons for 'ATEN Default' (selected), 'Port1 Mode', 'Remix', and 'Customized'. Below these is an 'Apply' button and a section for 'Port EDID Status' with four ports, each set to 'ATEN Default'.
- EDID & CEA Description:** A central list of configuration items. Under 'EDID', items 1 through 10 are listed, with '1. Vendor/Product Identification' selected. Under 'CEA', items 1 through 5 are listed.
- Details Panel:** A box on the right showing the details for the selected EDID item (1). The details are: Model ID: 0x0001, Manufacturer ID: ATN, Serial Number: 0x0000275B, Manufacture Date: 2014 Week 23, Week of Manufacture: 23, and Year of Manufacture: 2014.

- ◆ From the left column, click the option that you want to view and/or edit. There are two categories: **EDID** (Extended Display Identification Data) and **CEA** (Consumer Electronics Association).
- ◆ When you highlight the menu items on the left column, the right column displays the current settings for the corresponding EDID configuration. Some of the screens are read-only.
- ◆ See *EDID Settings*, page 67 for more information on these two columns.

## Customized Mode

Use the *Customized* Mode to automatically retrieve and save the EDID settings of a connected monitor/display device to an input source port.

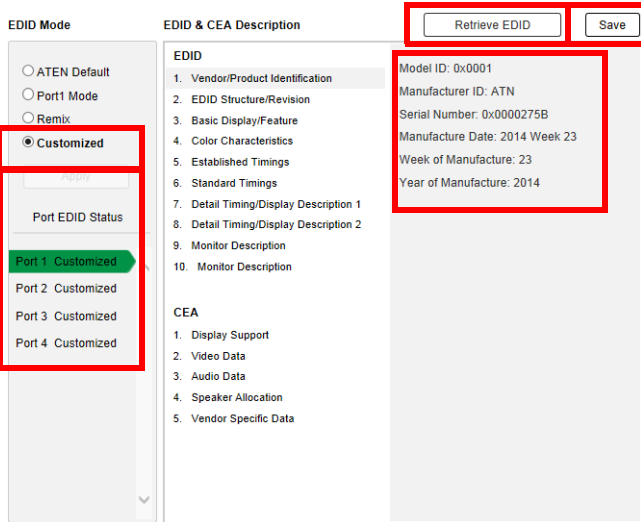

- ◆ In the left-most panel of the page, select **Customized** from the *EDID Mode* section and click **Apply**.
- ◆ **Port EDID Status:** Select which input source port you want to store the EDID configuration (01–16).
- ◆ **Retrieve EDID:** Click and a pop-up window appears to retrieve the EDID settings of a stored EDID configuration: *Customized EDID 01-16*, *Display Port* or *ATEN Default*. Select the port to retrieve:

### Caution

Select a port to retrieve.

- ◆ The right panel displays a summary of the acquired EDID settings that you can edit. Click **Save** and select the configuration for the **Current Port** or **All Ports** for the duration of the session.

### Save

Save changes to the current port or all ports?

## Customized EDID Parameters

The EDID structure is comprised of 128 bytes in total – each heading shown in the left column corresponds to a specific number of bytes.

The pages for the pre-configured EDID Modes (Port 1, Default and Remix) cannot be edited. The pages for the Customized EDID, which can be edited, are discussed in the proceeding sections:

## Established Timings

This page lists video resolutions/timings that display devices can support.

The screenshot shows the EDID configuration interface. On the left, under 'EDID Mode', 'Customized' is selected. The 'EDID & CEA Description' section is divided into 'EDID' and 'CEA'. The 'Established Timings' section is highlighted. A red box highlights the list of video resolutions, which includes options like 720x400 @ 70Hz, 640x480 @ 60Hz, 800x600 @ 60Hz, and 1024x768 @ 75Hz. The 'Save' button is visible in the top right corner.

- ◆ Select the resolution(s) you want to use for the attached monitor/display device.
- ◆ Click **Clear All** to deselect all the items.
- ◆ Click **Select All** to check all the items.
- ◆ Click **Save** to apply the changes.

## Standard Timings

This page shows eight resolutions/timings that display devices can support in addition to those listed in the Established Timings page.

**EDID Mode**

ATEN Default  
 Port1 Mode  
 Remix  
 Customized

Apply

Port EDID Status

Port 1 Customized  
 Port 2 Customized  
 Port 3 Customized  
 Port 4 Customized

**EDID & CEA Description**

Retrieve EDID Save

**EDID**

- Vendor/Product Identification
- EDID Structure/Revision
- Basic Display/Feature
- Color Characteristics
- Established Timings
- Standard Timings
- Detail Timing/Display Description 1
- Detail Timing/Display Description 2
- Monitor Description
- Monitor Description

H Active Pixel	V Active Pixel	R Refresh Rate	Aspect Ratio
H 1600	V 1200	R 60	4:3
H 1280	V 1024	R 60	5:4
H 1400	V 1050	R 60	4:3
H 1440	V 900	R 60	16:10
H 1680	V 1050	R 60	16:10
H 1920	V 1080	R 60	16:9
H 1280	V 800	R 60	16:10
H 1920	V 1200	R 60	16:10

**CEA**

- Display Support
- Video Data
- Audio Data
- Speaker Allocation
- Vendor Specific Data

- ◆ Select the *H Active Pixel* from the drop-down menu.
- ◆ Select the *Aspect Ratio* from the drop-down menu.
- ◆ Click **Save** to apply the changes.

## Detail Timing / Display Description

This screen gives more video resolution options, and provides resolution/timing details.

**EDID Mode**

ATEN Default  
 Port1 Mode  
 Remix  
 Customized

Apply

Port EDID Status

Port 1 Customized  
 Port 2 Customized  
 Port 3 Customized  
 Port 4 Customized

**EDID & CEA Description**

Retrieve EDID Save

**EDID**

- Vendor/Product Identification
- EDID Structure/Revision
- Basic Display/Feature
- Color Characteristics
- Established Timings
- Standard Timings
- Detail Timing/Display Description 1
- Detail Timing/Display Description 2
- Monitor Description
- Monitor Description

**CEA**

- Display Support
- Video Data
- Audio Data
- Speaker Allocation
- Vendor Specific Data

Resolution:

Pixel Clock(MHz): 148.50

Stereo Display  
 Interlaced: Non-interlaced  
 Stereo Mode: none  
 Sync type: Digital Separate  
 Positive Vsync Polarity: yes  
 Positive Hsync Polarity: yes

**Resolution Detail**

	Horizontal	Vertical
Image Size :	mm	mm
Active PXL :	pixel	lines
Blanking Time:	pixel	lines
Sync Offset :	pixel	lines
Sync Width:	pixel	lines
Border:	pixel	lines

In the drop down menu, choose a resolution with values that fit the attached monitor/display device and click Save.

## Monitor Description

This screen lets you specify the viewing specifications, namely horizontal and vertical scan ranges and pixel clock rate, of your monitor/display device.

**EDID Mode**

ATEN Default

Port1 Mode

Remix

**Customized**

Port EDID Status

Port 1 Customized

Port 2 Customized

Port 3 Customized

Port 4 Customized

**EDID & CEA Description**

	Minutes	Max
Horizontal Scan Range:	15	~ 102
Vertical Scan Range:	23	~ 121
Pixel Clock Rate: (MHz)	210	(10~2550)

**EDID**

1. Vendor/Product Identification
2. EDID Structure/Revision
3. Basic Display/Feature
4. Color Characteristics
5. Established Timings
6. Standard Timings
7. Detail Timing/Display Description 1
8. Detail Timing/Display Description 2
9. Monitor Description
10. Monitor Description

**CEA**

1. Display Support
2. Video Data
3. Audio Data
4. Speaker Allocation
5. Vendor Specific Data

Enter the values that correspond to your device and click **Save** to apply the changes.

## CEA Settings

CEA is an extension data of the EDID structure, which further extends the standard definitions of EDID to support advanced features of monitors/display devices.

### Display Support

This screen describes the display's basic digital components.

**EDID Mode**

ATEN Default  
 Port1 Mode  
 Remix  
 **Customized**

Port EDID Status

Port 1 Customized

Port 2 Customized

Port 3 Customized

Port 4 Customized

**EDID & CEA Description**

**EDID**

1. Vendor/Product Identification
2. EDID Structure/Revision
3. Basic Display/Feature
4. Color Characteristics
5. Established Timings
6. Standard Timings
7. Detail Timing/Display Description 1
8. Detail Timing/Display Description 2
9. Monitor Description
10. Monitor Description

**CEA**

1. Display Support
2. Video Data
3. Audio Data
4. Speaker Allocation
5. Vendor Specific Data

Revision: 0x03

Underscan: no

Basic Audio: yes

YCbCr:  YCbCr444  
 YCbCr422

Select the YCbCr mode applicable to your display and click **Save**.

## Video Data

This screen lists additional video resolution/timing displays that may be supported by other devices, other than PC monitors (for example, 1080i).

The screenshot shows the 'EDID & CEA Description' configuration page. On the left, under 'EDID Mode', 'Customized' is selected. The main area is titled 'EDID & CEA Description' and contains a list of EDID items (1-10) and CEA items (1-5). A 'Retrieve EDID' button is at the top right. Below the EDID list, a dropdown menu is set to 'Native' with the value '1920 x 1080i @ 59.94/60Hz 16:9'. Below that, a table of resolutions is displayed with checkboxes:

Resolution	Selected
640 x 480p @ 59.94/60Hz 4:3	<input checked="" type="checkbox"/>
720 x 480p @ 59.94/60Hz 4:3	<input checked="" type="checkbox"/>
720 x 480p @ 59.94/60Hz 16:9	<input checked="" type="checkbox"/>
1280 x 720p @ 59.94/60Hz 16:9	<input checked="" type="checkbox"/>
1920 x 1080i @ 59.94/60Hz 16:9	<input checked="" type="checkbox"/>
720(1440) x 480i @ 59.94/60Hz 4:3	<input type="checkbox"/>
720(1440) x 480i @ 59.94/60Hz 16:9	<input type="checkbox"/>
720(1440) x 240p @ 59.94/60Hz 4:3	<input type="checkbox"/>

At the bottom right, there is a 'Data Block Size: 10' field and a 'Clear' button.

- ◆ Select the native resolution of the attached display device.
- ◆ Select the resolutions that work with the attached monitor/display device.
- ◆ Click **Clear All** to deselect all the items.
- ◆ Click **Save** to apply the changes.

## Detail Timing / Display Description

This screen gives more video resolution options, and provides resolution/timing details (in addition to those specified in the EDID structure).

EDID Mode

ATEN Default

Port1 Mode

Remix

**Customized**

Port EDID Status

Port 1. Customized

Port 2. Customized

Port 3. Customized

Port 4. Customized

EDID & CEA Description

**EDID**

1. Vendor/Product Identification
2. EDID Structure/Revision
3. Basic Display/Feature
4. Color Characteristics
5. Established Timings
6. Standard Timings
7. Detail Timing/Display Description 1
8. Detail Timing/Display Description 2
9. Monitor Description
10. Monitor Description

**CEA**

1. Display Support
2. Video Data
3. Audio Data
4. Speaker Allocation
5. Vendor Specific Data

**Resolution:** ▼

Pixel Clock(MHz): 148.50

**Stereo Display**

Interlaced: Non-interlaced

Stereo Mode: none

Sync type: Digital Separate

Positive Vsync Polarity: yes

Positive Hsync Polarity: yes

**Resolution Detail**

	Horizontal	Vertical
Image Size :	mm	mm
Active PXL :	pixel	lines
Blanking Time:	pixel	lines
Sync Offset:	pixel	lines
Sync Width:	pixel	lines
Border:	pixel	lines

In the **Resolution** drop down menu, choose a resolution with values that fit the attached monitor/display device and click **Save**.

## Maintenance

The *Maintenance* page lets users upgrade the VM3404H / VM3909H's firmware and back up or restore system settings. This is an Administrator only function.

### Firmware upgrade

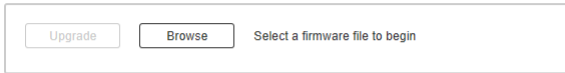

Upgrade    Browse    Select a firmware file to begin

### Backup / Restore

\*User accounts cannot be backed up or restored.

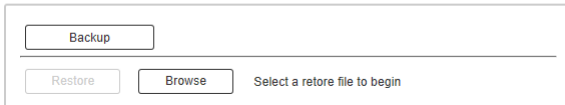

Backup

Restore    Browse    Select a restore file to begin

To upgrade the VM3404H / VM3909H's firmware, do the following:

1. Use the **Browse** button to locate the firmware upgrade file. Make sure you have the correct file saved on your PC.
2. Click **Upgrade** to begin the upgrade procedure.

---

**Note:** After updating the firmware, it's recommended that you clear your web browser's cache and then close and reopen the web browser. This will ensure the GUI refreshes and functions properly.

---

To back up the VM3404H / VM3909H's system settings, do the following:

1. Click **Backup**. A configuration file will then begin downloading.

To restore the VM3404H / VM3909H's system settings, do the following:

1. Use the **Browse** button to locate the configuration file. Make sure you have the correct file saved on your PC.
2. Click **Restore** to begin the restoration procedure.

---

**Note:** User accounts cannot be backed up or restored.

---

## IR Channel

This page allows users to view the IR channel path, and have the ability to configure the IR Channel signal path. Either one to all, or to individual ports.

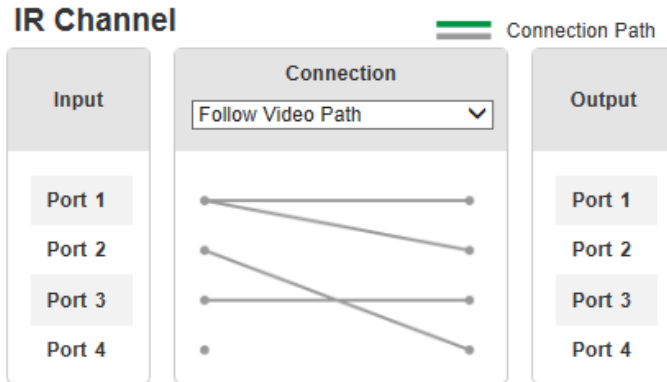

- ◆ **Connection:** Sets the connection path for the IR signal.
  - ◆ Use the drop-down menu to select *Broadcast (1-All)* to broadcast the signal from one port to all ports.
  - ◆ Use the drop-down menu to follow video path.
- ◆ **Individual Paths:** Set the connection for the IR signal Individual Paths.
  - ◆ Click the preferred input port, and then the output port to set the individual path.
  - ◆ When both ports are selected, the Individual Path will appear on the display.

Click **Save** to save the settings. Click **Cancel** to revert to the default settings.

## HDCP

The HDCP page lets users view and set HDCP key settings for digital copy protection and to ensure Seamless Switching between different devices. This is an Administrator and Advanced User only function.

**HDCP Configuration**

**Input**

Port Apply to All ▼

Port 1 All Ports HDCP 1.4 ▼

Port 2 All Ports HDCP 1.4 ▼

Port 3 All Ports HDCP 1.4 ▼

Port 4 All Ports HDCP 1.4 ▼

**Connection**

— Connection Path

**Output**

Port Apply to All ▼

Port 1  Fix HDCP

Port 2  Fix HDCP

Port 3  Fix HDCP

Port 4  Fix HDCP

### Input

Here users can select whether port content is HDCP 1.4 or non-HDCP enabled, either individually or by applying one setting to all ports.

**HDCP Configuration**

**Input**

Port Apply to All ▼

Port 1 HDCP 1.4 Content ▼

Port 2 HDCP 1.4 Content ▼

Port 3 HDCP 1.4 Content ▼

Port 4 HDCP 2.2 Content ▼

**Connection**

— Connection Path

**Output**

Port Apply to All ▼

Port 1  Fix HDCP(Non-HDCP)

Port 2  Fix HDCP(Non-HDCP)

Port 3  Fix HDCP(Non-HDCP)

Port 4  Fix HDCP(Non-HDCP)

### Connection

Here users can find a visual display of connection paths between inputs and outputs. When selecting an input, its path is displayed in green.

### Output

Here users can define whether or not HDCP settings are fixed, either by individual port or by applying one setting to all ports. By prearranging and fixing keys, this setting ensures that Seamless Switching is possible even when switching between HDCP and non-HDCP enabled devices.

## OSD/CEC

The OSD/CEC page lets users view and set OSD and CEC settings for all ports.

**OSD / CEC**

Port	OSD	CEC
	<input type="text" value="Apply to All"/>	<input type="text" value="Apply to All"/>
Port1	<input checked="" type="checkbox"/> ON	<input type="checkbox"/> OFF
Port2	<input checked="" type="checkbox"/> ON	<input type="checkbox"/> OFF
Port3	<input checked="" type="checkbox"/> ON	<input type="checkbox"/> OFF
Port4	<input checked="" type="checkbox"/> ON	<input type="checkbox"/> OFF

\* The CEC setting is only for output boards, please make sure all devices have this capability.

- ◆ **OSD:** Sets the default OSD option for the port. When OSD is on, real-time text updates appear on the display for 10 seconds when configuration and port changes are made to its output.
  - ◆ Use the drop-down menu to apply options to all ports, or ON/OFF button to enable/disable the OSD for each port.
- ◆ **CEC:** Consumer Electronics Control (CEC) allows interconnected HDMI devices to communicate and respond to one remote control.
  - ◆ Use the drop-down menu to apply options to all ports, or On/Off button to enable/disable CEC for a port.
- ◆ Click **Save** to save the settings or **Cancel** to exit without saving the settings.

# Chapter 5

## Mobile Control

### Overview

---

The VM3404H / VM3909H supports Video Matrix Control App, a free mobile app that allows you to switch profiles, audio inputs and video inputs, and also reminds you when any new firmware is available, all through a local area network to which the target VM3404H / VM3909H is connected. This mobile application is especially useful for profile and AV source switching when you do not have access to the VM3404H / VM3909H's front panel or the web interface.

# The Video Matrix Control App

---

## Requirements



- ◆ Make sure your mobile device uses a supported version of the mobile operating system listed below before installing the app.

Mobile Operating System	Supported Version
iOS	12.0 or later
Android	8.0 or later

- ◆ The VM3404H / VM3909H needs to be connected to a local area network via the Ethernet port.

## Installation and Connections

To install the Video Matrix Control App on a mobile device, do the following:

1. From the mobile device, tap the **App Store**  or **Google Play**  icon.
2. In the search box, type “Video Matrix Control App”.
3. Tap Video Matrix Control App and then download and install the app.
4. Tap the app icon.
5. Follow the on-screen instructions to connect to the target VM3404H / VM3909H device by scanning the network, selecting from connection history, or specifying the device IP address and password.



---

### Note:

- ◆ The Video Matrix Control App is designed to control one VM3404H / VM3909H device at a time.
  - ◆ If you cannot find the VM3404H / VM3909H device, make sure that the VM3404H / VM3909H is connected to LAN and that the app is connected to the same LAN and then try again.
-

## The Control Interface

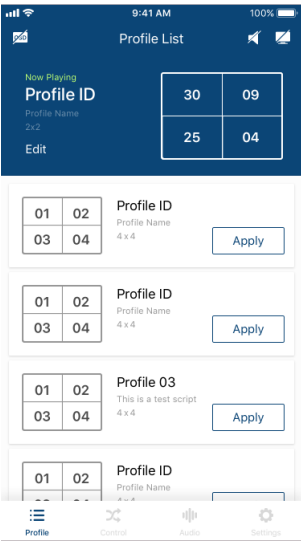
The functions in the Video Matrix Control App are categorized into four tabs – **Profile**, **Control**, **Audio**, and **Settings**. See the table below for an overview of each tab.

Control Interface	Description
	<p>In the <b>Profile</b> tab, you can switch profiles for display or change the video input for the profile that is playing.</p> <p><b>Note:</b></p> <ul style="list-style-type: none"> <li>◆ The Video Matrix Control App can not be used to create profiles. Before using the app, make sure to create the profiles you need via the web interface. For details, see <i>Adding/Playing a Profile</i>, page 41.</li> <li>◆ Any configuration change made to a profile via Video Matrix Control App is only effective while the profile is being played and will not be saved to the VM3404H / VM3909H unit.</li> <li>◆ Previews of input assignment, as indicated by input numbers in the control interface on the left, are not supported for VM0404HB, VM0808HA, and VM0808HB.</li> </ul>
	<p>In the <b>Control</b> tab, you can instantly switch video inputs for each of the output.</p>

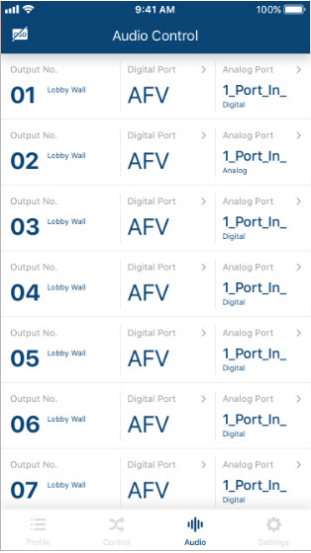
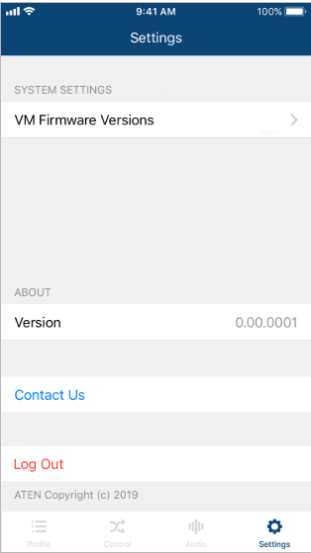
Control Interface	Description
 <p>The screenshot shows the 'Audio Control' screen with a list of 7 outputs. Each output row includes an 'Output No.', a 'Lobby Wall' label, a 'Digital Port' dropdown set to 'AFV', and an 'Analog Port' dropdown. For outputs 01-06, the analog port is '1_Port_In_' (Digital). For output 07, it is '1_Port_In_' (Analog). The bottom navigation bar shows 'Profile', 'Control', 'Audio' (selected), and 'Settings'.</p>	<p>In the <b>Audio</b> tab, you can specify the audio input for the digital and analog outputs of the VM3404H / VM3909H.</p> <p><b>Note:</b> The fields available in this tab may vary for the connected device.</p>
 <p>The screenshot shows the 'Settings' screen. Under 'SYSTEM SETTINGS', there is a 'VM Firmware Versions' link. Under 'ABOUT', the 'Version' is '0.00.0001'. There are also links for 'Contact Us' and 'Log Out'. The bottom navigation bar shows 'Profile', 'Control', 'Audio', and 'Settings' (selected).</p>	<p>In the <b>Settings</b> tab, you can look up notification for system firmware upgrades, the current app version, and technical support contact, or log out of the app.</p>

# Chapter 6

## CLI Commands

### Overview

---

The VM3404H / VM3909H can be configured and controlled via RS-232 or Telnet commands when connected to a host computer or other device, such as a control system. This chapter provides information on how to connect to the VM3404H / VM3909H via RS-232/Telnet and command syntax.

### Connecting to the Matrix Switch via Telnet

---

To establish a Telnet session with the VM3404H / VM3909H, do the following:

1. Connect a host computer or control system to a shared network with the VM3404H / VM3909H.
2. Open a command-line interpreter program from your computer.
3. In the command-line interpreter, type the VM3404H / VM3909H's IP address in the following way:  

```
telnet [IP address]:23
```
4. Press **Enter**. The login screen appears.
5. At the login prompt, type the login username and password for the VM3404H / VM3909H.
6. When a session is established with the VM3404H / VM3909H, you can control and configure the VM3404H / VM3909H via RS-232 commands. For more information on commands, see *Commands*, page 87

---

**Note:** If a user logs in using a username that is already in session, the newest login takes effect and the previous session will be replaced.

---

## Connecting to the Matrix Switch via RS-232

You can control and operate the VM3404H / VM3909H using a high-end controller or PC. To connect to the VM3404H / VM3909H via RS-232, do the following:

1. Connect the RS-232 serial port on the VM3404H / VM3909H to the RS-232 serial port on your computer using a 9-wire straight cable, with only pin 2 to pin 2, pin 3 to pin 3, and pin 5 to pin 5 connected.

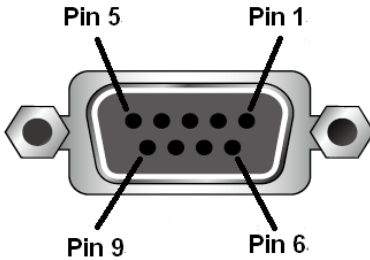

Pin	Description
1	Not connected
2	RXD
3	TXD
4	Not connected
5	GND
6	Not connected
7	Not connected
8	Not connected
9	Not connected

2. The controller's serial port should be configured as follows:

RS-232 Protocol	
Baud Rate	19200
Data Bits	8
Parity	None
Stop Bits	1
Flow Control	None

3. When a session is established with the VM3404H / VM3909H, you can control and configure the VM3404H / VM3909H via RS-232 commands. For more information on commands, see *Commands*, page 87.

## Verification

---

After entering a command, a verification message appears at the end of the command line as follows:

- ◆ **Command OK** - indicates that the command is correct and successfully performed by the switch
- ◆ **Command incorrect** - indicates that the command has the wrong format and/or values.

## Commands

---

After connecting to the VM3404H / VM3909H via Telnet or RS-232, you can operate the system using the following commands.

### Switch Port Command

The Switch Port command allows you to switch ports on the VM3404H / VM3909H.

The formula for the Switch command is as follows:

**Command + Input + Number + Output + Number + Control + [Enter]**

1. For example, to switch input port 02 to output port 05, type:  
**sw i02 o05 [Enter]**
2. To switch output port 04 to the next port, type:  
**sw o04 + [Enter]**
3. To turn off video output on port 03, type:  
**sw o03 off [Enter]**

The following tables show the possible values for the **Switch Port** command:

Command	Description
sw	Switch command

Input Command	Description
i	Input command

Port number	Description
xx	01-09 port

Output Command	Description
o	Output command

Port number	Description
yy	01-09 port
*	All output ports

Control	Description
on	Turn on the display
off	Turn off the display
+	Next Port
-	Previous Port

- Note:**
1. By default, input port 01 is tied to output port 01; input port 02 is tied to output port 02; and so on until port 09 (i.e., o01 i01, o02 i02).
  2. Each command string can be separated with a space.
  3. The **Port Number** can be skipped, and the default value will be used.

The following table lists the available Switch Port commands:

Command	Input Command	Input Port	Output Command	Output Port	Control	Enter	Description
sw	i	xx	o	yy *		[Enter]	Switch Input Port xx to Output Port yy (xx:01~09; yy:01~09, *)
sw			o	yy *	on off	[Enter]	Turn on Output Port yy Turn off Output Port yy (yy:01~09, *)
sw			o	yy *	+ -	[Enter]	Switch Output port yy to next Output port. Switch Output port yy to previous Output port. (yy:01~09, *)

## EDID Mode Command

Extended Display Identification Data (EDID) is a data that contains a display's basic information and is used to communicate with the video source.

The formula for the EDID command is as follows:

**Command + Control + [Enter]**

1. For example, to use the Port1 EDID mode, type:

**edid port1 [enter]**

The following tables show the possible values for the **EDID** command:

Command	Description
edid	EDID Mode command

Control	Description
port1	Implement the EDID of the connected display to Port 1, and pass it to the video source.
remix	Implement the EDID of each connected display according to its connection when the VM3404H / VM3909H is first powered on, or immediately after selecting the Remix option.
default	Implements ATEN's default EDID. (default)
custom	Implements the customized mode as set in the EDID system settings. (See <i>Customized Mode</i> , page 70)

**Note:** Each command string can be separated with a space.

The following table lists the available EDID commands:

Command	Control	Enter	Description
edid	port1	[Enter]	The EDID from Port 1 is passed to the video source.
edid	remix	[Enter]	The VM3404H / VM3909H implements the EDID of each connected display according to its connection when the VM3404H / VM3909H is first powered on, or immediately after selecting the Remix option.
edid	default	[Enter]	ATEN's default EDID is passed to the video source.
edit	custom	[Enter]	Implements the customized mode.

## **CEC Command**

Consumer Electronics Control (CEC) allows interconnected HDMI devices to communicate and respond to the same remote control.

The formula for the CEC command is as follows:

**Command + Output + Number + Control + [Enter]**

1. For example, to enable the CEC function on output port 1, type:  
**cec o01 on [enter]**

The following tables show the possible values for the CEC command:

<b>Command</b>	<b>Description</b>
cec	CEC command

<b>Output Command</b>	<b>Description</b>
o	Output command

<b>Port number</b>	<b>Description</b>
yy	01-09 port (default is 01)
*	All output ports

<b>Control</b>	<b>Description</b>
off	Disable CEC (default)
on	Enable CEC

---

**Note:** Each command string can be separated with a space.

---

The following table lists the available CEC commands:

<b>Command</b>	<b>Output</b>	<b>Output Port</b>	<b>Control</b>	<b>Enter</b>	<b>Description</b>
cec	o	yy *	off	[Enter]	CEC off for output port yy (default) (yy:01~09, *)
cec	o	yy *	on	[Enter]	CEC on for output port yy (yy:01~09, *)

## Scaling Command

The Scaling command allows you to set a resolution for scaling the display connected to an output port.

The formula for the Scaling command is as follows:

**Command + Output + Number + Address + Number + Horizontal resolution + Number + Vertical Resolution + Number + [Enter]**

1. For example, to turn scaling off for output port 02, type:  
**scaling o02 off [Enter]**
2. To set the scaling for output port 04 to 1920x1080@60Hz, type:  
**scaling o04 1080p [Enter]**
3. To set the scaling for all output ports to the connected display's native resolution, type:  
**scaling o\* native [Enter]**

The following tables show the possible values for the **Scaling** command:

Command	Description
scaling	Scaling command

Output Command	Description
o	Output command

Port Number	Description
yy	01-09 port
*	All output ports

Control	Description
off	Turn off the scaling function (by pass mode)
native	Map display's native resolution for scaling (default)
1080p	Scale to 1920x1080@60Hz
720p	Scale to 1280x720@60Hz
1920	Scale to 1920x1200@60Hz
1800	Scale to 1800x1200@60Hz
1400	Scale to 1400x1050@60Hz
1280	Scale to 1280x1024@60Hz
1024	Scale to 1024x768@60Hz

Control	Description
hor	Horizontal of scaling resolution
hhhh	Horizontal resolution
ver	Vertical of scaling resolution
vvvv	Vertical resolution
freq	Frequency of scaling resolution
fff	Scaling resolution frequency

- Note:** 1. Each command string can be separated with a space.
2. The **Port Number** command string can be skipped, and the default value will be used.

The following table lists the available Scaling commands:

Command	Output	Port Number	Control	Enter	Description
scaling	o	yy *	off	[Enter]	Turn off scaling for port yy (by pass mode) yy: 01 ~ 09 or *
scaling	o	yy *	native	[Enter]	Enable display's native resolution for scaling on output port yy (default) yy: 01 ~ 09 or *
scaling	o	yy *	1080p	[Enter]	Scale output port yy to 1920x1080@60Hz yy: 01 ~ 09 or *
scaling	o	yy *	720p	[Enter]	Scale output port yy to 1280x720@60Hz yy: 01 ~ 09 or *
scaling	o	yy *	1920	[Enter]	Scale output port yy to 1920x1200@60Hz yy: 01 ~ 09 or *
scaling	o	yy *	1800	[Enter]	Scale output port yy to 1800x1200@60Hz yy: 01 ~ 09 or *
scaling	o	yy *	1400	[Enter]	Scale output port yy to 1400x1050@60Hz yy: 01 ~ 09 or *

Command	Output	Port Number	Control	Enter	Description
scaling	o	yy *	1280	[Enter]	Scale output port yy to 1280x1024@60Hz yy: 01 ~ 09 or *
scaling	o	yy *	1024	[Enter]	Scale output port yy to 1024x768@60Hz yy: 01 ~ 09 or *
scaling	o	yy *	hor 1920 ver 1080 freq 60	[Enter]	Scale output port yy to 1920x1080@60Hz yy: 01 ~ 09 or *
scaling	o	yy *	hor 4096 ver 2048 freq 30	[Enter]	Scale output port yy to 4096x2048@30Hz yy: 01 ~ 09 or *

## Echo Command

The Echo function updates the RS232 controller when operations are made via the front panel pushbuttons, web browser, or telnet. The changes echo back to the RS232 controller to keep the settings in sync with the device.

The formula for the Echo command is as follows:

**Command + Control + [Enter]**

1. For example, to enable the echo feature, type:

**echo on [Enter]**

The following tables show the possible values for the **Echo** command:

Command	Description
echo	Echo command

Control	Description
on	Turns Echo function on
off	Turns Echo function off (default)

---

**Note:** Each command string can be separated with a space.

---

The following table lists the available Echo commands:

Command	Control	Enter	Description
echo	on	[Enter]	Turn on Echo function
echo	off	[Enter]	Turn off Echo function

## **Read Command**

The Read command allows you to view the current configuration, firmware and other information about the device.

The formula for the Read command is as follows:

**Command + [Enter]**

1. To view information about the device, type:

**read [Enter]**

The following table shows the possible values for the **Read** command:

---

<b>Command</b>	<b>Description</b>
read	Read command

---

**Note:** Each command string can be separated with a space.

---

The following table lists the available Read commands:

<b>Command</b>	<b>Enter</b>	<b>Description</b>
read	[Enter]	View information about the device

---

## **Reset Command**

The Reset command allows you to reset the VM3404H / VM3909H to the default factory settings.

The formula for the Reset command is as follows:

**Command + [Enter]**

The following tables show the possible values for the **Reset** command:

---

<b>Command</b>	<b>Description</b>
reset	Reset command

---

**Note:** Each command string can be separated with a space.

---

The following table lists the available Reset commands:

<b>Command</b>	<b>Enter</b>	<b>Description</b>
reset	[Enter]	Resets the device settings

## Baud Rate Command

The Baud Rate command allows you to set the RS-232 data rate for the VM3404H / VM3909H to use. Options are 9600, 19200 (default) 38400 and 115200.

The formula for the Baud Rate command is as follows:

**Command + Control + [Enter]**

- For example, to set 38400 as the baud rate, type:

**baud 38400 [Enter]**

The following tables show the possible values for the **Baud Rate** command:

Command	Description
baud	Sets the RS-232 baud rate

Control	Description
9600	Use 9600 baud rate
19200	Use 19200 baud rate (default)
38400	Use 38400 baud rate
115200	Use 115200 baud rate

**Note:** Each command string can be separated with a space.

The following table lists the available Baud Rate commands:

Command	Control	Enter	Description
baud	9600 / 19200 / 38400 / 115200	[Enter]	Sets the RS-232 baud rate

## **Save/Load Profile Command**

The Save/Load Profile command allows you to save and load connection profiles. Saving profiles will save the connections currently in use.

The formula for the Save/Load Profile command is as follows:

**Command + Profile + Number + Control + [Enter]**

1. For example, to save the current connection configuration to profile 02, type:

**profile f 02 save [Enter]**

The following tables show the possible values for the **Save/Load Profile** commands:

Command	Description
profile	Save / Load profile
Profile	Description
f	Profile command
Profile Number	Description
yy	VM3404H: 01-09 (default is 01)
	VM3909H: 01-18 (default is 01)
Control	Description
save	Save the connection configuration
load	Load a saved profile

---

**Note:** Each command string can be separated with a space.

---

The following table lists the available Save/Load Profile commands:

Command	Profile	Profile Number	Control	Enter	Description
profile	f	yy *	save	[Enter]	Save the connections as profile yy. VM3404H: (yy:01~08, *)
					VM3909H: (yy:01~18, *)
profile	f	yy *	load	[Enter]	Load profile yy. VM3404H: (yy:01~08, *)
					VM3909H: (yy:01~18, *)

## OSD Command

To enable or disable the On-Screen Display (OSD) using the following command:

**Command + Output Command + Port Number + Control + [Enter]**

1. For example, to enable the OSD, type:

**osd on [enter]**

The following tables show the possible values for the **OSD** command:

Command	Description
osd	Enable / Disable the OSD
Output Command	Description
o	Output command
Port Number	Description
yy	01-09 port
*	All output ports
Control	Description
on	OSD is enabled (default)
off	OSD is disabled

**Note:** Each command string can be separated with a space.

The following table lists the available OSD commands:

Command	Output Command	Output Port	Control	Enter	Description
osd	o	yy *	on	[Enter]	OSD on
osd	o	yy *	off	[Enter]	OSD off

This Page Intentionally Left Blank

## Safety Instructions

---

### General

- ◆ Read all of these instructions. Save them for future reference.
- ◆ Follow all warnings and instructions marked on the device.
- ◆ This product is for indoor use only.
- ◆ Do not place the device on any unstable surface (cart, stand, table, etc.). If the device falls, serious damage will result.
- ◆ Do not use the device near water.
- ◆ Do not place the device near, or over, radiators or heat registers.
- ◆ The device cabinet is provided with slots and openings to allow for adequate ventilation. To ensure reliable operation, and to protect against overheating, these openings must never be blocked or covered.
- ◆ The device should never be placed on a soft surface (bed, sofa, rug, etc.) as this will block its ventilation openings. Likewise, the device should not be placed in a built in enclosure unless adequate ventilation has been provided.
- ◆ Never spill liquid of any kind on the device.
- ◆ Unplug the device from the wall outlet before cleaning. Do not use liquid or aerosol cleaners. Use a damp cloth for cleaning.
- ◆ The device should be operated from the type of power source indicated on the marking label. If you are not sure of the type of power available, consult your dealer or local power company.
- ◆ The device is designed for IT power distribution systems with 230V phase-to-phase voltage.
- ◆ To prevent damage to your installation it is important that all devices are properly grounded.
- ◆ The device is equipped with a 3-wire grounding type plug. This is a safety feature. If you are unable to insert the plug into the outlet, contact your electrician to replace your obsolete outlet. Do not attempt to defeat the purpose of the grounding-type plug. Always follow your local/national wiring codes.
- ◆ Do not allow anything to rest on the power cord or cables. Route the power cord and cables so that they cannot be stepped on or tripped over.

- ◆ If an extension cord is used with this device make sure that the total of the ampere ratings of all products used on this cord does not exceed the extension cord ampere rating. Make sure that the total of all products plugged into the wall outlet does not exceed 15 amperes.
- ◆ To help protect your system from sudden, transient increases and decreases in electrical power, use a surge suppressor, line conditioner, or un-interruptible power supply (UPS).
- ◆ Position system cables and power cables carefully; Be sure that nothing rests on any cables.
- ◆ Never push objects of any kind into or through cabinet slots. They may touch dangerous voltage points or short out parts resulting in a risk of fire or electrical shock.
- ◆ Do not attempt to service the device yourself. Refer all servicing to qualified service personnel.
- ◆ If the following conditions occur, unplug the device from the wall outlet and bring it to qualified service personnel for repair.
  - ◆ The power cord or plug has become damaged or frayed.
  - ◆ Liquid has been spilled into the device.
  - ◆ The device has been exposed to rain or water.
  - ◆ The device has been dropped, or the cabinet has been damaged.
  - ◆ The device exhibits a distinct change in performance, indicating a need for service.
  - ◆ The device does not operate normally when the operating instructions are followed.
- ◆ Only adjust those controls that are covered in the operating instructions. Improper adjustment of other controls may result in damage that will require extensive work by a qualified technician to repair.
- ◆ Safety warning: Avoid circuit overloads. Before connecting equipment to a circuit, know the power supply's limit and never exceed it. Always review the electrical specifications of a circuit to ensure that you are not creating a dangerous condition or that one doesn't already exist. Circuit overloads can cause a fire and destroy equipment.

## **Rack Mounting**

- ◆ Before working on the rack, make sure that the stabilizers are secured to the rack, extended to the floor, and that the full weight of the rack rests on the floor. Install front and side stabilizers on a single rack or front stabilizers for joined multiple racks before working on the rack.
- ◆ Always load the rack from the bottom up, and load the heaviest item in the rack first.
- ◆ Make sure that the rack is level and stable before extending a device from the rack.
- ◆ Do not overload the AC supply branch circuit that provides power to the rack. The total rack load should not exceed 80 percent of the branch circuit rating.
- ◆ Make sure that all equipment used on the rack – including power strips and other electrical connectors – is properly grounded.
- ◆ Ensure that proper airflow is provided to devices in the rack.
- ◆ Ensure that the operating ambient temperature of the rack environment does not exceed the maximum ambient temperature specified for the equipment by the manufacturer.
- ◆ Do not step on or stand on any device when servicing other devices in a rack.

## Technical Support

---

### International

- ◆ For online technical support – including troubleshooting, documentation, and software updates: **<http://eservice.aten.com>**
- ◆ For telephone support, see *Telephone Support*, page vii:

### North America

Email Support		<a href="mailto:support@aten-usa.com">support@aten-usa.com</a>
Online Technical Support	Troubleshooting Documentation Software Updates	<a href="http://www.aten-usa.com/support">http://www.aten-usa.com/support</a>
Telephone Support		1-988-999-ATEN ext 4988

When you contact us, please have the following information ready beforehand:

- ◆ Product model number, serial number, and date of purchase.
- ◆ Your computer configuration, including operating system, revision level, expansion cards, and software.
- ◆ Any error messages displayed at the time the error occurred.
- ◆ The sequence of operations that led up to the error.
- ◆ Any other information you feel may be of help.

# Specifications

Function		VM3404H	VM3909H
Video Input	Interface	4 x HDMI Type A Female (Black)	9 x HDMI Type A Female (Black)
	Impedance	100 Ω	
	Max. Distance	1.8 m	
Video Output	Interface	4 x HDMI Type A Female (Black) 4 x RJ-45 Female	9 x HDMI Type A Female (Black) 9 x RJ-45 Female
	Impedance	100 Ω	
	Max. Distance	HDMI: 15 m HDBaseT (Class B): 4K@35m (Cat 5e/6) / 40m (Cat 6a); 1080p@60m (Cat 5e/6) / 70m (Cat 6a)	
Video	Max. Data Rate	10.2 Gbps (3.4 Gbps Per Lane)	
	Max. Pixel Clock	340 MHz	
	Compliance	HDMI (3D, Deep Color, 4K); HDCP 1.4 Compatible; Consumer Electronic Control (CEC); HDBaseT Compatible	
	Max. Resolution	Up to 4096 x 2160 / 3840 x 2160 @ 60Hz (4:2:0); 4096 x 2160 / 3840 x 2160 @ 30Hz (4:4:4)	
	Max. Distance	Up to 70 m*	
Control	Ethernet	1 x RJ-45 Female	
	RS-232	Connector: 1 x DB9 Female (Black) Baud Rate: 19200, Data Bits: 8, Stop Bits:1, Parity: No, Flow Control: No	
	IR Channel	4 x Mini Stereo Jack Female (Black); 30~60 kHz full range transmission	9 x Mini Stereo Jack Female (Black); 30~60 kHz full range transmission
EDID Settings		EDID Mode: Default / Port1 / Remix / Customized	
Power	Connector	1 x 3-Prong AC Socket	
	I/P Rating	100-240VAC; 50-60Hz; 1.0A	
	Consumption	110 VAC, 42.90W; 220 VAC,41.58W (w/o PoE)	110 VAC, 77.44 W; 220 VAC, 75.24 W (w/o PoE)
Environmental	Operating Temperature	0–50°C	
	Storage Temperature	-20–60°C	
	Humidity	0–80% RH, Non-condensing	

Function		VM3404H	VM3909H
Physical Properties	Housing	Metal	
	Weight	5.62 kg	7.33 kg
	Dimensions (L x W x H)	43.24 x 38.23 x 4.40 cm	43.24 x 38.23 x 8.80 cm
Carton Lot		1 pc	

**Note:** A Cat 6a RJ-45 cable is required in order to extend a signal to 70m.

## Compatible Receivers

Receiver	Max. Distance	IR	4K	Seamless Switch™	Video Wall	POH	Dual View
VE801R	70m*		Yes				
VE802R	70m*	Yes	Yes			Yes	
VE805R (with Scaler)	70m*	Yes		Yes	Yes		
VE816R (with Scaler)	70m*	Yes	Yes	Yes	Yes		
VE814AR	70m	Yes	Yes				Yes
VE601R (DVI)	70m*						
VE901R	70m*		Yes				

\* Cat 6a Ethernet cable is required to extend the distance up to 70 meters.

\*\* The VE816R is only supported on VM3404H / VM3909H using firmware version 2.2.213 or later.

## Telnet Operation

---

To connect to VM3404H / VM3909H via Telnet, follow the steps in *Connecting to the Matrix Switch via Telnet*, page 85.

### **Configuration Menu**

Once a Telnet connection to the VM3404H / VM3909H is established, the device's text-based Configuration Menu comes up, with the following items:

#### **1. H – Call up the command list for help**

Command list:

IP – Set IP address

LO – Load connections from profile *nn*

PW – Change password

RI – Read what input is connected to *nn* output

RO – Read what output is connected to *nn* input

SB – Set the serial port baud rate

SS – Switch input to specified port

SV – Save the current connections into profile *nn*

TI – Set timeout

VR – Software version information

Ctrl-Q – Quit

#### **2. IP – Set IP address**

IP

Old IP address: 192.168.0.60

New IP address:

#### **3. LO – Load connections from profile**

LO 01

Load profile 01 OK.

**4. PW – Change password**

PW

Old password: \*\*\*\*\*

New password:

**5. RI – Read what input is connected to *nn* output**

RI 01

Input port 02 04 08 is connected to output port 01

**6. RO – Read what output is connected to *nn* input**

RO 01

Output port 02 is connected to input port 01

**7. SB – Set serial port baud rate**

SB 96

Serial port baud rate is set to 9600

**8. SS – Switch input to specified output**

SS 01, 03

Switch input 01 to output 03 (00: Local Port)

**9. SV – Save the current connections into a profile**

SV 01

Save the current connections into profile 01

**10. TI – Set timeout**

TI 30

Set 30 minute timeout

**11. VR – Software version information**

VR

Software version 1.0.

## Limited Warranty

---

ATEN warrants its hardware in the country of purchase against flaws in materials and workmanship for a Warranty Period of two [2] years (warranty period may vary in certain regions/countries) commencing on the date of original purchase. This warranty period includes the [LCD panel of ATEN LCD KVM switches](#). Select products are warranted for an additional year (see [A+ Warranty](#) for further details). Cables and accessories are not covered by the Standard Warranty.

### What is covered by the Limited Hardware Warranty

ATEN will provide a repair service, without charge, during the Warranty Period. If a product is defective, ATEN will, at its discretion, have the option to (1) repair said product with new or repaired components, or (2) replace the entire product with an identical product or with a similar product which fulfills the same function as the defective product. Replaced products assume the warranty of the original product for the remaining period or a period of 90 days, whichever is longer. When the products or components are replaced, the replacing articles shall become customer property and the replaced articles shall become the property of ATEN.

To learn more about our warranty policies, please visit our website:  
<http://www.aten.com/global/en/legal/policies/warranty-policy/>

© Copyright 2021 ATEN® International Co., Ltd.  
Released: 2021-05-11

ATEN and the ATEN logo are registered trademarks of ATEN International Co., Ltd. All rights reserved. All other brand names and trademarks are the registered property of their respective owners.