

CX-50 Gen2

ClickShare



User guide

Barco NV
Beneluxpark 21, 8500 Kortrijk, Belgium
www.barco.com

Manufacturer: Barco NV
President Kennedypark 35, 8500 Kortrijk, Belgium

Copyright ©

All rights reserved. No part of this document may be copied, reproduced or translated. It shall not otherwise be recorded, transmitted or stored in a retrieval system without the prior written consent of Barco.

Trademarks

Brand and product names mentioned in this manual may be trademarks, registered trademarks or copyrights of their respective holders. All brand and product names mentioned in this manual serve as comments or examples and are not to be understood as advertising for the products or their manufacturers.

Changes

Barco provides this manual 'as is' without warranty of any kind, either expressed or implied, including but not limited to the implied warranties or merchantability and fitness for a particular purpose. Barco may make improvements and/or changes to the product(s) and/or the program(s) described in this publication at any time without notice.

This publication could contain technical inaccuracies or typographical errors. Changes are periodically made to the information in this publication; these changes are incorporated in new editions of this publication.

The latest edition of Barco manuals can be downloaded from the Barco website <https://www.barco.com>.

Patent protection

This product is covered by patents and/or pending patent applications. For more info: <https://www.barco.com/en/about-barco/legal/patents>.

Product Security Incident Response

As a global technology leader, Barco is committed to deliver secure solutions and services to our customers, while protecting Barco's intellectual property. When product security concerns are received, the product security incident response process will be triggered immediately. To address specific security concerns or to report security issues with Barco products, please inform us via contact details mentioned on <https://www.barco.com/psirt>. To protect our customers, Barco does not publicly disclose or confirm security vulnerabilities until Barco has conducted an analysis of the product and issued fixes and/or mitigations.

Disclaimer on screenshot images used in this manual

The screenshot images used in this manual are example illustrations and should be treated as such. While the name of the product displayed in the images may be different from the product model currently used, the menu lay-out and functionality is identical.

Software License Agreement

Carefully read the following terms and conditions before using this software. Any use of this software indicates the acceptance of this license agreement and warranty.

Terms and Conditions:

1. No redistribution of the software is allowed.
2. Reverse-Engineering. This software product may not be reverse engineered, decompiled, disassembled or altered.

Disclaimer of Warranty:

This software and the accompanying files are sold "as is" and without warranties as to performance or merchantability or any other warranties whether expressed or implied. In no event shall Barco be liable for damage of any kind, loss of data, loss of profits, business interruption or other pecuniary loss arising directly or indirectly. Any liability of the seller will be exclusively limited to replacement of the product or refund of purchase price.

Table of contents

1	Introduction	7
1.1	The Base Unit	8
1.2	The ClickShare Button	9
2	Preparing the hardware	11
2.1	Waking the Base Unit	12
2.2	Pairing the Button(s)	12
3	ClickShare software	15
3.1	Installing the desktop app	16
3.2	Installing the mobile app	16
3.3	App updates	18
4	Using ClickShare	19
4.1	Connect to a meeting room	20
4.1.1	Methods of connecting	20
4.1.2	Connecting with a Button	20
4.1.3	ClickShare app	20
4.1.4	Button & desktop app	22
4.1.5	PresentSense	22
4.1.6	Wired roomdock	25
4.2	Configuring the peripherals	25
4.2.1	Audio configuration	25
4.3	Screen sharing	26
4.3.1	Methods of sharing	26
4.3.2	Button sharing	26
4.3.3	Desktop app sharing	26
4.3.4	Mobile app sharing	29
4.3.5	Third party sharing	31
4.4	Conferencing	31
4.4.1	Methods of conferencing	31
4.4.2	Standard conferencing	31
4.4.3	One click join	32
4.4.4	Conference view	33
4.5	Additional ClickShare features	34
4.5.1	Blackboarding & annotations	34
4.5.2	Touch back	36

4.5.3	PowerPoint presenter mode	37
4.5.4	Calendar integration	37
5	Leaving the meeting room	41
5.1	Closing the connection	42
5.2	Hardware cleanup	42
6	Troubleshooting	43
6.1	Basic troubleshooting	44
A	Specifications	49
A.1	Base Unit specifications	50
A.2	Button specifications	51
B	Regulatory	53
B.1	Product and contact references	54
B.2	International safety standards	54
B.3	Product compliance EU	54
B.4	Product compliance UK	56
B.5	Product compliance Ukraine	57
B.6	Product compliance Russia	58
B.7	Product compliance Turkey	58
B.8	Product compliance US	58
B.9	Product compliance Canada	59
B.10	Product compliance Brazil	61
B.11	Product compliance Mexico	61
B.12	Product compliance Korea	62
B.13	Product compliance Taiwan	63
B.14	Product compliance China	64
B.15	Product compliance Thailand	65
B.16	Product compliance India	65
B.17	Product privacy statement	65
B.18	Trademark notice	66
C	License information	67
C.1	End user license	68
C.2	ClickShare product end user license	72
C.3	Open source software	73
	Index	75

Introduction

1

1.1	The Base Unit	8
1.2	The ClickShare Button	9

About this document

This user guide provides an overview of a ClickShare system with the CX-50 Gen2 at its core. For installation instructions of the ClickShare system, see the [CX-50 Gen2](#) installation manual.

About introduction

Details about the ClickShare hardware will be explored in this chapter. Common terminology required to follow the rest of the manual is also explained.

Clarification of the term “Base Unit” used in this document

When referring in this document to the term “Base Unit” means that the content is applicable for following Barco products:

- CX-50 Gen2

Clarification of the term “Button” used in this document

When referring in this document to the term “Button” means that the content is applicable for following Barco products:

- 4th gen Button

Model certification names

- **Base Unit:** C5011S
- **Button:** R9861600D01C, CSBTN004

1.1 The Base Unit

About the Base Unit

The CX-50 Gen2 is the Base Unit of a ClickShare installation. It is responsible for enabling the ClickShare functionalities and managing or controlling the connected devices.



The CX-50 Gen2 is only compatible with 4th gen Buttons. For more information about the Button, see “The ClickShare Button”, page 9.

Countries and peripherals

The Base Unit and peripherals are regionalized. An up to date list of the certified countries and applicable peripherals can be found on the product support page. For more information, see <https://www.barco.com/en/support>.



The Base Unit is region locked and cannot be used outside its original region.

Components

Front view:

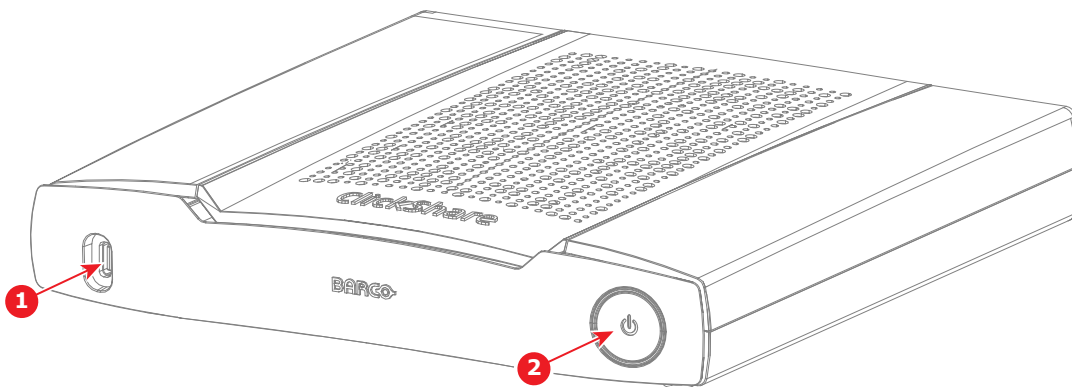

Image 1–1

- 1 Front USB-C™ port
- 2 Power button

Back view:

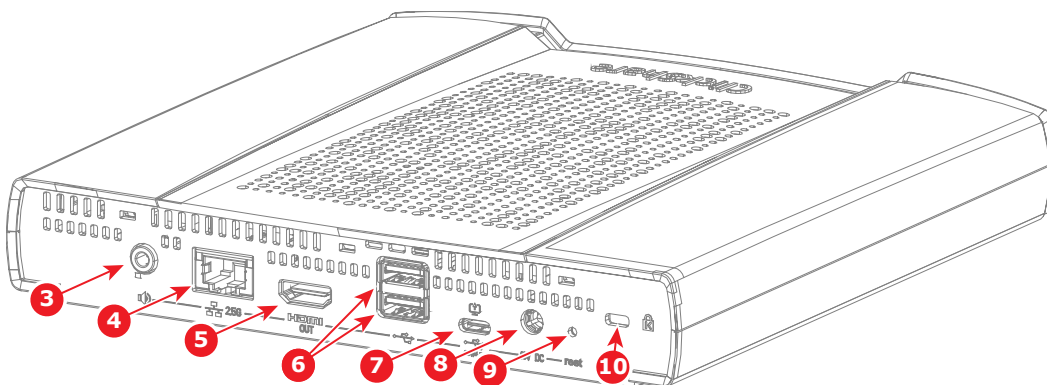

Image 1–2

- | | |
|---------------------|----------------------|
| 3 Audio output port | 7 Back USB-C™ port |
| 4 LAN port | 8 Power adapter port |
| 5 HDMI™ out port | 9 Reset button |
| 6 USB-A ports | 10 Kensington™ lock |

LED ring

There is an LED behind the standby button of the Base Unit. The color and animation of the LED shows the current state of the Base Unit and its peripherals. For more information on the possible states, see the following table:

LED status	Meaning
Static white	Idle Pairing completed
Blinking white	Booting Pairing in progress Software update
Breathing white	ECO standby
Static red	Sharing
Blinking red	Error Rebooting
Off	Deep sleep

1.2 The ClickShare Button

About the ClickShare Button

The ClickShare Button is a 'USB' powered wireless device. The Button consists out of two buttons. One which manages sharing content and the other opens the ClickShare App that is embedded into the Button or installed on the device. The embedded ClickShare App is called the "Button App".

4th gen Button overview

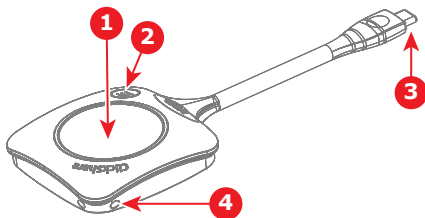

Image 1–3

- 1 Share button
- 2 ClickShare menu button
- 3 USB-C™ connector
- 4 Strap holes

Button functionality

There are two physical buttons on the Button. For more information on their functionality, see the following table:

Action	Function
Short press on share button	Starts sharing
Long press on share button	Takes over sharing
Press the menu button	Brings up or hides the ClickShare App

Button LED ring

There is an LED ring around the share button. The color and animation of the LED show the current state of the Button. For more information on the possible states, see the following table:

LED	Meaning
White fill	Setting up the connection
Steady white	Connected and ready to be used
Blinking white	Unable to connect ClickShare app not running
Fast white spinning	Device busy Device processing
Purple	Conference view without sharing
Purple - red spinning	Conference view with sharing
Steady red	Sharing
Blinking red	Error

Preparing the hardware

2

2.1	Waking the Base Unit.....	12
2.2	Pairing the Button(s).....	12

About preparing the hardware

Some hardware preparations are required before the ClickShare system can be used. Depending on the setup of the meeting room and the ClickShare configuration, the amount of preparations can vary. See the following chapters for the possible preparations.

2.1 Waking the Base Unit

About waking

Functionalities of the Base Unit are shut down when the device is in sleep mode. The Base Unit has multiple possible ways of waking up automatically. These depend on the configuration of the Base Unit and/or any connected peripherals. The following procedure explains how to manually wake the Base Unit.

How to wake

1. Push the button shortly.

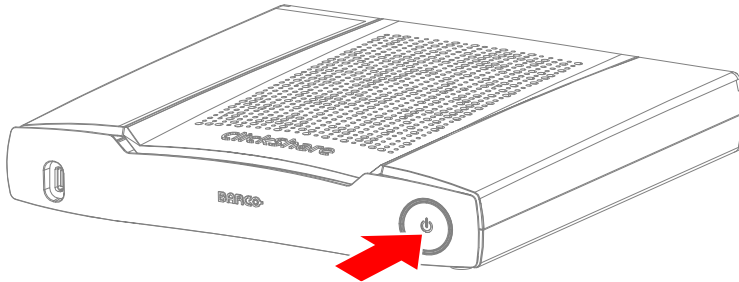

Image 2-1

The Base Unit starts up.

2.2 Pairing the Button(s)

About the pairing

Button(s) must be paired with a Base Unit before they will work. An unpaired Button will not be able to share content nor connect to ClickShare.



It is not possible to pair a Button with multiple Base Units.

Pairing a Button to a different Base Unit will overwrite the link to the previous Base Unit.

How to pair

1. Ensure the Base Unit is powered on.
2. Connect the Button to an available “USB-C” port of the Base Unit.



Note: The CX-50 Gen2 is only compatible with 4th gen Buttons. For more information about the Button, see [“The ClickShare Button”, page 9.](#)

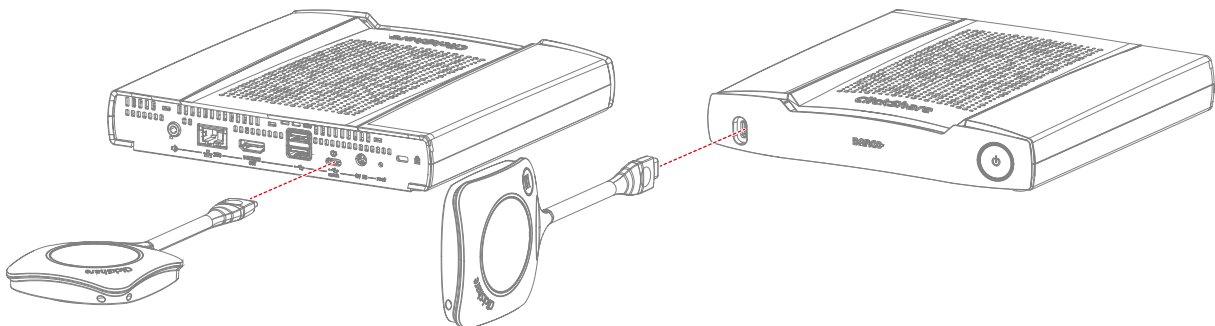

Image 2-2 Two methods to pair a Button

If a display is attached a notice “Busy pairing and updating” will appear at the bottom of the splash screen.

3. Wait until the circle of the Button turns solid green

If a display is attached a notice “Finished pairing and updating Button.” will appear at the bottom of the screen.

4. Unplug the Button from the Base Unit.
The Button is now ready to be used!

ClickShare software

3

3.1	Installing the desktop app	16
3.2	Installing the mobile app	16
3.3	App updates	18

About software

ClickShare uses various software to interact with or control the ClickShare system. The following chapters will explore the available software solutions.

3.1 Installing the desktop app

About the desktop app

Sharing through ClickShare does not require the desktop app to be installed. However, the app does enable additional features such as conferencing.



Combine both the Button and the ClickShare app for maximum flexibility and capability.

How to install

1. Choose and download the desired ClickShare desktop version from the Barco website.
2. Run and follow the instructions of the installer.
The desktop app will open
3. Click on the blue button with the text “OK, got it” to start using the desktop app.

3.2 Installing the mobile app

About the mobile app

A mobile version of the ClickShare app is available to simplify sharing to ClickShare system with smartphones and tablets.



The mobile app uses the Wi-Fi capabilities of the device to allow for sharing. Connection to other Wi-Fi networks is not possible while the app is connected to a Base Unit!

Additional features available in the mobile app:

- Clicker support.
- Screenshot / snapshot support.

How to install

1. Download and install the mobile app.
2. Open the installed mobile app on the mobile device and approve the permissions.

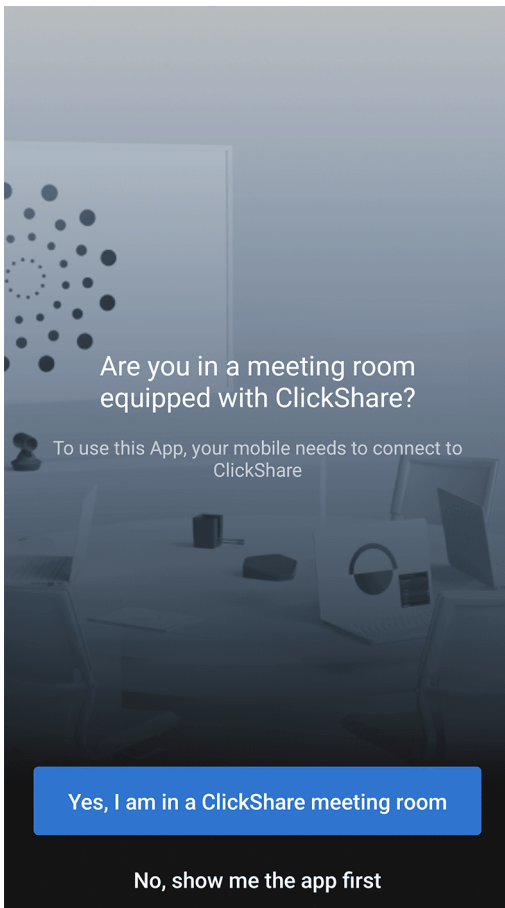

Image 3-1 Example of the android ClickShare mobile app after installation

3. Should a meeting be started now?
 - ▶ **If yes**, click on “Yes, I am in a ClickShare meeting room”. For more information, see [“Mobile app sharing”, page 29](#).
 - ▶ **If no**, click on “No, show me the app first”.

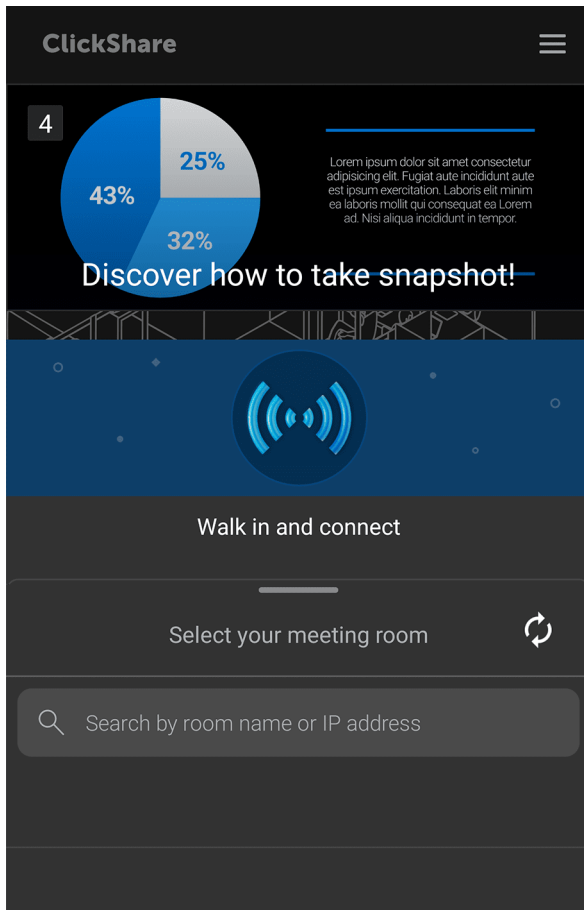

Image 3-2 Example of the home page of the android ClickShare app

3.3 App updates

About updates

The ClickShare app will automatically be kept up-to-date and download new versions in the background when available. When a new version has been downloaded the following notice will be shown:



Image 3-3 Update notice on desktop app

Not Now: Will apply the update after manual restart of the ClickShare app.

Install and Restart: Will close the ClickShare app and apply the update immediately.

Using ClickShare

4

4.1	Connect to a meeting room	20
4.2	Configuring the peripherals	25
4.3	Screen sharing	26
4.4	Conferencing	31
4.5	Additional ClickShare features	34

About using ClickShare

How to effectively use and take advantage of advanced features will be explored in this chapter.

4.1 Connect to a meeting room

4.1.1 Methods of connecting

There are multiple methods to connect with a ClickShare system:

- Button
- ClickShare app
- Desktop app and Button (**recommended**)
- PresentSense
- Wired roomdock

Depending on which method was chosen, internet access could be restricted.

4.1.2 Connecting with a Button

1. Connect a Button to a USB port of the device or with a dongle connected to the device.

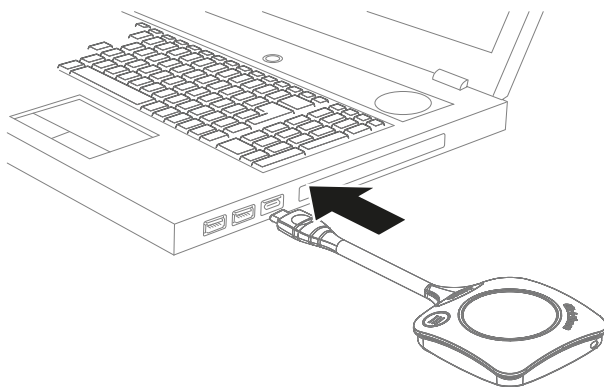



Image 4-1 Example of where to connect a Button on a laptop

 **Note:** A Button cannot be connected to a mobile device!

If the Button could not connect, see [“Pairing the Button\(s\)”, page 12.](#)

2. Wait until the LED ring is fully lit up.
Connection has been established.

4.1.3 ClickShare app



Depending on the installation, external internet access can be lost while connecting with the desktop app alone. Connecting through the mobile app will always lose external internet access!

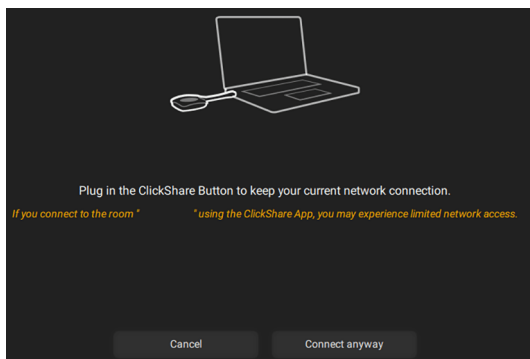

Image 4-2 Warning that network will be limited

1. Open the ClickShare app.
 - a) **For mobile**, connect to the Wi-Fi network of the ClickShare.

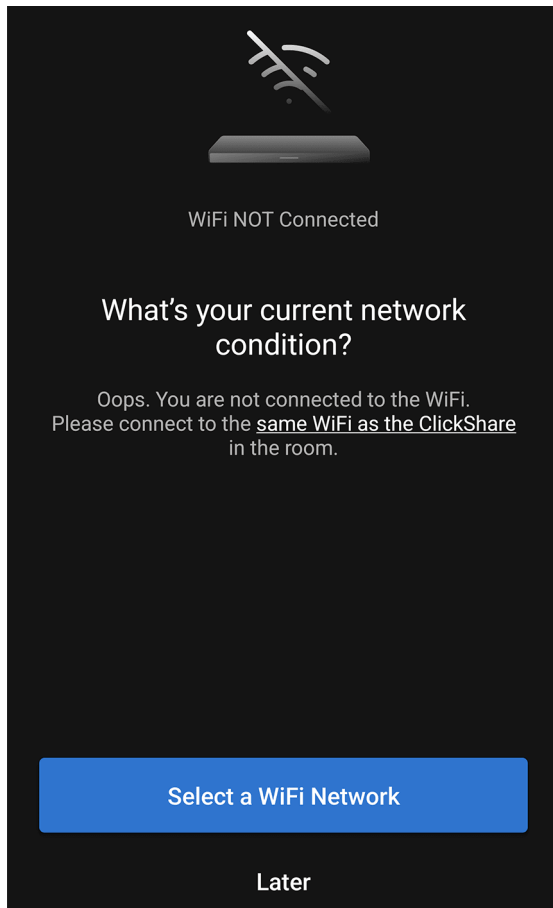

Image 4-3 Example of the connection not being correct



Note: As this is a network is not connected to the internet, some devices may give warnings when connecting.

2. Select the meeting room from the nearby meeting room options.

If the room is not present in the list, use the search bar functionality:

- Press the refresh icon at the right side of the search bar
- Type the meeting room name or IP address

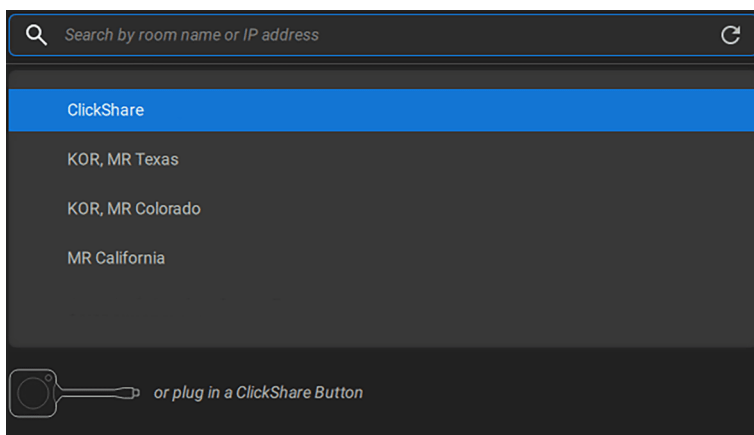

Image 4-4 Example of a room selection on desktop

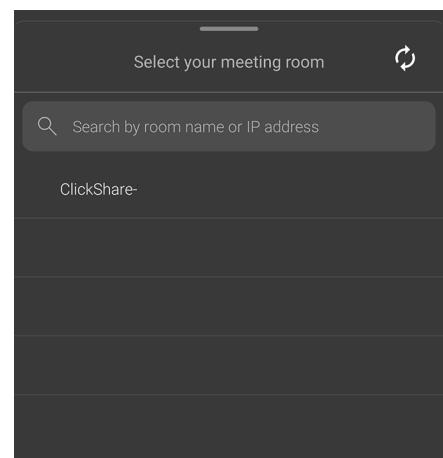

Image 4-5 Example of a room selection on mobile

3. Enter the passcode shown on the display.

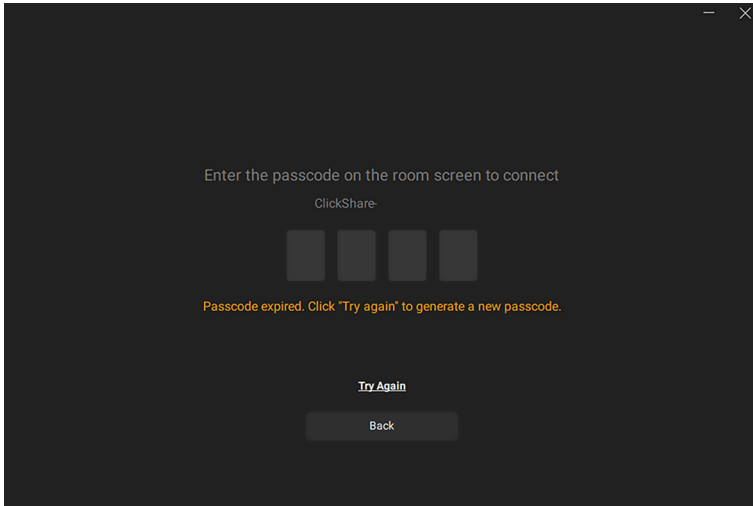

Image 4–6 Example of the passcode entry screen desktop app

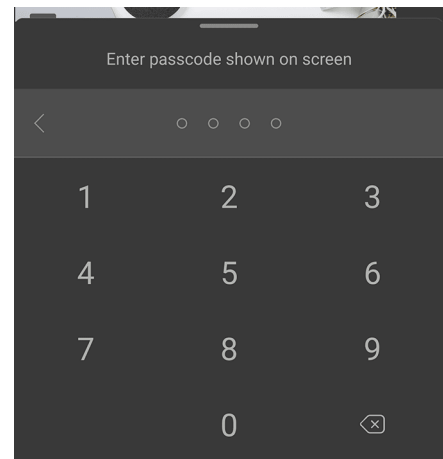

Image 4–7 Example of the passcode entry screen mobile app

 **Tip:** Press “Try Again” or “Show Passcode Again” if the passcode was not displayed long enough.

The sharing window will be displayed.

4.1.4 Button & desktop app

1. Connect a Button to a USB port of the device or with a dongle connected to the device.

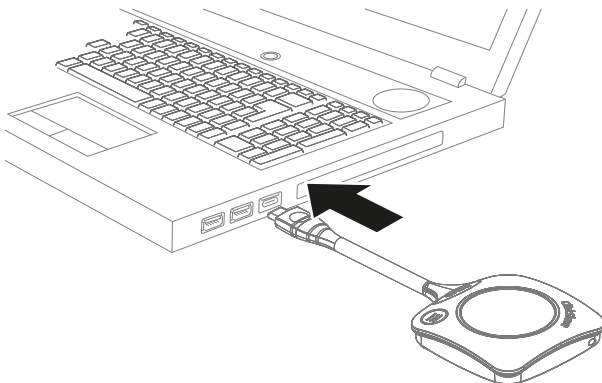

Image 4–8 Example of where to connect a Button on a laptop

If the Button could not connect, see [“Pairing the Button\(s\)”, page 12.](#)

2. Wait until the LED ring is fully lit up.
3. Are programs allowed to use autorun on the connected device?
 - ▶ If **no**, start the ClickShare app.
 - ▶ If **yes**, wait until the ClickShare app is opened automatically.

The ClickShare app will open on the sharing window.

4.1.5 PresentSense

1. Enable the PresentSense functionality in the app through one of the following three methods:
 - a) **Desktop app:** open the settings through the menu in the upper right corner and scroll to the bottom to enable PresentSense.

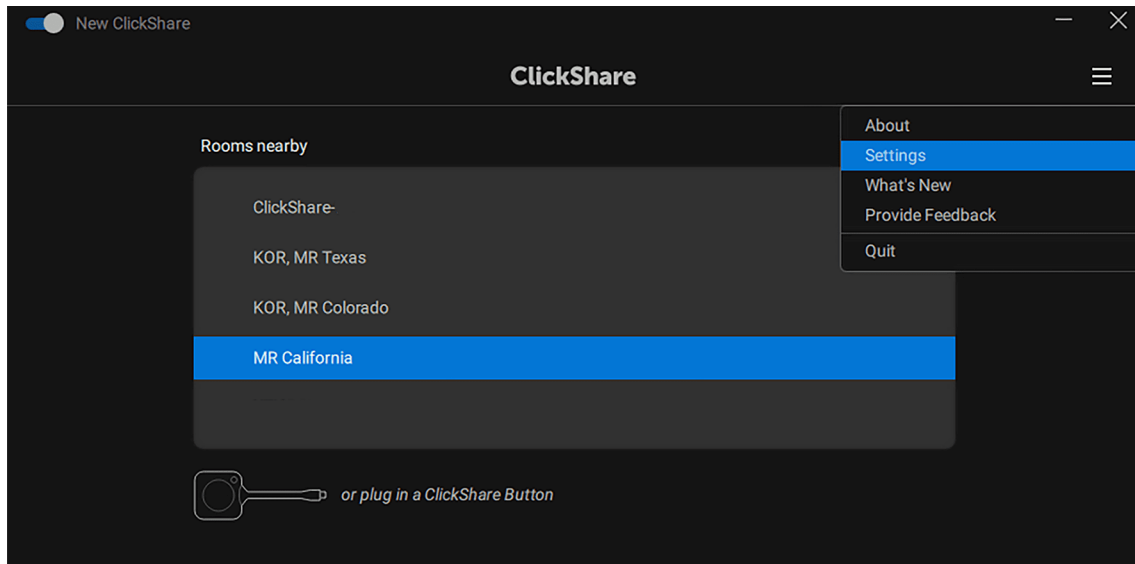

Image 4–9 Example of the desktop app settings location

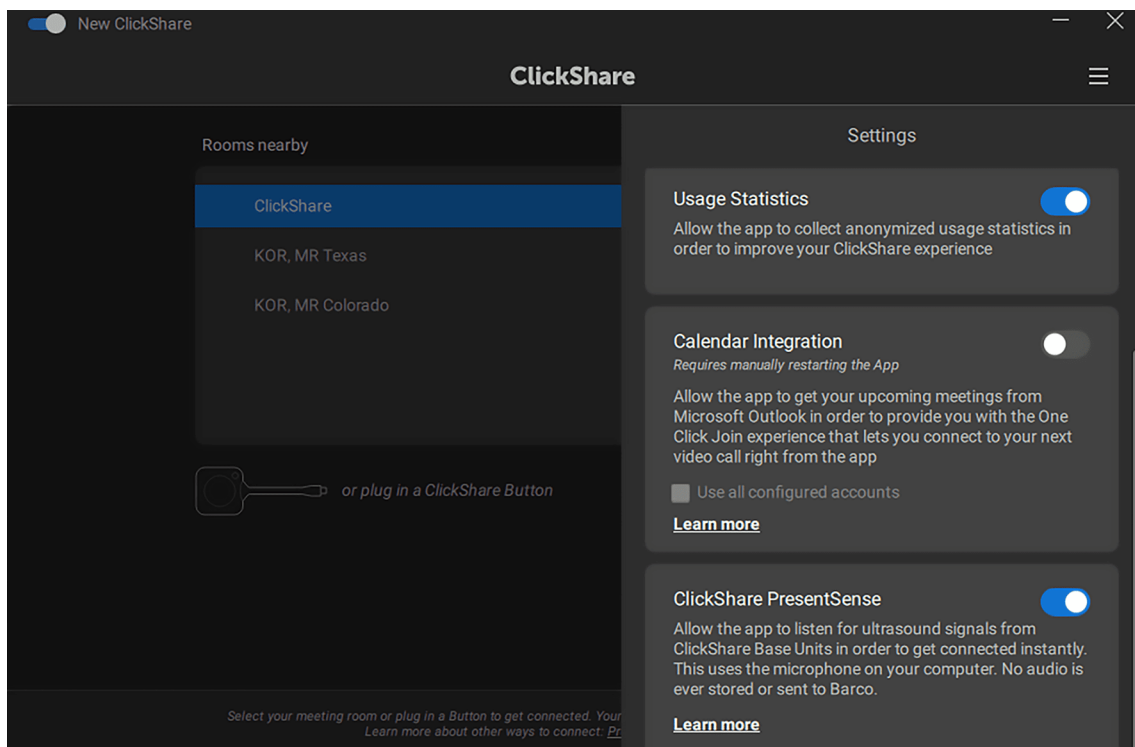

Image 4–10 Example of an enabled PresentSense settings

- b) Mobile app (homescreen):** tap on the “Walk in and connect” text or icon and tap “Enable PresentSense”.

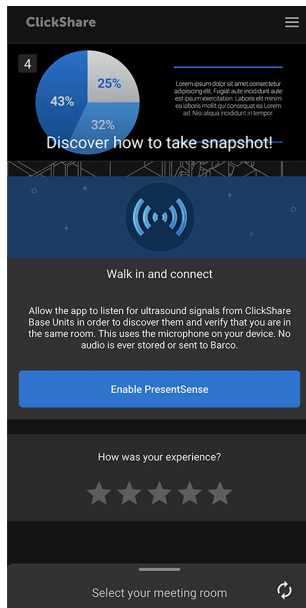

Image 4–11 Example of enabling PresentSense on the homescreen on android

- c) **Mobile app (settings):** swipe to the left or tap the menu icon in the upper right corner to open the settings and enable the PresentSense setting..

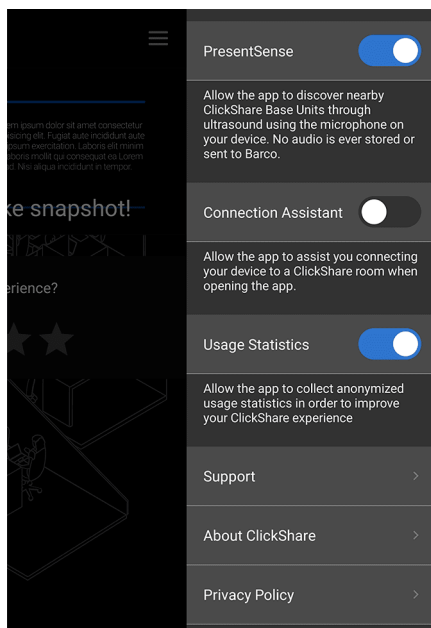

Image 4–12 Example of an enabled PresentSense settings on android

ClickShare will use the devices microphone to scan for nearby meeting rooms.

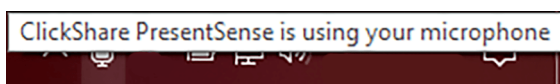

Image 4–13

2. Walk in range of the meeting room.
All nearby meeting rooms will appear on the homepage.
3. Click on the desired meeting room to start sharing.

4.1.6 Wired roomdock

About wired roomdock

ClickShare can be used with a wired connection if configured. Plug the prepared video cable into the desired device. The peripherals connected to the CX-50 Gen2 will also be made available through this connection.

4.2 Configuring the peripherals

About the peripherals

When a device is connected to ClickShare, then all of the internal and connected peripherals become available to that device. These can be used to record videos, capture screenshots or record audio from the connected device. This functionality is required to participate in conferences or for administrators to test the peripherals remotely.

When any peripheral is active on a connected device, then its icon on the bottom left of the wallpaper will turn green. When the screen content is being viewed, then a red eye icon will appear on the bottom left of the wallpaper.



Image 4–14 Example of active microphone and speakers

4.2.1 Audio configuration

Audio configuration

The connected user must control his own audio signal using the audio configuration of his computer. If he does not want to broadcast his audio signal, he has to mute audio on his computer.

For some operating system, it is necessary to set ClickShare as your default output device. Once you unplug the Button, the default setting is switched back to the previous setting. The speakerphone selection is also selected.

Audio configuration

The following configuration is the expected configuration for the playback devices when plugging the Button. ClickShare speaker as default device and room speakerphone as default communications device.

The speakerphone is available and can be used even when not on screen. The sound coming out of the speaker is only heard when sharing content. With this defaults, the content audio will be played by the speakers and communication clients (UC&C and conferencing tools) will use the room speakerphone. For best experience, the room speakerphone should be selected in the communications client at all times. Difference is that the audio from the Speakers will be lip-synced with the content, but will have higher latency. The communications device is optimized for the lowest latency possible, but no lip-sync is guaranteed with the video. For an optimal conference, the audio should always be transferred with lowest latency possible and will get priority over video.

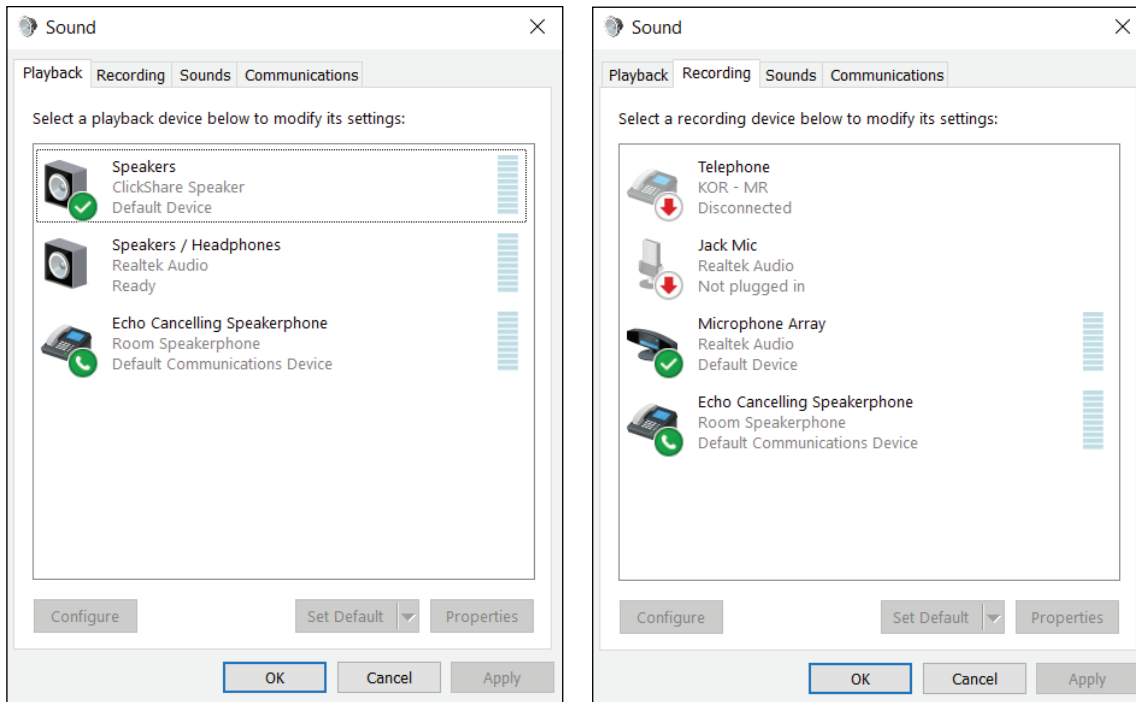

Image 4–15 Audio setup

4.3 Screen sharing

4.3.1 Methods of sharing

ClickShare enables the sharing of content on connected screen(s) from connected devices for participants in the room. While sharing the peripherals can be used to play stereo audio. If there are two displays connected to the Base Unit, it is possible to share from two separate devices at the same time.

Depending on the connection used, different options for sharing can be available.

- Sharing with a Button
- Sharing with the desktop app
- Sharing with the mobile app
- Supported third party sharing applications

4.3.2 Button sharing



Sharing will be enhanced by combining the use of a Button with the ClickShare desktop app!

The Button allows for the mirroring (sharing) of all the content currently displayed on the connected device to the meeting room monitor(s) in real time.

Pressing the central share button of the connected Button will toggle the sharing of the main screen. If multiple devices are sharing at the same time, then the content will be resized and distributed across the meeting room monitor(s).

To stop all other screens from being shared and take over sharing on the meeting room monitor(s), press and holding the central share button.

4.3.3 Desktop app sharing



Sharing will be enhanced by combining the use of a Button with the ClickShare desktop app!

About desktop sharing

There are two ways of sharing content through the desktop app:

- Sharing a window or application
- Sharing a screen

Click on the thumbnail of desired screen or application to start sharing the selected content to the meeting room monitor(s) in real time. It is possible to switch between sharing different screens or applications at any time by clicking on another thumbnail.

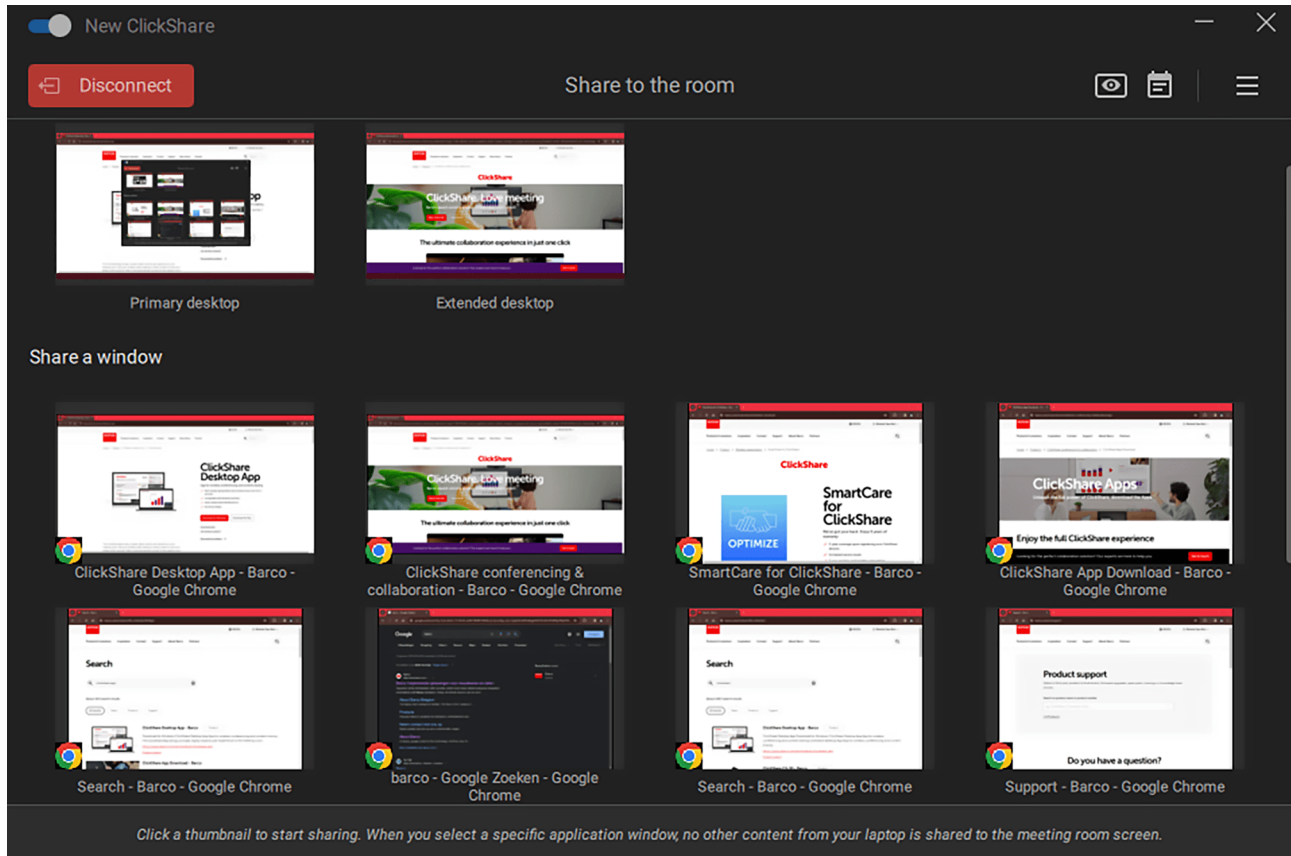

Image 4–16 Example of the sharing window

Preview display(s)

If local view is enabled on the Base Unit an eye icon in the upper right corner will be present. Clicking the eye icon will pop-up a preview window. This window will show what is currently being displayed on the meeting room monitor(s).



Preview cannot be used while content is being shared, for security reasons.



For more information on how to toggle local view, see the installation manual of the Base Unit:
<https://www.barco.com/support>.

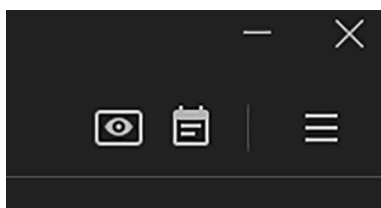

Image 4–17 Preview icon located on the left

How to share single screen

The currently shared window or application will get a red border and two advanced options as overlay:

- **Stop sharing:** disconnects the sharing functionality.
- **Pause / resume sharing:** will freeze / resume content that is being shared on the meeting room monitor.

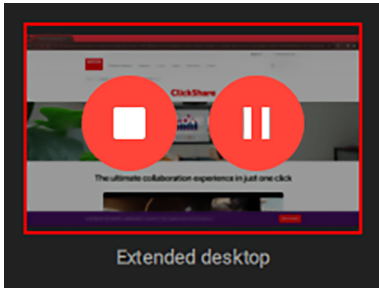

Image 4-18 Example of window being shared

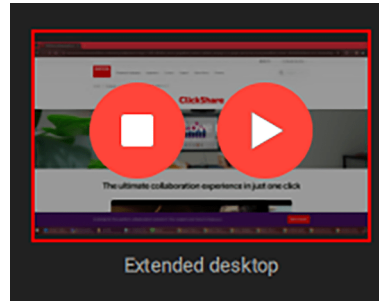

Image 4-19 Example of shared window being paused

If multiple devices are sharing at the same time, then the content will be resized and distributed across the meeting room monitor.

How to share dual screen

When sharing to two displays, two options will be available:

- Side by side
- Take over display

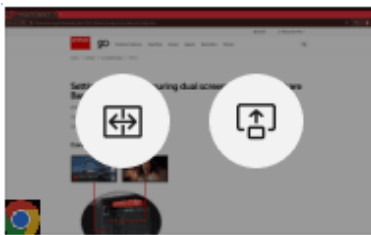

Image 4-20

The first window or desktop being shared will be displayed on both displays. Clicking on another window or desktop will give the two options again and depending on the choice something different will happen:

- Clicking **Take over display** will show the window or desktop on both displays.
- Clicking **Side by side** will show the original on the primary display and the newly selected option on the secondary display.

Content that is being shared can:

- Take over both displays
- Stop per monitor
- Pause per monitor



To share another window or desktop, one of the shared content must be stopped or the new window or desktop must take over both screens.

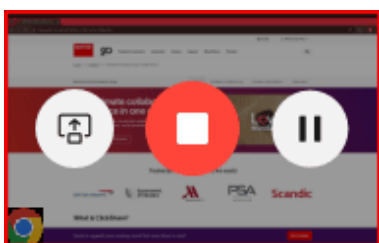

Image 4-21

4.3.4 Mobile app sharing

Start sharing

Casting or sharing the screen of the mobile device can be done by tapping the share button in the middle of the screen.

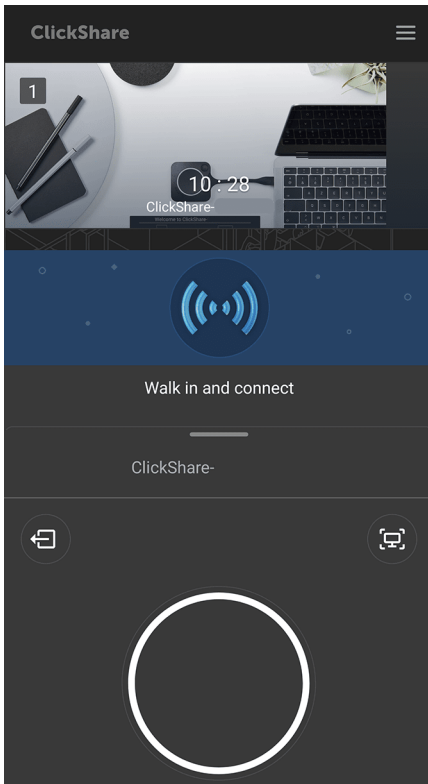

Image 4–22 Example of the share screen on android

While sharing the full currently active screen on the mobile phone will be shared in real-time. It is not possible to share specific screens nor applications, as what is seen on the mobile device, will be shown on the screen.

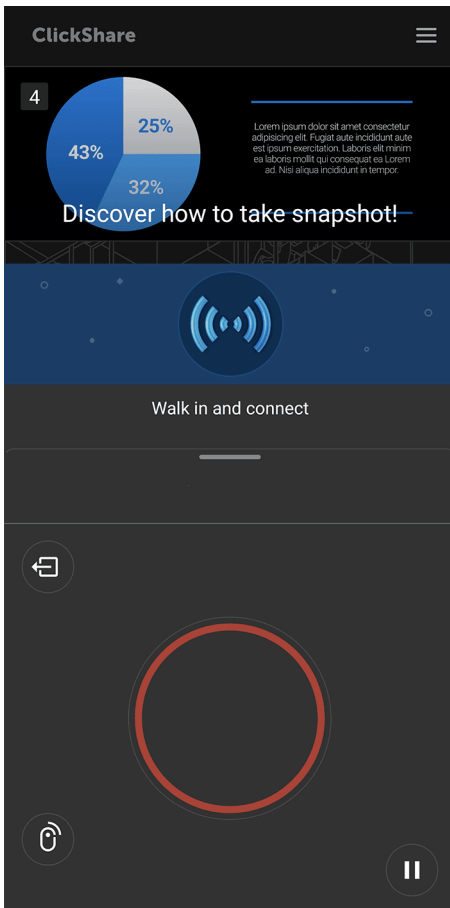

Image 4–23 Example of screen that is being shared on android

Additional features

There are three additional features available while sharing on a mobile device:

- Pause the sharing by tapping on the pause button in the bottom right corner, near the share button
- Control the screen or share with a clicker by tapping on the clicker icon at the bottom right corner, near the share button
- Take screenshots or preview of what is being displayed on the meeting room monitor(s) by tapping on the screenshot icon in the upper right corner, near the share button



Image 4–24 Example of the pause icon on android

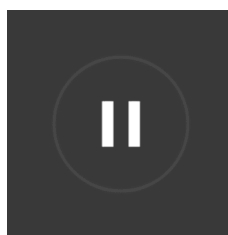

Image 4–25 Example of the clicker icon on android

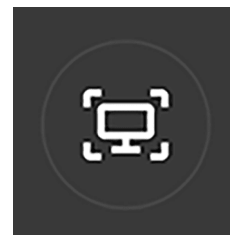

Image 4–26 Example of the screenshot icon on android

When taking a screenshot, a new window will be displayed. This window previews what will be screenshot. There are multiple options on what can be done with the taken screenshot:

- Share the screenshot over wireless connections.
- Save the screenshot locally.
- Delete the screenshot when it is no longer needed.



Image 4–27 Example of the screenshot screen on android with icons in order

4.3.5 Third party sharing

It is possible to combine the sharing functionality of certain third party apps with ClickShare.

The supported apps are:

- AirPlay
- Google cast
- Miracast

To use any of these apps, make sure that the device is connected to the Wi-Fi network of the Base Unit and start sharing. For more information on how to use these apps, refer to their respective documentation.

4.4 Conferencing

4.4.1 Methods of conferencing

ClickShare supports multiple different ways of conferencing with remote and local participants. Any connected display(s) and additional peripheral(s) can be used while conferencing.

Conferencing methods supported possible are:

- Standard conferencing.
- One click join.
- Conference view.

4.4.2 Standard conferencing

About standard conferencing

ClickShare will support and enhance the experience of joining remote meetings regardless of the meeting service used.

How to join

1. Accept the meeting invite on the remote conferencing app or website of choice.
2. Verify the inputs and outputs selected by the conferencing app or website of choice.



Note: If room peripherals are connected to the Base Unit, select the name of the peripheral in the conferencing app.

3. Join the meeting.
4. Combine conferencing with sharing for local participants (**optional**)
For more information on sharing, see [“Methods of sharing”](#), page 26.

4.4.3 One click join

About one click join

Hosting or joining a remote or hybrid meeting through ClickShare, will let ClickShare suggest the settings and simplify the room connection automatically. This reduces required time for joining a meeting to a single button click and decreases setup time while hosting.

Prerequisites

The calendar must be synced to the ClickShare App. For more information, see [“Calendar integration”](#), page 37.

How to use

1. Is the device connected to ClickShare?
 - ▶ If **yes**, go to next step.
 - ▶ If **no**, click on *Join* on the homescreen and connect to the desired meeting room.

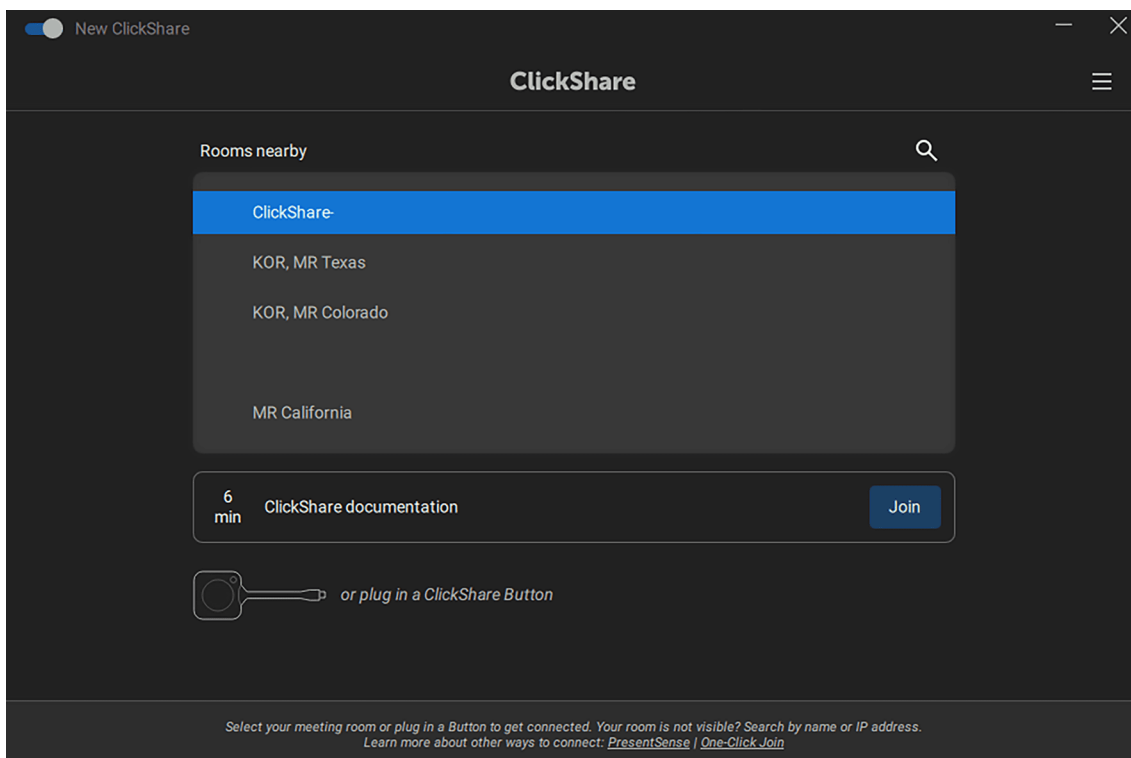

Image 4–28

2. Connect to the desired meeting room.
3. Click on the calendar icon.
4. Click on *Join* for the desired meeting.

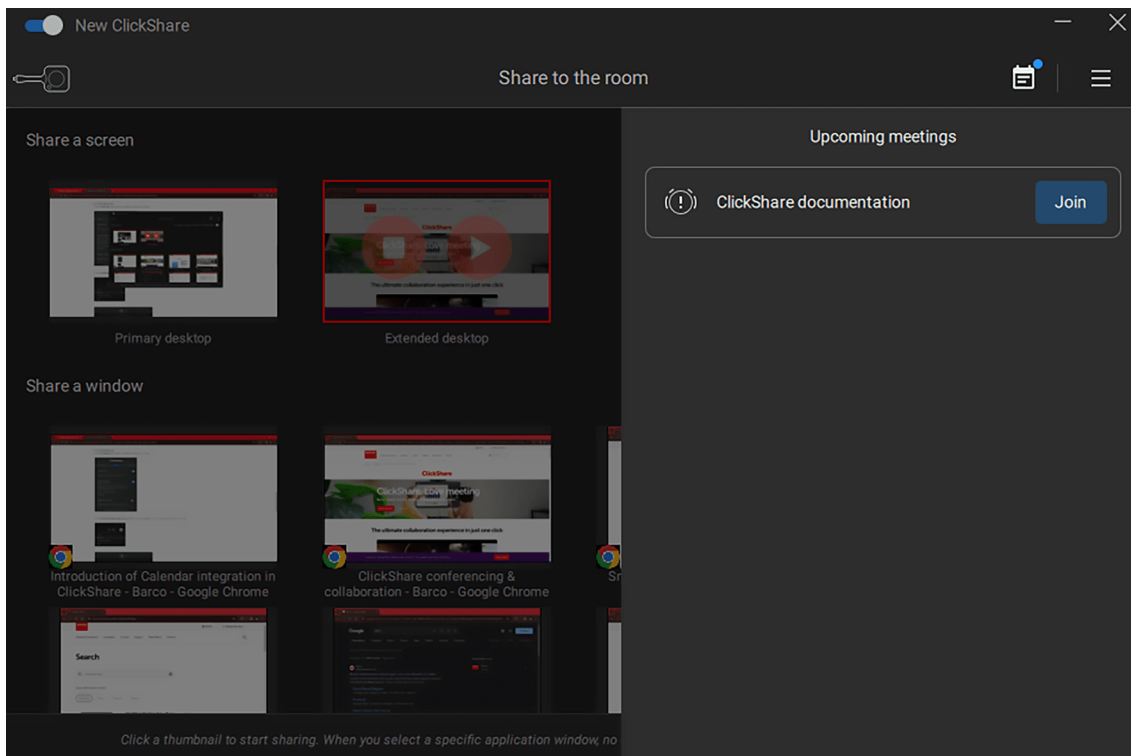

Image 4–29 Example of the calendar integration while sharing

4.4.4 Conference view

About conference view

Conference view lets content and the remote participants be shared on the room display at the same time. ClickShare provides different layouts for the content and participants to be displayed. These layouts can be changed at any time.

The used conferencing application will let the user decide which content is being shared. This selected content is then shared on the display in the room and remotely to the participants.

Prerequisites

Connect to ClickShare using one of the following methods:

- [“ClickShare app”](#), page 20.
- [“Button & desktop app”](#), page 22.

How to use

1. Join a meeting or call on a conferencing application of choice.
The ClickShare conference view window will pop-up.
2. Is someone sharing to the display?
 - ▶ If **yes**, click on *Take over* above the *Share a screen* section or in the overlay.
 - ▶ If **no**, click on *Share Microsoft Teams on the room display* in the overlay.

A blue rectangular button with the text "Take over" in white.

Image 4–30

A blue rectangular button with the text "Share Microsoft Teams on the room display" in white.

Image 4–31

The ClickShare App will be minimized.

3. Share desired content using the conferencing application.

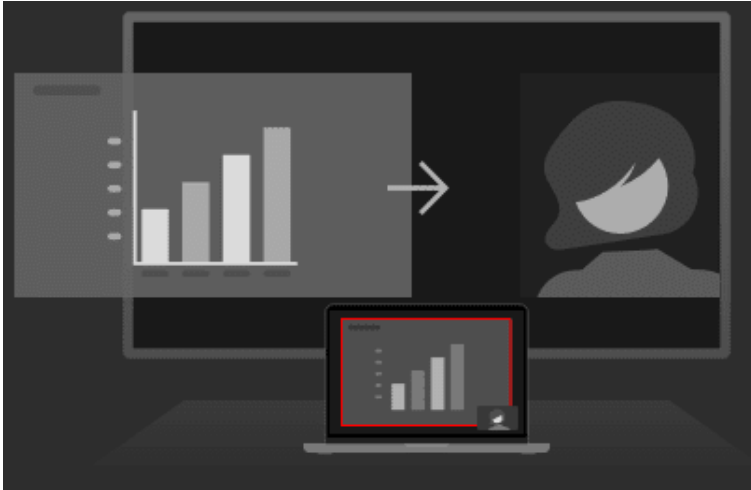

Image 4-32

The content will automatically be displayed on the local display.

4. Click on the desired layout of content and participants in the ClickShare App.



Tip: The layout with the red border is the currently active layout.



Tip: If the meeting room has two displays connected to ClickShare, then the participants will be displayed on one screen and the content on the other.

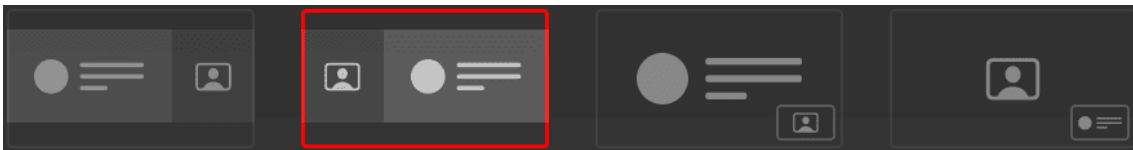

Image 4-33

5. Click on *Stop Sharing* to leave conference view. **(optional)**

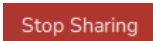

Image 4-34

6. Click on *Share* above the *Share a screen* section to enter conference view again. **(optional)**

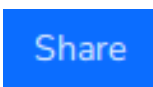

Image 4-35

4.5 Additional ClickShare features

About Additional features

Huge variety in meeting room configurations and setups are possible with ClickShare. To support and allow this variety in configurations additional features have been implemented into ClickShare. These features will be explored in this chapter.

4.5.1 Blackboarding & annotations

About blackboarding & annotations



Only available when the display is a touch screen.

The connected touch screen display can be configured as a writing board. Allowing for notes or sketches to be made on top of a displayed image or on a white background. These notes and sketches can also be saved onto a USB-stick connected to the Base Unit or the local storage of a Button connected device.

There are two methods of creating drawings:

- On a clean background.
- On a shared screen or window after tapping on annotations.



Image 4–36 Example of icon to start annotations

Creating drawings

While in blackboarding or annotation mode, different icons to create or manage drawings will be enabled.

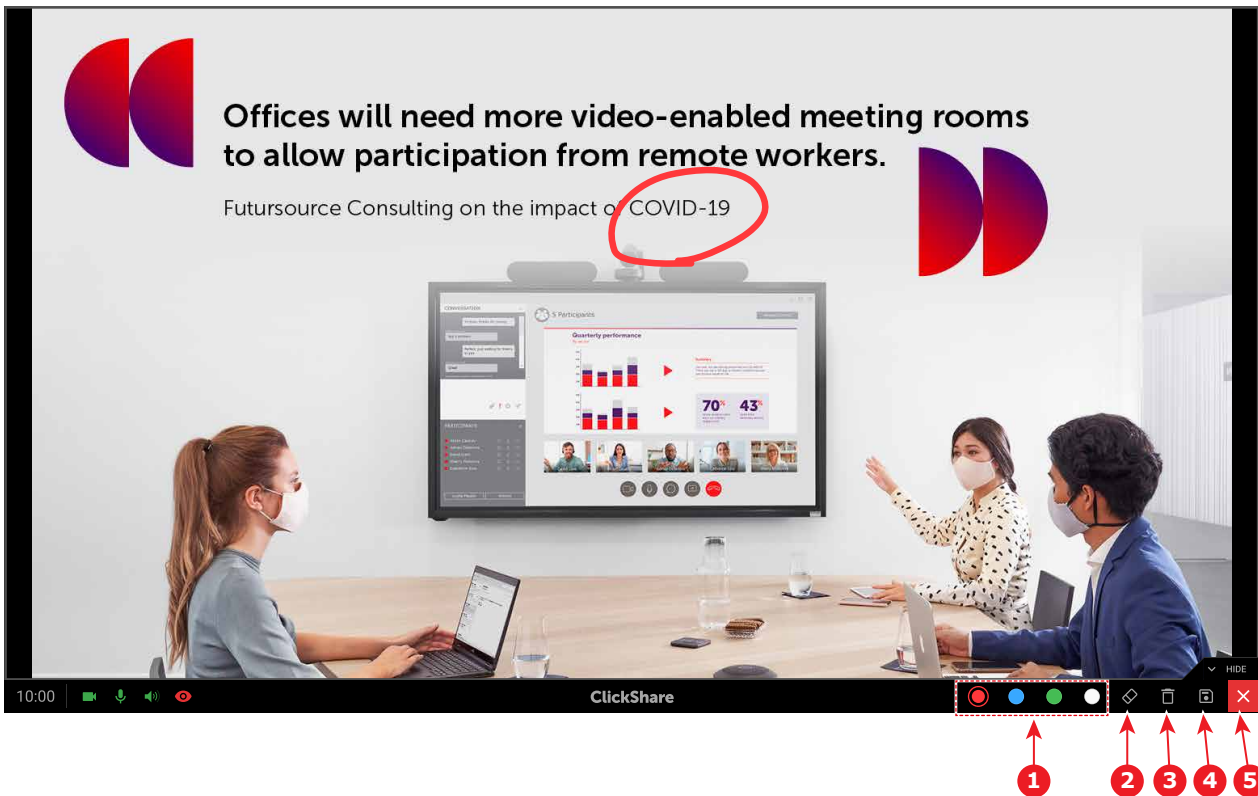

Image 4–37 Example of a screen in annotation mode

- Tap on the pen tool to start drawing on the screen. While the pen tool is selected, any touch actions within the active screen will result in additional drawings.
- Tap on the desired color to switch the currently active color. (reference 1, [Image 4–37](#))
- Remove some lines or delete mistakes by tapping on the eraser icon and swiping over the parts that must be deleted. (reference 2, [Image 4–37](#))
- Delete all made drawings by tapping on the clear option. (reference 3, [Image 4–37](#))

Saving drawings

Tap on the save icon if the created drawings, and in case of annotations their background, must be saved for future reference. (reference 4, [Image 4–37](#))

After tapping, the drawings, and in case of annotations their background, will automatically be saved to a USB stick that is connected to the Base Unit. All Button connected device will also receive a pop-up requesting to save a copy locally. The file will be named after the meeting room and the current date.



Black and white lines will be inverted during saving. Meaning black lines become white and white lines become black.

Presenter mode

To stop using blackboarding & annotations, tap the close icon. (reference 5, [Image 4–37](#))

This will erase any drawings that were made during annotation mode, however drawings that were made in blackboard mode **will be restored** when re-entering blackboarding.

4.5.2 Touch back

About touch back



Only available when the display is a touch screen.

Allows for the controlling of the connected device through presses on the connected touch screen, preventing the need to remain near the connected device or control it with a mouse.

Touch back can be disabled by pressing the touch back icon in the middle of the bottom right icons.



Image 4-38 Touchback icon

4.5.3 PowerPoint presenter mode

About PowerPoint presenter

To view notes made in Microsoft Office PowerPoint, presenter mode can be used. This removes the need for additional screens to hold an effective presentation.



When presenting in PowerPoint without using presenter mode, ClickShare will remind the user of the feature automatically.

How to use PowerPoint presenter mode

1. Open the desired PowerPoint in Microsoft Office PowerPoint.
2. Start the presentation.
3. Share the presentation screen with the chosen ClickShare connection. For more information, see [“Methods of connecting”, page 20](#)
4. Right click on the slide and select “Show Presenter View”.

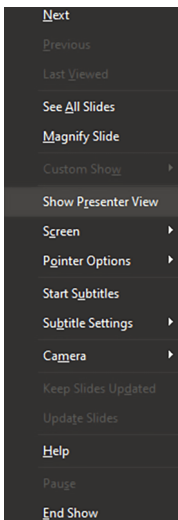

Image 4-39 Example of the right click menu in Microsoft Office PowerPoint

4.5.4 Calendar integration

About calendar integration

Lets ClickShare access and use the calendar of e-mail accounts connect to the device, to simplify joining meetings. Meeting reminders and join options will also be handled and enhanced by ClickShare.

How to enable calendar integration

1. Open the settings through the menu in the upper right corner.

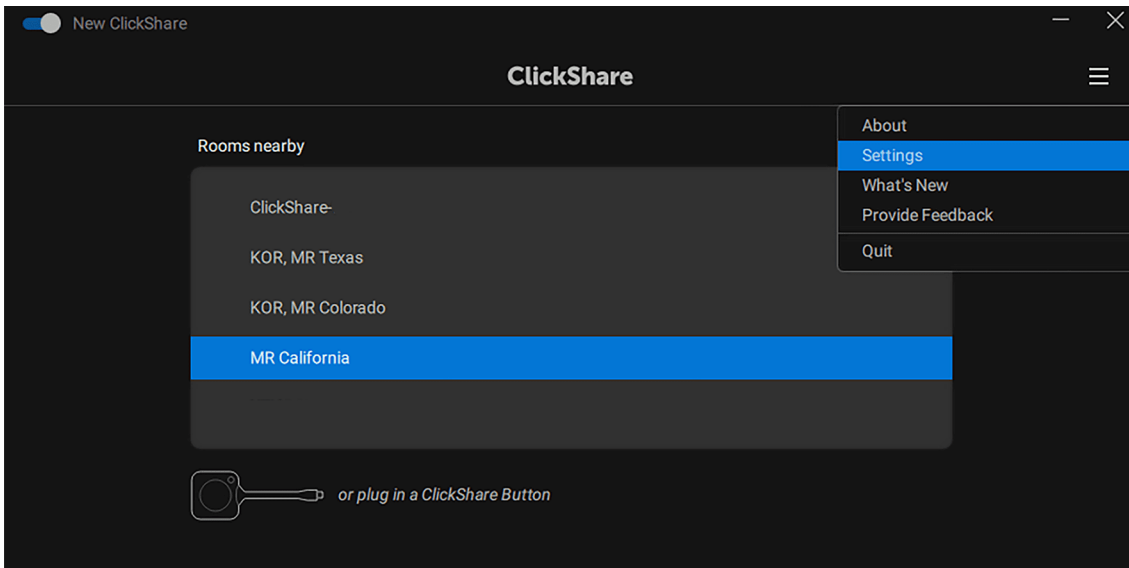

Image 4–40 Example of the desktop app settings location

2. Enabled the calendar integration functionality.

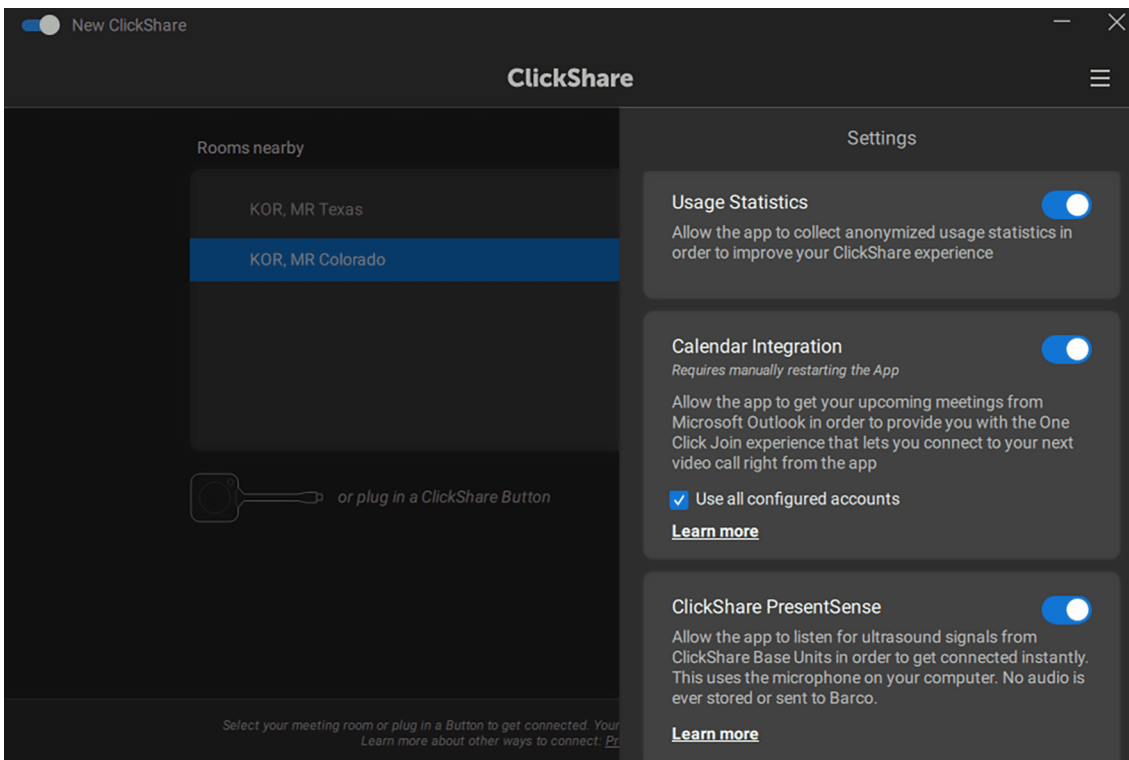



Image 4–41 Example of calendar integration enabled with all e-mail account access

 **Tip:** ClickShare can manage calendars of all connected e-mail accounts at once if the checkbox in front of “Use all configured accounts” is checked.

3. Manually close the ClickShare app.

 **Tip:** Closing the app window with the cross will not close the background processes of the app. The app must be quit or ended completely. If the attempts fail to close the app completely, restart the entire device.

4. Restart the ClickShare app.

Upcoming meetings will be visible in the ClickShare app on two locations:

- On the home screen:

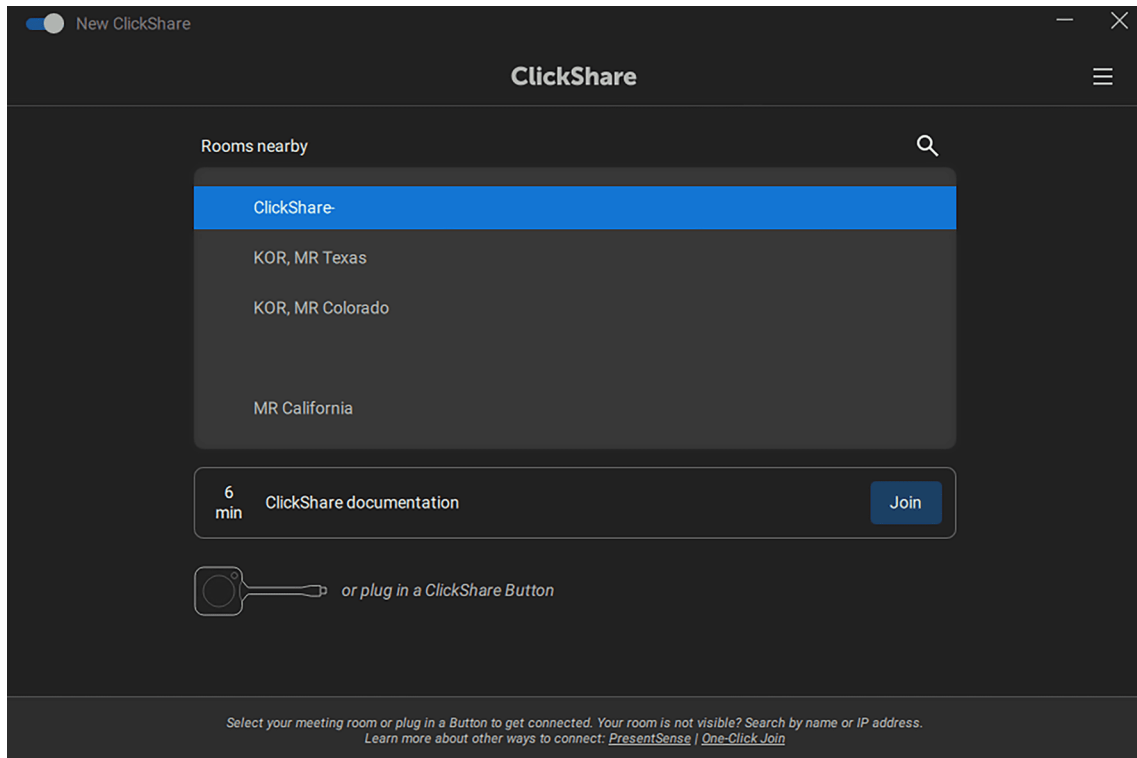

Image 4–42 Example of the calendar integration on the home screen

- While sharing after pressing the calendar icon at the top right corner:

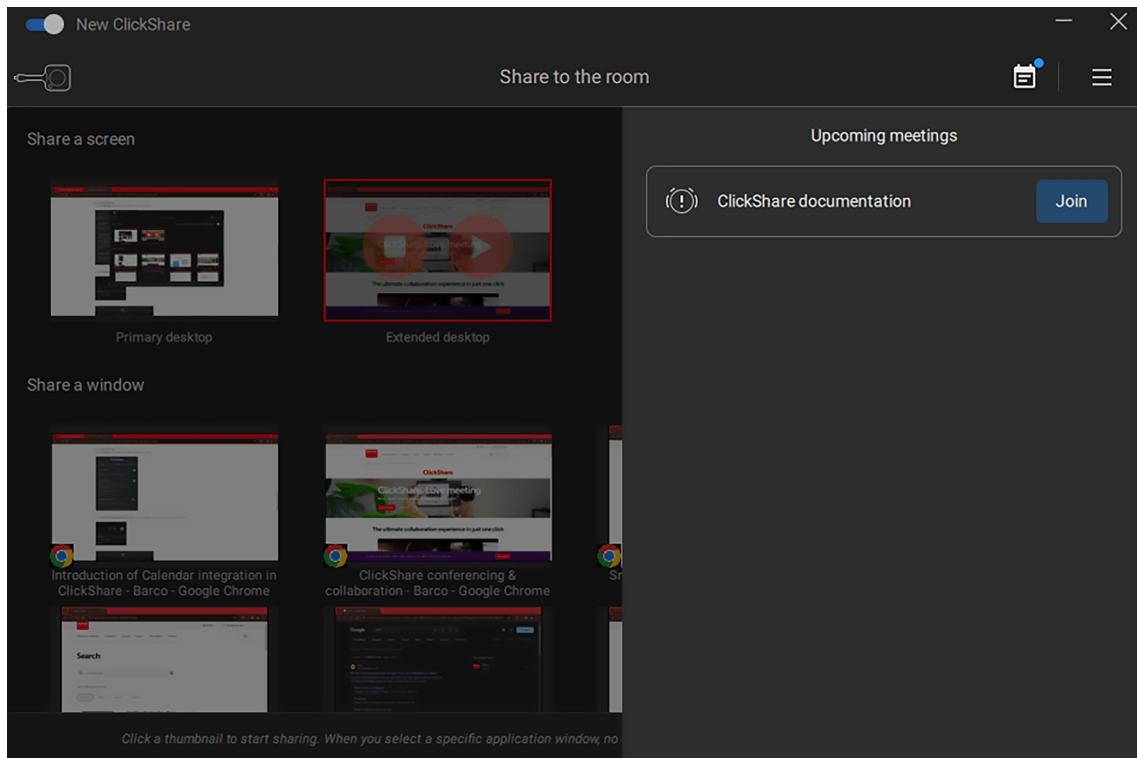

Image 4–43 Example of the calendar integration while sharing

Leaving the meeting room

5

5.1	Closing the connection	42
5.2	Hardware cleanup	42

About leaving

After the meeting has concluded or the use of the ClickShare is no longer immediately required, then this chapter will advice on some best practices to minimize the impact on the next person.

5.1 Closing the connection

About closing the connection

If the connection between the connected device(s) and ClickShare has been broken or ended abruptly, then the ClickShare system will default back to the wallpaper after some time has passed. No content will remain on screen for long periods of time, however it is still recommended to close the connection properly.

The proper methods to close the connection depend on the connection that was made and are:

- Closing with the Button
- Closing with the ClickShare app

Button connection closing

1. Press the center share button to stop the sharing.
2. Ensure no more content is being shown on the display and the wallpaper has returned.
3. Disconnect the Button(s) from their connected device(s).

ClickShare app connection closing

1. Stop sharing content by pressing the stop icon on the left of the shared screen or window in the app.

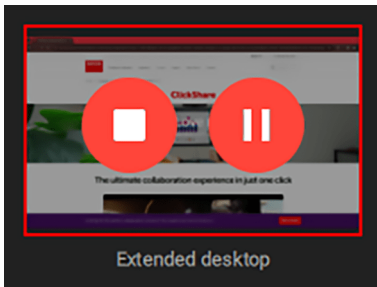

Image 5-1 Example of stop button on a shared screen

2. Disconnect from ClickShare by pressing the disconnect button in the upper left corner.

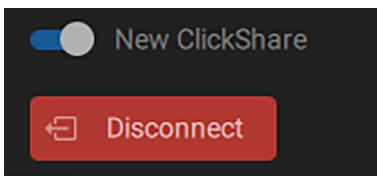

Image 5-2 Disconnect button

3. Close the app (**optional**).

5.2 Hardware cleanup

Button cleanup

Store or return the used Button(s) back to their original location in the meeting room. This helps prevent Buttons being lost or damaged and speeds up the time it can take for the next person to start using ClickShare.

Troubleshooting

6

6.1	Basic troubleshooting.....	44
-----	----------------------------	----

6.1 Basic troubleshooting

Problem solving

In this chapter some problems that might occur while using ClickShare are listed. For each problem possible causes are given and a solution is proposed. If you cannot solve the problem yourself, please contact your local IT administrator.

Generic issues

Problem	Cause	Solution
Your screen is not shown on the display when pressing the Button.	Wrong input is selected on the display.	Select the correct input on the display or on the room control system
	Base Unit in standby	Briefly push the standby button on the Base Unit or plug in a Button and run the ClickShare client software.
	You are the third person that wants to share the content to the display.	The first or second user has to push his button to remove his content so that a third user can share his content. or As third user, click and hold the Button to use the Show me function of ClickShare.
	The ClickShare client software is not running.	Go to the ClickShare drive and run the software.
Your screen is shown, but your audio is not playing on the meeting room audio system	Your audio signal on your PC is muted	Right click on the speaker icon and switch off the mute.
	Audio system of the meeting room is not switched on	Switch on the audio system of the meeting room.
	When using separate audio, audio cable is not connected	Check audio connection between the Base Unit (audio out, green connector) and the audio system of the meeting room.
	Default speaker is not correctly set	With a Button inserted, set ClickShare speaker as your default speaker.
	Buttons are not re-paired after changing the audio setting on the web interface	Re-pair the buttons.
	Audio setting on the web interface is not correctly set.	Consult your administrator to select the correct audio setting.
Your content is removed from the display and the LEDs of your Button are blinking white.	Connection to the Base Unit has been lost.	ClickShare tries to restore the connection automatically. If this fails, the LEDs of the Button start blinking red. You should unplug the Button from your laptop and start a new.
Nothing is shown on the display at all.	The display is switched off.	Switch on the display.
	Wrong input is selected.	Select the correct input.
	The display cable is not connected (correctly).	(Re)insert the display cable to the display and the Base Unit.

Problem	Cause	Solution
	The display does not recognize or is not able to display the Base Unit output resolution.	You or an administrator should change the corresponding setting via the web interface.
	The Base Unit is in standby mode.	Briefly push the standby button on the Base Unit or plug in a Button and run the ClickShare client software.
	The Base Unit is powered off.	Check if power adapter is connected to the Base unit and to the wall outlet.
	Wallpaper is disabled	If you connect a Button and start sharing, the content should be shown.
After inserting the Button into your laptop, you cannot find the ClickShare drive.	No automatic refresh of drives.	Refresh the view on your laptop.
	Bad connection at USB port on laptop.	<ul style="list-style-type: none"> • Reconnect to the USB port. • Try another USB port. • Reboot your laptop.
	Windows tries to assign the ClickShare drive to an already reserved drive letter	Use Microsoft Windows Disk Management to assign it to a free drive letter.
	IT policy not mount USB drives	Contact your IT responsible.
Some programs of Windows are not shown on the display.	Use of overlays, 3D or hardware acceleration in the GPU.	<ul style="list-style-type: none"> • Disable overlays or hardware acceleration in the GPU. • Disable AeroGlass in Windows 7 • Capture mode

Issues related to first time use and updating

Problem	Cause	Solution
Ethernet cable is inserted, but the Base Unit does not receive an IP address	Fixed IP address not configured. 802.X authentication required	Contact your IT responsible
Update server not reachable	Proxy server to be configured. Firewall is blocking the connection	Contact your IT responsible
Buttons do not connect after first time installation	Buttons not paired	Please pair the Buttons by plugging them into the USB ports of the Base Unit. Manual pairing only needs to be done once, after this, the Buttons will be automatically updated when updating the Base Unit
Unable to connect to internet	No internet available at the customer's site	Contact your IT responsible

Issues related to screen sharing (video/screen sharing)

Problem	Cause	Solution
After inserting the Button into your laptop, you cannot find the ClickShare drive.	Bad connection at USB port on laptop	Reconnect to the USB port, try another USB port, or reboot your laptop.

Problem	Cause	Solution
	Windows tries to assign the ClickShare drive to an already reserved drive letter	Use Microsoft Windows Disk Management to assign it to a free drive letter.
	Bad block on the mass storage	Please re-pair the Button with the Base Unit to restore the flash
I cannot start the ClickShare App	Running 3rd party applications is blocked by IT	Contact your IT responsible. In the meantime, you can share your screen using your device's native protocols
	You are using a Linux PC or ChromeBook	Use the device's native protocols to share on screen
Button LEDs are blinking	Clickshare Application has not been started	Start the application on the ClickShare Button's mass storage or download and run the ClickShare Desktop App.
Screen is not shown when pressing the Button although Button LED is static white.	Already two people on screen	Long press the Button to kick off all other sources from screen. Or ask for somebody to remove its source from screen
	Somebody is moderating the session	Request the moderator to put you on screen or claim the moderation role from the ClickShare application
Your shared content becomes grayed out.	Connection between the ClickShare application (or Button) and the Base Unit is lost	ClickShare tries to restore the connection automatically. If this fails, the LEDs of the Button start blinking red. You should unplug the Button from your laptop and start a new
Button cannot connect to the Base Unit. Button LEDs keep spinning.	Button is not paired to correct Base Unit.	Pair the Buttons with the Base Unit .
	Base Unit settings have changed and Button has not been paired again.	Pair the Buttons with the Base Unit.
When network integrated, the Button cannot find the Base Unit.	IP address of the Base Unit has changed.	Pair the Buttons with the Base Unit.
	The Button cannot connect to the Base Unit due to firewall settings.	Contact your IT responsible.
Quality of the image displayed is not satisfactory.	Button is using a channel with high utilization.	Contact your IT responsible.
	Base Unit antennas are obstructed.	Make sure no insulation or metal plating or a cage is placed around the Base Unit. If too far, place the Base Unit closer to the location of the Buttons. Preferably, have line of sight between Base Unit and Button.
	Low signal strength	Place the Base Unit closer to the location of the Buttons. Check the settings of the Base Unit to see if the power of the wireless signal has not been set too low.

Problem	Cause	Solution
	Laptop performance	<p>If the video performance is acceptable with a higher performing laptop, laptop performance might be the cause of bad video playback. To reduce the load on the laptop, you can:</p> <ul style="list-style-type: none"> • Lower the resolution of the laptop screen • Use application sharing in the ClickShare app to only share a part of the screen. • Disable hardware acceleration for video. • Disable extended screen sharing
Some programs of Windows are not shown on the display.	Use of overlays, 3D or hardware acceleration in the GPU.	<p>Disable overlays or hardware acceleration in the GPU. In Windows 7, disable AeroGlass.</p>
Unable to share from extended desktop.	Mac OS	<p>The Clickshare Extension pack only works with Windows. This feature is available to Mac users through Airplay. An alternative is to use the Window sharing functionality in the ClickShare Desktop App</p>
	Extension pack not installed	<p>In order to have a second screen on your computer when using ClickShare, you will need to download and install the ClickShare extension pack. https://barco.com/clickshare/extensionpack</p>
	Old Extension pack installed	<p>ClickShare will only work with the latest version of the Extension Pack. Please uninstall the extension pack and install the latest version. https://barco.com/clickshare/extensionpack</p>

Issues related to screen sharing (audio of shared content)

Problem	Cause	Solution
Your screen is shown, but your audio is not playing on the meeting room audio system.	Your audio signal on your PC is muted.	Right click on the speaker icon and switch off the mute.
	Audio system of the meeting room is not switched on or not connected.	Switch on the audio system of the meeting room. Check audio connection between the Base Unit and the audio system of the meeting room.
There is no ClickShare audio device for me to select on my computer.	Audio output of the Base Unit is not correctly configured.	Ask your administrator to configure audio of the Base Unit.
	Audio device is not available in my OS when I plug in the Button after changing audio settings on my Base Unit.	Re-pair the Buttons with the Base Unit.

Problem	Cause	Solution
ClickShare audio device is visible, but sound is coming out of my own device or other audio device connected to my computer.	Audio output of the Button is not selected.	In Windows, left click on the speaker icon and select the ClickShare Speaker.
	ClickShare speaker is not selected as default device.	In Windows, right click on the speaker icon and select "Playback devices". In the Playback tab, right click on the ClickShare Speaker and select as "Default device", on the ClickShare Speakerphone if available, right click and select as "Default communications device".
Audio is heard in the room while not sharing on the big screen.	ClickShare speakerphone is selected as default device.	In Windows, right click on the speaker icon and select "Playback devices". In the Playback tab, right click on the ClickShare Speaker and select as "Default device", on the ClickShare Speakerphone if available, right click and select as "Default communications device".
Audio and video are not in sync.	ClickShare speakerphone is selected as audio device.	In Windows, left click on the speaker icon and select the ClickShare Speaker See also above for to select the ClickShare Speaker as default audio device.

Specifications

A

A.1	Base Unit specifications	50
A.2	Button specifications	51

A.1 Base Unit specifications

CX-50 Gen2 specifications

Operating system	Windows 10 or higher macOS 11 (BigSur) and higher Android v11 and higher (ClickShare App) iOS 14 and higher (ClickShare App)
System requirements	For a smooth experience with Microsoft Teams or Zoom Minimum: Windows processor Intel Core i3 or AMD Ryzen 5/macOS: Intel Core i3 or Apple Silicon M1; RAM 8GB; OS version: Windows 10 20H2/ macOS 11 Big Sur Recommended: Windows processor Intel Core i5/Ultra 5 or AMD Ryzen 7/macOS: Apple Silicon M3; RAM 8GB; OS version: Windows 11 latest build/macOS latest build
Video outputs	HDMI: 3840*2160 @ 60Hz, HDMI 2.1 Source USB-C: 3840*2160 @ 60Hz, DisplayPort Alternate mode Source with DisplayPort v1.2
Video inputs	USB-C: 3840*2160 @ 30Hz, DisplayPort Alternate mode Sink with DisplayPort v1.2
Audio output	USB, jack, HDMI
ClickShare Buttons	2
ClickShare App	Desktop & Mobile
Native protocols	Airplay, Google Cast, Miracast
Maximum sources simultaneously on screen	2
Noise Level	Max. 25dBA @ 0-30°C Max. 30dBA @ 30-40°C
Wired authentication	802.1x, EAP-TLS, EAP-TTLS, PEAP.
SoftAP client mode	802.1X EAP-TLS, EAP-TTLS, PEAP, and WPA2 PSK.
Authentication protocol	WPA2-PSK in stand alone mode WPA2-PSK or IEEE 802.1X using the ClickShare Button in network integration mode
Wireless transmission protocol	IEEE 802.11 a/g/n/ac and IEEE 802.15.1
Reach	Max. 30m (100 ft) between ClickShare Button and ClickShare Base Unit Frequency band 2.4 GHZ and 5 GHz (DFS)
Frequency band	2.4 GHZ and 5 GHz (DFS channels supported in select number of countries)
Connections	1x Ethernet LAN 1Gbit 1x USB-C 2.0 (back); 2x USB-A 2.0 (back); 1x USB -A 2.0 (front) Audio analog line out on mini jack socket (3.5mm), digital S/PDIF
Temperature range	Operating: 0°C to +40°C (+32°F to +104°F) Max: 35°C (95°F) at 3000m Storage: -20°C to +60°C (-4°F to +140°F)
Humidity	Storage: 0 to 90% relative humidity, non-condensing Operation: 0 to 85% relative humidity, non-condensing
Anti-theft system	Kensington lock

Certifications	FCC/CE
Touch screen support & Interactivity	Yes
Wireless conferencing	via App or Button
Local view	High quality
Network connection	LAN & WiFi (dual)
Management and reporting	Yes
Warranty	1 year standard. 5 years coverage upon registering via SmartCare
Dimensions (HxWxD)	39mm x 200mm x 202mm
Power consumption	Operational: 50W (max) Standby: <8W (networked standby), < 0.5W (deep standby mode)
Power supply	Standard 110/220 V AC plug
Weight	900 gr

A.2 Button specifications

4th gen Button specifications

Connectors	USB-C type
Authentication protocol	WPA2-PSK in stand alone mode WPA2-PSK or IEEE 802.1X in network integration mode
Wireless transmission protocol	IEEE 802.11 a/b/g/n/ac
Frequency band	2.4 GHZ and 5 GHz
Dimensions (HxWxD)	14.6 mm x 59.3 mm x 161.39 mm / 0.57" x 2.354" x 6.354"
Power consumption	Powered over USB 5V DC 350mA Typical 500mA Maximum
Weight	60 gr - 0.132 lb

Regulatory

B

B.1	Product and contact references	54
B.2	International safety standards	54
B.3	Product compliance EU	54
B.4	Product compliance UK	56
B.5	Product compliance Ukraine	57
B.6	Product compliance Russia	58
B.7	Product compliance Turkey	58
B.8	Product compliance US	58
B.9	Product compliance Canada	59
B.10	Product compliance Brazil	61
B.11	Product compliance Mexico	61
B.12	Product compliance Korea	62
B.13	Product compliance Taiwan	63
B.14	Product compliance China	64
B.15	Product compliance Thailand	65
B.16	Product compliance India	65
B.17	Product privacy statement	65
B.18	Trademark notice	66

B.1 Product and contact references

Made in information

The made in country is indicated on the product ID label on the product itself.

Production date

The month and year of production is indicated on the product ID label on the product itself.

Manufacturer address

Refer to the cover page of this manual for the manufacturer address.

Importers contact information

To find your local importer, contact Barco directly or one of Barco's regional offices via the contact information given on Barco's web site, <https://www.barco.com>.

B.2 International safety standards

Standards overview

This equipment is built in accordance with the requirements of the international safety standards (IEC60950-1, EN60950-1, UL60950-1, IEC62368-1, EN62368-1, UL62368-1, CAN/CSA C22.2 No.60950-1), which are the safety standards of information technology equipment including electrical business equipment. These safety standards impose important requirements on the use of safety critical components, materials and insulation, in order to protect the user or operator against risk of electric shock and energy hazard and having access to live parts. Safety standards also impose limits to the internal and external temperature rises, radiation levels, mechanical stability and strength, enclosure construction and protection against the risk of fire. Simulated single fault condition testing ensures the safety of the equipment to the user even when the equipment's normal operation fails.

B.3 Product compliance EU

EN55032-CISPR32 Class B ITE (Information Technology Equipment)

This is a class B product. In a domestic environment this product may cause radio interference in which case the user may be required to take adequate measures.

If this equipment does cause interference to radio or television reception, the user may try to correct the interference by one or more of the following measures :

- Re-orientation of the receiving antenna for the radio or television.
- Relocate the equipment with respect to the receiver.
- Plug the equipment into a different outlet so that the equipment and receiver are on different branch circuits.
- Fasten cables connectors to the equipment by mounting screws.

European Union



Batteries, battery packs, and accumulators should not be disposed of as unsorted household waste. Please use the public collection system to return, recycle, or treat them in compliance with the local regulations.

Avoid:

- high or low extreme temperatures that a battery can be subjected to during use, storage or transportation; and low air pressure at high altitude.

- leaving a battery in an extremely high temperature surrounding environment that can result in an explosion or the leakage of flammable liquid or gas.
- a battery subjected to extremely low air pressure that may result in an explosion or the leakage of flammable liquid or gas.

Disposal Information



Waste Electrical and Electronic Equipment (WEEE)

This symbol on the product indicates that, under the European Directive 2012/19/EU governing waste from electrical and electronic equipment, this product must not be disposed of with other municipal waste. Please dispose of your waste equipment by handing it over to a designated collection point for the recycling of waste electrical and electronic equipment. To prevent possible harm to the environment or human health from uncontrolled waste disposal, please separate these items from other types of waste and recycle them responsibly to promote the sustainable reuse of material resources.

For more information about recycling of this product, please contact your local city office or your municipal waste disposal service. For details, please visit the Barco website at: <https://www.barco.com/about/sustainability/waste-of-electronic-equipment-customers>

Disposal of batteries in the product



This product contains batteries covered by the Directive 2006/66/EC which must be collected and disposed of separately from municipal waste.

If the battery contains more than the specified values of lead (Pb), mercury (Hg) or cadmium (Cd), these chemical symbols will appear below the crossed-out wheeled bin symbol.

By participating in separate collection of batteries, you will help to ensure proper disposal and to prevent potential negative effects on the environment and human health.

CE Certification



AT	BE	BG	CH	CY
CZ	DK	DE	EE	IE
EL	ES	FI	FR	HR
HU	IS	IT	LI	LV
LT	LU	NL	NO	PL
PT	RO	SE	SI	SK
TR	UK			

C5011S (R9861622EU) are fit for use in all European Union countries, EFTA and Turkey.

The C5011S is restricted to indoor use only when operating in the 5150 MHz to 5350 MHz frequency range.

Hereby, Barco NV declares that the radio equipment type C5011S is in compliance with the Directive 2014/53/EU. The full text of the EU declaration of conformity is available at the following internet address:

<https://www.barco.com/en/support/docs/TDE12448> (Base Unit)

For 2.4 GHz band:

- 2402 MHz - 2482 MHz
- Max EIRP: 19.61 dBm

For 5 GHz band:

- 5150 MHz - 5350 MHz
- 5470 MHz - 5725 MHz
- Max EIRP: 22.79 dBm

<https://www.barco.com/en/support/docs/TDE11524> (Button gen4)

The ClickShare Button has been tested and meets the EU RF exposure standards. The maximum SAR value reported is 0.678 W/kg.

For 2.4 GHz band:

- 2402 MHz - 2482 MHz
- Max EIRP: 19.88 dBm

For 5 GHz band:

- 5150 MHz - 5350 MHz
- 5470 MHz - 5850 MHz
- Max EIRP: 20.28 dBm

<https://www.barco.com/en/support/docs/TDE11913> (Button gen4.1)

The ClickShare Button has been tested and meets the EU RF exposure standards. The maximum SAR value reported is 0.164 W/kg.

For 2.4 GHz band:

- 2402 MHz - 2482 MHz
- Max EIRP: 19.93 dBm

For 5 GHz band:

- 5150 MHz - 5350 MHz
- 5470 MHz - 5850 MHz
- Max EIRP: 22.99 dBm

B.4 Product compliance UK

UK Compliance

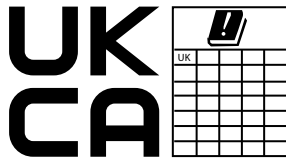

C5011S (R9861622EU) are fit for use in the UK.

The C5011S is restricted to indoor use only when operating in the 5150 MHz to 5350 MHz frequency range.

Hereby, Barco NV declares that the radio equipment type C5011S is in compliance with the Radio Equipment Regulations 2017: Great Britain. The full text of the UK declaration of conformity is available at the following internet address:

<https://www.barco.com/en/support/docs/TDE12473> (Base Unit)

For 2.4 GHz band:

- 2402 MHz - 2482 MHz
- Max EIRP: 19.61 dBm

For 5 GHz band:

- 5150 MHz - 5350 MHz
- 5470 MHz - 5725 MHz
- Max EIRP: 22.79 dBm

<https://www.barco.com/en/support/docs/TDE11513> (Button gen4)

For 2.4 GHz band:

- 2402 MHz - 2482 MHz
- Max EIRP: 19.88 dBm

For 5 GHz band:

- 5150 MHz - 5350 MHz
- 5470 MHz - 5850 MHz
- Max EIRP: 20.28 dBm

<https://www.barco.com/en/support/docs/TDE11921> (Button gen4.1)

For 2.4 GHz band:

- 2402 MHz - 2482 MHz
- Max EIRP: 19.93 dBm

For 5 GHz band:

- 5150 MHz - 5350 MHz
- 5470 MHz - 5850 MHz
- Max EIRP: 22.99 dBm

Authorised
Representative:

Barco UK Ltd

Address:

Building 329, Doncastle Road
Bracknell RG12 8PE, Berkshire, United Kingdom

Importer:

- Midwich Ltd, Vince's Rd, Diss IP98 6BB
- Exertis UK Ltd, Chineham Park, Crockford Ln, Chineham, Basingstoke RG24 8EH

B.5 Product compliance Ukraine

Відповідність вимогам України



Технічний регламент радіообладнання, затвердженого Постановою Кабінету Міністрів України від 24 травня 2017 р. №355:

справжнім «Barco NV» заявляє, що тип радіообладнання: Безпроводова система конференцзв'язку (ClickShare) моделі C5011S відповідає Технічному регламенту радіообладнання.

Повний текст декларації про відповідність доступний на веб-сайті за такою адресою: www.barco.com/en/support

Відповідність виробу ClickShare) моделі C5011S іншим Технічним регламентам:

- Технічному регламенту обмеження використання деяких небезпечних речовин в електричному та електронному обладнанні, затвердженого Постановою Кабінету Міністрів України від 10 березня 2017 р. №139;
- Технічного регламенту щодо вимог до екодизайну для споживання електроенергії електричним і електронним побутовим та офісним обладнанням у режимі "очікування", "вимкнено" та мережевому режимі "очікування", затвердженого Постановою Кабінету Міністрів України від 14 серпня 2019 р. №733.

Попереджаємо, що зміни або модифікації, які не будуть схвалені стороною, що забезпечує відповідність вимогам, можуть призвести до позбавлення користувача права на експлуатацію обладнання.

Вимоги щодо радіочастотного опромінення:

- Передавач виробу не можна розміщувати поруч з іншою антеною чи передавачем або експлуатувати разом із такою антеною чи передавачем.
- Виріб слід встановлювати для експлуатації таким чином, щоб відстань між випромінювачем і вашим тілом становила не менше 20 см.
- В пристрої реалізована радіотехнологія 5G NR, з офіційним впровадженням технології в Україні, виробником буде проводитися оцінка відповідності даної радіотехнології вимогам Технічного Регламенту радіообладнання.

Відомості про C5011S

Модуль Base Unit приймає бездротові сигнали від пристроїв Button, а також управляє показом вмісту в конференц-залі і периферійними пристроями, підключеними до Base Unit (динаміки, мікрофони, веб-камери і звукова панель). Крім того, він відправляє вміст з камери і спикерфона на пристрій Button.

Радіотехнологія	Смуги радіочастот Radio	Максимальна потужність випромінювання
WLAN 802.11b/g/n	2400 – 2483,5 МГц	20 дБм ЕІВП
WLAN 802.11a/n/ac	5150 – 5850 МГц	20 дБм ЕІВП
IEEE 802.15.1 BT LE 4.1	2400 – 2483,5 МГц	20 дБм ЕІВП

Щоб дізнатися, який регіональний варіант необхідно використовувати у вашій країні, зверніться до місцевого торгового представника. (www.barco.com/en/support)

Регіональну версію C5011S неможливо змінити. Це означає, що продукт не можна буде використовувати в іншому регіоні.

B.6 Product compliance Russia

Подтверждение соответствия Минкомсвязи России

Декларация соответствия №Д-ИВРД-6147 от 09.07.2019 года, действительна до 09.07.2025 года, зарегистрирована в Федеральном агентстве связи 17.07.2019 года

Декларация соответствия №Д-ИВРД-6148 от 09.07.2019 года, действительна до 09.07.2025 года, зарегистрирована в Федеральном агентстве связи 17.07.2019 года

EAC Certification



Image B-1

Подтверждение соответствия Минкомсвязи России: Декларация соответствия Д-ИВРД-5756 от хх.уу. zzzz года, действительна до хх.уу. zzzz года, зарегистрирована в Федеральном агентстве связи хх.уу. zzzz года

B.7 Product compliance Turkey

Turkey RoHS compliance



Türkiye Cumhuriyeti: AEEE Yönetmeliğine Uygundur.
[Republic of Turkey: In conformity with the WEEE Regulation]

B.8 Product compliance US

Federal Communication Commission Interference Statement

You are cautioned that changes or modifications not expressly approved by the part responsible for compliance could void the user's authority to operate the equipment.

This equipment has been tested and found to comply with the limits for a Class B digital device, pursuant to Part 15 of the FCC rules. These limits are designed to provide reasonable protection against harmful interference in a residential installation. This equipment generates, uses and can radiate radio frequency energy and, if not installed and used in accordance with the instructions, may cause harmful interference to radio communications. However, there is no guarantee that interference will not occur in a particular installation.

If this equipment does cause harmful interference to radio or television reception, which can be determined by turning the equipment off and on, the user is encouraged to try to correct the interference by one or more of the following measures:

- Reorient or relocate the receiving antenna.
- Increase the separation between the equipment and receiver.
- Connect the equipment into an outlet on a circuit different from that to which the receiver is connected.
- Consult the dealer or an experienced radio/TV technician for help.

You may also find helpful the following booklet, prepared by the FCC: "How to Identify and Resolve Radio-TV Interference Problems." This booklet is available from the U.S. Government Printing Office, Washington D.C. 20402.

Changes and Modifications not expressly approved by the manufacturer or registrant of this equipment can void your authority to operate this equipment under Federal Communications Commissions rules.

In order to maintain compliance with FCC regulations shielded cables must be used with this equipment. Operation with non-approved equipment or unshielded cables is likely to result in interference to radio & television reception.

This device complies with Part 15 of the FCC Rules. Operation is subject to the following two conditions: (1) this device may not cause harmful interference, and (2) this device must accept any interference received, including interference that may cause undesired operation.

FCC RF Radiation Exposure Statement: This device is capable of operating in 802.11a mode. For 802.11a devices operating in the frequency range of 5.15 - 5.25 GHz, they are restricted for indoor operations to reduce any potential harmful interference for Mobile Satellite Services (MSS) in the US. WIFI Access Points that are capable of allowing your device to operate in 802.11a mode (5.15 - 5.25 GHz band) are optimized for indoor use only. If your WIFI network is capable of operating in this mode, please restrict your WIFI use indoors to not violate federal regulations to protect Mobile Satellite Services.

1. This Transmitter must not be co-located or operating in conjunction with any other antenna or transmitter.
2. This equipment complies with RF radiation exposure limits set forth for an uncontrolled environment. This equipment should be installed and operated with a minimum distance of 20 cm between the radiator and your body.

Base Unit FCC ID: PPQ-WCBN814A

Base Unit Contains FCC ID: PPQ-WCBN814A

Button FCC ID (model R9861600D01C): 2AAED-R9861600D01

Button FCC ID (model CSBTN004): 2AAED-CSBTN004

ClickShare Button 2AAED-R9861600D01 has been tested and meets the FCC RF exposure guidelines. The maximum SAR value reported is 1.19 W/kg.

ClickShare Button 2AAED-CSBTN004 has been tested and meets the FCC RF exposure guidelines. The maximum SAR value reported is 0.47 W/kg.

ClickShare Button 2AAED-R9861600D01 or 2AAED-CSBTN004 should be installed and operated with a minimum distance of 5 mm between the radiator and your body.

FCC responsible: Barco Inc., 3059 Premiere Parkway Suite 400, 30097 Duluth GA, United States, Tel: +1 678 475 8000

For country code selection usage (WLAN devices) :

Note: The country code selection is for non-US model only and is not available to all US model. Per FCC regulation, all WiFi product marketed in US must fixed to US operation channels only.

California, USA

The button cell battery may contain perchlorate material and requires special handling when recycled or disposed of in California.

For further information please visit: <https://dtsc.ca.gov/perchlorate/>

B.9 Product compliance Canada

Canada, Industry Canada (IC) Notices

This device complies with Industry Canada licence-exempt RSS standard (s). Operation is subject to the following two conditions: (1) this device may not cause interference, and (2) this device must accept any interference, including interference that may cause undesired operation of the device.

Radio Frequency (RF) Exposure Information

The radiated output power of the Barco Wireless Device is below the Industry Canada (IC) radio frequency exposure limits. The Barco Wireless Device should be used in such a manner such that the potential for human contact during normal operation is minimized.

Caution: Exposure to Radio Frequency Radiation.

1. To comply with the Canadian RF exposure compliance requirements, this device and its antenna must not be co-located or operating in conjunction with any other antenna or transmitter.
2. To comply with RSS 102 RF exposure compliance requirements, a separation distance of at least 20 cm must be maintained between the antenna of this device and all persons.

Base Unit Contains IC: 4491A-WCBN814A

Button IC (model R9861600D01C): 21559-R9861600D01

Button IC (model CSBTN004): 21559-CSBTN004

ClickShare Button 21559-R9861600D01 has been tested and meets the IC RF exposure guidelines. The maximum SAR value reported is 1.19 W/kg.

ClickShare Button 21559-CSBTN004 has been tested and meets the IC RF exposure guidelines. The maximum SAR value reported is 0.47 W/kg.

ClickShare Button 21559-R9861600D01 or 21559-CSBTN004 should be installed and operated with a minimum distance of 5 mm between the radiator and your body.

IC Antenna statement

Under Industry Canada regulations, this radio transmitter may only operate using an antenna of a type and maximum (or lesser) gain approved for the transmitter by Industry Canada. To reduce potential radio interference to other users, the antenna type and its gain should be so chosen that the equivalent isotropically radiated power (e.i.r.p.) is not more than that necessary for successful communication.

This radio transmitter 4491A-WCBN814A has been approved by Industry Canada to operate with the antenna types listed below with the maximum permissible gain and required antenna impedance for each antenna type indicated. Antenna types not included in this list, having a gain greater than the maximum gain indicated for that type, are strictly prohibited for use with this device.

Indoor use only warning

Operation in the band 5150 MHz - 5250 MHz is only for indoor use to reduce the potential for harmful interference to co-channel mobile satellite systems.

Certification information (SAR)

This device is also designed to meet the requirements for exposure to radio waves established by the Industry Canada.

The SAR limit adopted by Canada is 1.6 W/kg averaged over one gram of tissue. The highest SAR value reported to the IC for this device type complies with this limit.

The highest SAR value reported to the IC for this device type when using in portable exposure conditions is 1.14W/kg.

Canada, avis d'Industry Canada (IC)

Le présent appareil est conforme aux CNR d'Industrie Canada applicables aux appareils radio exempts de licence. L'exploitation est autorisée aux deux conditions suivantes: (1) l'appareil ne doit pas produire de brouillage, et (2) l'utilisateur de l'appareil doit accepter tout brouillage radioélectrique subi, même si le brouillage est susceptible d'en compromettre le fonctionnement.

Informations concernant l'exposition aux fréquences radio (RF)

La puissance de sortie émise par l'appareil de sans fil Barco est inférieure à la limite d'exposition aux fréquences radio d'Industry Canada (IC). Utilisez l'appareil de sans fil Barco de façon à minimiser les contacts humains lors du fonctionnement normal.

Avertissement: L'exposition aux rayonnements fréquences radio

1. Pour se conformer aux exigences de conformité RF canadienne l'exposition, cet appareil et son antenne ne doivent pas être co-localisés ou fonctionnant en conjonction avec une autre antenne ou transmetteur.
2. Pour se conformer aux exigences de conformité CNR 102 RF exposition, une distance de séparation d'au moins 20 cm doit être maintenue entre l'antenne de cet appareil et toutes les personnes.

Base Unit contient IC: 4491A-WCBN814A

IC Button (modèle R9861600D01C): 21559-R9861600D01

IC Button (modèle CSBTN004): 21559-CSBTN004

ClickShare Button 21559-R9861600D01 a été testé et répond aux directives d'exposition RF de la IC. La valeur SAR maximale rapportée est de 1,19 W/kg.

ClickShare Button 21559-CSBTN004 a été testé et répond aux directives d'exposition RF de la IC. La valeur SAR maximale rapportée est de 0,47 W/kg.

ClickShare Button 21559-R9861600D01 ou 21559-CSBTN004 ; devrait être installé et utilisé avec une distance minimale de 5 mm entre le radiateur et votre corps.

Déclaration d'antenne d'Industrie Canada (IC)

Conformément à la réglementation d'Industrie Canada, le présent émetteur radio peut fonctionner avec une antenne d'un type et d'un gain maximal (ou inférieur) approuvé pour l'émetteur par Industrie Canada. Dans le but de réduire les risques de brouillage radioélectrique à l'intention des autres utilisateurs, il faut choisir le type d'antenne et son gain de sorte que la puissance isotrope rayonnée équivalente (p.i.r.e.) ne dépasse pas l'intensité nécessaire à l'établissement d'une communication satisfaisante.

Le présent émetteur radio 4491A-WCBN814A a été approuvé par Industrie Canada pour fonctionner avec les types d'antenne énumérés ci-dessous et ayant un gain admissible maximal et l'impédance requise pour chaque type d'antenne. Les types d'antenne non inclus dans cette liste, ou dont le gain est supérieur au gain maximal indiqué, sont strictement interdits pour l'exploitation de l'émetteur.

Utilisation à l'intérieur seulement

La bande 5150 MHz - 5250 MHz est réservés uniquement pour une utilisation à l'intérieur afin de réduire les risques de brouillage préjudiciable aux systèmes de satellites mobiles utilisant les mêmes canaux.

Informations de certification (DAS)

Cet appareil est également conçu pour satisfaire aux exigences concernant l'exposition aux ondes radioélectriques établies par Industrie Canada.

Le seuil du DAS adopté par le Canada est de 1.6 W/kg pour 1g de tissu. La plus grande valeur de DAS signalée à IC pour ce type d'appareil ne dépasse pas ce seuil.

La valeur maximale de DAS signalée à IC pour ce type d'appareil lors du test dans des conditions d'exposition portative est de 1.14W/kg.

B.10 Product compliance Brazil

Visão geral da conformidade ANATEL

Este equipamento não (C5011S; R9861600D01C; CSBTN004) tem direito à proteção contra interferência prejudicial e não pode causar interferência em sistemas devidamente autorizados. O uso deste equipamento é restrito a ambientes fechados e é proibido em plataformas petrolíferas, veículos automotores, trens, embarcações e no interior de aeronaves abaixo de 3.048 metros (10.000 pés).

Este equipamento não possui direito à proteção contra interferência prejudicial e não pode causar interferência em sistemas devidamente autorizados. Para mais informações, consulte o site da ANATEL: www.gov.br/anatel

B.11 Product compliance Mexico

Cumplimiento

La operación de este equipo está sujeta a las siguientes dos condiciones: (1) es posible que este equipo o dispositivo no cause interferencia perjudicial y (2) este equipo o dispositivo debe aceptar cualquier interferencia, incluyendo la que pueda causar su operación no deseada.

NOM certification



IFETEL ID: RCPBACxxx-xxxx

B.12 Product compliance Korea

KCC Statement

기본 장치 기기명칭: 특정소출력무선기기(무선데이터통신시스템용 무선기기)

인증자상호: Barco N.V.

모델명: C5011S

인증번호: R-C-BVY-R9861622

제조연월: 202x

제조사/제조국: Barco NV/중국

본 기기와 20 cm 이상 떨어져서 사용하시기 바랍니다

이 기기는 가정용(B급) 전자파적합기기임

버튼 기기명칭: 특정소출력무선기기(무선데이터통신시스템용 무선기기)

인증자상호: Barco N.V.

모델명: R9861600D01C

인증번호: R-C-BVY-R9861600D01

제조연월: 2019

제조사/제조국: Barco NV/중국

버튼 기기명칭: 특정소출력무선기기(무선데이터통신시스템용 무선기기)

인증자상호: Barco N.V.

모델명: CSBTN004

인증번호: R-C-BVY-CSBTN004

제조연월: 2022

제조사/제조국: Barco NV/중국

모델명

R9861600D01C

CSBTN004

RF 경고: 해당 무선설비가 전파혼신 가능성이 있으므로 인명안전과 관련된 서비스는 할 수 없습니다.

EMC 경고 :

이 기기는 업무용 환경에서 사용할 목적으로 적합성평가를 받은 기기로서

가정용 환경에서 사용하는 경우 전파간섭의 우려가 있습니다.

KCC certification



R-R-BVY-CSBTN004

R-C-BVY-R9861600D01

WCBN814A: R-C-LTO-WCBN814A

C5011S: R-R-BVY-R9861611

B.13 Product compliance Taiwan

根據NCC低功率電波輻射性電機管理辦法 規定

第十二條 經型式認證合格之低功率射頻電機，非經許可，公司、商號或使用者均不得擅自變更頻率、加大功率或變更原設計之特性及功能。

第十四條 低功率射頻電機之使用不得影響飛航安全及干擾合法通信；經發現有干擾現象時，應立即停用，並改善至無干擾時方得繼續使用。

前項合法通信，指依電信法規定作業之無線電通信。

低功率射頻電機須忍受合法通信或工業、科學及醫療用電波輻射性電機設備之干擾。

底座 CCAM19LP0281T1

按鈕 CCAM19LP0900T0

警告

應避免影響附近雷達系統之操作。

高增益指向性天線只得應用於固定式點對點系統。

電磁波曝露量MPE標準值1mW/cm²，送測產品實測值為：0.082 mW/cm²，建議使用時至少距離人體20公分

Taiwan



For better environmental protection, waste batteries should be collected separately for recycling or special disposal.

廢電池請回收

限用物質含有情況標示聲明書 (Declaration of the Presence Condition of the Restricted Substances Marking) – Taiwan RoHS compliance

設備名稱： 影音共享控制中心， 型號 (型式)： C5011S						
Equipment name: wireless presentation system, Type designation: C5011S						
	限用物質及其化學符號 Restricted substances and its chemical symbols					
單元 Unit	鉛 Lead (Pb)	汞 Mercury (Hg)	鎘 Cadmium (Cd)	六價鉻 Hexavalent chromium (Cr6+)	多溴聯苯 Poly- brominated biphenyl (PBB)	多溴二苯醚 Poly- brominated diphenyl ethers (PBDE)
電路板 Printed Circuit Assemblies	—	○	○	○	○	○
電 (線) 纜 Cables	—	○	○	○	○	○
機箱 Chassis	○	○	○	○	○	○
電源供應器 Power Supply Unit	—	○	○	○	○	○

按鍵 Button	—	○	○	○	○	○
--------------	---	---	---	---	---	---

備考1. “超出0.1 wt %”及“超出0.01 wt %”係指限用物質之百分比含量超出百分比含量基準值。
Note 1: “Exceeding 0.1 wt %” and “exceeding 0.01 wt %” indicate that the percentage content of the restricted substance exceeds the reference percentage value of presence condition.

備考2. “○”係指該項限用物質之百分比含量未超出百分比含量基準值。
Note 2: “○” indicates that the percentage content of the restricted substance does not exceed the percentage of reference value of presence.

備考3. “—”係指該項限用物質為排除項目。
Note 3: The “—” indicates that the restricted substance corresponds to the exemption.

B.14 Product compliance China

SRRC certification

型号核准代码以实物铭牌显示

产品中有害物质的名称及含有信息表 (China RoHS compliance)

根据中华人民共和国《电器电子产品有害物质限制使用管理办法》规定，以下部分列出了Barco产品中可能包含的有毒和/或有害物质的名称和含量。

部件名称 Component name	有害物质 Hazardous Substances or Elements									
	铅 (Pb)	汞 (Hg)	镉 (Cd)	六价铬 (Cr ⁶⁺)	多溴联苯 (PBB)	多溴二苯醚 (PBDE)	邻苯二甲酸二正丁酯 (DBP)	邻苯二甲酸二异丁酯 (DIBP)	邻苯二甲酸丁基苄酯 (BBP)	邻苯二甲酸二(2-乙基)己酯 (DEHP)
印制电路配件 Printed Circuit Assemblies	X	○	○	○	○	○	○	○	○	○
电(线)缆 Cables	X	○	○	○	○	○	○	○	○	○
底架 Chassis	○	○	○	○	○	○	○	○	○	○
电源供应器 Power Supply Unit	X	○	○	○	○	○	○	○	○	○
文件说明书 Paper Manuals	○	○	○	○	○	○	○	○	○	○
按鍵 Button	X	○	○	○	○	○	○	○	○	○

注1:
○: 表示该有害物质在该部件所有均质材料中的含量均不超出电器电子产品有害物质限制使用国家标准要求。
X: 表示该有害物质至少在该部件的某一均质材料中含量超出电器电子产品有害物质限制使用国家标准要求。

注2:
以上未列出的部件，表明其有害物质含量均不超出电器电子产品有害物质限制使用国家标准要求。



B.15 Product compliance Thailand

NBTC certification

เครื่องโทรคมนาคมและอุปกรณ์ที่มีความสอดคล้องตามมาตรฐานหรือข้อกำหนดทางเทคนิคของ กสทช.



Image B-2

B.16 Product compliance India

Plastic waste management

- **Importer EPR Regn. No.:** IM-05-000-12-ADPPA7994P-23 (under India PWM, 2016 as amended)
- **Thickness:** ≥0.05 mm
- **Category:** 04
- **Company:** CEECO Technologies Pvt Ltd, Inflow Technologies Pvt Ltd

B.17 Product privacy statement

About

Learn more about Barco's Product Privacy Statement:

<https://www.barco.com/en/about/trust-center/product-privacy-statement>.

Which data is captured and why

Following data¹ is captured for general secure operation of the product.

- IP addresses
- User ID information
- Date and time information
- Mobile network information
- Network configuration information
- Device identification information
- Device operational conditions
- Device environmental conditions
- Device performance metric
- Device configuration information
 - Resolution
 - Brightness

1. Only if applicable for the product type and model.

- Device input configuration
 - Active inputs
 - Input resolution

Data retention mechanism

An administrator should modify or delete a user (upon user request, or when the user does not work for the company anymore), either via the Users feature, or via a factory reset executed as administrator.

Logs may contain user names and IP addresses and are subject to the retention policy, but cannot be deleted by the user. The user can send a request to dataprotection@barco.com.

B.18 Trademark notice

HDMI™

The terms HDMI, HDMI High-Definition Multimedia Interface, HDMI trade dress and the HDMI Logos are trademarks or registered trademarks of HDMI Licensing Administrator, Inc.

USB Type-C™

USB Type-C and USB-C are a registered trademarks of USB Implementers Forum

Kensington™

The Kensington logo is a registered trademark of ACCO Brands Corporation.



All other trademarks and registered trademarks are trademarks or registered trademarks of their respective holders. In this manual, ™ and ® marks are not specified.

License information

C

C.1	End user license	68
C.2	ClickShare product end user license	72
C.3	Open source software	73

C.1 End user license

Barco end user license agreement

By accepting these terms (through tick box or other mechanism designed to acknowledge agreement to the terms of an electronic copy of this License Agreement), or by installing, downloading, accessing, or otherwise copying or using all or any portion of the Software (as defined below), (i) you accept this License Agreement on behalf of the entity for which you are authorized to act (e.g., your employer) and you agree to act in a manner consistent with this License Agreement (or, if there is no such entity for which you are authorized to act, you accept this License Agreement on behalf of yourself as an individual and acknowledge that you are legally bound by this Agreement), and (ii) you represent and warrant that you are duly empowered by the end user in case you act on behalf of such entity.

These terms apply to your use of the Software as of and for the original Term of your license. When you renew or purchase an additional license, the then current version of this License Agreement shall apply and will remain unchanged during the term of that license and/or in respect of such changed elements. The other contract documents (Product Specific EULA; Maintenance and Support Agreement, if and when provided alongside with this document) applies in addition to these terms and constitute the entire License Agreement. You acknowledge that an electronic copy of this Agreement shall have the same proving value as a hard copy signed by the parties.

If you are unwilling to accept this License Agreement on these terms, or you do not have the right, power and authority to act on behalf of and bind such entity (or yourself as an individual if there is no such entity), DO NOT SELECT THE "I ACCEPT" BUTTON OR OTHERWISE CLICK ON ANY BUTTON OR OTHER MECHANISM DESIGNED TO ACKNOWLEDGE AGREEMENT, AND DO NOT INSTALL, DOWNLOAD, ACCESS, OR OTHERWISE COPY OR USE ALL OR ANY PORTION OF THE SOFTWARE.

1. Definitions

- **Affiliate:** means any corporation or other entity directly or indirectly, controlling, controlled by or under common control with such corporation or entity. For the purpose of the above, "control" shall mean (i) the ownership or control, directly or indirectly, of fifty percent (50%) or more of the equity capital or the shares or voting rights in the corporation or other entity in question or (ii) the control of the composition of the board of directors of the corporation or other entity in question.
- **Barco:** means Barco NV (company number 0473.191.041) with company address at Beneluxpark 21, 8500 Kortrijk, Belgium, or its designated Affiliate licensing to you the proprietary software which is the subject matter of this Agreement.
- **Documentation:** means all technical, reference and installation manuals, user guides, published performance specifications and other written documentation provided by Barco generally to its licensees with respect to the Software, along with any modifications and updates thereto.
- **DRM:** means Barco's digital rights management platform used to provide access to and access conditions of the Software.
- **License agreement:** means this Barco End User License Agreement (EULA), incorporating the terms of the Product Specific EULA, and any modifications thereof as set out herein.
- **Software:** means the Barco proprietary software which is being licensed hereunder, released in object code only.
- **Term:** means the period set out in article 9.1 hereof.
- **Product specific EULA:** means the supplemental software terms applicable.
- **You:** means the entity on behalf of which these terms are accepted, and any of its representatives having access to the Software.

2. License grant

1. **License scope:** Subject to compliance with all license terms and payment of applicable fees, Barco grants you a limited, non-exclusive, non-assignable, non-transferable user license (without the right to grant sublicenses). Save for the Product Specific EULA or any broader license terms confirmed through the DRM tool, (i) the license under this License Agreement applies to one (1) copy of the Software to be used on one single computing device and (ii) installation on a computing device that may be concurrently accessed by more than one user shall not constitute a permitted use and a separate license is required for each active user connected to a computing device on which the Software is being used
2. **License type:** The applicable license type, and your rights in time, deployment and usage, are further detailed in the Product Specific EULA (in the absence of which the scope shall be as set in article 1 hereof).

3. License restrictions:

- **Intended use:** You agree to use the Software solely as permitted by this License Agreement (and any Product Specific EULA made part of it) and in a matter consistent with its design and Documentation.
 - **No transfer (license agreement):** You agree not to transfer, assign or sublicense your license rights to any other person or entity, unless Barco's prior written consent is obtained (which consent shall be reasonably given, but may come with a fee).
 - **No transfer (software):** If you deactivate or uninstall the Software from the computer device on which it was originally installed, this will terminate this License Agreement unless otherwise and specifically approved by Barco. You agree not to use the Software in association with other hardware or software that allows to pool connections, reroute information, reduce the number of devices or users that directly access or use the Software, or reduce the number of devices or users the Software directly manages (sometimes referred to as "multiplexing" or "pooling") or otherwise attempt to reduce the number of licenses of any type that you need.
 - **Authorized users:** The use of the Software is restricted to persons within your organization, or any third party representatives operating under your responsibility and control, provided any such persons have accepted the terms of this License Agreement. You agree not to use or permit the Software to be used to perform services for third parties, whether on a service bureau or time sharing basis or otherwise, without the prior written authorization of Barco. You shall not lease, rent, or otherwise transfer or grant a security or other interest in the Software.
 - **No modifications:** You shall not make error corrections to or otherwise modify or adapt the Software or create derivative works based upon the Software, or permit third parties to do the same.
 - **No reverse engineering:** You agree not to reverse engineer or decompile, decrypt, disassemble or otherwise reduce the Software to human-readable form, except to the extent otherwise expressly permitted under applicable law notwithstanding this restriction, or except to the extent Barco is legally required to permit such specific activity pursuant to any applicable open source license.
 - **Code required to ensure interoperability:** To the extent required by law, and at your written request, Barco shall provide you with the interface information needed to achieve interoperability between the Software and another independently created program used by you, on payment of Barco's applicable fee (if any). You shall observe strict obligations of confidentiality with respect to such information and shall use such information in compliance with terms and conditions which Barco makes applicable.
 - **No unbundling:** The Software may include various applications and components, may support multiple platforms and languages, and may be provided on multiple media or in multiple copies. Nonetheless, the Software is designed and provided to you as a single product to be used as a single product on devices as permitted herein. You agree not to unbundle the component parts of the Software for use on different computer devices.
 - **Territory:** You agree to use the Software solely in the territory or region where you obtained the Software from Barco or its authorized reseller or as otherwise stated in the Documentation. Any export if permitted shall comply with any applicable (export) laws and regulations.
4. **Your infrastructure:** You remain responsible to procure and maintain hardware, operating system, network and other infrastructure (the "Infrastructure") required to operate the Software and to keep such Infrastructure functioning and virus-free. You acknowledge that the Software is a complex computer software application, and that the performance thereof may vary depending hardware platform, software interactions and configuration. You acknowledge that the Software is not designed and produced specifically to meet your specific requirements and expectations and the selection of the Software by you is entirely your own choice and decision.

3. Ownership and intellectual property rights

1. **Ownership:** Any Software is licensed, not sold to you, on a non-exclusive basis for use only under the terms of this License Agreement, and Barco and its suppliers reserve all rights not expressly granted to you. You may own the carrier on which the Software is provided, but the Software is owned and copyrighted by Barco or by third party suppliers. Your license confers no title or ownership and is not a sale of any rights in the Software or its Documentation.
2. **Third party materials:** The Software may contain or require the use of certain third party technology (whether proprietary or open source software), identified by Barco in the Documentation, readme file, third-party click-accept, on www.barco.com or elsewhere (the "Identified Components"). Identified Components may be subject to additional and/ or different terms and you agree that the Identified Components are licensed under the terms, disclaimers and warranties of their respective licenses which in the forthcoming case shall override the provisions of this License Agreement.
3. **Source code access:** To the extent required under third party (open source) license terms, and for a period of 36 months following your acceptance of this License Agreement, Barco shall provide access to the source code controlled by a third party (open source) license, via email or download link. If the relevant

license terms require so, you may require Barco (attn. its legal department, at the address stated above) to obtain such code on tangible medium against payment of the cost of media, shipping and handling.

4. **Copyright:** The Software is protected by national and international laws and treaty provisions. Copyright on the Software components belongs to the respective initial copyright holder, each additional contributor and/or their respective assignee(s), as may be identified in the Software Documentation, source code, README file, or otherwise. You shall not remove or obscure or otherwise alter the respective copyrights.
5. **Trademarks:** Brand and product names mentioned in relation to the Software may be trademarks, registered trademarks or copyrights of their respective (third party) holders. All such brand and product names mentioned in relation to the Software serve as comments or examples and are not to be understood as advertising for the products or their manufacturers.
6. **Trade Secrets:** You agree not to disclose, provide or otherwise make available trade secrets contained within the Software and Documentation in any form to any third party without the prior written consent of Barco. You shall implement reasonable security measures to protect such trade secrets.

4. Support

1. **Principle:** Barco is under no obligation to provide support in respect of the Software, except as included in a Product Specific EULA and/or the extent you have entered into a separate maintenance agreement. Any unauthorized use of the Software may prohibit Barco from providing such support.
2. **Support policy:** Barco may provide to you maintenance releases to address bugs or security issues in the Software and you agree to install the same. Any other updates or upgrades can be obtained under the terms of a separate software maintenance which is being offered to you. You may have a right to downgrade your licensed Software application to (only) such earlier version of the same Software application as agreed by Barco in the forthcoming case.

Additional functionality may be licensed to you with and subject to additional or different terms.

5. Warranty

EXCEPT FOR THE LIMITED WARRANTY THAT MAY APPLY AS PER THE PRODUCT SPECIFIC EULA, YOU UNDERSTAND THAT THE SOFTWARE IS BEING PROVIDED TO YOU "AS IS". BARCO DOES NOT MAKE NOR INTENDS TO MAKE ANY WARRANTIES OR REPRESENTATIONS, EXPRESS OR IMPLIED AND SPECIFICALLY DISCLAIMS ALL IMPLIED WARRANTIES OF MERCHANTABILITY, FITNESS FOR A PARTICULAR PURPOSE AND NON-INFRINGEMENT OF INTELLECTUAL PROPERTY AND DOES NOT WARRANT THAT THE SOFTWARE WILL BE FREE FROM ERRORS OR THAT YOU WILL BE ABLE TO OPERATE THE SOFTWARE WITHOUT INTERRUPTIONS OR THAT SUCH ERRORS WILL BE CORRECTED BY BARCO. EXCEPT FOR ANY MAINTENANCE AND SUPPORT OBLIGATIONS SEPARATELY AGREED, YOU ARE SOLELY RESPONSIBLE FOR ALL COSTS AND EXPENSES ASSOCIATED WITH RECTIFICATION, REPAIR OR DAMAGE CAUSED BY SUCH ERRORS. IN THE FORTHCOMING CASE, THE WARRANTY DISCLAIMER FOUND IN APPLICABLE OPEN SOURCE LICENSES SHALL OVERRIDE THE PROVISIONS OF THIS LICENSE AGREEMENT.

6. Compliance and enforcement

1. **Reporting and audit:** In addition to good practice record-keeping obligations, you agree to report the use of the Software and relating billing metrics in the DRM or otherwise as agreed. You grant to Barco and its designated auditors, at Barco's expenses, the right to verify your Software deployments and to examine your books, records and accounts during your normal business hours so as to verify your compliance with the License Agreement. In the event such audit discloses non-compliance with your payment obligations hereunder, you shall promptly pay to Barco the appropriate license fees plus the reasonable cost of conducting the audit.
2. **Enforcement:** Barco shall notify the then known user through the DRM (failing of which, otherwise in writing) of a substantial non-compliance, based on the triggers as per the Product Specific EULA. The non-compliance may result in an immediate or graduate denial of service (i.e. termination of the rights granted under the License Agreement), in part or in full, all based on the level of severity of the non-compliance [as per the Product Specific EULA].
3. **Indemnification:** YOU HEREBY AGREE TO INDEMNIFY, DEFEND AND HOLD HARMLESS BARCO AND BARCO'S AFFILIATES FROM AND AGAINST ANY AND ALL ACTIONS, PROCEEDINGS, LIABILITY, LOSS, DAMAGES, FEES AND COSTS (INCLUDING ATTORNEY FEES), AND OTHER EXPENSES INCURRED OR SUFFERED BY BARCO ARISING OUT OF OR IN CONNECTION WITH ANY BREACH BY YOU OF THE TERMS OF THIS SOFTWARE LICENSE.

7. Limitation of liability

TO THE MAXIMUM EXTENT PERMITTED BY LAW, BARCO ACCEPTS NO LIABILITY FOR ANY DAMAGES, LOSSES OR CLAIMS YOU OR ANY THIRD PARTY MAY SUFFER AS A RESULT OF YOUR USE OF THE SOFTWARE. IN JURISDICTIONS WHERE BARCO'S LIABILITY CANNOT BE EXCLUDED, BARCO'S LIABILITY FOR DIRECT DAMAGES SHALL BE LIMITED TO AN AMOUNT OF 250 EURO IN THE AGREGATE (OR TO THE MAXIMUM EXTENT PERMITTED BY LAW WHERE NO FURTHER EXCLUSION IS LEGALLY ALLOWED).

TO THE MAXIMUM EXTENT PERMITTED BY LAW, IN NO EVENT WILL BARCO BE LIABLE FOR ANY INDIRECT, SPECIAL, PUNITIVE, INCIDENTAL OR CONSEQUENTIAL LOSS OR DAMAGES OF ANY KIND WHICH MAY ARISE OUT OF OR IN CONNECTION WITH THE SOFTWARE, THIS SOFTWARE LICENSE OR THE PERFORMANCE OR PURPORTED PERFORMANCE OF OR FAILURE IN THE PERFORMANCE OF BARCO'S OBLIGATIONS UNDER THIS SOFTWARE LICENSE OR FOR ANY ECONOMIC LOSS, LOSS OF BUSINESS, CONTRACTS, DATA, GOODWILL, PROFITS, TURNOVER, REVENUE, REPUTATION OR ANY LOSS ARISING FROM WORK STOPPAGE, COMPUTER FAILURE OR MALFUNCTION OF THE SOFTWARE AND ANY AND ALL OTHER COMMERCIAL DAMAGES OR LOSSES WHICH MAY ARISE IN RESPECT OF USE OF THE SOFTWARE, EVEN IF BARCO HAS BEEN ADVISED OF THE POSSIBILITY OF THEIR OCCURRENCE.

8. Confidentiality

1. **Confidential Information:** You will be receiving information which is proprietary and confidential to Barco during the negotiation and Term of this License Agreement. "Confidential Information" shall include (i) the underlying logic, source code and concepts of the Software or other trade secrets (the access to which is strictly limited as expressly set out herein), (ii) any information designated as confidential by Barco or which has the necessary quality of confidence about it and (iii) any license key provided by Barco to you hereunder.
2. **Non-Disclosure:** You agree not to divulge any Confidential Information to any persons without Barco's prior written consent provided that this article 8 shall not extend to information which was rightfully in your possession prior to the commencement of the negotiations leading to this License Agreement, which is already public knowledge or becomes so at a future date (otherwise than as a result of a breach of this article 8), to the extent it is required to be disclosed by law or which is trivial or obvious. You agree not to use any Confidential Information except for the authorized purpose hereunder. The foregoing obligations as to confidentiality shall survive the Term of this License Agreement.

9. Term and termination

1. **Term:** The duration of this License Agreement will be from the date of your acceptance (as set forth above) of the Software (whereby you acknowledge that use of the Software implies acceptance), until you deactivate the Software, discontinue the use of the device on which the Software was first installed for its intended use or the expiration of the limited time period set out in the Product Specific EULA, whichever comes first.
2. **Termination:** You may terminate this License Agreement at any time by destroying all copies of the Software then in your possession and returning all Documentation and associated materials, to Barco or the appointed Barco reseller that sold or provided these to you. Barco may terminate this License Agreement, immediately or gradually in accordance with article 6 hereof, by informing you at any time if any user is in breach of any of the License Agreement's terms.
3. **Consequences of termination:** All rights associated with the use of the Software and the acquisition of updates and upgrades cease once the contract is terminated or expires. Cancelling your license will stop recurring fees going forward, but will not retroactively refund current or past payments.

10. Other relevant terms

1. **Data Protection:** Barco may, without restriction, save, process, use and reuse any data obtained in connection with the sales or supply of the Services. Barco shall take suitable technical and organizational measures to protect personal data received against loss and unlawful processing.
2. **Functional Information:** Via the Software, Barco may gather technical, aggregated and/or statistical information about (i) the functioning and the functionality of the products which are connected through the Software, and/or (ii) as provided by You or generated by Your use of the Software ("Functional Information"). Barco and its service providers may process and use such Functional Information for analytics purposes, for developing and improving products and services, offering products and services to Your organization, all based on the legitimate interest of Barco of evaluating the market, assessing and

improving its products and conducting research and development. This Section shall survive the term of this Agreement.

3. **Return of data:** Upon Your request made within 60 days after the termination or expiration of this Agreement, Barco will make User Data available to You for export or download as provided in the Documentation. After such 60-day period, Barco shall have no obligation to maintain or provide any User Data, and as provided in the Documentation will thereafter delete or destroy all copies of User Data in Barco's systems or otherwise in Barco's possession or control, unless legally prohibited.

11. Final Clauses

1. **Entire agreement:** This License Agreement is the only understanding and agreement between you and Barco for use of the Software. This License Agreement supersedes all other communications, understandings or agreements we had prior to this License Agreement (with the exception of any continuing confidentiality agreement).
2. **Notices:** Notices can be validly delivered to the parties' last known address.
3. **Severability:** This License Agreement shall not be altered, amended or varied. If any provision of this License Agreement is determined to be illegal, void or unenforceable, or if any court of competent jurisdiction in any final decision so determines, this License Agreement shall continue in full force save that such provision shall be deemed to be deleted with effect from the date of such decision, or such earlier date, and shall be replaced by a provision which is acceptable by law and which embodies the intention of this License Agreement as close as possible.
4. **Export:** You acknowledge that this Software may be subject to U.S. or other governments Export Jurisdiction. You agree to comply with all applicable international and national laws that apply to the Software, including the U.S. Export Administration Regulations, as well as end-user, end-use, and destination restrictions issued by the U.S. or other governments.
5. **Survival:** The provisions of articles 3, 5, 6, 7 and 8 will survive the termination of this License Agreement, howsoever caused, but this will not imply or create any continued right to use the Software after termination of this License Agreement.
6. **Assignment:** Barco shall be entitled to sub-contract all or any of Barco's obligations hereunder to a third party and/or any of Barco's Affiliates.
7. **Law and Jurisdiction:** The construction, validity and performance of this License Agreement shall be governed in all respects by the laws of Belgium, without recourse to its conflict of law principles. All disputes arising in any way out of or affecting this License Agreement shall be subject to the exclusive jurisdiction of the courts of Kortrijk, without prejudice to enforcement of any judgment or order thereof in any other jurisdiction. The United Nations Convention on Contracts for the International Sale of Goods (the "Convention") shall not apply to this License Agreement, however, if the Convention is deemed by a court of competent jurisdiction to apply to this License Agreement, Barco shall not be liable for any claimed non-conformance of the Software under Article 35(2) of the Convention.

YOU HEREBY ACKNOWLEDGE TO HAVE READ, UNDERSTOOD AND ACCEPTED TO BE BOUND BY ALL THE TERMS AND CONDITIONS OF THIS LICENCE AGREEMENT AS INDICATED ABOVE

C.2 ClickShare product end user license

Barco ClickShare Product Specific End User License Agreement²

THIS PRODUCT SPECIFIC USER LICENSE AGREEMENT (EULA) TOGETHER WITH THE BARCO GENERAL EULA ATTACHED HERETO SET OUT THE TERMS OF USE OF THE SOFTWARE.

PLEASE READ THIS DOCUMENT CAREFULLY BEFORE OPENING OR DOWNLOADING AND USING THE SOFTWARE.

DO NOT ACCEPT THE LICENSE, AND DO NOT INSTALL, DOWNLOAD, ACCESS, OR OTHERWISE COPY OR USE ALL OR ANY PORTION OF THE SOFTWARE UNLESS YOU CAN AGREE WITH ITS TERMS AS SET OUT IN THIS LICENSE AGREEMENT.

1. Entitlement

Barco ClickShare (the "Software") offered as a wireless presentation solution that includes the respective software components as further detailed in the applicable Documentation.

2. In the event of any differences or inconsistencies between translations of the EULA and the English text of the EULA, the English text will prevail.

The Software can be used upon purchase from, and subject to payment of the relating purchase price to, a Barco authorized distributor or reseller of the ClickShare base unit and button or download of the authorized ClickShare applications (each a “Barco ClickShare Product”).

- **Term**

The Software can be used under the terms of this EULA from the date of first use of the Barco ClickShare Product, for as long as you operate such Barco ClickShare Product.

- **Deployment and Use**

The Software shall be used solely in association with a Barco ClickShare Product in accordance with the Documentation issued by Barco for such Product.

2. Support

The Software is subject to the warranty conditions outlined in the Barco warranty rider. Maintenance, including the provision of upgrades and updates to the Software, and helpdesk support are available at your option on the terms of Barco’s then current warranty rider.

Higher maintenance and support levels can be obtained at the moment of product sale or during the Barco ClickShare Product and/or Software warranty term.

Higher maintenance and support levels may be included in the initial transaction if ordered and paid for additionally. It is strongly suggested to maintain the maintenance and support agreement without interruption. Barco reserves the right not to restart maintenance following an interruption by the customer.

3. Terms of use

The Software can be used as set out in the Barco EULA attached hereto.

The provisions of this Product Specific EULA override the Barco generic EULA in case of conflicts or inconsistencies.

In case of (inadvertent or other) non-compliance (e.g. where the actual use overshoots the use authorized hereunder), Barco shall have the option to suspend access to the Software until the non-compliance is remedied, failing of which Barco may terminate the License Agreement as set out herein.

4. Privacy

You are controller for personal data which are being processed via the Software. Therefore, you remain solely responsible for complying with all applicable data protection laws and for implementing and maintaining privacy protection and security measures (especially for components that you provide or control). Barco disclaims any liability in this regard.

Barco created a specific privacy policy for the ClickShare software application for mobile devices, which describes the processing of personal data via this application (<http://www.barco.com/en/about-barco/legal/privacy-policy/clickshare-app>).

5. Other terms

- **Open source components:**

The Software contains software components released under an Open Source license.

A list of the third party components used is available in the Software’s README files, through the “My Barco” section of the Barco website or through other (online) means. The applicable license terms, copyright notices and, as relevant, source code access conditions apply as set out in the Barco EULA attached hereto.

- **Retention of data:**

Barco right to use and retain Functional Information (section 10.2 of the EULA) shall survive the term of this EULA.

C.3 Open source software

Open Source Software provisions

This product contains software components released under an Open Source license. A copy of the source code is available on request by contacting your Barco customer support representative.

EACH SEPARATE OPEN SOURCE SOFTWARE COMPONENT AND ANY RELATED DOCUMENTATION ARE PROVIDED "AS IS" WITHOUT EXPRESS OR IMPLIED WARRANTY INCLUDING, BUT NOT LIMITED TO, THE IMPLIED WARRANTIES OF MERCHANTABILITY AND FITNESS FOR A PARTICULAR PURPOSE. IN NO EVENT SHALL THE COPYRIGHT HOLDER OR ANY OTHER CONTRIBUTOR BE LIABLE FOR DIRECT, INCIDENTAL, SPECIAL, EXEMPLARY OR CONSEQUENTIAL DAMAGES, EVEN IF ADVISED OF THE POSSIBILITY OF SUCH DAMAGES, HOWEVER CAUSED AND ON ANY THEORY OF LIABILITY, WHETHER IN CONTRACT, STRICT LIABILITY, OR TORT (INCLUDING NEGLIGENCE OR OTHERWISE) ARISING IN ANY WAY OUT OF THE USE OF THIS OPEN SOURCE SOFTWARE. MORE INFORMATION/ DETAILS IS TO BE FOUND IN EACH SPECIFIC OPEN SOURCE LICENSE.

Copyright on each Open Source Software component belongs to the respective initial copyright holder, each additional contributor and/or their respective assignee (s), as may be identified in the respective documentation, source code, README file, or otherwise. You shall not remove or obscure or otherwise alter the respective copyrights.

You acknowledge living up to the conditions of each separate Open Source Software license.

The list of Open Source Software components used in the development of the Software can be downloaded from the Barco website via the following URL: <https://www.barco.com/en/support/docs/R5917183>

Index

Numbers/Symbols

Відповідність вимогам України 57

A

About
CX-50 Gen2 7
Additional features 34
Address
Production 54
After use 41
AirPlay 31
Annotations 34
Audio control 25

B

Base Unit 8
Base Unit specifications 50
Base Unit specs 50
Basic 44
Battery
Disposal 55
Blackboarding 34
Button 9, 12
Connection 20
Share 26
Button & app 22
Button specifications 51
Button specs 51
Buttons 12

C

Calendar 37
Outlook 37
Certification 53
ClickShare app
Connection 20
ClickShare Button 9

ClickShare desktop
Install 16
ClickShare mobile
Install 16
Close
Connection 42
Compliance China 64
Compliance EU 54
Compliance FCC 58
Compliance IC 59
Compliance India 65
Compliance Russia 58
Compliance Thailand 65
Compliance Turkey 58
Conference 31, 33
Method 31
Conformidade Anatel 61
Connect
Meeting room 20
Connection
Close 42
End 42
Cumplimiento México 61
CX-50 Gen2 8
CX-50 Gen2 specifications 50
CX-50 Gen2 specs 50

D

Desktop
Share 26
Desktop app
Install 16
Disposal 55
Battery 55

E

End
Connection 42
Hardware 42
End user 68

EULA 68

F

Finish 41

G

Google cast 31

H

Hardware 11

I

Importer 54

Install

ClickShare desktop 16

ClickShare mobile 16

Desktop app 16

Mobile app 16

International safety standards 54

Introduction

CX-50 Gen2 7

J

Join

Meeting 31

One click 32

K

KCC Statement 62

L

Leaving 41

LED ring 8

License 67

Licenses 67

Local view 26

M

Meeting 19

Remote 31

Meeting room

Connect 20

Method 20

Share 26

Microsoft

PowerPoint 37

Miracast 31

Mobile

Share 29

Mobile app

Install 16

N

NCC Statement 63

O

One click 32

Open source 73

Outlook

Calendar 37

P

Pair

Button 12

Buttons 12

Pairing 12

Peripherals 25

Power on 12

PowerPoint

Microsoft 37

PresentSense 20, 22

Preview display 26

Privacy 65

product license 72

R

Regulatory 53

Remote

Meeting 31

RoHS

China 64

S

Safety standards 54

Screenshot 29

Share 19

Application 26

Button 26

Desktop 26

Method 26

Mobile 29

Screen 26

Third party 31

Window 26

Software 15

Specifications 49

Specs 49

Standby mode 12

Stereo audio 26

T

Third party

Share 31

Touch back 36

Trademarks 66

Troubleshooting 43

Turkey RoHS 58

U

UK Compliance 56
Update 18
Use ClickShare 19

W

WEEE 55, 58
Wired roomdock 25



R5900119 /06 | 2026-01-21

www.barco.com