

**FP** FLASHPOINT



Zoom Mini

TTL Flash for Canon **R2**

with Integrated R2 Radio Transceiver

FPLFSMMINICA

# Thank You for Choosing Flashpoint!

The Flashpoint Zoom Mini TTL Speedlight for Canon with Integrated R2 Radio Transceiver is a hotshoe speedlight which is fully compatible with the Canon E-TTL system. These compact and lightweight units as well as their integrated functions and features make them the first choice of professional photographers with smaller interchangeable cameras. If you have any questions or concerns, please feel free to contact us at [Brands@Adorama.com](mailto:Brands@Adorama.com)

## Features

- Powerful Flash with a GN of 80
- Compact size for use with Canon Mirrorless and Compact camera
- Complete Compatibility with the Canon E-TTL system
- Fully Compatible with All On Camera TTL Controls Including Automatic TTL Exposure Control, Exposure Bias, Bracketing, Second Curtain Sync, HSS, EXIF Recording, and Flash Exposure Lock
- Remote TTL and Manual Power Control with the Integrated R2 Radio System's Built In Transmitter and Receiver
- Industry benchmark range and interference avoidance with the new **INTEGRATED** 2.4 GHz R2 Radio System
- Zooming Head for Even Coverage with automatic zoom or manual control
- HSS for Shutter Speeds Up To 1/8000 Second
- Regular and Intelligent Optical Slave Modes
- 360 degree rotation and 90+ degree tilt
- Stable color temperature at 5600±200K over the entire power range
- Backlit Matrix LCD
- Allows for On and Off Camera Use
- Firmware update port
- 1 Year Warranty

## For Your Safety

- Always keep this product dry. Do not use in rain or in damp conditions.
- This product contains high-voltage electronic parts. Touching the high-voltage circuit inside it may result in electric shock. Do not disassemble. Should repairs become necessary, this product must be sent to an authorized maintenance center.
- Stop using this product if it breaks open due to internal shifting, falling or strong impact. STRONG electric shock may occur if you touch the components inside it.
- Do not fire the flash directly into the eyes (especially those of babies and pets) within short distances. Otherwise visual impairment may occur. When taking pictures for babies, keep the flash unit at least 1 meter (3.3 feet) away from them. Using bounce flash to reduce light intensity is also recommended.
- Do not use the flash unit in the presence of flammable gases, chemicals and other similar materials. In certain circumstances, these materials may be sensitive to the strong light emitting from this flash unit and fire may result.
- Do not leave or store the flash unit if the ambient temperature reads over 50°C (e.g. in automobile in the sun). Otherwise the electronic parts may be damaged.
- Do not use any power supply other than the intended one to power the unit.
- Do not insert metal parts into any lighting equipment.
- Do not touch the electrical contacts on the flash or battery or contact them with any conductive materials.
- Power the unit only with two AA batteries. Do not modify the power source or input. Excess voltage can damage the unit and yourself.
- This flash has an over-heat protection circuit, rapid continuous firing will cause the flash to slow operation and trigger a "cool down" period. After this period, the flash will resume normal operation. You may also reboot the flash by cycling the power off and then on.
- Do not use selective coloring.
- Do not use the flash to support other equipment. For example, do not lift your camera by the flash.
- In case of abnormal function, sparks, excessive heat, flames or smoke, immediately power off the unit and disconnect the battery if safely possible. Have it checked by an authorized technician.
- Store the flash with the batteries removed. Storing the flash with the batteries in it can lead to battery leakage.

# Product Layout

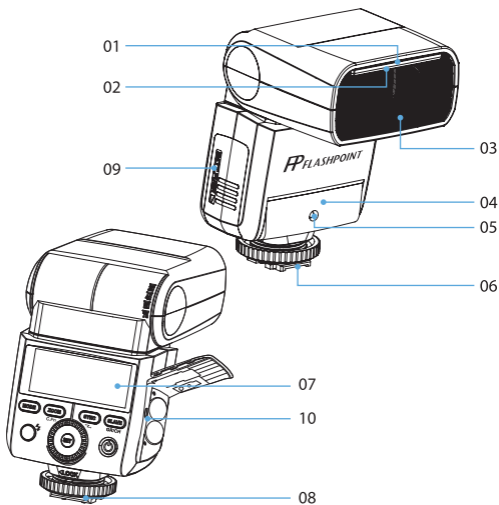

## Body

- |                                     |                                    |
|-------------------------------------|------------------------------------|
| 01. Retractable Bounce Card         | 06. Hotshoe                        |
| 02. Retractable Wide Angle Diffuser | 07. LCD Panel                      |
| 03. Flash Head                      | 08. Lock Ring                      |
| 04. Optical Slave Sensor            | 09. Battery Compartment            |
| 05. Focus Assist Beam               | 10. USB Port for Firmware Upgrades |

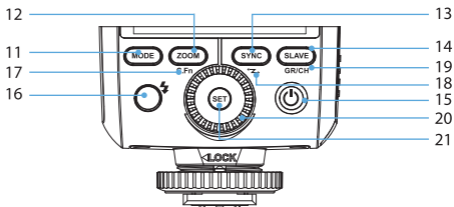

## Control Panel

- |  |   |
|--|---|
| 11. <b>&lt;MODE&gt;</b> Mode Selection Button                              | 17. <b>&lt;C.Fn&gt;</b> Custom Function Setting Button (long press for 2 seconds) |
| 12. <b>&lt;ZOOM&gt;</b> Zoom Button  | 18. <b>&lt;Z&gt;</b> Wireless Selection Button (long press for 2 seconds)         |
| 13. <b>&lt;SYNC&gt;</b> High-Speed Sync Button                             | 19. <b>&lt;GR/CH&gt;</b> Group/Channel Button (in wireless mode)                  |
| 14. <b>&lt;SLAVE&gt;</b> S1/S2 Optical Slave Button (in non-wireless mode) | 20. Select Dial   |
| 15. <b>&lt;P&gt;</b> Power Switch  | 21. <b>&lt;SET&gt;</b> Set Button   |
| 16. <b>&lt;L&gt;</b> Test Button / Flash Ready Indicator.                  |   |

# LCD Panel

## (1) E TTL Autoflash

**Zoom:** zoom display

**Mode:** E TTL autoflash

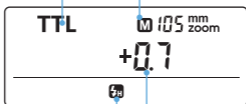

: High Speed Sync Activated

Flash exposure compensation amount

## (2) M Manual Flash

**M:** Manual flash

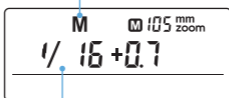

Manual flash output

## (3) Multi Flash

**Multi:** Stroboscopic flash

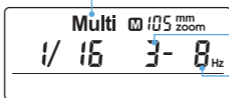

Number of flashes

Flash frequency  
Hz= flashes/second

## (4) Radio Transmission Shooting

### • Master Unit

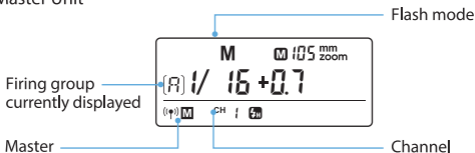

### • Slave Unit

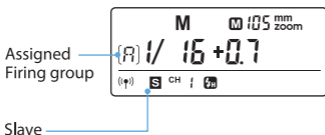

## Included Accessories

1. Flash unit 2. Mini stand 3. Protection case 4. Instruction manual

## Available Accessories

R2 Radios



Flashpoint Grid for Speed Light  
FPLFSMX02



Hexapop/Parapop  
rapid deployment  
Softboxes



Flashpoint  
Speed Light Reflector  
FPLFSMX01



## Attaching to a Camera

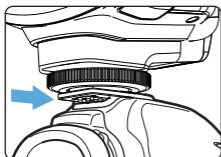

**1** Attach the Camera Flash.

Slip the camera flash's mounting foot into the camera's hotshoe all the way.

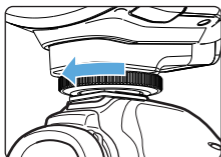

**2** Secure the Camera Flash.

Rotate the lock ring on the mounting foot until it is secure.

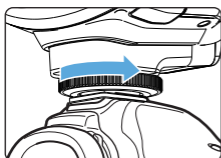

**3** Detach the Camera Flash.

Rotate the lock ring on the mounting foot until it is fully loosened.

## Power Management

Use  Power Switch to power the flash unit on or off. Turn off the unit if it will not be used for an extended period of time. Set as a master flash, it will turn the power off automatically after approx. 60 seconds of idle use. Pressing the camera shutter halfway or pressing any flash button will wake up the flash unit.

Set as a slave flash, it will enter sleep mode after a certain period (adjustable, 60 minutes by default) of idle use. Pressing any flash button will wake it up.



**C.Fn**

Disabling Auto Power off function is recommended when the flash is used off camera. See the Custom Function Menu section.

## Flash Mode: E TTL Autoflash

This flash has three flash modes: E TTL, Manual(M), and Multi (Stroboscopic). In E TTL mode, the camera and the flash will work together to calculate the correct exposure for the subject and the background. In this mode, multiple E TTL functions are available: FEC, HSS, second curtain sync, etc.

- \* Press **<MODE>** Mode Selection Button and three flash modes will display on the LCD panel one by one with each press.

### E TTL Mode

- \* Press **<MODE>** Mode Selection Button to enter E TTL Automatic mode. The LCD panel will display **<TTL>**.
- Press the camera release button halfway to focus.
- When the shutter button is fully pressed, the flash will fire a preflash that the camera will use to calculate exposure and flash output the instant before the photo is taken.

### Out of Range Notifications

**“HI”**: When the flash output value is up to the maximum power, “HI” will be displayed and blink for 3 seconds. Adjust the camera’s parameters if underexposure occurs.

**“Lo”**: When the flash output value is up to the minimum power, “Lo” will be displayed and blink for 3 seconds. Adjust the camera’s parameters if overexposure occurs.

## FEC: Flash Exposure Compensation

With FEC function, this flash can bias the flash output from -3 to +3 in 1/3rd stops. It is useful in situations where minor adjusting of the TTL system is needed based on the environment.

### Setting FEC:

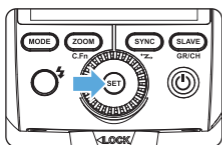

**1** Press the **<SET>** Button and the flash exposure compensation amount will be highlighted on the LCD panel.



**2**

- Turn the Select Dial to set the amount.
- "0.3" means 1/3 stop.
- "0.7" means 2/3 stop.
- To cancel the flash exposure compensation, set the amount to "+0".

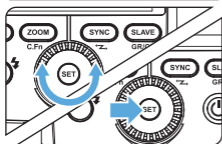

**3** Press **<SET>** button again to confirm the setting.

## High-Speed Sync

High Speed Sync (FP flash) enables the flash to synchronize with all camera shutter speeds. This is convenient when you want to use aperture priority for fill-flash portraits.

Press the **<SYNC>** button to turn on high-speed sync flash and **<H>** is displayed. Then, adjust the SONY camera's shutter to achieve high-speed sync flash.

- With high-speed sync, the faster the shutter speed, the shorter the effective flash range.
- Stroboscopic mode cannot be set in high-speed sync mode.
- Over-heat protection may be activated after 10 consecutive high-speed sync flashes.

## Second-Curtain Sync

With a slow shutter speed, you can create a light train following the subject. The flash fires right before the shutter closes.

- Set the camera to Rear curtain mode to activate rear curtain sync.



## M: Manual Flash

The flash output is adjustable from 1/1 full power to 1/128th power in 1/3rd stop increments. To obtain a correct flash exposure, use a hand-held flash meter to determine the required flash output.

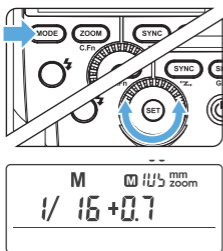

1 Press **<MODE>** button so that **<M>** is displayed.

2 Turn the Select Dial to choose a desired flash output amount.

In **S<sub>H</sub>** high-speed sync mode, the adjustable flash range is 1/16~1/1.

## Flash Output Levels

The following table makes it easier to see how the display changes in terms of f/stop when you increase or decrease the flash output. For example, when you decrease the flash output to 1/2, 1/2-0.3, or 1/2-0.7, and then increase the flash output to more than 1/2, 1/2+0.3, 1/2+0.7, and 1/1 will be displayed.

Figures displayed when reducing flash output level→

1/1	1/1-0.3	1/1-0.7	1/2	1/2-0.3	1/2-0.7	1/4	.....
	1/2+0.7	1/2+0.3		1/4+0.7	1/4+0.3		.....

←Figures displayed when increasing flash output level

### Optical Slave S1

In M manual flash mode, press **<SLAVE>** button so that this flash can be triggered as an optical slave. With this function, the flash will fire simultaneously when the main flash fires. Use this mode when firing another manual powered flash, and in areas where no one else is doing flash photography.

### Intelligent Optical Slave S2

Press **<SLAVE>** button so that this flash can be triggered as an intelligent optical slave. This is useful when triggering with a TTL flash. In this mode, the flash will ignore a single “preflash” from the main flash and will only fire in response to the second, actual flash from the main unit. Use this mode when firing a TTL speedlight, and in areas where no one else is doing flash photography.



- S1 and S2 optic triggering and off camera high-speed mode are only available in M manual flash mode.

# Flash Mode – MULTI: Stroboscopic Flash

With stroboscopic flash, a rapid series of flashes is fired. It can be used to capture multiple images of a moving subject in a single photograph. You can set the firing frequency (number of flashes per sec. expressed as Hz), the number of flashes, and the flash output.

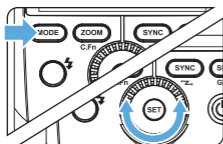

1 Press < **MODE** > button so that < **Multi** > is displayed.

2 Turn the Select Dial to choose a desired flash output.

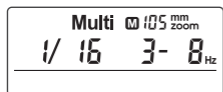

3 Set the flash frequency and flash times.

- Press the < **SET** > Button to select the flash frequency. Turn the Select Dial to set the number.
- Press the < **SET** > Button again to select the flash times. Turn the Select Dial to set the number.

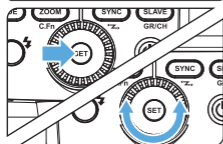

## Calculating the Shutter Speed

During stroboscopic flash, the shutter should remain open until the firing stops. Use the formula below to calculate the shutter speed and set it with the camera.

$$\text{Number of Flashes} / \text{Flash Frequency} = \text{Shutter Speed}$$

For example, if the number of flashes is 10 and the firing frequency is 5 Hz, the shutter speed should be at least 2 seconds.

 To avoid overheating and deteriorating the flash head, do not use stroboscopic flash more than 10 times in succession. After 10 times, allow the camera flash to rest for at least 15 minutes. If you try to use the stroboscopic flash more than 10 times in succession, the firing might stop automatically to protect the flash head. If this happens, allow at least 15 minutes' rest for the camera flash.

- Stroboscopic flash is most effective with a highly reflective or light colored subject against a dark background.
- Using a tripod and a remote control is recommended.
- A flash output of 1/1 and 1/2 cannot be set for stroboscopic flash.
- Stroboscopic flash can be used with "bulb".
- If the number of flashes is displayed as "--", the firing will continue until the shutter closes or the battery is exhausted. The number of flashes will be limited as shown by the following table.

## Maximum Stroboscopic Flashes:

Flash output \ Hz	1	2	3	4	5	6-7	8-9	10	20-50	60-99
1/4	7	6	5	4	4	3	3	2	2	2
1/8	14	14	12	10	8	6	5	4	4	4
1/16	30	30	30	20	20	20	10	8	8	8
1/32	60	60	60	50	50	40	30	20	16	12
1/64	90	90	90	80	80	70	60	50	30	20
1/128	90	90	90	90	90	90	80	70	40	40

## Wireless Flash Shooting: R2 (2.4G) Transmission

- You can set up three slave groups for TTL autoflash shooting. With TTL autoflash, you can easily create various lighting effects.
- Any flash setting for the slave units on the master flash in TTL mode will be automatically sent to the slave units. So the only thing you need to do is to set the master unit for each slave group without any operation for the slave units at all during the shooting.
- This flash can work in TTL/M/Multi/OFF flash modes when set as a master unit.

- Even with multiple slave units, the master unit can control all of them via wireless.
- In this user manual, “master unit” refers to the camera flash on a camera and “slave unit” will be controlled by the master unit.

### 1. R2 Wireless Settings

You can switch between normal flash and wireless flash. For normal flash shooting, be sure to set the wireless setting to OFF.

#### Master Unit Setting

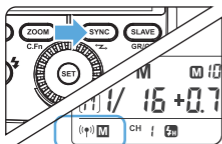

- 1 Long Press the <SYNC> button for 2 seconds so that <(M)> is blinking. Turn the Select Dial until the <(M)> is displayed on the LCD panel, which means the flash is set as the master unit.

#### Slave Unit Setting

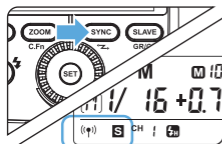

- 1 Long Press the <SYNC> button for 2 seconds so that <(S)> is blinking. Turn the Select Dial until the <(S)> is displayed on the LCD panel, which means the flash is set as a slave unit.

## 2. Setting Each Unit's Flash Mode

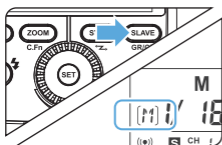

1 Press the **<SLAVE>** Button to choose the group from **M/A/B/C**. Then, press the **<MODE>** Button so that the selected group will work in **OFF / TTL / M** flash mode. Choose one of them as the flash mode of each group and the master unit.

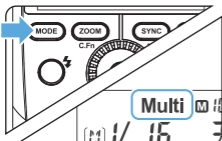

2 Press the **<MODE>** Button for 2 seconds to switch to Multi mode.

## 3. Setting the Communication Channel

If there are other wireless flash systems nearby, you can change the channel IDs to prevent signal interference. The channel IDs of the master unit and the slave unit(s) must be set to the same.

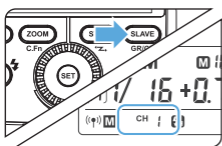

1 Long press the **<SLAVE>** Button for 2 seconds until the channel IDs is blinking. Turn the Select Dial to choose a channel ID from 1 to 16.

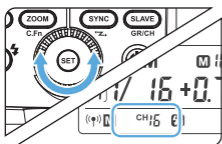

2 Press the **<SET>** button to confirm.

## Other Features

### Auto Focus Assist Beam

In poorly-lit or low-contrast shooting environments, the built-in auto focus assist beam will automatically activate to make it easier for autofocus. The beam will activate only when autofocus is difficult and turn off as soon as the autofocus is achieved.

If you want to turn off the auto focus assist beam, set the "AF" to "OFF" in the C.Fn settings.

- When not attaching to the camera, the auto focus assist beam does not light up.
- When using on Interchangeable Lens Digital Cameras (e.g. ILCE6000L, a7RII, etc.), the auto focus assist beam does not light up.
- When only using on DSLR cameras (e.g. a99, a77II, etc.), the auto focus assist beam does light up.

Position	Effective Range
Center	0.6~4m/2.0~13.1f
Periphery	0.6~2.5m/2.0~8.2ft

## Bounce Flash

By pointing the flash head toward a wall or ceiling, the flash will bounce off the surface before illuminating the subject. This can soften shadows behind the subject for a more natural-looking shot. This is called bounce flash.

To set the bounce direction, hold the flash head and turn it to the desired angle.

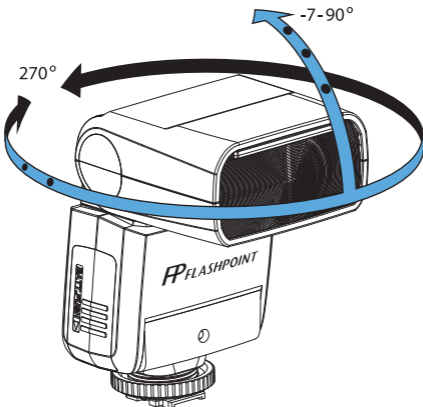

- If the wall or ceiling is too far away, the bounced flash might be too weak and result in underexposure.
- The wall or ceiling should be a plain, white color for high reflectance. If the bounce surface is not white, a color cast may appear in the picture.

## Creating a Catchlight

With the catchlight panel, you can create a catchlight in the subject's eyes to add life to the facial expression.

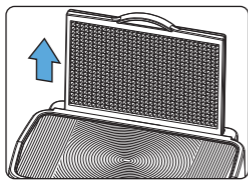

1 Point the flash head upward to 90°.

2 Pull out the wide angle diffusion panel. The catchlight panel will come out at the same time.

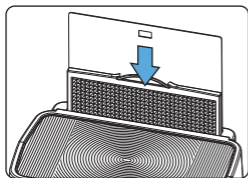

3 Push the wide angle diffusion panel back in.

- Push in only the wide angle diffusion panel.
- Follow the same procedures as for bounce flash.

- ⚠ • Point the flash head straight ahead and then upward to 90°. The catchlight will not appear if you swing the flash head left or right.
- For best catchlight effect, stay 1.5m/4.9ft away from the subject.

## ZOOM: Setting the Flash Coverage and Using the Wide Angle Diffusion Panel

The flash coverage can be set automatically or manually. It can be set to match the lens focal length from 24mm to 105mm. Also, with the built-in wide panel, the flash coverage can be expanded for 14mm wide-angle lenses.

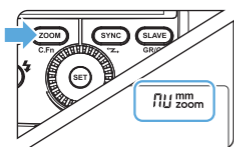

In Manual Zoom mode, press the **<ZOOM>** button.

- Turn the Select Dial to change the flash coverage.
- If **<AU>** is displayed, the flash coverage will be set automatically.

- If you set the flash coverage manually, make sure it covers the lens focal length so that the picture will not have a dark periphery.
- When the low battery indicator is displayed, the ZOOM will constantly be 24mm.
- If the flash will not adjust from 14mm zoom, it means the wide angle panel is not pushed in all the way. Push in the wide angle panel to resume manual or automatic zoom.

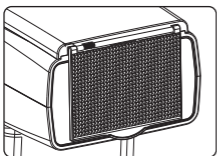

## Using the Wide Angle Diffusion Panel

Pull out the wide angle diffusion panel and place it over the flash head as shown. The flash coverage will then be expanded to 14 mm.

- The catchlight panel will come out at the same time. Push the catchlight panel back in.
- The <ZOOM> button will not work.

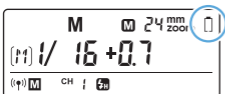

## Low Battery Warning

If the battery power is low, <Battery Icon> will appear and blink on the LCD panel. Please replace the batteries immediately.

## C.Fn: Setting Custom Functions

The following table lists the available and unavailable custom functions of this flash.

C.Fn Custom Functions			
Custom Function Signs	Function	Setting No.	Settings & Description
ST	Auto sleep (standby)	ON	ON
		OF	OFF
AF	AF-assist beam	ON	ON
		OF	OFF
BL	Backlighting control	10 sec.	Off in 10 sec.
		OF	Always off
		ON	Always lighting

1. Press the <ZOOM> Button for 2 seconds until C.Fn menu is displayed.
2. Turn the Select Dial to select the Custom Functions.
3. Press the <SET> Button and the Setting No. blinks.
4. Turn the Select Dial to set the desired number. Pressing the <SET> Button will confirm the settings.
5. Press the <ZOOM> Button to exit.

## Protection Function

### 1. Over-Temperature Protection

- To avoid overheating and deteriorating the flash head, do not fire more than 20 continuous flashes in fast succession at 1/1 full power. After 20 continuous flashes, allow a rest time of at least 10 minutes.
- If you fire more than 20 continuous flashes and then fire more flashes in short intervals, the inner over-heat protection function may be activated and make the recycling time over 10 seconds. If this occurs, allow a rest time of about 10 minutes, and the flash unit will then return to normal.
- When the over-heat protection is started,  is shown on the LCD display.

Number of flashes that will activate over-temperature protection:

Power Output Level	Number of Flashes
1/1	30
1/2 +0.7	40
1/2 +0.3	50
1/2	60
1/4 ( +0.3,+0.7 )	100
1/8 ( +0.3,+0.7 )	200
1/16 ( +0.3,+0.7 )	300
1/32 ( +0.3,+0.7 )	500
1/64 ( +0.3,+0.7 )	1000
1/128 ( +0.3,+0.7 )	

Number of flashes that will activate over-temperature protection in high-speed sync triggering mode:

Power Output	Times
1/1	15
1/2(+0.3,+0.7);	20
1/4(+0.3,+0.7)	30
1/8(+0.3,+0.7);	
1/16(+0.3,+0.7)	40

## 2. Other Protections

The system provides real-time protection to secure the device and your safety. The following lists prompts for your reference:

Prompts on LCD Panel	Meaning
E1	A failure occurs on the recycling system so that the flash cannot fire. Please restart the flash unit. If the problem still exists, please send this product to a maintenance center.
E2	The system gets excessive heat. Please allow a rest time of 10 minutes.
E3	The voltage on two outlets of the flash tube is too high. Please send this product to a maintenance center.
E9	There are some errors occurred during the upgrading process. Please using the correct firmware upgrade method.

## Firmware Upgrade

This flash supports firmware upgrade through the USB port. Update information will be released on our official website.

 USB connection line is not included in this product. The USB port is a standard Micro USB socket.

Checking the version: Hold the <MODE> Button and the turn the flash on. Then, the firmware update version (e.g. Version 1.0 will read U-1.0) will be displayed on the LCD panel.



# Technical Data

<b>Model</b>	FPLFSMMINICA
<b>• Type</b>	
Compatible Cameras	Canon Hotshoe Cameras
Guide No. (1/1 output @ 105mm)	80Ft. /24 Meters @ISO 100 105mm zoom
Flash Coverage	24 to 105mm
	• Auto zoom (Flash coverage set automatically to match the lens focal length and image size)
	• Manual zoom
	• Rotating/tilting flash head (bounce flash): 0 to 360° horizontally and -7° to 90° vertically
Flash Duration (t0.1)	1/350 to 1/20000 seconds
<b>• Exposure Control</b>	
Exposure control system	TTL autoflash and manual flash
Flash exposure compensation (FEC)	Manual. FEB: ±3 stops in 1/3 stop increments (Manual FEC can be combined.)
Sync mode	High-speed sync (up to 1/8000 seconds), first-curtain sync, and second-curtain sync
Multi flash	Provided (up to 90 times, 100Hz)
<b>• Wireless Flash R2 (2.4G radio transmission)</b>	
Wireless flash function	Master, Slave, Off
Controllable slave groups	3 (A, B and C)
Transmission range (approx.)	≤100m/328ft
Channels	16 (1~16)
Slave-ready indicator	Two red indicators
Modeling flash	Fired with camera's depth-of-field preview button
<b>• Auto Focus Assist Beam</b>	
Effective range (approx.)	Center: 0.6~4m /2.0~13.1f
	Periphery: 0.6~2.5m /2.0~8.2f
<b>• Power Supply</b>	
AA batteries 1.5V	Ni-MH batteries (recommended) or 2*LR6 alkaline batteries
Recycle time	Approx. 0.1-3.9 seconds (Eneloop Ni-MH batteries of Panasonic). Red LED indicator will light up when the flash is ready.
Full power flashes	Approx. 150 (2500mA Ni-MH batteries)
Power saving	Power off automatically after approx. 60 seconds of idle operation. (60 minutes if set as slave)
<b>• Sync Triggering Mode</b>	Hotshoe, optical triggering
<b>• Dimensions</b>	
W × H × D	140×62×38 mm /5.5×2.4×1.5 in
Weight without battery	200g /7.0oz

## Troubleshooting

If there is a problem, refer to this Troubleshooting Guide.

### The Camera Flash cannot be charged.

- The batteries are installed in the wrong direction.  
→ Install the battery is in the correct direction.
- The camera flash's internal battery is exhausted.  
→ If  appears and blinks on the LCD panel, replace the batteries immediately.

### The Camera Flash does not fire.

- The camera flash is not attached securely to the camera.  
→ Attach the flash's mounting foot securely to the camera.
- The electrical contacts of the Camera Flash and camera are dirty.  
→ Clean the contacts with an eraser.

### The power turns off by itself.

- After 90 seconds of idle operation, auto power off takes effect if the flash is set as master.  
→ Press the shutter button halfway or press any flash button to wake up.
- After 60 minutes (or 30 minutes) of idle operation, the flash unit will enter sleep mode if it is set as slave.  
→ Press any flash button to wake up.

### Auto zoom does not work.

- The camera flash is not attached securely to the camera.  
→ Attach the camera flash's mounting foot to the camera.
- If the flash will not adjust from 14mm zoom, it means the wide angle panel is not pushed in all the way. Push in the wide angle panel to resume manual or automatic zoom.

### The flash exposure is underexposed or overexposed.

- You used high-speed sync.  
→ With high-speed sync, the effective flash range will be shorter. Make sure the subject is within the effective flash range displayed.
- You used Manual Flash mode.  
→ Set the flash mode to **TTL** or modify the flash output.

### Photos have dark corners or only parts of the target subject are illuminated.

- The focal length of lens is wider than the flash zoom setting.  
→ Check the flash coverage you set. This flash unit has the flash coverage between 24 and 120mm lens coverage, which fits medium-format cameras. Pull the wide Angle Diffusion panel out to extend the flash coverage.

## Maintenance

- Shut down the device immediately should abnormal operation be detected.
- Avoid sudden impacts, and the product should be dusted regularly.
- It is normal for the flash tube to be warm when in use. Avoid continuous flashes if possible.
- Maintenance of the flash must be performed by an authorized maintenance department which can provide original accessories.
- This product, except consumables e.g. flash tube, is supported with a one-year warranty.
- Unauthorized service will void the warranty.
- If the product had failures or was wet, do not use it until it is repaired by professionals.
- Changes made to the specifications or designs may not be reflected in this manual.

## Compatible Camera Models

Canon EOS Mirrorless M Series, Rebel Series, Digital DSLR's and Compacts with hot shoes.

 This table only lists the tested camera models, not all DSLR series cameras. For the compatibility of other camera models, a self-test is recommended.

## One Year Flashpoint Limited Warranty

Flashpoint warrants to the original purchaser that your Flashpoint Zoom Mini shall be free from defects in material and workmanship for the period of one (1) year from the date of purchase (or delivery as may be required in certain jurisdictions), or thirty (30) days after replacement, whichever comes later.

Flashpoint's entire liability and your exclusive remedy for any breach of warranty shall be, at Flashpoint's option, to repair or replace the hardware, provided that the hardware is returned to the point of purchase or such other place as Flashpoint may direct with a copy of the sales receipt or dated itemized receipt. Flashpoint may, at its option, replace your product, offer to provide a functionally equivalent product, or repair any product with new, refurbished or used parts as long as such parts are in compliance with the product's technical specifications. Any replacement hardware product will be warranted for the remainder of the original warranty period or thirty (30) days, whichever is longer, or for any additional period of time that may be applicable in your jurisdiction. If the product has been discontinued, the warranty provider reserves the right to replace it with a model of equivalent quality and function. This warranty does not cover problems or damage resulting from accident, abuse, misapplication, or any unauthorized repair, modification or disassembly, improper operation or maintenance, normal wear and tear, or usage not in accordance with product instructions or connection to improper voltage supply, use of consumables, such as replacement batteries, not supplied by Flashpoint, except where such restriction is prohibited by applicable law.

Except where prohibited by applicable law, this warranty is nontransferable and is limited to the original purchaser and the country in which the product was purchased. This warranty gives you specific legal rights, and you may also have other rights, including a longer warranty duration that may vary under local laws. To start a warranty claim contact the Flashpoint Customer Service Department to obtain a return merchandise authorization ("RMA") number, and return the defective product to Flashpoint, along with the RMA number and proof of purchase.

### Question about our product line? Need Product Support?

We are proud of our products and celebrate our customers. We are with you, from product selection to everyday use. Be secure with your purchase and reach us as you need.

**Email us:** [brands@adorama.com](mailto:brands@adorama.com)

**Call:** 212-647-9300

**Address:** Adorama Brands, 42 West 18th Street, New York, NY 10011

**You can always contact us at [BRANDS@ADORAMA.COM](mailto:BRANDS@ADORAMA.COM) for personal technical support. Our web site contains a wide range of Support and FAQ pages with valuable technical assistance.**

Flashpoint is a registered trademark of ADORAMA CAMERA.

© 2017 Adorama Camera, Corp. All Rights Reserved.

