

FP FLASHPOINT



Zoom Li-on Mini
TTL Flash for Sony 
with Integrated R2 Radio Transceiver

FPLFSMMINLSO

Thank You for Choosing Flashpoint!

The Flashpoint Zoom Li-on Mini TTL Speedlight for Sony with Integrated R2 Radio Transceiver is a Lithium powered 118GN speedlight, fully compatible with the Sony TTL system. This unique design balances Sony ingenuity in mirrorless compact cameras, ease of use, with stunning light performance. The Zoom Li-on Mini flash takes you as far as you want to go, from connectivity with the vast R2 Family of Flash, Group control, Slave and Master options, to 22 power levels with Exposure Compensation and Lock, High-Speed Sync, and an automatically zooming flashhead from 24-105mm. The Lithium battery enhances the recycle times at approximately 0.1 – 1.7 seconds and provides up to 500 full power pops per charge. The minuscule package matches impeccably upon the Sony perch.

Features

- Compact size for use with Sony compact mirrorless cameras
- Powerful GN of 118ft/36m @ISO100 105mm zoom
- Integrated Sony R2 Radio System Transmitter and Receiver
- Flawless Remote TTL and Manual Power Control for up to 164ft/50m
- TTL automation through Sony Multi Interface Shoe connectivity
- Fully Sony Camera friendly with TTL Exposure Control, Exposure Bias, Second Curtain Sync, HSS, EXIF Recording, Flash Exposure Lock, and AF Assist Beam.
- Zooming Flashhead for even 24–105mm coverage automatically or manually.
- Integrated retractable 14mm wide-angle panel and bounce card
- HSS for Shutter Speeds Up To 1/8000 Second
- Regular S1 and Intelligent S2 Optical Slave Modes
- Head has 270° rotation and -7 to +90° tilt
- Backlit Matrix LCD Panel
- Overheat Protection System

For Your Safety

- Always keep this product dry. Do not use in the rain or damp conditions.
- This product contains high-voltage electronic parts. Touching the high-voltage circuit inside it may result in electric shock. Do not disassemble. Should repairs become necessary, this product must be sent to an authorized maintenance center.
- Stop using this product if it breaks open due to impact or force. Electric shock may occur if you touch the internal parts.
- Do not use the flash unit in the presence of flammable gases, chemicals, and ignitable materials. In certain circumstances, these materials may be sensitive to the intense light or electromagnetic interference emitted from this flash unit.
- Do not leave or store the flash unit if the ambient temperature reaches over 120°F/50°C (e.g., in a sunbathed automobile). Electronic parts may be permanently damaged.
- Do not use any power supply to charge the battery, other than the one included.
- Do not insert metal parts into any lighting equipment.
- Do not touch the electrical contacts on the strobe or battery or contact them with any conductive materials.
- Do not fire the flash directly into the eyes, especially those of babies, within short distances. Visual impairment may occur. When taking pictures of babies, keep the flash unit at least 3.3 feet (1 meter) away from them. Using bounce flash to reduce light intensity is also recommended.
- This strobe has an overheat protection circuit; rapid continuous firing causes the strobe to slow operation and trigger a "cool down" period. After this period, the strobe resumes normal operation. You may also reset the strobe by cycling the power off and then on again.
- The strobe has a locking mechanism to ensure secure operation. To avoid damage, slide the release before removing any reflectors or accessories.
- In case of an abnormal function, sparks, excessive heat, flames or smoke, immediately power off the unit and disconnect the battery, if safely possible. Have it checked by an authorized technician.
- Store the flash with the Lithium battery installed.

Product Layout

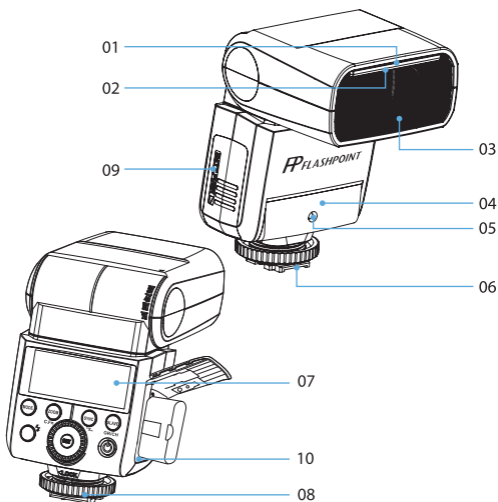

Body

- | | |
|-------------------------------------|------------------------------------|
| 01. Retractable Bounce Card | 06. Hotshoe |
| 02. Retractable Wide Angle Diffuser | 07. LCD Panel |
| 03. Flash Head | 08. Lock Ring |
| 04. Optical Slave Sensor | 09. Battery Compartment |
| 05. Focus Assist Beam | 10. USB Port for Firmware Upgrades |

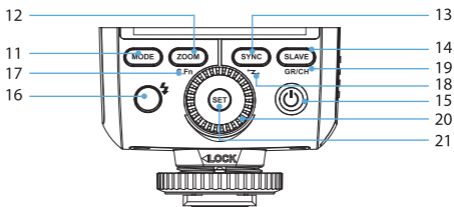

Control Panel

- | | |
|--|---|
| 11. <MODE> Mode Selection Button | 17. <C.Fn> Custom Function Setting Button (long press for 2 seconds) |
| 12. <ZOOM> Zoom Button | 18. <Z> Wireless Selection Button (long press for 2 seconds) |
| 13. <SYNC> High-Speed Sync Button | 19. <GR/CH> Group/Channel Button (in wireless mode) |
| 14. <SLAVE> S1/S2 Optical Slave Button (in non-wireless mode) | 20. Select Dial |
| 15. <⏻> Power Switch | 21. <SET> Set Button |
| 16. <⚡> Test Button / Flash Ready Indicator. | |

LCD Panel

(1) TTL Autoflash

Zoom: zoom display

Mode: TTL autoflash

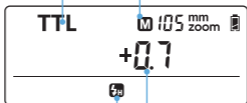

HS: High Speed Sync Activated

Flash exposure compensation amount

(2) M Manual Flash

M: Manual flash

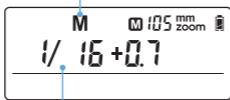

Manual flash output

(3) Multi Flash

Multi: Stroboscopic flash

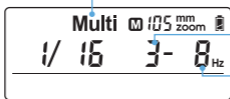

Number of flashes

Flash frequency
Hz= flashes/second

(4) Radio Transmission Shooting

• Master Unit

Flash mode

Firing group currently displayed



Master

Channel

• Slave Unit

Assigned Firing group

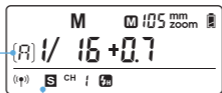

Slave

Included Items

1. Flash unit
2. Mini stand
3. Protection case
4. Diffuser
5. Lithium-ion battery pack
6. Battery charger
7. Battery charger cable
8. Instruction manual

Available Accessories

R2 Radios



Flashpoint Grid for Speed Light
FPLFSMX02



Hexapop/Parapop
rapid deployment
Softboxes



Flashpoint
Speed Light Reflector
FPLFSMX01



Attaching to a Camera

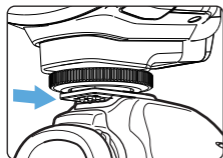

- 1** Attach the Camera Flash.
Slip the camera flash's mounting foot into the camera's hotshoe all the way.

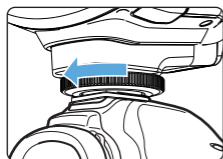

- 2** Secure the Camera Flash.
Rotate the lock ring on the mounting foot until it is secure.

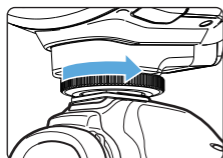

- 3** Detach the Camera Flash.
Rotate the lock ring on the mounting foot until it is fully loosened.

Battery

Features

- This flash unit uses a Lithium-ion polymer battery which has generous reserves and energy potential. The average charge-and-discharge cycles are 500 times.
- The internal circuitry prevents overcharge, over discharge, and short circuit.
- A full charge only takes 2.5 hours using the standard battery charger.

Warnings

- Do not short circuit.
- Do not expose to rain or immerse in water. This battery is not waterproof.
- Store in dry, cool, ventilated places.
- Keep out of reach of children.
- Do not purposely charge for more than 24 hours.
- Do not put this battery into a fire.
- Dispose dead batteries according to local regulations.
- Please charge the battery before storing for extended periods.
- If the battery has not been used for over 3 months, please complete a full recharge.

Loading and Unloading the Battery

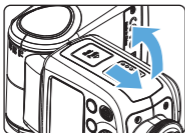

- 1 To load the battery, push the battery compartment cover downward and flip open.

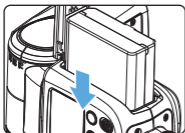

- 2 To load the battery, align to the triangle symbol on the battery pack, and insert it into the compartment until it is locked. Then close the compartment.

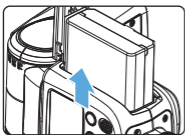

- 3 To unload the battery pack, just slide the battery chamber door downward. The battery cell will pop outward for easy removal.

Battery Level Indication

Make sure the battery pack is securely locked in the flash. Check the battery level indication on the LCD panel to see the remaining battery level.

Battery Level Indication	Meaning
2 grids	Full charge
1 grid	Partial charge
Blank grid	Low charge
Blinking	The battery level is depleted and the flash will auto power off immediately. Recharge the battery as soon as possible to preserve the cells.

Power Management

Use  Power Switch to power the flash unit on or off. Turn off the unit if it will not be used for an extended period of time. Set as a master flash, it will turn the power off automatically after approx. 60 seconds of idle use. Pressing the camera shutter halfway or pressing any flash button will wake up the flash unit.

Set as a slave flash, it will enter sleep mode after a certain period (adjustable, 60 minutes by default) of idle use. Pressing any flash button will wake it up.



C.Fn

Disabling Auto Power off function is recommended when the flash is used off camera. See the Custom Function Menu section.

Flash Mode: TTL Autoflash

This flash has three flash modes: TTL, Manual(M), and Multi (Stroboscopic). In TTL mode, the camera and the flash will work together to calculate the correct exposure for the subject and the background. In this mode, multiple TTL functions are available: FEC, HSS, second curtain sync, etc.

- * Press **<MODE>** Mode Selection Button and three flash modes will display on the LCD panel one by one with each press.

TTL Mode

- * Press **<MODE>** Mode Selection Button to enter TTL Automatic mode. The LCD panel will display **<TTL>**.
- Press the camera release button halfway to focus.
- When the shutter button is fully pressed, the flash will fire a preflash that the camera will use to calculate exposure and flash output the instant before the photo is taken.

Out of Range Notifications

“Hi”: When the flash output value is up to the maximum power, “Hi” will be displayed and blink for 3 seconds. Adjust the camera’s parameters if underexposure occurs.

“Lo”: When the flash output value is up to the minimum power, “Lo” will be displayed and blink for 3 seconds. Adjust the camera’s parameters if overexposure occurs.

FEC: Flash Exposure Compensation

With FEC function, this flash can bias the flash output from -3 to +3 in 1/3rd stops. It is useful in situations where minor adjusting of the TTL system is needed based on the environment.

Setting FEC:

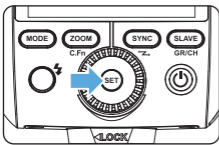

1 Press the **<SET>** Button and the flash exposure compensation amount will be highlighted on the LCD panel.

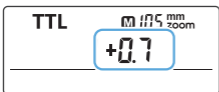

2

- Turn the Select Dial to set the amount.
- "0.3" means 1/3 stop.
- "0.7" means 2/3 stop.
- To cancel the flash exposure compensation, set the amount to "+0".

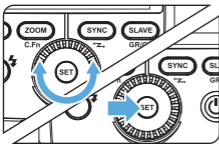

3 Press **<SET>** button again to confirm the setting.

High-Speed Sync

High Speed Sync (HSS) enables the flash to synchronize with all camera shutter speeds. This is convenient when you want to use aperture priority for fill-flash portraits.

Press the **<SYNC>** button to turn on high-speed sync flash and **<H>** is displayed. Then, adjust the SONY camera's shutter to achieve high-speed sync flash.

- With high-speed sync, the faster the shutter speed, the shorter the effective flash range.
- Stroboscopic mode cannot be set in high-speed sync mode.
- Over-heat protection may be activated after 15 consecutive high-speed sync flashes.

Second-Curtain Sync

With a slow shutter speed, you can create a light train following the subject. The flash fires right before the shutter closes.

- Set the camera to Rear curtain mode to activate rear curtain sync.

M: Manual Flash

The flash output is adjustable from 1/1 full power to 1/128th power in 1/3rd stop increments. To obtain a correct flash exposure, use a hand-held flash meter to determine the required flash output.

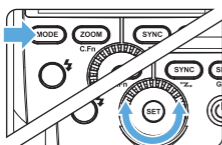

1 Press <MODE> button so that <M> is displayed.

2 Turn the Select Dial to choose a desired flash output amount.

In  high-speed sync mode, the adjustable flash range is 1/16~1/1.

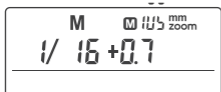

Flash Output Levels

The following table makes it easier to see how the display changes in terms of f/stop when you increase or decrease the flash output. For example, when you decrease the flash output to 1/2, 1/2-0.3, or 1/2-0.7, and then increase the flash output to more than 1/2, 1/2+0.3, 1/2+0.7, and 1/1 will be displayed.

Figures displayed when reducing flash output level→

1/1	1/1-0.3	1/1-0.7	1/2	1/2-0.3	1/2-0.7	1/4
	1/2+0.7	1/2+0.3		1/4+0.7	1/4+0.3	

←Figures displayed when increasing flash output level

Optical Slave S1

In M manual flash mode, press <SLAVE> button so that this flash can be triggered as an optical slave. With this function, the flash will fire simultaneously when the main flash fires. Use this mode when firing another manual powered flash, and in areas where no one else is doing flash photography.

Intelligent Optical Slave S2

Press <SLAVE> button so that this flash can be triggered as an intelligent optical slave. This is useful when triggering with a TTL flash. In this mode, the flash will ignore a single "preflash" from the main flash and will only fire in response to the second, actual flash from the main unit. Use this mode when firing a TTL speedlight, and in areas where no one else is doing flash photography.



S1 and S2 optic triggering and off camera high-speed mode are only available in M manual flash mode.

Flash Mode – MULTI: Stroboscopic Flash

With stroboscopic flash, a rapid series of flashes is fired. It can be used to capture multiple images of a moving subject in a single photograph. You can set the firing frequency (number of flashes per sec. expressed as Hz), the number of flashes, and the flash output.

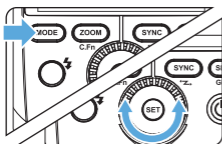

1 Press < **MODE** > button so that < **Multi** > is displayed.

2 Turn the Select Dial to choose a desired flash output.

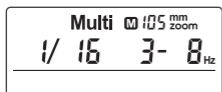

3 Set the flash frequency and flash times.

- Press the < **SET** > Button to select the flash frequency. Turn the Select Dial to set the number.
- Press the < **SET** > Button again to select the flash times. Turn the Select Dial to set the number.

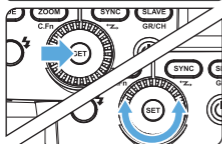

Calculating the Shutter Speed

During stroboscopic flash, the shutter should remain open until the firing stops. Use the formula below to calculate the shutter speed and set it with the camera.

$$\text{Number of Flashes} / \text{Flash Frequency} = \text{Shutter Speed}$$

For example, if the number of flashes is 10 and the firing frequency is 5 Hz, the shutter speed should be at least 2 seconds.

⚠ To avoid overheating and deteriorating the flash head, do not use stroboscopic flash more than 10 times in succession. After 10 times, allow the camera flash to rest for at least 15 minutes. If you try to use the stroboscopic flash more than 10 times in succession, the firing might stop automatically to protect the flash head. If this happens, allow at least 15 minutes' rest for the camera flash.

- Stroboscopic flash is most effective with a highly reflective or light colored subject against a dark background.
- Using a tripod and a remote control is recommended.
- A flash output of 1/1 and 1/2 cannot be set for stroboscopic flash.
- Stroboscopic flash can be used with "bulb".
- If the number of flashes is displayed as "--", the firing will continue until the shutter closes or the battery is exhausted. The number of flashes will be limited as shown by the following table.

Maximum Stroboscopic Flashes:

Flash output \ Hz	1	2	3	4	5	6-7	8-9	10	20-50	60-99
1/4	6	3	2	2	2	2	2	2	2	2
1/8	14	14	6	4	3	3	3	2	2	2
1/16	30	30	30	20	10	8	5	3	3	3
1/32	60	60	60	50	50	40	12	5	5	5
1/64	90	90	90	80	80	70	60	20	10	10
1/128	90	90	90	90	90	90	80	70	30	20

Wireless R2 TTL Flash (2.4Ghz)

- You can set up three slave groups for TTL autoflash.
- With TTL autoflash, you can easily create various strobist lighting effects.
- Any slave flash setting set on the master flash in TTL mode is remotely sent to the slave units through R2 wireless, automatically.
- This flash can work in **TTL/M/Multi/OFF** flash modes when set as a master unit.
- The Flashpoint Zoom Li-on Mini is entirely compatible with the wireless R2 system.
- **As a master unit**, the Zoom Li-on Mini can control the following Flashpoint and Godox equivalents as slave units: **XPLOR600 series, Rapid series, Studio series, Streaklight series, eVOLV200, Zoom speedlight series, and the Zoom Mini, for all camera versions.**
- **As a slave unit**, the Zoom Li-on Mini can be controlled as a slave unit by the following master Flashpoint and Godox equivalents transmitting devices for Sony: **R2Pro, R2T-S, Zoom speedlight series, Streaklight barebulb series, Zoom Li-on Mini, Zoom Mini.**

 In this user manual, "master unit" refers to the camera flash on a camera and "slave unit" will be controlled by the master unit.

1. R2 Wireless Settings

You can switch between normal flash and wireless flash. For normal flash shooting, be sure to set the wireless setting to OFF.

Master Unit Setting

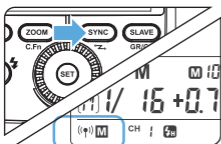

- 1 Long Press the <SYNC> button for 2 seconds so that <((M))> is blinking. Turn the Select Dial until the <((M))> is displayed on the LCD panel, which means the flash is set as the master unit.

Slave Unit Setting

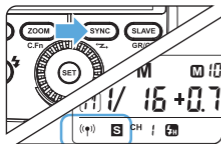

- 1 Long Press the <SYNC> button for 2 seconds so that <((S))> is blinking. Turn the Select Dial until the <((S))> is displayed on the LCD panel, which means the flash is set as a slave unit.

2. Setting Each Unit's Flash Mode

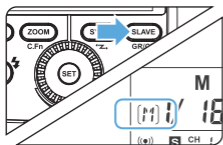

1 Press the **<SLAVE>** Button to choose the group from **M/A/B/C**. Then, press the **<MODE>** Button so that the selected group will work in **OFF / TTL / M** flash mode. Choose one of them as the flash mode of each group and the master unit.

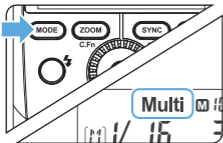

2 Press the **<MODE>** Button for 2 seconds to switch to Multi mode.

3. Setting the Communication Channel

If there are other wireless flash systems nearby, you can change the channel IDs to prevent signal interference. The channel IDs of the master unit and the slave unit(s) must be set to the same.

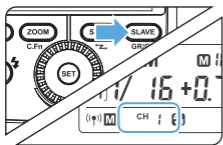

1 Long press the **<SLAVE>** Button for 2 seconds until the channel IDs is blinking. Turn the Select Dial to choose a channel ID from 1 to 16.

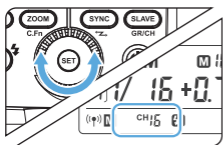

2 Press the **<SET>** button to confirm.

Other Features

Auto Focus Assist Beam

In poorly-lit or low-contrast shooting environments, the built-in auto focus assist beam will automatically activate to make it easier for autofocus. The beam will activate only when autofocus is difficult and turn off as soon as the autofocus is achieved.

If you want to turn off the auto focus assist beam, set the "AF" to "OFF" in the C.Fn settings.

- The autofocus assist beam does not operate if the flash is off camera.
- The autofocus assist beam does not operate when using on a Sony Interchangeable Lens Digital Cameras as the ILCE6000L and a7RII. AF assist function may be provided by the camera directly.
- The autofocus assist beam does operate with attached to a SONY DSLR camera, like the a99 or a77II.

Position	Effective Range
Center	2-13ft/0.6-4m
Periphery	2-8.2ft/0.6-2.5m

Bounce Flash

By pointing the flash head toward a wall or ceiling, the flash will bounce off the surface before illuminating the subject. This can soften shadows behind the subject for a more natural-looking shot. This is called bounce flash.

To set the bounce direction, hold the flash head and turn it to the desired angle.

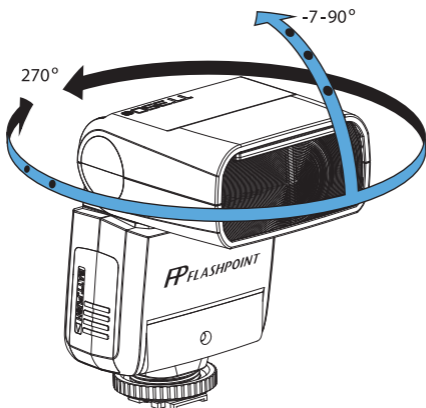

- If the wall or ceiling is too far away, the bounced flash might be too weak and result in underexposure.
- The wall or ceiling should be a plain, white color for high reflectance. If the bounce surface is not white, a color cast may appear in the picture.

Creating a Catchlight

With the catchlight panel, you can create a catchlight in the subject's eyes to add life to the facial expression.

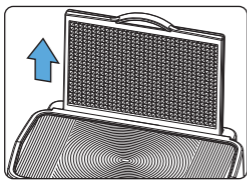

1 Point the flash head upward to 90°.

2 Pull out the wide angle diffusion panel. The catchlight panel will come out at the same time.

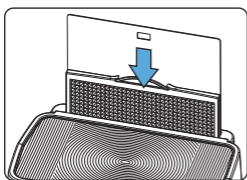

3 Push the wide angle diffusion panel back in.

- Push in only the wide angle diffusion panel.
- Follow the same procedures as for bounce flash.

- ⚠ • Point the flash head straight ahead and then upward to 90°. The catchlight will not appear if you swing the flash head left or right.
- For best catchlight effect, stay 1.5m/4.9ft away from the subject.

ZOOM: Setting the Flash Coverage and Using the Wide Angle Diffusion Panel

The flash coverage can be set automatically or manually. It can be set to match the lens focal length from 24mm to 105mm. Also, with the built-in wide panel, the flash coverage can be expanded for 14mm wide-angle lenses.

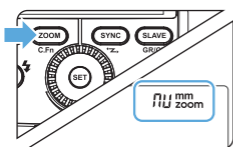

In Manual Zoom mode, press the **<ZOOM>** button.

- Turn the Select Dial to change the flash coverage.
- If **<AU>** is displayed, the flash coverage will be set automatically.

- If you set the flash coverage manually, make sure it covers the lens focal length so that the picture will not have a dark periphery.
- When the low battery indicator is displayed, the ZOOM will constantly be 24mm.
- If the flash will not adjust from 14mm zoom, it means the wide angle panel is not pushed in all the way. Push in the wide angle panel to resume manual or automatic zoom.

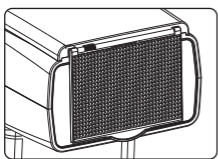

Using the Wide Angle Diffusion Panel

Pull out the wide angle diffusion panel and place it over the flash head as shown. The flash coverage will then be expanded to 14 mm.

- The catchlight panel will come out at the same time. Push the catchlight panel back in.
- The **<ZOOM>** button will not work.

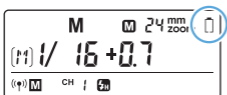

Low Battery Warning

If the battery power is low,  will appear and blink on the LCD panel. Please replace the batteries immediately.

C.Fn: Setting Custom Functions

The following table lists the available and unavailable custom functions of this flash.

C.Fn Custom Functions			
Custom Function	Function	Setting No.	Settings & Description
ST	Auto sleep (standby)	ON	ON
		OF	OFF
AF	AF-assist beam	ON	ON
		OF	OFF
BL	LCD Backlighting control	10 sec.	Off in 10 sec.
		OF	Always Off
		ON	Always On
ID	Wireless ID	OF	OFF
		01-99	Choose any value from 01-99

1. Press the **<ZOOM>** Button for 2 seconds until C.Fn menu is displayed.
2. Turn the Select Dial to select the Custom Functions.
3. Press the **<SET>** Button and the Setting No. blinks.
4. Turn the Select Dial to set the desired number. Pressing the **<SET>** Button will confirm the settings.
5. Press the **<ZOOM>** Button to exit.

Protection Function

1. Over-Temperature Protection

- To avoid overheating and deteriorating the flash head, do not fire more than 30 continuous flashes in fast succession at 1/1 full power. After 30 continuous flashes, allow a rest time of at least 10 minutes.
- If you fire more than 30 continuous flashes and then fire more flashes in short intervals, the inner over-heat protection function may be activated and make the recycling time over 10 seconds. If this occurs, allow a rest time of about 10 minutes, and the flash unit will then return to normal.
- When the over-heat protection is started,  is shown on the LCD display.

Number of flashes that will activate over-temperature protection:

Power Output Level	Number of Flashes
1/1	30
1/2 +0.7	40
1/2 +0.3	50
1/2	60
1/4 (+0.3,+0.7)	100
1/8 (+0.3,+0.7)	200
1/16 (+0.3,+0.7)	300
1/32 (+0.3,+0.7)	500
1/64 (+0.3,+0.7)	1000
1/128 (+0.3,+0.7)	

Number of flashes that will activate over-temperature protection in high-speed sync triggering mode:

Power Output	Times
1/1	15
1/2(+0.3,+0.7);	20
1/4(+0.3,+0.7)	30
1/8(+0.3,+0.7);	
1/16(+0.3,+0.7)	40

2. Other Protections

The system provides real-time protection to secure the device and your safety. The following lists prompts for your reference:

Prompts on LCD Panel	Meaning
E1	A failure occurred on the recycling system so that the flash cannot fire. Please restart the flash unit. If the problem still exists, please send this product to a maintenance center.
E2	The system is overheated. Please allow a rest time of 10 minutes.
E3	The voltage on two outlets of the flash tube is too high. Please send this product to a maintenance center.
E9	Errors occurred during the upgrading process. Please using the correct firmware upgrade method.

Firmware Upgrade

This flash supports firmware upgrade through the USB port. Update information will be released on our official website.



USB connection line is not included in this product.
The USB port is a standard Micro USB socket.

Checking the version: Hold the <MODE> Button and the turn the flash on. Then, the firmware update version (e.g. Version 1.0 will read U-1.0) will be displayed on the LCD panel.

Technical Data

Model	FPLFSMMINLSO
• Type	
Compatible Cameras	Sony Multi Interface Hotshoe Cameras (see list)
Guide No. (1/1 output @ 105mm)	118ft / 36 m @ISO 100
Flash Coverage	24 to 105mm
	• Auto zoom (Flash coverage set automatically to match the lens focal length and image size)
	• Manual zoom
	• Rotating/tilting flash head (bounce flash): 0 to 270° horizontally and -7° to 90° vertically
Flash Duration (t0.1)	1/350 to 1/20000 seconds
• Exposure Control	
Exposure control system	TTL autoflash and manual flash
Flash exposure compensation (FEC)	Manual. FEB: ±3 stops in 1/3 stop increments (Manual FEC can be combined.)
Sync mode	High-speed sync (up to 1/8000 seconds), first-curtain sync, and second-curtain sync
Multi flash	Up to 90 times, 100Hz
• Wireless Flash R2 (2.4G radio transmission)	
Wireless flash function	Master, Slave, Off
Controllable slave groups	3 (A, B and C)
Transmission range (approx.)	Up to 164ft/50m
Channels	16 (1~16)
• Auto Focus Assist Beam	
Effective range (approx.)	Center: 2~13ft/0.6~4m
	Periphery: 2~8.2ft/0.6~2.5m
• Power Supply	
Lithium-Ion	7.2v/2000mAh
Recycle time	0.1~1.7 seconds
Full power flashes	Over 500
Power saving	Power off automatically after approx. 60 seconds of idle operation. (60 minutes if set as slave)
• Sync Triggering Mode	Hotshoe, optical triggering
• Dimensions	
W × H × D	5.9×2.4×1.5 in/150×62×38mm
Weight without battery	7.4oz/210g
Weight with battery	10.3oz/290g

This flash can be used on the following Sony camera models: A7RIII, a7rII, a7R, a58, a99, ILCE6000L, a77II, RX10, and the a9.



- Only tested camera models have been listed, not all Sony cameras. For the compatibility of other camera models, a self-test is recommended.
- Rights to modify this table are retained.

Troubleshooting

If there is a problem, refer to this Troubleshooting Guide.

The Camera Flash dose not fire.

- The camera flash's internal battery is exhausted.
→ If  appears and blinks on the LCD panel, recharge immediately.
- The camera flash is not attached securely to the camera.
→ Attach the flash's mounting foot securely to the camera.
- The electrical contacts of the Camera Flash and camera are dirty.
→ Clean the contacts with an eraser.

The power turns off by itself.

- After 90 seconds of idle operation, auto power off takes effect if the flash is set as master.
→ Press the shutter button halfway or press any flash button to wake up.
- After 60 minutes of idle operation, the flash unit will enter sleep mode if it is set as slave.
→ Press any flash button to wake up.

Auto zoom does not work.

- The camera flash is not attached securely to the camera.
→ Attach the camera flash's mounting foot to the camera.
- If the flash will not adjust from 14mm zoom, the wide angle panel is not pushed in all the way. Push in the wide angle panel to resume manual or automatic zoom.

The flash exposure is underexposed or overexposed.

- You used high-speed sync.
→ With high-speed sync, the effective flash range will be shorter. Make sure the subject is within the effective flash range displayed.
- You used Manual Flash mode.
→ Set the flash mode to **TTL** or modify the flash output.

Photos have dark corners or only parts of the target subject are illuminated.

- The focal length of lens is wider than the flash zoom setting.
→ Check the flash coverage you set. This flash unit has the flash coverage between 24 to 120mm. Pull the wide Angle Diffusion panel out to extend the flash coverage to 14mm.

Maintenance

- Shut down the device immediately should abnormal operation be detected.
- Avoid sudden impacts, and the product should be dusted regularly. It is normal for the flash tube to be warm when in use. Avoid continuous flashes if possible.
- Maintenance of the flash must be performed by an authorized maintenance department which can provide original accessories. This product, except consumables e.g. flash tube, is supported with a one-year warranty.
- Unauthorized service will void the warranty. If the product had failures or was wet, do not use it until it is repaired by professionals.
- Changes made to the specifications or designs may not be reflected in this manual.