

FP FLASHPOINT



Zoom TTL Flash FP
for Fujifilm
with integrated R2 Radio Transceiver

FPLFSMZFU

Thank You for Choosing Flashpoint!

The new Flashpoint Zoom TTL Speedlight for Fujifilm with Integrated R2 Radio Transceiver is a hotshoe speedlight which is fully compatible with the Fujifilm TTL system. The incredible amount of power produced by this compact and lightweight unit, as well as their integrated functions and features, make the Zoom TTL the first choice of professional photographers. If you have any questions or concerns, please feel free to contact us at Brands@Adorama.com.

Features

- Extremely Powerful Flash with a GN of 190
- Approximately 230 Full Power Flashes per set of 2500mA Ni-MH AA batteries
- Fully Compatible with All on Fujifilm Camera TTL Controls Including Automatic TTL Exposure Control, Exposure Bias, Bracketing, Second Curtain Sync, HSS, EXIF Recording, Modeling Flash, and Flash Exposure Lock
- Wireless Remote TTL and Manual Power Control with the Integrated R2 Radio System's Built In Transmitter and Receiver
- Industry benchmark range and interference avoidance
- 3 Groups and 32 Channels
- Faster Recycle and Flash Capacity with the Lithium Flashpoint Blast Pack BP-960 accessory option
- Zooming Flash Head for even and efficient coverage with automatic or manual control
- HSS for Shutter Speeds Up To 1/8000s
- Regular and Intelligent Optical Slave Modes
- Backward Compatibility with the Flashpoint R1 Radio Control System for Manual Output Control and Triggering
- 360 degree head rotation and 90+ degree tilt
- Stable color temperature at 5600±200K over the entire power range
- Backlit Matrix LCD
- Multipurpose Buttons with Digital Marking for Faster Navigation Perfect for On and Off Camera Use
- Laser AF Assist Lamp with Crisscross Pattern for Instant Autofocus Even In Complete Darkness on Low Contrast Surfaces
- 1 Year Warranty

Included items

1. Flash unit
2. Mini Stand
3. Protection case
4. Instruction manual

For Your Safety

- Always keep this product dry. Do not use in rain or in damp conditions.
- This product contains high-voltage electronic parts. Touching the high-voltage circuit inside it may result in electric shock. Do not disassemble. Should repairs become necessary, this product must be sent to an authorized maintenance center.
- Stop using this product if it breaks open due to internal shifting, falling or strong impact. STRONG electric shock may occur if you touch the components inside it.
- Do not fire the flash directly into the eyes (especially those of babies and pets) within short distances. Visual impairment may occur. When taking pictures for babies, keep the flash unit at least 1 meter (3.3 feet) away from them.
- Do not use the flash unit in the presence of flammable gases, chemicals and other similar materials. In certain circumstances, these materials may be sensitive to the strong light emitting from this flash unit and fire may result.
- Do not leave or store the unit if the ambient temperature is over 122°F /50°C (e.g. in automobile in the sun). The electronic parts may be damaged.
- Do not insert metal parts into any lighting equipment.
- Do not touch the electrical contacts on the flash or battery or contact them with any conductive materials
- This flash has an over-heat protection circuit, rapid continuous firing will cause the flash to slow operation and trigger a "cool down" period. After this period, the flash will resume normal operation. You may also reboot the flash by cycling the power off and then on.
- Do not use the flash to support other equipment. For example, do not lift your camera by the flash.
- The flash has a locking pin to ensure secure operation. To avoid damage, completely unscrew the locking ring before removing the flash.
- The battery should slide smoothly into the flash. If they do not, remove them, check alignment, and check for obstructions. Do not force the batteries into place.
- Store the flash with the batteries removed. Keeping them inside can lead to battery cell leakage, voiding the warranty.
- In case of abnormal function, sparks, excessive heat, flames or smoke, immediately power off the unit and remove the batteries if possible. Have it checked by an authorized technician.

Name of Parts

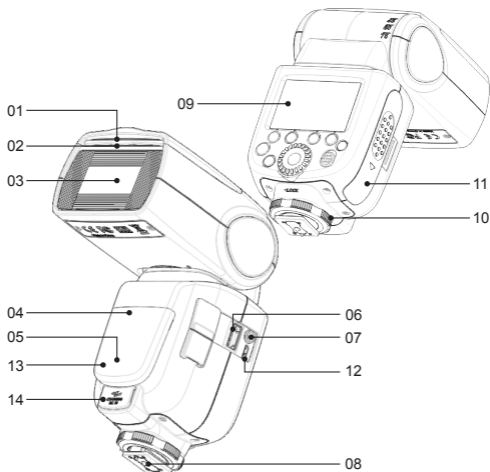

Body

- | | |
|------------------------------------|------------------------------------|
| 1. Retractable Bounce Card | 9. Dot-matrix LCD Panel |
| 2. Retractable Wide Angle Diffuser | 10. Lock Ring |
| 3. Flash Head | 11. Battery Compartment |
| 4. Optical Control Sensor | 12. USB Port for Firmware Upgrades |
| 5. Focus Assist Beam | 13. Slave Flash Ready Indicator |
| 6. R1 Wireless Control Port | 14. External Power Supply Socket |
| 7. Sync Cord Jack | |
| 8. Hotshoe | |

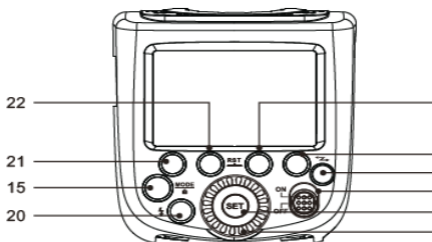

Control Panel

- | | |
|--|---|
| 15. <MODE> Mode Selection Button / Lock button | 20. ⚡ Test Button / Flash Ready Indicator |
| 16. <Z> Wireless Selection Button | 21. Function Button 1 |
| 17. Select Dial | 22. Function Button 2 |
| 18. <SET> Set Button | 23. Function Button 3 |
| 19. ON/OFF Power Switch | 24. Function Button 4 |

LCD Panel

(1) TTL Autoflash

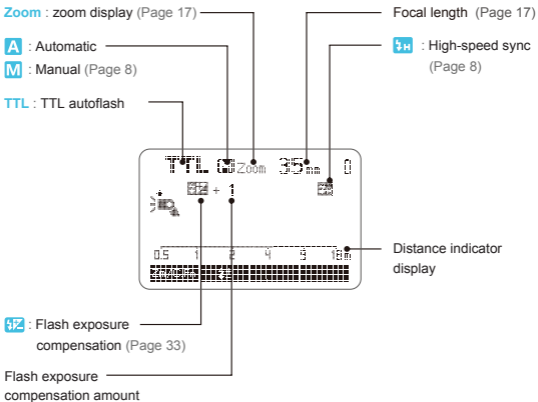

- The display will only show the settings currently applied.
- The functions displayed above buttons 1 to 4, such as **FZ** and **SYNC**, change according to various setting status.
- When a button or dial is operated, the LCD panel illuminates.

(2) M : Manual Flash

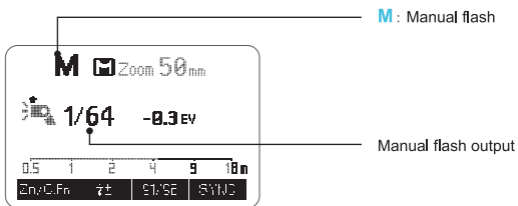

(3) Multi Flash (Stroboscopic)

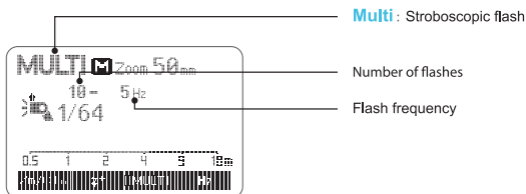

(4) Radio Transmission Shooting

• Master Unit

 : Radio transmission wireless shooting

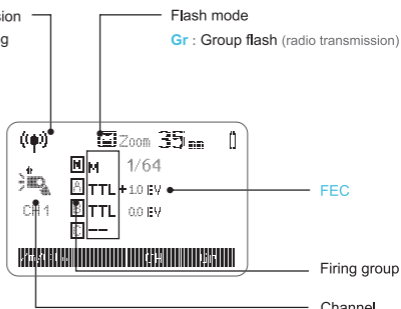

• Slave Unit

 : Slave icon

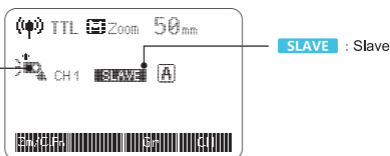

Power Management

Insert 4 AA batteries of the same type and strength into the battery compartment on the left side of the flash body.

Use ON/OFF Power Switch to power the flash unit on or off. Turn off the unit if it will not be used for an extended period of time. Set as a master flash, it will turn the power off automatically after approximately 90 seconds of idle use. Pressing the camera shutter halfway or pressing any flash button will wake up the flash unit. Set as a slave flash, it will enter sleep mode after a certain period (adjustable; 60 minutes by default) of idle use. Pressing any button will wake it up.

Attaching to a Camera

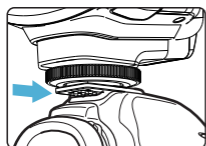

- 1 Attach the Camera Flash**
Slip the camera flash's mounting foot into the camera's hotshoe all the way.

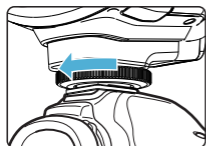

- 2 Secure the Camera Flash.**
Rotate the lock ring on the mounting foot until it is secure.

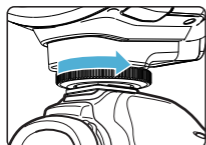

- 3 Detach the Camera Flash.**
Rotate the lock ring on the mounting foot until it is fully loosened.



C.Fn Disabling Auto Power Off function is recommended when the flash is used off camera. See the Custom Function Menu section.

C.Fn Slave Auto Power Off Timer is set to 60 minutes by default. Another option "30 minutes" is available. See the Custom Function Menu section.

Flash Mode: TTL Autoflash

This flash has three flash modes: TTL, Manual (M), and Multi (Stroboscopic). In TTL mode, the camera and the flash will work together to calculate the correct exposure for the subject and the background. In this mode, multiple TTL functions are available: Flash Exposure Compensation (FEC), High Speed Sync (HSS), and second curtain sync.

* Press <MODE> Mode Selection Button and three flash modes will display on the LCD panel one by one in sequence, with each pressing.

TTL Mode

Press <MODE> Mode Selection Button to enter TTL mode. The LCD panel will display <TTL>.

- Press the camera release button halfway to focus. The aperture and effective flash range will be displayed in the viewfinder.
- When the shutter button is fully pressed, the flash will fire a pre-flash that the camera will use to calculate exposure and flash output the instant before the photo is taken.

FEC: Flash Exposure Compensation

With FEC function, this flash can adjust from -3 to +3 in 1/3rd stops. It is useful in situations where minor adjusting of the TTL system is needed based on the environment.

Setting FEC:

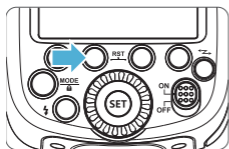

- 1 Press Function Button 2 <Fn2>. The icon <FEC> and flash exposure compensation amount will be highlighted on the LCD panel.

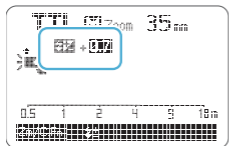

- 2 Set the flash exposure compensation amount.
 - Turn the Select Dial to set the amount.
 - "0.3" means 1/3 step, "0.7" means 2/3 step.
 - To cancel the flash exposure compensation, set the amount to "+0".

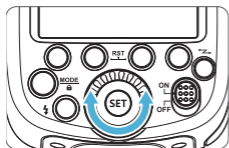

- 3 Press <SET> button again to confirm the setting.

⚡ High-Speed Sync

High Speed Sync (Hss flash) enables the flash to synchronize with all camera shutter speeds. This is convenient when you want to use aperture priority for fill-flash portraits.

Press the <SYNC> button to turn on high-speed sync flash and ⚡ is displayed. Then, adjust the camera's shutter to achieve high-speed sync flash.



- With high-speed sync, the faster the shutter speed, the shorter the effective flash range.
- Multi flash mode cannot be set in high-speed sync mode.
- Over-temperature protection may be activated after 15 consecutive high-speed sync flashes.

Second-Curtain Sync

With a slow shutter speed, you can create a light train following the subject. The flash fires right before the shutter closes.

- Setting the Second-Curtain Sync function on the camera menu, please read camera instruction manual.

When choosing "REAR" on the "SYNC" setting choices, it means the second-curtain sync function is turned on.

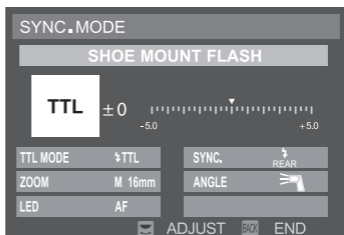

Flash Modes M: Manual Flash

The flash output is adjustable from 1/1 full power to 1/128th power in 1/3rd stop increments. To obtain a correct flash exposure, use a hand-held flash meter to determine the required flash output.

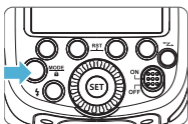

- 1 Press < MODE > button so that < M > is displayed.

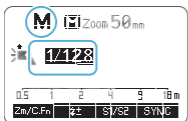

- 2 Turn the Select Dial to choose a desired flash output amount.

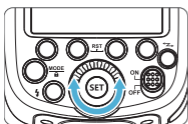

- 3 Press < SET > button again to confirm the setting.

Flash Output Levels

The following table makes it easier to see how the display changes in terms of f/stop when you increase or decrease the flash output. For example, when you decrease the flash output to 1/2, 1/2-0.3, or 1/2-0.7, and then increase the flash output to more than 1/2, 1/2+0.3, 1/2+0.7, and 1/1 will be displayed.

Figures displayed when reducing flash output level →

1/1	1/1-0.3	1/1-0.7	1/2	1/2-0.3	1/2-0.7	1/4
	1/2+0.7	1/2+0.3		1/4+0.7	1/4+0.3	

← Figures displayed when increasing flash output level

Optical S1 Secondary Unit Setting

In M, manual flash mode, press Function Button 3 < **S1/S2** > button so that this flash can function as an optic S1 secondary flash with optic sensor. With this function, the flash will fire synchronously when the main flash fires, the same effect as that by the use of radio triggers. This helps create multiple lighting effects.

Optical S2 Secondary Unit Setting

Press Function Button 3 < **S1/S2** > button so that this flash can also function as an optic S2 secondary flash with optic sensor in M manual flash mode. This is useful when cameras have pre-flash function. With this function, the flash will ignore a single “preflash” from the main flash and will only fire in response to the second, actual flash from the main unit.

Manual Off Camera High-speed Setting (Non-Flashpoint wireless R2 system)

In M, manual flash mode, press Function Button 4 < **SYNC** > button to select high-speed mode and **⚡H** is displayed.



S1 and S2 optic triggering and off camera high-speed mode are only available in M manual flash mode.

Flashpoint Accessories



R2 Radios



R1 Radios



Blast Power Pack
BP-960



Speedlight
Reflector



Flash Diffuser



Hexapop/Parapop
Rapid Deployment
Softboxes

Flash Modes – Multi / Stroboscopic

With stroboscopic flash, a rapid series of flashes is fired. It can be used to capture a multiple images of a moving subject in a single photograph.

You can set the firing frequency (number of flashes per sec. expressed as Hz), the number of flashes, and the flash output.

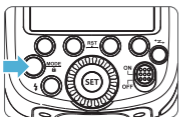

1 Press <MODE> button so that <MULTI> is displayed.

2 Turn the Select Dial to choose a desired flash output.

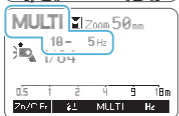

3 Set the flash frequency and flash times.

- Press Function Button 3 <MULTI> to select the flash times. Turn the Select Dial to set the number.
- Press Function Button 4 <Hz> to select the flash frequency. Turn the Select Dial to set the number.
- After you finish the setting, press <SET> button and all the settings will be displayed.

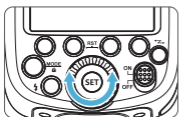

Calculating the Shutter Speed

During stroboscopic flash, the shutter remains open until the firing stops. Use the formula below to calculate the shutter speed and set it with the camera.

$$\text{Number of Flashes} / \text{Flash Frequency} = \text{Shutter Speed}$$

For example, if the number of flashes is 10 and the firing frequency is 5 Hz, the shutter speed should be at least 2 seconds.



To avoid overheating and deteriorating the flash head, do not use stroboscopic flash more than 10 times in succession. After 10 times, allow the camera flash to rest for at least 15 minutes. If you try to use the stroboscopic flash more than 10 times in succession, the firing might stop automatically to protect the flash head. If this happens, allow at least 15 minutes' rest for the camera flash.



Stroboscopic flash is most effective with a highly reflective subject against a dark background.

- Using a tripod and a remote control is recommended.
- A flash output of 1/1 and 1/2 cannot be set for stroboscopic flash.
- Stroboscopic flash can be used with "bulb".
- If the number of flashes is displayed as "--", the firing will continue until the shutter closes or the battery is exhausted. The number of flashes will be limited as shown by the following table.

Maximum Stroboscopic Flashes:

Flash output \ Hz	1	2	3	4	5	6-7	8-9	10	11	12-14	15-19	20-50	60-200
1/4	7	6	5	4	4	3	3	2	2	2	2	2	2
1/8	14	14	12	10	8	6	5	4	4	4	4	4	4
1/16	30	30	30	20	20	20	10	8	8	8	8	8	8
1/32	60	60	60	50	50	40	30	20	20	20	18	16	12
1/64	90	90	90	80	80	70	60	50	40	40	35	30	20
1/128	100	100	100	100	100	90	80	70	70	60	50	40	40

Wireless Flash Shooting: R2 Radio (2.4G) Transmission

- You can set up three slave groups for TTL autoflash shooting. With TTL autoflash, you can easily create various lighting effects.
- Any flash settings for the slave units on the master flash in TTL/Manual/Multi mode will be automatically sent to the slave units. So the only thing you need to do is to set the master unit for each slave group without any operation for the slave units at all during the shooting.
- This flash can work in **TTL / M / Multi / OFF** flash modes when set as a master unit.

As a slave unit, this Zoom TTL Speedlite for Fujifilm is compatible with Flashpoint R2 series transmitters for receiving the signal for triggering from R2T-C (for Canon), R2T-N (for Nikon), R2T-S (for Sony), R2T-F (for Fuji), and R2T-O (for Olympus / Panasonic) .



- Even with multiple slave units, the master unit can control all of them via wireless.
- In this user manual, "master unit" refers to the camera flash on a camera and "slave unit" will be controlled by the master unit.

1. Wireless R2 Settings

You can switch between normal flash and wireless flash. For normal flash shooting, be sure to set the wireless setting to OFF.

Master Unit Setting

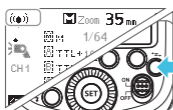

1

Press **<Z>** button so that **<(P)>** is displayed on the LCD panel. If **<(P) MULTI>** is displayed, it means Multi mode is ON.

2

The backlight now turns green.

Slave Unit Setting

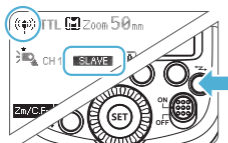

- 1 Press < ((P)) > button so that < ((P)) > and < SLAVE > are displayed on the LCD panel.
- 2 The backlight now turns orange to indicate Slave Mode R2.

2. Setting Master Unit's Flash Mode

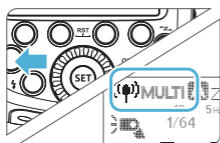
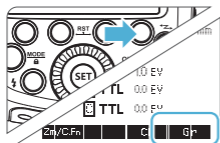

- 1 Press Function Button 4 < Gr > to choose the group from M/A/B/C. Then, press Function Button 3 < MODE > so that the master unit can work in OFF/TTL/M flash mode. Choose one of them as the flash mode of master unit.
- 2 Press < MODE > button to switch to Multi mode.

3. Setting the Communication Channel

If there are other wireless flash systems nearby, you can change the channel IDs to prevent signal interference. The channel IDs of the master unit and the slave unit(s) must be set to the same values.

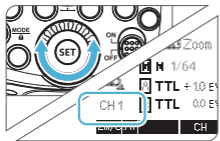
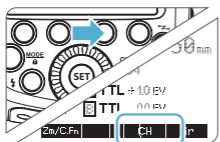

- 1 Press Function Button 3 < CH > and turn the Select Dial to choose a channel ID from 1 to 32
- 2 Press the < SET > button to confirm.

4. TTL: Fully Automatic Wireless Flash Shooting Autoflash Shooting with One Slave Unit

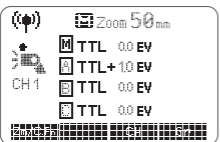

- 1 Master Unit Setting
 - Attach a Zoom Fujifilm flash on the camera and set it as the master unit. (Page 11)
 - M/A/B/C can be set as TTL mode independently.



- 2 Slave Unit Setting**
- Set the other camera flash as the wireless slave unit. (Page 12)
 - The slave unit can be set as A/B/C.

- 3 Check the communication channel**
- Set the master unit and slave unit(s) to the same channel. (Page 12)

- 4 Position the camera and flashes**
- Position the camera and flashes as the picture suggests. (Page 15)

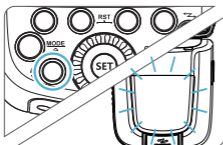

- 5 Check that the flash is ready**
- Check that the master flash ready indicator is illuminated.
 - When the slave flash ready indicator is ready, the AF-assist beam panel area will blink at 1 second intervals.

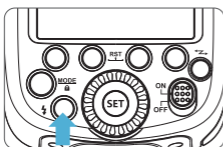

- 6 Check the flash operation**
- Press the master unit's Test Button < ⚡ >.
 - The slave unit will fire. If not, check whether the slave unit is set in the right position.



The slave unit might be out of order or fire an unwanted flash due to the nearby fluorescent lamp or computer screen influence.



- If the slave unit's auto power off function is triggered, press the master unit's test button to power the flash on. Please note that test firing is unavailable during the camera's regular operation.
- The effective time of slave auto power off is changeable in the Custom Functions. (C.Fn-Sv APOT/ Page 18)
- The auto AF-assist transmitter can be set not to blink after the slave unit's flash ready indicator is illuminated in the Custom Functions. (C.Fn-AF/ Page 18)

Using Fully Automatic Wireless Flash

The FEC and other flash settings that are set on the master unit will be transmitted to the slave unit automatically. The slave unit does not need any input for settings when they are set on the master flash. Use the same method of compensation for wireless slave units as with normal flash shooting.

- See Flash Exposure Compensation < ⚡ ± > / Page 7

Multiple Master Flashes

It is possible to use two or more master units. Each master will transmit to the slave as each camera is fired. Even though several cameras have master flashes attached, the single linked slave will respond to the setting of each master flash.

5. M: Wireless Flash Shooting with Manual Flash

Advanced multiple wireless shooting, using manual flash, can be achieved by designating Groups. You can shoot with a different flash output setting for each slave unit firing group. All of the setting parameters are made on the master unit.

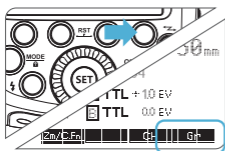

1 **Setting the flash mode to <M>**
Press Function Button 4 < Gr >> < Gr > to choose groups. Then, press Function Button 3 < MODE > to set the flash to M mode.

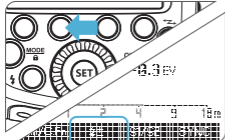

2 **Setting flash output**
When choosing the state of the group, press Function Button 2 < ± > to set the power output. Turn the Select Dial to set the flash output of the groups. Press the <SET> button to confirm.

3 **Taking the picture**
Each group fires at the set flash ratio.

6. Multi: Manual Wireless Flash Shooting

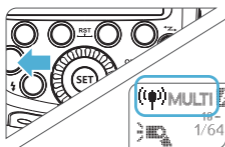

1 **Setting <Multi> Stroboscopic Flash.**

- Press <MODE> button so that <MULTI> is displayed.
- Setting the stroboscopic flash.

The flash can be set on wireless R2 radio transmission to advanced wireless multi-flash stroboscopic lighting in the same way as ordinary TTL auto flash shooting, using MULTI as the Mode option in separate groups, as a master or slave.

All of the selection options are the same as in normal non-wireless operation as previously described. Basic subject and light position and operating range are the same, as long as the main control unit is set to <TTL> for wireless automatic flash shooting.

Positioning and operating range (example of wireless flash shooting)

Autoflash Setup with One Slave Unit

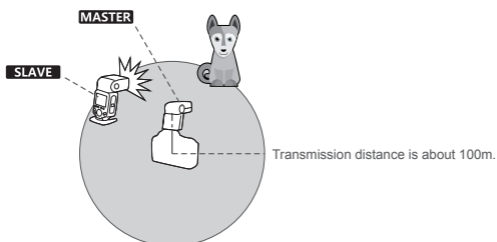

- Use the supplied mini stand to position the slave unit.
- Before shooting, perform a test flash and test shooting.
- The transmission distance might be shorter depending on the conditions such as positioning of slave units, the surrounding environment and weather conditions.

Wireless Multiple Flash Unit Setup

You can divide the slave units into two or three groups and perform TTL autoflash while changing the flash ratio (factor). In addition, you can set and shoot with a different flash mode for each firing group, for up to 5 groups.

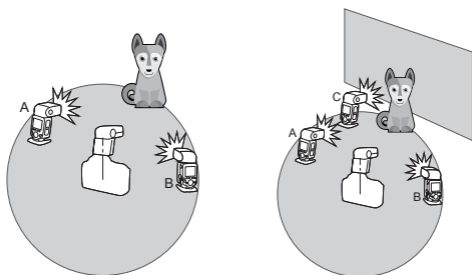

Other Wireless Control Features

R1 Wireless Control Function

The flash unit is designed with a R1 Wireless Control Port so that you can wirelessly adjust the power level of the flash and the flash triggering from a non R2 transmitter.

To control the flash wirelessly, you need a Flashpoint R1 Transmitter and Receiver Set for the Zoom Flash (FT-16S) PPLFSMZLRR.

Insert the receiver into the Wireless Control Port on the flash and insert the transmitter into the camera hot shoe. Settings made on the hotshoe-mounted transmitter will be wirelessly communicated to the flash. Then you can press the camera shutter release button to trigger the flash. You can also hold the transmitter in your hand to control your off-camera flash.

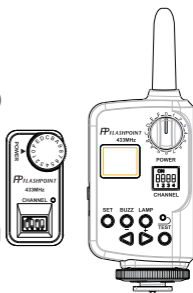

For full instructions on the use of R1 series remote control, see its user manual.

Sync Triggering

The Sync Cord Jack is a $\Phi 3.5\text{mm}$ plug. Insert a trigger plug into the socket and the flash will be fired synchronously with the camera's PC socket.

Bounce Flash

By pointing the flash head toward a wall or ceiling, the flash will bounce off the surface before illuminating the subject. This can soften shadows behind the subject for a more natural-looking shot. This is called bounce flash.

To set the bounce direction, hold the flash head and turn it to the desired angle.

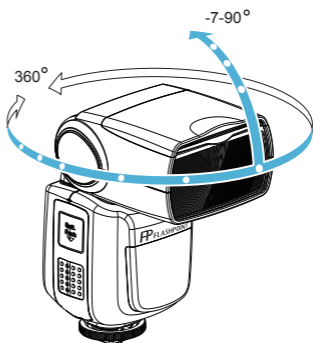

is



- If the wall or ceiling is too far away, the bounced flash might be too weak and result in underexposure.
- The wall or ceiling should be a plain, white color with good reflectance. If the bounce surface is not white, a color cast may appear in the picture.

Creating a Catchlight

With the catch light panel, you can create a catchlight in the subject's eyes to add life to the facial expression.

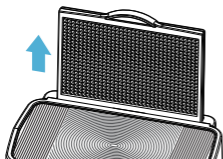

1

Point the flash head upward to 90°.

2

Pull out the wide angle diffusion panel. The catch light panel will come out at the same time.

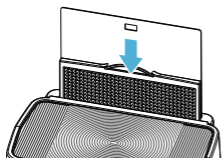

3

Push the wide angle diffusion panel back in.

- Push in only the wide angle diffusion panel.
- Follow the same procedures as for bounce flash.



- Point the flash head straight ahead and then upward to 90°. The catch light will not appear if you swing the flash head left or right.
- For best catchlight effect, stay about 1.5m/4.9ft away from the subject.

ZOOM: Setting Flash Coverage and Using the Wide Panel

The flash coverage can be set automatically or manually. It can be set to match the lens focal length from 10 mm to 100mm (4/3 system).

Also, with the built-in wide panel, the flash coverage can be expanded for 7mm wide-angle lenses.

Choose 4/3 or 135 system in the Custom Function, C.Fn-ZOOM.

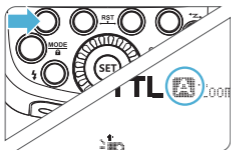

In Manual Zoom mode, press the <ZOOM/C.FN> button.

- Turn the Select Dial to change the flash coverage.
- If <A> is displayed, the flash coverage will be set automatically.



If you set the flash coverage manually, make sure it covers the lens focal length so that the picture will not have a dark periphery.

Auto Focus Assist Beam

In poorly-lit or low-contrast shooting environments, the built-in auto focus assist beam will automatically light on to make it easier for autofocus. The beam will light up only when autofocus is difficult and get out as soon as the autofocus becomes correct. If you want to turn off the auto focus assist beam, set the "AF" to "OFF" on the Custom Function C.Fn settings.

□ If you find the auto focus assist beam does not light up, this is because the camera has got a correct autofocus.

□ The auto focus assist beam can only start up in the slower than 1/200s shutter speeds.

Using the Wide Panel

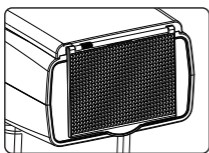

Pull out the wide panel and place it over the flash head as shown. The flash coverage will then be extended to 7 mm.

- The catchlight panel will come out at the same time. Push the catchlight panel back into place.
- The <ZOOM/C.FN> button will not work.

Low Battery Warning

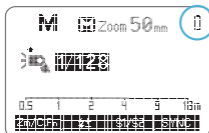

If the battery power is low, < > will appear and blink on the LCD panel. Please replace the batteries immediately.

C.Fn: Setting Custom Functions

The following table lists the available custom functions of this flash.

C.Fn Custom Functions			
Custom Function Signs	Function	Setting No.	Settings & Description
m/ft	Distance indicator	m	m
		ft	feet
APO	Auto power off	ON	ON
		OFF	OFF
AF	AF-assist beam	ON	ON
		OFF	OFF
Sv APOT	Slave auto power off timer	60min	60min
		30min	30min
BEEP	Beeper	ON	ON
		OFF	OFF
LIGHT	Backlighting time	12sec	Off in 12 sec.
		OFF	Always off
		ON	Always lighting
LCD	LCD contrast ratio	0~9	10 levels
ZOOM	ZOOM display format	APS	APS system
		135	135 system

1. Press <Zm/C.Fn> Backlight/Custom Setting Button for 2 seconds or longer until C.Fn menu is displayed. The "Ver x.x" in the top right corner refers to the software version.
2. Select the Custom Function No.
 - Turn the Select Dial to select the Custom Function.
3. Change the Setting.
 - Press <SET> button and the Setting No. blinks.
 - Turn the Select Dial to set the desired number. Pressing <SET> button will confirm the settings.
 - After you set the Custom Functions and press <MODE> button, the flash will be ready to shoot.
4. While in the C.Fn menus, a long press on the "Clear" button for 2 seconds, until "OK" is displayed on the panel, the values in C.Fn can be reset to the default values.

Firmware Upgrade

This flash supports firmware upgrade through the USB port. Update information will be released on our official website.



USB connection cord is not included in this product. The USB port is a standard Micro USB socket.

Protection Functions

1. Overheating - Temperature Protection

- To avoid overheating and deteriorating the flash head, do not fire more than 30 continuous flashes in fast succession at 1/1 full power. After 30 continuous flashes, allow a rest time of at least 10 minutes.
- If you fire more than 30 continuous flashes and then fire more flashes in short intervals, the inner over-temperature protection function may be activated and make the recycling time over 10 seconds. If this occurs, allow a rest time of about 10 minutes, and the flash unit will then return to normal.
- When the over-heat protection is started,  is shown on the LCD display.

Number of flashes that will activate over-temperature protection:

Power Output Level	Number of Flashes
1/1	30
1/2 +0.7	40
1/2 +0.3	50
1/2	60
1/4(+0.3,+0.7)	100
1/8(+0.3,+0.7)	200
1/16(+0.3,+0.7)	300
1/32(+0.3,+0.7)	500
1/64(+0.3,+0.7)	1000
1/128(+0.3,+0.7)	

Number of flashes that will activate over-temperature protection in high-speed sync triggering mode:

Power Output	Times
1/1	15
1/2(+0.3,+0.7);	20
1/4(+0.3,+0.7)	30
1/8(+0.3,+0.7);	
1/16(+0.3,+0.7)	40
1/32(+0.3,+0.7);	
1/64(+0.3,+0.7);	50
1/128(+0.3,+0.7);	

2. Other Protections

The system provides real-time protection to secure the device and your safety. The following lists prompts for your reference:

Prompts on LCD Panel	Meaning
E1	A failure occurs on the recycling system so that the flash cannot fire. Please restart the flash unit. If the problem still exists, please send this product to a maintenance center.
E2	The system gets excessive heat. Please allow a rest time of 10 minutes.
E3	The voltage on two outlets of the flash tube is too high. Please send this product to a maintenance center.
E9	There are some errors occurred during the upgrading process. Please using the correct firmware upgrade method.

Compatible Camera Models

Fuji cameras are divided into three kinds according to their different controlling ways to camera flash:

A	X-Pro2, X-T20, X-T2, X-T1
B	X-Pro1, X-T10, X-E1, X-A3
C	X100F, X100T

Compatible camera models & functions support

camera	Camera Flash							2.4G Wireless Control							AF-assist Beam
	TTL Flash			M Manual Flash				TTL Flash			M Manual Flash				
	Standard	REAR	HSS(FP)	Standard	REAR	HSS(FP)	Multi Stroboscopic Flash	Standard	REAR	HSS(FP)	Standard	REAR	HSS(FP)	Multi Stroboscopic Flash	
A	√	√	√	√	√	√	√	√	√	√	√	√	√	√	√
B	√	-	--	√	--	-	√	√	-	--	√	-	-	√	--
C	√	√	√	√	√	√	√	√	√	--	√	√	-	√	--

This table only lists the tested camera models, not all Fujifilm cameras. For the compatibility of other camera models, a self-test is recommended.

- Rights to modify this table are retained.



- X 100T does not have a second curtain sync (REAR) function.
- The AF assist beam will light up when the shutter is at speeds lower than 200.

Maintenance

- Shut down the device immediately should abnormal operation be detected.
- Avoid sudden impacts, and the product should be dusted regularly.
- It is normal for the flash tube to be warm when in use. Avoid continuous flashes if possible.
- Maintenance of the flash must be performed by an authorized maintenance department which can provide original accessories.
- This product, except consumables e.g. flash tube, is supported with a one-year warranty.
- Unauthorized service will void the warranty.
- If the product had failures or was wet, do not use it until it is repaired by professionals.
- Changes made to the specifications or designs may not be reflected in this manual.

Troubleshooting

If there is a problem, refer to this Troubleshooting Guide.

The Camera Flash cannot be charged.

- The battery is installed in the wrong direction.
- Install the battery in the correct direction.
- The camera flash's internal battery is exhausted.
- If < > appears and blinks on the LCD panel, replace the batteries immediately.

The Camera Flash does not fire.

- The camera flash is not attached securely to the camera.
- Attach the camera's mounting foot securely to the camera.
- The electrical contacts of the Camera Flash and camera are dirty.
- Clean the contacts.

The power turns off by itself.

- After 90 seconds of idle operation, auto power off took effect if the flash is set as master.
- Press the shutter button halfway or press any flash button to wake up.
- After 60 minutes (or 30 minutes) of idle operation, the flash unit will enter sleep mode if it is set as slave.
- Press any flash button to wake up.

Auto zoom does not work.

- The camera flash is not attached securely to the camera.
- Attach the camera flash's mounting foot to the camera.

The flash exposure is underexposed or overexposed.

- You used high-speed sync.
- With high-speed sync, the effective flash range will be shorter. Make sure the subject is within the effective flash range displayed.
- You used Manual Flash mode.
- Set the flash mode to TTL or modify the flash output.

Photos have dark corners or only parts of the target subject are illuminated.

- The focal length of lens exceeds the flash coverage.
- Check the flash coverage you set. This flash unit has the flash coverage between 20 and 200mm, which fits 135/35mm format cameras; between 10 and 100mm, for 4/3 format cameras Pull the wide panel out to extend the flash coverage to 7mm (4/3).

Technical Data

Model	FPLFSMZFU
• Type	
Compatible Cameras	Fujifilm cameras (refer to compatible camera models)
Guide No. (1/1 output @ 200mm)	60 (m ISO 100) 190 (feet ISO 100)
Flash Coverage	20 to 200mm (135 system) or 14 to 133mm (APS) • Auto zoom (Flash coverage set automatically to match the lens focal length and image size) • Manual zoom • Swinging/tilting flash head (bounce flash): 0 to 360° horizontally and -7° to 90° vertically
Flash Duration	1/300 to 1/20000 seconds
• Exposure Control	
Exposure control system	TTL autoflash and manual flash
Flash exposure compensation (FEC)	Manual. FEB: ±3 stops in 1/3 stop increments (Manual FEC can be combined.)
Sync mode	High-speed sync (up to 1/8000 seconds), first-curtain sync, and second-curtain sync
Multi flash	Provided (up to 100 times, 200Hz)
• Wireless Flash (Optical transmission and 2.4G transmission)	
Wireless flash function	Master, Slave, Off
Controllable slave groups	3 (A, B and C)
Transmission range (approx.)	328ft / 100m
Channels	32 (1~32)
Slave-ready indicator	Two red indicators blink
• Auto Focus Assist Beam	
Effective range (approx.)	Center: 0.6~10m / 2.0~32.8 feet Periphery: 0.6~5m / 2.0~16.4 feet
• Power Supply	
AA batteries	Ni-MH batteries (recommended) or 4x LR6 alkaline
Recycle time	Approx. 0.1-2.6 seconds (eneloop Ni-MH brand batteries). Red LED indicator will light up when the flash is ready.
Full power flashes	Approx. 230 (2500mA Ni-MH batteries)
Power saving	Power off automatically after approx. 90 seconds of idle operation. (60 minutes if set as slave)
• Sync Triggering Mode	Hotshoe, 3.5mm sync line, Wireless control port
• Color Temperature	5600±200k
• Dimensions	
W x H x D	2.5 x 3.0 x 7.5 in / 64 x 76 x 190 mm
Weight without battery	14.5 oz / 410g

FCC Warning

Any changes or modifications not expressly approved by the party responsible for compliance could void the user's authority to operate the equipment. This device complies with part 15 of the FCC Rules.

Operation is subject to the following two conditions: (1) This device may not cause harmful interference, and (2) this device must accept any interference received, including interference that may cause undesired operation.

FCC Radiation Exposure Statement:

This equipment complies with FCC radiation exposure limits set forth for an uncontrolled environment. This transmitter must not be collocated or operating in conjunction with any other antenna or transmitter.

For assistance, you can always email Brands@Adorama.com

