

# FP FLASHPOINT



Zoom Li-ion  
TTL Flash   
for Nikon

FPLFSMZLNKV2

## Thank you for choosing Flashpoint!

The new Flashpoint Zoom Li-on TTL Speedlight for Nikon with Integrated R2 Radio Transceiver is a hotshoe speedlight which is fully compatible with the Nikon CLS TTL system. It delivers the benefits of an external battery pack without the irritation of cables, thanks to the Zoom Li-on's generous internal interchangeable 11.1 volt Lithium Ion battery. The incredible amount of power contained in these compact and lightweight units as well as their integrated functions and features make them the first choice of professional photographers. If you have any questions or concerns, please feel free to contact us at [Brands@Adorama.com](mailto:Brands@Adorama.com)

## Features

- Extremely Powerful Flash with a GN of 127
- Uses an Advanced Li-Ion Polymer Battery Which Has Amazing Power, Recycle Time, and Life Expectancy
- Approximately 650 Full Power Flashes Per Charge
- Complete Compatibility with The Nikon CLS E-TTL System
- Fully Compatible with All On Camera i-TTL Controls Including Automatic TTL Exposure Control, Exposure Bias, Bracketing, Second Curtain Sync, HSS, EXIF Recording, Modeling Flash, and Flash Exposure Lock
- Optical i-TTL CLS Communication with Nikon Flashes as a Master or Slave
- Manual Control of Three Different Wireless Groups by Using the Nikon CLS Optical System
- Remote i-TTL and Manual Power Control with the Integrated R2 Radio System's Built In Transmitter and Receiver
- Industry benchmark range and interference avoidance with the new INTEGRATED 2.4 GHz R2 Radio System
- Zooming Head for Even Coverage with automatic zoom or manual control
- HSS for Shutter Speeds Up To 1/8000 Second
- Regular and Intelligent Optical Slave Modes
- Backwards Compatible with The Flashpoint R1 Radio Control System for Manual Output Control and Triggering
- 360 degree rotation and 90+ degree tilt
- Stable color temperature at 5600±200K over the entire power range
- Backlit Matrix LCD
- Multipurpose Buttons with Digital Marking for Faster Navigation
- Perfect for On and Off Camera Use
- Laser AF Assist Lamp with Crisscross Pattern for Instant Autofocus Even In Complete Dark On Low Contrast Surfaces
- 1 Year Warranty

## For Your Safety

- Always keep this product dry.  
Do not use in rain or in damp conditions.
- Do not use any power supply other than the included one to charge the battery.
- Do not charge the battery for more than 12 hours
- This product contains high-voltage electronic parts. Touching the high-voltage circuit inside it may result in electric shock. Do not disassemble. Should repairs become necessary, this product must be sent to an authorized maintenance center.
- Stop using this product if it breaks open due to internal shifting, falling or strong impact. STRONG electric shock may occur if you touch the components inside it. You might DIE. Don't risk it. Reincarnation is not covered by the warranty.
- Do not fire the flash directly into the eyes (especially those of babies and pets) within short distances. Otherwise visual impairment may occur. When taking pictures for babies, keep the flash unit at least 1 meter (3.3 feet) away from them. Using bounce flash to reduce light intensity is also recommended. Plus it will make them look cuter. Because it creates softer light, and larger catchlights in the eyes. And makes them look more angelic. Which is good. Cause they are babies. They are SUPPOSED to look angelic! Also you won't get hard shadows from that ridiculous gigantic bow they decided to stick on the baby's head if you bounce your light.
- Do not use the flash unit in the presence of flammable gases, chemicals and other similar materials. In certain circumstances, these materials may be sensitive to the strong light emitting from this flash unit and fire may result. A whole new meaning to "Flashpoint".
- Do not leave or store the flash unit if the ambient temperature reads over 50°C (e.g. in automobile in the sun). Otherwise the electronic parts may be damaged.
- Do not insert metal parts into any lighting equipment.
- Do not touch the electrical contacts on the flash or battery or contact them with any conductive materials.
- This flash has an over-heat protection circuit, rapid continuous firing will cause the flash to slow operation and trigger a "cool down" period. After this period, the flash will resume normal operation. You may also reboot the flash by cycling the power off and then on.
- Do not use selective coloring
- Do not use the flash to support other equipment. For example, do not lift your camera by the flash.
- The flash has a locking pin to ensure secure operation. To avoid damage, completely unscrew the locking ring before removing the flash.
- The battery should slide smoothly into the flash. If it does not, remove it, check alignment, and check for obstructions. Do not force the battery.
- Do not store illegal substances in the flash's battery compartment.
- In case of abnormal function, sparks, excessive heat, flames or smoke, immediately power off the unit and disconnect the battery if safely possible. Have it checked by an authorized technician.

## Name of Parts

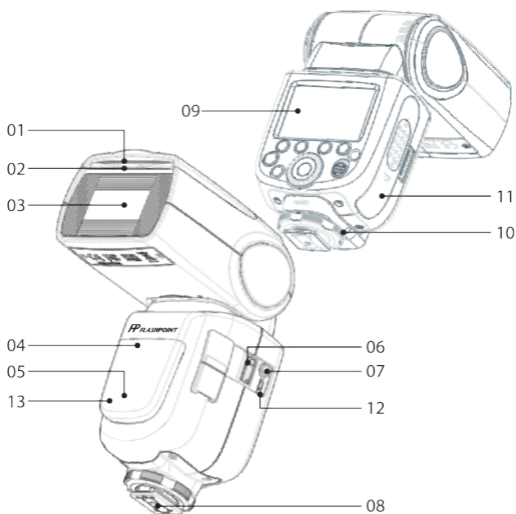

### Body

- |                                     |                                    |
|-------------------------------------|------------------------------------|
| 01. Retractable Bounce Card         | 08. Hotshoe                        |
| 02. Retractable Wide Angle Diffuser | 09. Dot-matrix LCD Panel           |
| 03. Flash Head                      | 10. Lock Ring                      |
| 04. Optical Control Sensor          | 11. Battery Compartment            |
| 05. Focus Assist Beam               | 12. USB Port for Firmware Upgrades |
| 06. R1 Wireless Control Port        | 13. Slave Flash Ready Indicator    |
| 07. Sync Cord Jack                  |                                    |

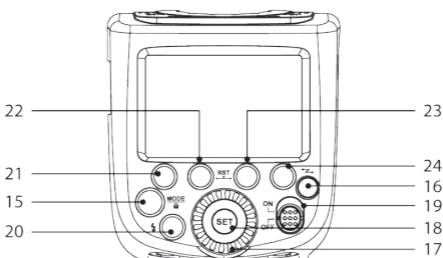

### Control Panel

- |   |  |
|---|--|
| 15. < <b>MODE</b> > Mode Selection Button / Lock Button | 20. < <b>⚡</b> > Test Button / Flash Ready Indicator |
| 16. < <b>↔</b> > Wireless Selection Button              | 21. Function Button 1                                |
| 17. Select Dial   | 22. Function Button 2                                |
| 18. < <b>SET</b> > Set Button                           | 23. Function Button 3                                |
| 19. ON / OFF Power Switch                               | 24. Function Button 4                                |

## LCD Panel

### (1) i-TTL Autoflash

**Zoom** : Zoom display

**A** : Automatic

**M** : Manual

**i-TTL** : i-TTL autoflash

Focus length

**SH** : High-speed sync

**SC** : Second curtain sync

**EV** : Flash exposure compensation

Flash exposure compensation amount

**F** : Aperture

Effective flash range

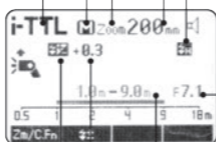

- The display will only show the settings currently applied.
- The functions displayed above buttons 1 to 4, such as **SYNC** and **±**, change according to settings' status.
- When a button or dial is operated, the LCD panel is illuminated.

### (2) M Manual Flash

**M** : Manual flash

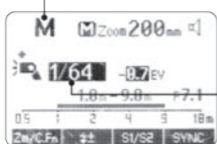

Manual flash output

### (3) Multi Flash

**RPT** : Stroboscopic flash

Number of flashes

Flash frequency (Hz=Flashes per Second)

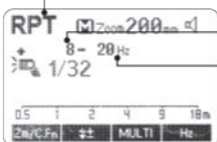

#### (4) Radio Transmission Shooting/Optical Transmission Shooting

##### • Master Unit

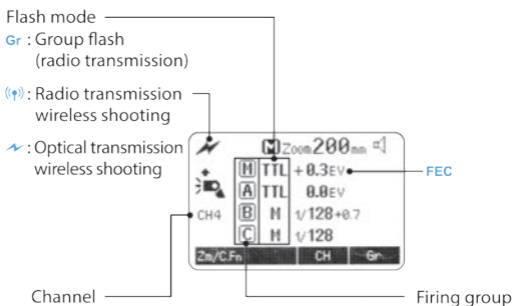

##### • Slave Unit

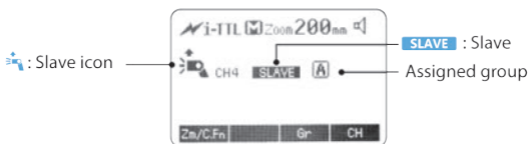

##### • Included Accessories

1. Flash Unit
2. Mini Stand
3. Protective Case
4. Instruction Manual
5. Li-ion Battery Pack
6. Battery Charger with Cable

##### • Accessories

R2 Radios



R1 Radios



Flashpoint Grid for Speedlight FPLFSMX02



Flashpoint Flash Diffuser FAFD60



Hexapop/Parapop rapid deployment Softboxes



Flashpoint Speedlight Reflector FPLFSMX01



## Attaching to a Camera

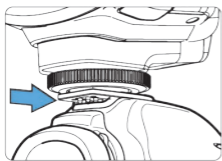

- 1 Attach the Camera Flash.**  
Slip the camera flash's mounting foot into the camera's hotshoe all the way.

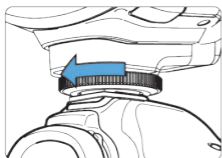

- 2 Secure the Camera Flash.**  
Rotate the lock ring on the mounting foot until it is secure.

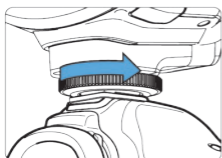

- 3 Detach the Camera Flash.**  
Rotate the lock ring on the mounting foot until it is fully loosened.

## Power Management

Use ON/OFF Power Switch to power the flash unit on or off. Turn off the unit if it will not be used for an extended period of time. Set as a master flash, it will turn the power off automatically after approx. 90 seconds of idle use. Pressing the camera shutter halfway or pressing any flash button will wake up the flash unit. Set as a slave flash, it will enter sleep mode after a certain period (adjustable, 60 minutes by default) of idle use. Pressing any flash button will wake it up.



**C.Fn** Disabling Auto Power Off function is recommended when the flash is used off camera. See the [Custom Function Menu](#) section.

**C.Fn** Slave Auto Power Off Timer is set to 60 minutes by default. Another option "30 minutes" is available. See the [Custom Function Menu](#) section.

# Battery Features

1. This flash unit uses an advanced Li-ion polymer battery which has amazing power and life expectancy.
2. It has several safety features, such as circuitry to protect against overcharge, over discharge, outputting too much power, and short circuit.
3. It takes only 2.5 hours to fully charge the battery by using the standard battery charger (included).

# Battery Warnings

1. Do not short circuit.
2. Do not expose to rain or immerse into water. This battery is not water proof.
3. Keep out of reach of children.
4. Do not leave the battery in the charger for more than 12 hours.
5. Store in dry, cool, ventilated places.
6. Do not put near or into fire.
7. Batteries should be disposed according to local regulations.
8. If the battery was not used for over 3 months, please charge fully before use.

## Loading and unloading the battery

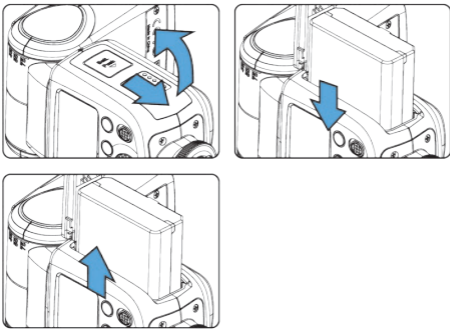

To load the battery, line up the shape of the battery with the battery compartment (it can only fit one way) and slide it into the flash until the white retaining snap clicks into place. To remove the battery, slide aside the white retaining snap. The battery should pop out of the unit on its own.

Battery Level Indication	Meaning
	Full
	Middle
	Low
Blinking	Battery power will be empty and need to be charged immediately

Note: There is a battery level indicator on the LCD screen to inform you of the current battery level. Please keep an eye on it.



## Flash Mode – i-TTL Autoflash

This flash has three flash modes: **i-TTL**, Manual (**M**), and **RPT** (Stroboscopic). In **i-TTL** mode, the camera and the flash will work together to calculate the correct exposure for the subject and the background. In this mode, multiple TTL functions are available: FEC, HSS, second curtain sync, modeling flash, etc.

\* Press **< MODE >** Mode Selection Button and three flash modes will display on the LCD panel one by one with each press.

### i-TTL Mode

Press **< MODE >** Mode Selection Button to enter i-TTL(Automatic) mode.



- Press the camera release button halfway to focus. The aperture and effective flash range will be displayed in the viewfinder.
- When the shutter button is fully pressed, the flash will fire a pre-flash that the camera will use to calculate exposure and flash output the instant before the photo is taken.

### FEC: Flash Exposure Compensation

With FEC function, this flash can bias the flash output from -3 to +3 in 1/3rd stops. It is useful in situations where minor adjusting of the TTL system is needed based on the environment.

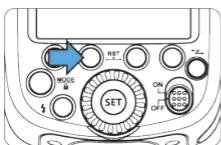
#### Setting FEC:



- 1 Press Function Button 2 **<  >**. The icon **<  >** and flash exposure compensation amount will be highlighted on the LCD panel.

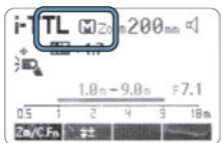

- 2 Set the flash exposure bracketing amount.
  - Turn the Select Dial to set the amount.
  - "0.3" means 1/3 stop.
  - "0.7" means 2/3 stop.
  - To cancel the flash exposure compensation, set the amount to "+0".

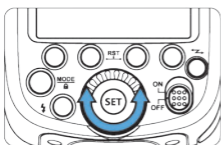



- 3 Press **< SET >** button again to confirm the setting.

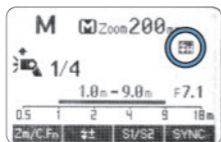

## High-Speed Sync

High Speed Sync (FP flash) enables the flash to synchronize with all camera shutter speeds. This is convenient when you want to use aperture priority for fill-flash portraits.

Select the high-speed sync icon <  >.





- Set the flash sync speed to 1/320s (Auto FP) or 1/250s (Auto FP) in the Nikon camera menu. Press the shutter button halfway. The icon <  > displayed on the flash screen means the high speed sync function is enabled on the flash.
- Turning the camera command dial can set the shutter speed to 1/250s or faster.
- To check if the FP flash function works properly, look through the shutter speed in the viewfinder. If it shows a speed of 1/250s or faster, the FP flash function is on.

- If you set a shutter speed as 1/320s (Auto FP) or 1/250s (Auto FP) in the Nikon camera setting, <  > will be displayed in the flash screen regardless of practical shutter speed.
- With high-speed sync, the faster the shutter speed, the shorter the effective flash range.
- To return to normal flash, set the flash sync speed to other options other than Auto FP. Then the icon <  > will disappear when pressing the shutter halfway.
- Stroboscopic mode cannot be set in high-speed sync mode.
- Over-heat protection may be activated after 10 consecutive high-speed sync flashes

## Second-Curtain Sync

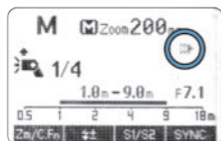
With a slow shutter speed, you can create a light train following the subject. The flash fires right before the shutter closes.



- Set the camera to Rear curtain mode and press the shutter button halfway, the flash display panel will show the second curtain sync icon <  >.
- When the camera is not set to Rear mode, pressing the shutter button halfway will not light up the icon <  > on the flash display panel.

## Flash Mode – M: Manual Flash

The flash output is adjustable from 1/1 full power to 1/128th power in 1/3rd stop increments. To obtain a correct flash exposure, use a hand-held flash meter to determine the required flash output.

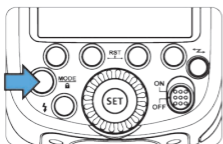

1 Press < **MODE** > button so that < **M** > is displayed.

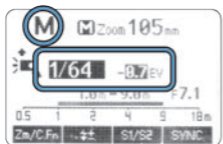

2 Turn the Select Dial to choose a desired flash output amount.

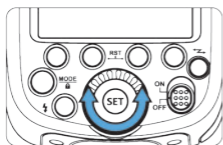

3 Press < **SET** > button again to confirm the setting.

### Flash Output Levels

The following table makes it easier to see how the display changes in terms of f/stop when you increase or decrease the flash output. For example, when you decrease the flash output to 1/2, 1/2-0.3, or 1/2-0.7, and then increase the flash output to more than 1/2, 1/2+0.3, 1/2+0.7, and 1/1 will be displayed.

Figures displayed when reducing flash output level →

1/1	1/1-0.3	1/1-0.7	1/2	1/2-0.3	1/2-0.7	1/4	.....
	1/2+0.7	1/2+0.3		1/4+0.7	1/4+0.3		.....

← Figures displayed when increasing flash output level

### Optical Slave S1

In M manual flash mode, press < **S1/S2** > button so that this flash can be triggered as an optical slave. With this function, the flash will fire simultaneously when the main flash fires. Use this mode when firing another manual powered flash, and in areas where no one else is doing flash photography.

### Intelligent Optical Slave S2

Press < **S1/S2** > button so that this flash can be triggered as an intelligent optical slave. This is useful when triggering with a TTL flash. In this mode, the flash will ignore a single “preflash” from the main flash and will only fire in response to the second, actual flash from the main unit. Use this mode when firing a TTL speedlight, and in areas where no one else is doing flash photography.

### Manual Off Camera High-speed Setting

In M manual flash mode, press < **SYNC** > button to select high-speed mode and < **H** > is displayed.

- S1 and S2 optic triggering and off camera high-speed mode are only available in M manual flash mode.

# Flash Mode – RPT: Stroboscopic Flash

With stroboscopic flash, a rapid series of flashes is fired. It can be used to capture multiple images of a moving subject in a single photograph. You can set the firing frequency (number of flashes per sec. expressed as Hz), the number of flashes, and the flash output.

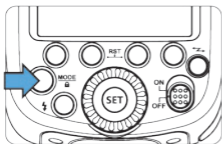

1 Press < **MODE** > button so that < **RPT** > is displayed.

2 Turn the Select Dial to choose a desired flash output.

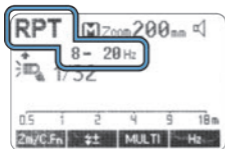

3 Set the flash frequency and flash times.

- Press Function Button 3 < **MULTI** > button to select the setting to change.
- Turn the Select Dial to set the number and press Function Button 4 < **Hz** > button again to confirm. The next item to be set will blink. (Hz=FPS)
- After you finish the setting, press < **SET** > button and all the settings will be displayed.

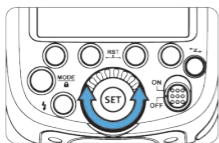

## Calculating the Shutter Speed

During stroboscopic flash, the shutter should remain open until the firing stops. Use the formula below to calculate the shutter speed and set it with the camera.

### Number of Flashes / Flash Frequency = Shutter Speed

For example, if the number of flashes is 10 and the firing frequency is 5 Hz, the shutter speed should be at least 2 seconds.

 To avoid overheating and deteriorating the flash head, do not use stroboscopic flash more than 10 times in succession. After 10 times, allow the camera flash to rest for at least 15 minutes. If you try to use the stroboscopic flash more than 10 times in succession, the firing might stop automatically to protect the flash head. If this happens, allow at least 15 minutes' rest for the camera flash.

- Stroboscopic flash is most effective with a highly reflective or light colored subject against a dark background.
- Using a tripod and a remote control is recommended.
- A flash output of 1/1 and 1/2 cannot be set for stroboscopic flash.
- Stroboscopic flash can be used with "bulb".
- If the number of flashes is displayed as "--", the firing will continue until the shutter closes or the battery is exhausted. The number of flashes will be limited as shown by the following table.

## Maximum Stroboscopic Flashes:

Flash Output \ Hz	1	2	3	4	5	6-7	8-9
1/4	7	6	5	4	4	3	3
1/8	14	14	12	10	8	6	5
1/16	30	30	30	20	20	20	10
1/32	60	60	60	50	50	40	30
1/64	90	90	90	80	80	70	60
1/128	90	90	90	90	90	90	80

Flash Output \ Hz	10	20-50	60-199			
1/4	2	2	2			
1/8	4	4	4			
1/16	8	8	8			
1/32	20	16	12			
1/64	50	30	20			
1/128	70	40	40			

## Wireless Flash Shooting: Optical Transmission

This product is compatible with Nikon Creative Lighting System (CLS). It can function as either an optical wireless master or slave flash. As a master unit, it can control Nikon speedlights e.g. SB-900 and SB-910 via optical wireless. As a slave unit, it can be controlled by optical wireless signals of Nikon speedlights e.g. SB-900 and pop-up flash commanders of Nikon cameras e.g. D7100/D7000/D800.

- You can set up three slave groups for **i-TTL** autoflash shooting. With **i-TTL** autoflash, you can easily create various lighting effects.
- Any flash settings for the slave units on the master flash in **i-TTL / Manual / RPT** mode will be automatically sent to the slave units. So the only thing you need to do is to set the slave unit for each slave group without any operation of the slave units at all during the shooting.
- This flash can work in **i-TTL / M / RPT / OFF** flash modes when set as a master or slave unit.

### Slave/Master Unit's Positioning and Operation Range

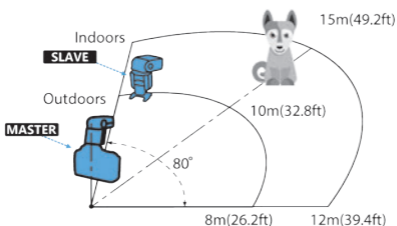

- Even with multiple slave units, the master unit can control all of them via optical wireless.
- In this user manual, “master unit” refers to the speedlight on a camera and “slave unit” will be controlled by the master unit.

## 1. Wireless Settings

You can switch between normal flash and wireless flash. For normal flash shooting, be sure to set the wireless setting to OFF.

### Master Unit Setting

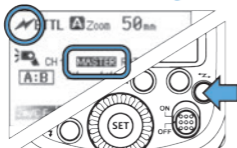

Press **< RPT >** button so that **< RPT >** and MASTER is displayed on the LCD panel.

If **< RPT >** is displayed, it means RPT mode is ON.

The backlight turns green now.

### Slave Unit Setting

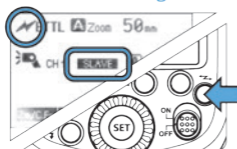

Press **< RPT >** button again so that **< RPT >** and **< SLAVE >** are displayed on the LCD panel.

The backlight turns orange now.

## 2. Setting Master Unit's Flash Mode

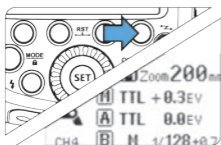

- 1 Press Function **Button 4** **< Gr >** to choose the “M” group from M/A/B/C. Then, press Function **Button 3** **< MODE >** so that the master unit can work in OFF / i-TTL / M flash mode. Choose one of them as the flash mode of master unit.

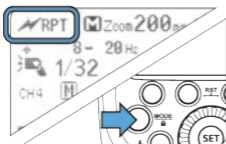

- 2 Press the “MODE/Lock” button if you want to change to RPT mode.

## 3. Setting the Communication Channel

If there are other wireless flash systems nearby, you can change the channel IDs to prevent signal interference. The channel IDs of the master unit and the slave unit(s) must be the same.



- 1 Press Function **Button 3** **< CH >** and turn the Select Dial to choose a channel ID from 1 to 4.

- 2 Press the **< SET >** button to confirm.

## 4. i-TTL: Fully Automatic Wireless Flash Shooting

### Using Automatic Wireless Flash with a Single Slave Unit

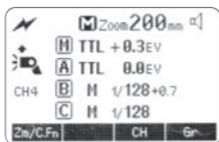

#### 1 Master Unit setting

- Attach a Flashpoint Zoom TTL flash on the camera and set it as the master Unit.
- M/A/B/C can be set as TTL mode independently.



#### 2 Slave Unit setting

- Set the other camera flash as the wireless slave Unit.
- The slave unit can be set as group A/B/C.

#### 3 Check the communication channel

- If the master unit and slave unit(s) are set to a different channel, set them to the same channel.

#### 4 Position the camera and flashes

- Position the camera and flashes as the picture shows.

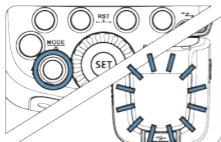

#### 5 Check that the flash is ready.

- Check that the master flash ready indicator is illuminated.
- When the slave flash indicator is ready, the AF-assist beam lighting area will blink at 1 second intervals.

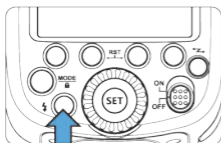

#### 6 Check the flash operation.

- Press the master unit's Test Button < lightning bolt >.
- The slave unit will fire. If not, adjust the slave unit's sensor's angle toward the master unit and distance from the master unit.



The slave unit might be out of order or fire an unwanted flash due to the nearby fluorescent lamp or computer screen.



- If the slave unit's auto power off function is engaged, press the master unit's test button to power it on. Please note that test firing is unavailable during the camera's metering time.
- The effective time of slave auto power off is adjustable. See the Custom Menu section.
- By making some settings, the auto AF-assist transmitter will not blink after the slave unit's flash ready indicator is lightened.

## Using Multiple Master Units

By preparing several cameras with master unit flashes attached, cameras can be changed during shooting while keeping the same lighting source .

### 5. M: Wireless Flash Shooting with Manual Flash

You can shoot with a different flash output setting for each slave unit (firing group). Set all parameters on the master unit.

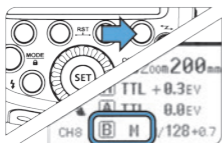

#### 1 Setting the flash mode to <M>.

- Press Function **Button 4** < **Gr** > to choose groups. Then, press Function **Button 3** < **MODE** > to set the flash to M mode.

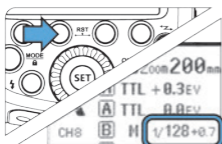

#### 2 Setting flash output.

- Press Function **Button 2** < **±** >. Turn the Select Dial to set the flash output of the groups. Press the < **SET** > button to confirm.

#### 3 Taking the picture.

- Each group fires at the set flash power.

### 6. RPT: Wireless Flash Shooting with Manual Flash

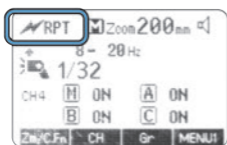

#### Setting < RPT > stroboscopic flash.

- Press < **MODE** > button so that < **RPT** > is displayed.
- Set the stroboscopic flash.



The firing frequency of stroboscopic flash during optical transmission wireless shooting can be set from 1Hz to 100 Hz (settings from 250 Hz to 500 Hz are not available).



# Wireless Flash Shooting: Radio (2.4G) Transmission

Using a flash with a radio transmission wireless shooting makes it easy to shoot with advanced wireless multiple flash setups, as well as i-TTL autoflash shooting.

The basic relative position and operating range are as shown in the picture. You can then perform wireless i-TTL II autoflash shooting just by setting the master unit to < i-TTL >.

## Positioning and Operation Range

- Autoflash Shooting with One Slave Unit

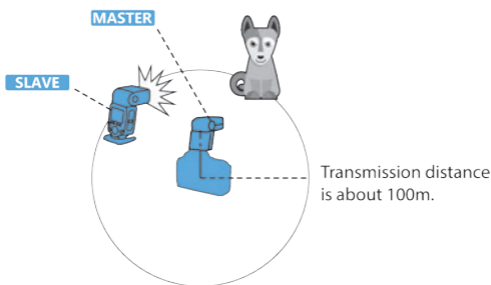

- Use the supplied mini stand to position the slave unit.
- Before shooting, perform a test flash and test exposures.
- The transmission distance might be shorter depending on factors such as positioning of slave units, interference from other signals, barriers, bodies of water, and weather conditions.

## Wireless Multiple Flash Shooting

You can divide the slave units into two or three groups and perform i-TTL autoflash while changing the flash ratio. In addition, you can set and shoot with a different flash mode for each firing group, for up to 3 groups.

- Auto Shooting with Two Slave Groups

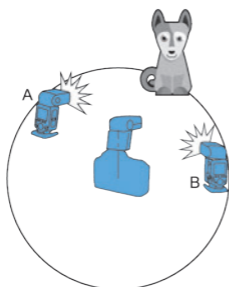

- Auto Shooting with Three Slave Groups

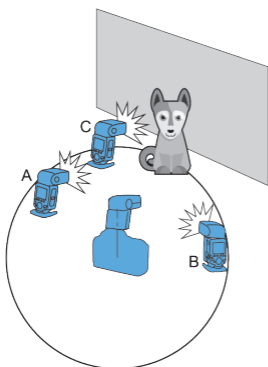

Wireless shooting using radio transmission has advantages over wireless shooting using optical transmission, such as being less affected by obstacles, and not having to point the slave unit's wireless sensor toward the master unit. The main functional differences are as follows:

Function	Radio Transmission	Optical Transmission
Distance	100m	15m
Channel	1~32	1~4
Signal Interference	Hard	Easy

## Other Features

### R1 Wireless Control Function

The flash unit is designed with a R1 Wireless Control Port so that you can wirelessly adjust the power level of the flash and the flash triggering.

To control the flash wirelessly, you need a R1 remote control set (Transmitter and Receiver). Insert the receiver into the Wireless Control Port on the flash and insert the transmitter into the camera hot shoe.

Settings made on the hotshoe-mounted transmitter will be wirelessly communicated to the flash. Then you can press the camera shutter release button to trigger the flash. You can also hold the transmitter in your hand to control your off camera flash.

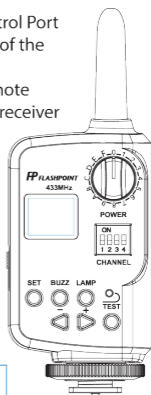
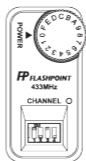

For full instructions on the use of R1 series remote control, see its user manual.

## Other Triggering Methods

### Sync Triggering

The Sync Cord Jack is a  $\Phi 3.5$ mm plug. Insert a trigger plug here and the flash will be fired simultaneously with the camera shutter.

## Modeling Flash

If the camera has a depth-of-field preview button, pressing it will fire the flash continuously for 1 second. This is called modeling flash. It enables you to see the shadow effects on the subject and the lighting balance. You can fire the modeling flash during wireless or normal flash shooting. This feature is also useful for annoying those around you.

- ⚠ To avoid overheating and deteriorating the flash head, do not fire the modeling flash for more than 10 consecutive times. If you fire the modeling flash 10 consecutive times, allow at least 10 minutes' break for the camera flash.

## Auto Focus Assist Beam

In poorly-lit or low-contrast shooting environments, the built-in auto focus assist beam will automatically activate to make it easier for autofocus. The beam will activate only when autofocus is difficult and turn off as soon as the autofocus is achieved.

If you want to turn off the auto focus assist beam, set the "AF" to "OFF" in the C.Fn settings.

- ℹ If you find the auto focus assist beam does not light up, this is because the camera has achieved autofocus.

Position	Effective Range
Center	0.6~10m / 2.0~32.8 feet
Periphery	0.6~5m / 2.0~16.4 feet

## Bounce Flash

By pointing the flash head toward a wall or ceiling, the flash will bounce off the surface before illuminating the subject. This can soften shadows behind the subject for a more natural-looking shot. This is called bounce flash.

To set the bounce direction, hold the flash head and turn it to the desired angle.

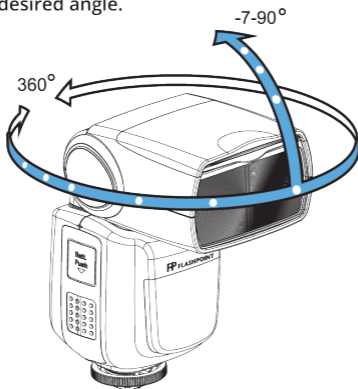



- If the wall or ceiling is too far away, the bounced flash might be too weak and result in underexposure.
- The wall or ceiling should be a plain, white color for high reflectance. If the bounce surface is not white, a color cast may appear in the picture.

## Creating a Catchlight

With the catchlight panel, you can create a catchlight in the subject's eyes to add life to the facial expression.

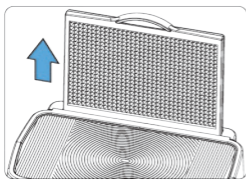

**1** Point the flash head upward to 90°.

**2** Pull out the wide angle diffusion panel. The catchlight panel will come out at the same time.

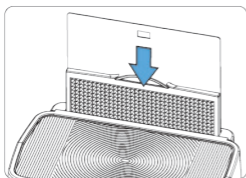

**3** Push the wide angle diffusion panel back in.

- Push in only the wide angle diffusion panel.
- Follow the same procedures as for bounce flash.



- Point the flash head straight ahead and then upward to 90°. The catchlight will not appear if you swing the flash head left or right.
- For best catchlight effect, stay 1.5m/4.9ft away from the subject.

## ZOOM: Setting the Flash Coverage and Using the Wide Angle Diffusion Panel

The flash coverage can be set automatically or manually. It can be set to match the lens focal length from 20mm to 200mm. Also, with the built-in wide angle diffusion panel, the flash coverage can be expanded for 14mm wide-angle lenses.

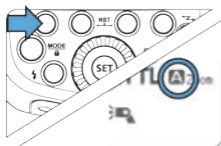

In Manual Zoom mode, press the **< ZOOM/C.FN >** button.

- Turn the Select Dial to change the flash coverage.
- If **< A >** is displayed, the flash coverage will be set automatically.



If you set the flash coverage manually, make sure it covers the lens focal length so that the picture will not have a dark periphery.

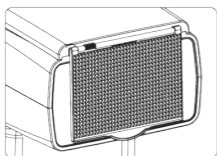

## Using the Wide Angle Diffusion Panel

Pull out the wide angle diffusion panel and place it over the flash head as shown. The flash coverage will then be expanded to 14 mm.

- The catchlight panel will come out at the same time. Push the catchlight panel back in.
- The **< ZOOM/C.FN >** button will not work.



## Low Battery Warning

If the battery power is low, **< >** will appear and blink on the LCD panel. Please replace the batteries immediately.

## C.Fn: Setting Custom Functions

The following table lists the available and unavailable custom functions of this flash.

C.Fn Custom Functions			
Custom Function Signs	Function	Setting No.	Settings & Descriptions
m/ft	Distance indicator	m	meters
		ft	feet
APO	Auto power off	ON	ON
		OFF	OFF
AF	AF-assist beam	ON	ON
		OFF	OFF
Sv APOT	Slave auto power off timer	60min	60min
		30min	30min
BEEP	Audible ready alert	ON	ON
		OFF	OFF
LIGHT	Backlighting time	12sec	Off in 12 sec.
		OFF	Always off
LCD	LCD contrast ratio	ON	Always lit
		0~9	10 levels

1. Press **< Zm/C.Fn >** Backlight/Custom Setting Button for 2 seconds or longer until C.Fn menu is displayed. The "Ver x.x" in the top-right corner refers to the software version.
2. Select the Custom Function No.
  - Turn the Select Dial to choose the Custom Functions.
3. Change the Setting.
  - Press **< SET >** button and the Setting No. blinks.
  - Turn the Select Dial to set the desired number. Pressing **< SET >**
4. In the C.Fn mode, long press the "Clear" button for 2 seconds until "OK" is displayed on the panel, which means the values in C.Fn can be reset.

# Protection Function

## 1. Over-Temperature Protection

- To avoid overheating and deteriorating the flash head, do not fire more than 20 continuous flashes in fast succession at 1/1 full power. After 20 continuous flashes, allow a rest time of at least 10 minutes.
- If you fire more than 20 continuous flashes and then fire more flashes in short intervals, the inner over-heat protection function may be activated and make the recycling time over 10 seconds. If this occurs, allow a rest time of about 10 minutes, and the flash unit will then return to normal.
- When the over-heat protection is started,  is shown on the LCD display.

Number of flashes that will activate over-temperature protection:

Power Output Level	Number of Flashes
1/1	30
1/2 +0.7	40
1/2 +0.3	50
1/2	60
1/4 ( +0.3,+0.7 )	100
1/8 ( +0.3,+0.7 )	200
1/16 ( +0.3,+0.7 )	300
1/32 ( +0.3,+0.7 )	500
1/64 ( +0.3,+0.7 )	1000
1/128 ( +0.3,+0.7 )	

Number of flashes that will activate over-temperature protection in high-speed sync triggering mode:

Power Output	Times
1/1	15
1/2 ( +0.3,+0.7 );	20
1/4 ( +0.3,+0.7 )	30
1/8 ( +0.3,+0.7 );	
1/16 ( +0.3,+0.7 )	40
1/32 ( +0.3,+0.7 );	
1/64 ( +0.3,+0.7 );	50
1/128 ( +0.3,+0.7 );	

## 2. Other Protections

The system provides real-time protection to secure the device and your safety. The following lists prompts for your reference:

Prompts on LCD Panel	Meaning
E1	A failure occurs on the recycling system so that the flash cannot fire. Please restart the flash unit. If the problem still exists, please send this product to a maintenance center.
E2	The system gets excessive heat. Please allow a rest time of 10 minutes.
E3	The voltage on two outlets of the flash tube is too high. Please send this product to a maintenance center.
E9	There are some errors occurred during the upgrading process. Please use the correct firmware upgrade method.

# Technical Data

<b>Model</b>		<b>FPLFSMZLNKV2</b>
<b>• Type</b>		
Compatible cameras	Nikon DSLR cameras (i-TTL autoflash)	
Guide no. (1/1 output @ 200mm)	127 Ft, 34 Meters @ ISO 100 200mm zoom	
Flash coverage	20 to 200mm (14mm with wide Angle Diffusion panel)	
	• Auto zoom (Flash coverage set automatically to match the lens focal length and sensor size)	
	• Manual zoom	
	• Rotating/tilting flash head (bounce flash): 0 to 360° horizontally and -7° to 90° vertically	
Flash duration	1/300 to 1/20000 second	
<b>• Exposure Control</b>		
Exposure control system	E-TTL II autoflash and manual flash	
Flash exposure compensation (FEC)	Manual, FEB: ±3 stops in 1/3 stop increments (Manual FEC and FEB can be combined.)	
Sync mode	High-speed sync (up to 1/8000 seconds), first-curtain sync, and second-curtain sync	
Stroboscopic mode	Provided (up to 90 times, 100Hz)	
<b>• Wireless Flash (Optic transmission and 2.4G transmission)</b>		
Wireless flash function	Master, Slave, Off	
Controllable slave groups	3 (A, B, and C)	
Transmission range (approx.)	Optical	Indoors: 12 to 15 m / 39.4 to 49.2 ft.
		Outdoors: 8 to 10 m / 26.2 to 32.8 ft.
	Master unit reception angle: ±40° horizontally, ±30° vertically	
	2.4G	100m
Channels	Optical	4 (1, 2, 3, and 4)
	2.4G	32 (1~32)
Slave-ready indicator	Two red blinking indicators	
Modeling flash	Fired with camera's depth-of-field preview button	
<b>• Auto Focus Assist Beam</b>		
Effective range (approx.)	Center: 0.6~10m / 2.0~32.8 feet	
	Periphery: 0.6~5m / 2.0~16.4 feet	
<b>• Power Supply</b>		
Power source	11.1V/2000mAh Li-ion polymer battery	
Recycle time	< 1.5 seconds. Red LED indicator will light up when the flash is ready.	
Full power flashes	Approx. 650	
Power saving	Power off automatically after approx. 90 seconds of idle operation. (60 minutes if set as slave)	
<b>• Sync Triggering Mode</b>	Hotshoe, 3.5mm sync line, R1 Wireless control port	
<b>• Color Temperature</b>	5600±200k	
<b>• Dimensions</b>		
W x H x D	64 x 76 x 190 mm	
Weight without battery	410g	
Weight with battery	530g	

# Troubleshooting

If there is a problem, refer to this Troubleshooting Guide.

## **The Camera Flash cannot be charged.**

- The batteries are installed in the wrong direction.  
→ Install the battery is in the correct direction.
- The camera flash's internal battery is exhausted.  
→ If  appears and blinks on the LCD panel, replace the batteries immediately.

## **The Camera Flash does not fire.**

- The camera flash is not attached securely to the camera.  
→ Attach the flash's mounting foot securely to the camera.
- The electrical contacts of the Camera Flash and camera are dirty.  
→ Clean the contacts with an eraser.

## **The power turns off by itself.**

- After 90 seconds of idle operation, auto power off takes effect if the flash is set as master.  
→ Press the shutter button halfway or press any flash button to wake up.
- After 60 minutes (or 30 minutes) of idle operation, the flash unit will enter sleep mode if it is set as slave.  
→ Press any flash button to wake up.

## **Auto zoom does not work.**

- The camera flash is not attached securely to the camera.  
→ Attach the camera flash's mounting foot to the camera.

## **The flash exposure is underexposed or overexposed.**

- You used high-speed sync.  
→ With high-speed sync, the effective flash range will be shorter. Make sure the subject is within the effective flash range displayed.
- You used Manual Flash mode.  
→ Set the flash mode to **i-TTL** or modify the flash output.

## **Photos have dark corners or only parts of the target subject are illuminated.**

- The focal length of lens is wider than the flash zoom setting.  
→ Check the flash coverage you set. This flash unit has the flash coverage between 20 and 200mm, which fits medium-format cameras. Pull the wide Angle Diffusion panel out to extend the flash coverage.



## Firmware Upgrade

This flash supports firmware upgrade through the USB port. Update information will be released on our official website.



USB connection line is not included in this product. The USB port is a standard Micro USB socket.

## Maintenance

- Shut down the device immediately should abnormal operation be detected.
- Avoid sudden impacts, and the product should be dusted regularly.
- It is normal for the flash tube to be warm when in use. Avoid continuous flashes if possible.
- Maintenance of the flash must be performed by an authorized maintenance department which can provide original accessories.
- This product, except consumables e.g. flash tube, is supported with a one-year warranty.
- Unauthorized service will void the warranty.
- If the product had failures or was wet, do not use it until it is repaired by professionals.
- Changes made to the specifications or designs may not be reflected in this manual.