

# FP FLASHPOINT



Zoom Li-on X R2  
TTL Speedlight  
for Pentax

Round Head Zoom with R2 Transceiver

FPLFSMZLXP

# Thank You for Choosing Flashpoint!

The new Flashpoint Zoom Li-on X TTL Speedlight for Pentax, with Integrated R2 Radio Transceiver is the on-camera speedlight fully compatible with the Sony TTL system that delivers a more natural circular flash spread than ordinary rectangular speedlights.

The more pleasing light performance enjoys the benefits of an ingenious internal interchangeable 7.2V/2600mAh Lithium Ion battery boasting up to 480 without the irritation of cables to an external battery pack. The incredible amount of power produced by this compact and lightweight unit, as well as their integrated functions and features, make the Zoom Li-on X TTL the select choice of pro or amateur photographer.

Beneath the new Flashpoint Zoom Li-on X R2 refined Round Head sleek design, are capabilities that develop the potential of what you can shoot. As a wireless command center for the revered R2 System or as a lone on-camera TTL flash. The round zoom head brings a fresh, even distribution of flashpower that's sure to amaze, wherever your adventure. Well thought out menus, with simplicity and control at heart, keep you focused on the subject, not on tech. Direct Group access, Lithium recycle speed and dependency, every primed for action, reaching across space with a flash so beautiful you'll wonder how we did it.

The R2 Family. Multiple distinct members from mini speedlights to monster monolights. Each one the results of insight and refinement. Becoming a frontrunner does not occur by coincidence. Only by expertise.

## Features

- Round zoom head design delivers the smoothest, most pleasing light ever to grace a speedlight
- Magnetic round flash head rim holds a treasury of light modifiers
- Beautiful Powerful Flash with GN 92ft / 28m @ISO 100 (50mm)
- Uses an advanced Li-Ion Polymer battery for speedy recycle and longer life
- Full power recycle time of fewer than 1.5 seconds
- Approximately 480 full power flashes per charge
- Remote Pentax TTL power control with the Flashpoint R2 System built-in
- Complete compatibility with TTL system features like exposure compensation, EXIF inscription, flash value lock, and High Speed Sync
- R2 TTL communication flashes as a Master or Slave
- Control of 4 different wireless groups
- Slave Mode operates on 5 Groups
- Backlit Matrix LCD
- Multipurpose Buttons with Digital Marking for Faster Navigation
- Zooming 28-105mm head with automatic or manual control
- High Speed Sync for shutter speeds up to 1/8000 second
- Front or Rear Curtain Sync
- Laser AF Assist Lamp for Instant Autofocus Even in Complete Dark on Low Contrast Surfaces
- 10 Level SMD LED Modeling Lamp
- Regular and Intelligent Optical Slave Modes
- Stable color temperature at  $5600\pm 200K$  over the entire power range
- 330-degree rotation and 120 degree tilt Head
- Perfect for on and off camera use
- Level Lock Hot Shoe Foot Clamp

## Conventions used in this Manual

- This manual is based on the assumption that both the camera and camera flash's power switches are powered on.
- Reference page numbers are indicated by "p.\*\*".
- The following alert symbols are used in this manual:

 The Caution symbol gives supplemental information.

 The Note symbol indicates a warning to prevent shooting.

# Contents

- 1 Foreword
- 2 Features
- 5 Name of Parts
  - Body
  - Control Panel
  - LCD Panel
- 8 Included Items
  - Separately Sold Accessories
- 9 Battery
- 10 LED Modeling Lamp
- 10 Attaching to a Camera
- 10 Power Management
- 11 Flash Mode — TTL Autoflash
  -  FEC (Flash Exposure Compensation)
  -  High-Speed Sync
  -  Second-Curtain Sync
- 13 M: Manual Flash
- 14 Multi: Stroboscopic Flash
- 15 Wireless Flash Shooting: R2 Radio (2.4GHz) Transmission
  - Positioning and Operation Range
  - Wireless Multiple Flash Shooting
  - Wireless Settings
  - Group Mode Selection
  - Setting the Communication Channel
  - Wireless ID Setting
  - Scan the Best Channel
  - TTL: Fully Automatic Wireless Flash Shooting
  - M: Wireless Flash Shooting with Manual Flash
- 22 Other Applications
  - Sync Triggering
  - Auto Focus Assist Beam
  - Bounce Flash
  - ZOOM: Setting the Flash Coverage
- 24 C.Fn: Setting Custom Functions
- 25 Protection Function
- 26 Technical Data
- 27 Troubleshooting
- 28 Firmware Upgrade
- 28 Compatible Camera Models
- 28 Maintenance
- 29 FCC Warning
- 30 Two Year Flashpoint Limited Warranty

# Name of Parts

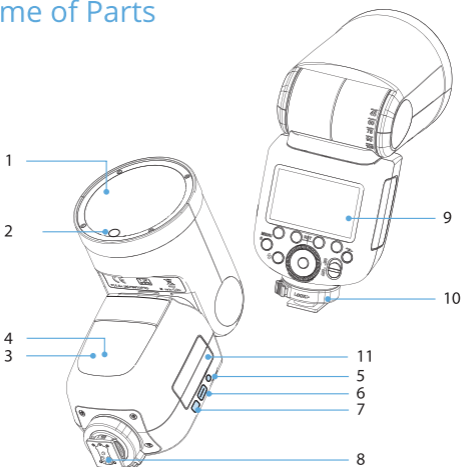

## Body

- |                             |                           |
|-----------------------------|---------------------------|
| 1. Flash Head               | 7. Battery Release Button |
| 2. LED Modeling Lamp(01~10) | 8. Hotshoe                |
| 3. Wireless Sensor          | 9. LCD Panel              |
| 4. Focus Assist Beam        | 10. Hotshoe Lock Lever    |
| 5. Sync Cord Jack           | 11. Lithium Battery       |
| 6. Type-C USB Port          |                           |

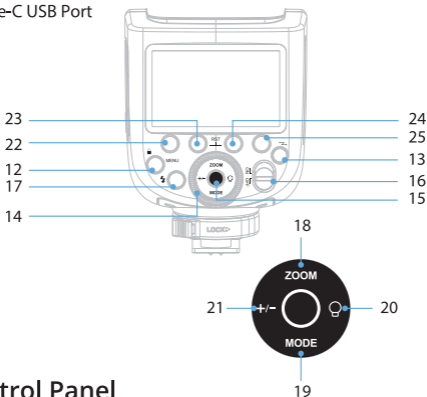

## Control Panel

- |   |                                  |
|---|----------------------------------|
| 12. <MENU> Flash Menu Button/Lock Button    | 19. <MODE> Mode Selection Button |
| 13. <Z> Wireless Selection Button           | 20. <Q> Modeling Lamp Setting    |
| 14. Select Dial                             | 21. <+/-> Power Output           |
| 15. Set Button                              | 22. Function Button 1            |
| 16. ON/OFF Power Switch                     | 23. Function Button 2            |
| 17. <F> Test Button / Flash Ready Indicator | 24. Function Button 3            |
| 18. <ZOOM> Lens Focal Length                | 25. Function Button 4            |

# LCD Panel

## (1) TTL Autoflash

**Zoom** : zoom display

**A** : Automatic

**M** : Manual

**TTL** : TTL autoflash

Lens focal length

**H** : High-speed sync

**▶** : Second curtain sync

**▶** : Master unit flash ON

**▶** : Master unit flash OFF

**1/2** : Flash exposure compensation

Flash exposure compensation amount

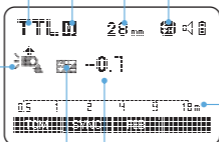

Distance indicator display

- The display will only show the settings currently applied.
- The functions displayed above function buttons 1 to 4, such as **SYNC** and **<A/B/C/D>**, change according to settings' parameters.
- When a button or dial is operated, the LCD panel illuminates.

## (2) M Manual Flash

**M** : Manual flash

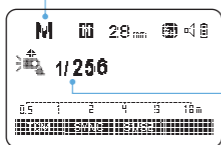

Manual flash output

## (3) Multi Flash

**Multi** : Stroboscopic flash

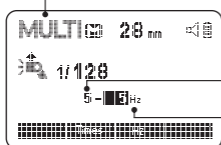

Number of flashes

Flash frequency

## (4) R2 Wireless Radio Photography

### ● Master Unit

Flash mode

 : R2 Radio transmission wireless shooting

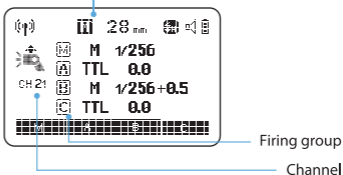

### ● Slave Unit

 : Slave icon

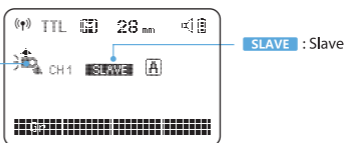

### ● LCD Panel in Three Modes Attached to the Camera

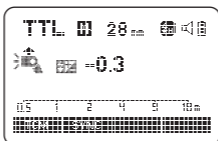

### R2 2.4GHz Radio transmission: As a Master Unit

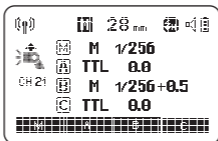

### R2 2.4GHz Radio transmission: As a Slave Unit

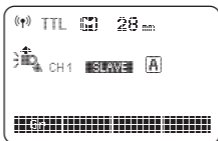



## Included Items

1. Flash Unit
2. Lithium Battery
3. USB Battery Charger
4. USB Cable
5. Charger
6. Mini Stand
7. Protection Case
8. Instruction Manual



1



2



3



4



5



6

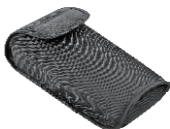

7

## Separately Sold Accessories

The product can be used in combination with the following accessories sold separately, so as to achieve best photography effects: Flashpoint R2 Pro Mark II & R2T II Wireless Transmitters, and Round Head Flash Accessory Kit.

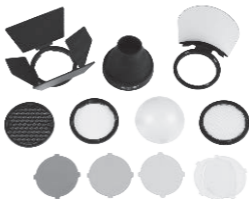

# Battery

## Features

1. The Zoom Li-on X flash unit uses a Lithium-Ion polymer battery with a long runtime. The approximated charge-and-discharge times are 500.
2. The battery is reliable and safe. Internal circuits protect against shorts and voltage irregularities.
3. The cells only require 3.5 hours to fully charge the battery using the standard battery charger.

## Cautions

1. Do not short circuit.
2. Do not expose to rain or immerse into water. This battery is not water proof.
3. Keep out of reach of children.
4. Avoid 24 hours of continuous charging.
5. Store in dry, cool, ventilated places.
6. Do not dispose in fire or incinerate.
7. Dead batteries should be disposed according to local regulations.
8. Never leave a depleted battery in storage. It is best to recharge batteries every 3 months.

## Loading and Unloading the Battery

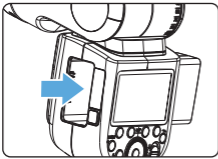

- 1 To unload the battery, hold down the Battery Release button and push the battery to the right. Slide the cell out of the channel.

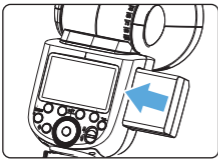

- 2 To load the battery, align printed side forward, making sure that the arrow and the contacts are facing left. Slide the cell into the compartment until the battery is firmly seated and locks with a 'click'.

## Battery Level Indication

Make sure the battery pack is securely loaded in the flash. Check the battery level indication on the LCD panel to see the remaining battery level.

| Battery Level Indication | Meaning  |
|--------------------------|--|
| 3 grids                  | Full battery   |
| 2 grids                  | Middle battery   |
| 1 grid                   | Low battery  |
| Blank grid               | Weak battery, please recharge.   |
| Blinking                 | The battery is depleted. The flash will auto power off in 1 minute.<br>Note: Please recharge the battery as soon as possible (within 10 days). |

## LED Modeling Lamp

Press the Modeling Lamp Setting button to set the modeling lamp. Short press the Set Button to turn on or off the modeling lamp. When turning the modeling lamp on, turn the select dial to set its brightness. The LED can be set to 10 levels of brightness, 1-10.

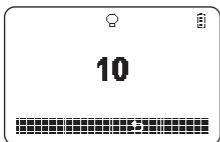

## Attaching to a Camera

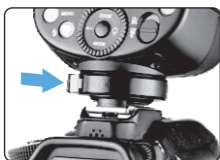

- 1 Attach the Camera Flash.**
  - Rotate the Hotshoe Lock Lever to the left and insert the camera flash into the camera's hotshoe.



- 2 Secure the Camera Flash.**
  - Rotate the Hotshoe Lock Lever to the right until it locks up.



- 3 Detach the Camera Flash.**
  - Press the button and rotate the Hotshoe Lock Lever to the left until it is loosened.

## Power Management

Use ON/OFF Power Switch to power the flash unit on or off. Turn off if it will not be used for an extended period of time. When set as a master flash, the flash unit will power off automatically after 90 seconds when not in use. Pressing the camera shutter halfway or pressing any flash button will wake up the flash unit. When set as a slave flash, it will enter sleep mode after 60 minutes of idle time. Press any flash button to wake it up.



**C.Fn** Disabling Auto Power Off function is recommended when the flash is used off camera. (C.Fn-STBY)

**C.Fn** Slave Auto Power Off Timer is set to 60 minutes by default. Another option "30 minutes" is available. (C.FnSv STBY)

## Flash Mode: TTL Autoflash

This flash has three flash modes: **TTL**, **Manual(M)**, and **Multi** (Stroboscopic). In **TTL** mode, the camera and the flash will work together to calculate the correct exposure for the subject and the background. In this mode, multiple TTL functions are available: FEC, HSS, second curtain sync, modeling flash, control with the camera's menu screen.

- \* Press **<MODE>** Mode Selection Button and three flash modes will display on the LCD panel one by one with each pressing.

### TTL Mode

- \* Press **<MODE>** Mode Selection Button to enter TTL mode. The LCD panel will display.
- Press the camera release button halfway to focus. The aperture and effective flash range will be displayed in the viewfinder.
- When the shutter button is fully pressed, the flash will fire a preflash that the camera will use to calculate exposure and flash output the instant before the photo is taken.

### FEC: Flash Exposure Compensation

With FEC function, this flash can adjust from -3 to +3 in 1/3rd stops. It is useful in situations where minor adjusting of the TTL system is needed based on the environment.

#### Setting FEC:

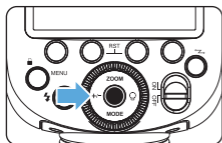

- 1 Press Function Button 2 Press the **<+/->** button. The icon **<FEC>** and flash exposure compensation amount will be highlighted on the LCD panel.

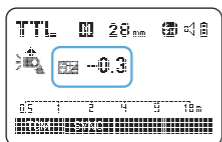

- 2 Set the flash exposure compensation amount.
  - Turn the Select Dial to set the amount.
  - "0.3" means 1/3 stop.
  - "0.7" means 2/3 stop.
  - To cancel the flash exposure compensation, set the amount to "+0".

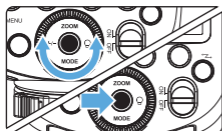



- 3 Press SET button again to confirm the setting.

## High-Speed Sync

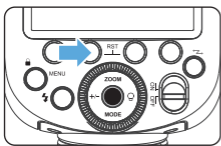
High Speed Sync (HSS) enables the flash to synchronize with all camera shutter speeds. This is convenient when you want to use aperture priority for fill-flash portraits.



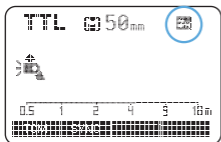

1 Press Function Button 2  so that  is displayed.



2 Check that  is displayed in the LCD Panel.



3 Set the camera shutter speed.

- If you set a shutter speed that is the same as or slower than the camera's maximum flash sync speed,  will not be displayed in the viewfinder.
- With high-speed sync, the faster the shutter speed, the shorter the effective flash range.
- To return to normal flash, press  button again. Then  will disappear.
- Multi flash mode cannot be set in high-speed sync mode.
- Over-temperature protection may be activated after 15 consecutive high-speed sync flashes.

## Second-Curtain Sync

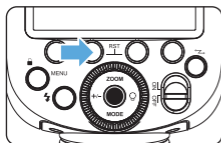
With a slow shutter speed, you can create a light trail following the subject. The flash fires right before the shutter closes.



Press function button 2  button so that  is displayed on the LCD panel.

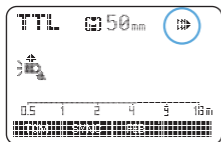

- Choose a slow shutter speed for the trail effect length and a correct aperture for the subject.
- Confirm Second Curtain Sync on the camera information panel.
- Remember to cancel SCS after the exposures.

## M: Manual Flash

The flash output is adjustable from 1/1 full power to 1/256th power in 1/10th stop increments. To obtain a correct flash exposure, use a hand-held flash meter to determine the required flash output.

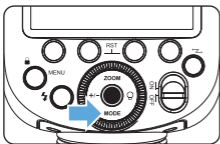

1 Press **<MODE>** button so that **<M>** is displayed.

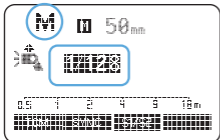

2 Press the +/- side of the Select Dial to activate the power setting mode that allows flash manual power output to be adjusted. The current power setting is highlighted.

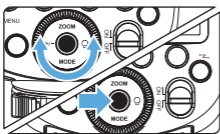

3 Turn the Select Dial to choose a desired flash output amount.

4 Press Set Button again to confirm the setting.

### Optic S1 Secondary Unit Setting

In M manual flash mode, press **<S1/S2>** button so that this flash can function as an optic S1 secondary flash with optic sensor. With this function, the flash will fire synchronously when the main flash fires, the same effect as that by the use of radio triggers. This helps create multiple lighting effects.

### Optic S2 Secondary Unit Setting

Press **<S1/S2>** button so that this flash can also function as an optic S2 secondary flash with optic sensor in M manual flash mode. This is useful when cameras have a pre-flash function. With this function, the flash will ignore a single "pre-flash" from the main flash and will only fire in response to the second, actual flash from the main unit.

- S1 and S2 optic triggering is only available in M manual flash mode.

## Multi: Stroboscopic Flash

With stroboscopic flash, a rapid series of flashes are fired. MULTI mode can be used to capture multiple images of a moving subject in a single photograph.

You can set the firing frequency (number of flashes per second, expressed as Hz), the number of flashes, and the flash output.

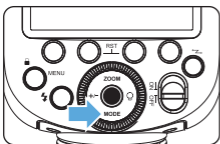

1 Press <MODE> button so that <MULTI> is displayed.

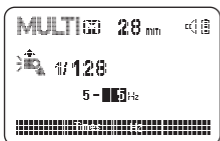

2 Set the flash frequency and flash times.

- Press the Function Button 2 <Times> to select the flash times. Turn the Select Dial to set the number.
- Press the Function Button 3 <Hz> to select the flash frequency. Turn the Select Dial to set the number.

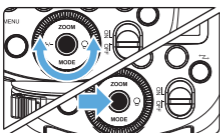

3 Turn the Select Dial to choose a desired flash output.

- After you finish the setting, press Set Button and all the settings will be displayed.

### Calculating the Shutter Speed

During stroboscopic flash, the shutter must remain on until the firing stops. Use the formula below to calculate the shutter speed and set it with the camera.

### Number of Flashes / Flash Frequency = Shutter Speed

For example, if the number of flashes is 10 and the firing frequency is 5 Hz, the shutter speed should be at least 2 seconds.

**⚠** To avoid overheating and deteriorating the flash head, do not use stroboscopic flash more than 10 times in succession. After 10 times, allow the camera flash to rest for at least 15 minutes. If you try to use the stroboscopic flash more than 10 times in succession, the firing might stop automatically to protect the flash head. If this happens, allow at least 15 minutes' rest for the camera flash.

- Stroboscopic flash is most effective with a highly reflective subject against a dark background.
- Using a tripod and a remote control is recommended.
- A flash output of 1/1 and 1/2 cannot be set for stroboscopic flash.
- Stroboscopic flash can be used with "bulb".
- If the number of flashes is displayed as "--", the firing will continue until the shutter closes or the battery is exhausted. The number of flashes will be limited as shown by the following table.

## Maximum Stroboscopic Flashes:

| Flash output \ Hz | 1  | 2  | 3  | 4  | 5  | 6-7 | 8-9 |
|-------------------|----|----|----|----|----|-----|-----|
| 1/4               | 8  | 6  | 4  | 3  | 3  | 2   | 2   |
| 1/8               | 14 | 14 | 12 | 10 | 8  | 6   | 5   |
| 1/16              | 30 | 30 | 30 | 20 | 20 | 20  | 10  |
| 1/32              | 60 | 60 | 60 | 50 | 50 | 40  | 30  |
| 1/64              | 90 | 90 | 90 | 80 | 80 | 70  | 60  |
| 1/128             | 90 | 90 | 90 | 90 | 90 | 90  | 80  |
| 1/256             | 90 | 90 | 90 | 90 | 90 | 90  | 80  |

| Flash output \ Hz | 10 | 20-50 | 60-100 |
|-------------------|----|-------|--------|
| 1/4               | 2  | 2     | 2      |
| 1/8               | 4  | 4     | 4      |
| 1/16              | 8  | 8     | 8      |
| 1/32              | 20 | 16    | 12     |
| 1/64              | 50 | 30    | 20     |
| 1/128             | 70 | 40    | 40     |
| 1/256             | 70 | 40    | 40     |

## Wireless Flash Shooting: R2 Radio (2.4GHz) Transmission

- The Zoom Li-on X attached to the camera is called the Master unit, and a Zoom Li-on X that is wirelessly controlled is called the Slave unit.
- You can also wirelessly control the Zoom Li-on X set as the slave unit with the transmitter R2T-S or R2T Pro S (sold separately). For details on setting the master unit functions, see the transmitter's instructions.

Using a flash (master/slave) with a radio transmission wireless shooting function make it easy to shoot with advanced wireless multiple flash lighting, in the same way as TTL autoflash shooting.

The basic relative position and operation range are as shown in the picture. You can then perform wireless TTL autoflash shooting just by setting the master unit to <TTL>.



## Positioning and Operation Range

(Example of wireless flash shooting)

- Autoflash Shooting with One Slave Unit

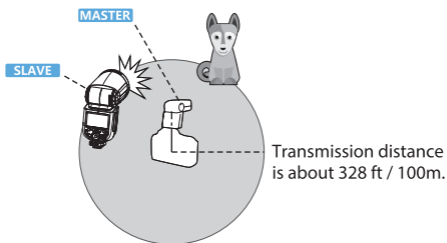

- Use the supplied mini stand to position the slave unit.
- Before shooting, perform a test flash and test shooting.
- The transmission distance might be shorter depending on the conditions such as positioning of slave units, the surrounding environment and weather conditions.

## Wireless Multiple Flash Shooting

You can divide the slave units into two or three groups and perform TTL autoflash while changing the flash ratio (factor). In addition, you can set and shoot with a different flash mode for each firing group, for up to 4 groups.

- Auto Shooting with Two Slave Groups

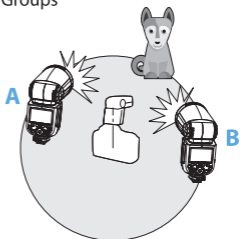

- Auto Shooting with Three Slave Groups

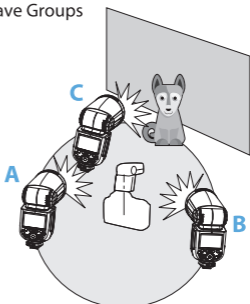

## 1. Wireless Settings

You can switch between normal flash and wireless flash. For normal flash shooting, be sure to set the wireless setting to OFF.

### Master Unit Setting

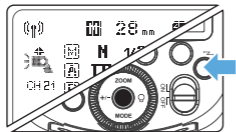

Press **<w>** button so that **<w>** is displayed on the LCD panel.

### Slave Unit Setting

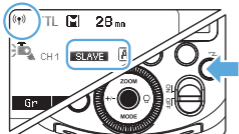

Press **<w>** button so that **<w>** or **<SLAVE>** are displayed on the LCD panel.

## 2. Group Mode Selection

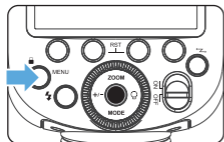

**1** The function button 1/2/3/4 can control the Group. Short press function button to select TTL/M/OFF. Choose one of them as the flash mode of the master unit.

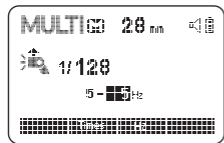

**2** Press **<MODE>** button to switch to Multi mode.

## 3. Setting the Communication Channel

If there are other wireless flash systems nearby, you can change the channel IDs to prevent signal interference. The channel IDs of the master unit and the slave unit(s) must be set to the same value.

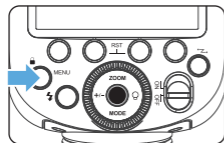

**1** Press **<MENU>** Button to enter C.Fn CH setting.

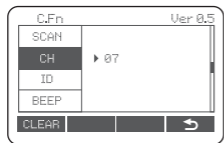

**2** In C.Fn CH, turn the Select Dial to choose channel ID from 1 to 32.

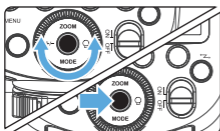

**3** Press the Set Button to confirm.

## 4. Wireless ID Setting

Change the wireless channel and wireless ID to avoid interference and to gain added wireless security. The wireless IDs and Channel of the Master and Slave units must be set to the same value. Press the **<MENU>** button to enter C.Fn ID. Press the SET button to highlight the OFF setting. Rotate the Select Dial to choose any value from 1 to 99. Press the SET button to fix the ID value.

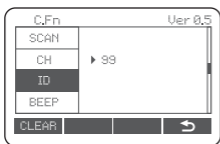

## 5. Scan the Best Channel

This feature scan the channel option for the strongest values: enter the C.Fn settings and find the SCAN option. When setting it to START, it will scan from 1% to 100%. And the 8 best channels will be displayed after the scan is completed.

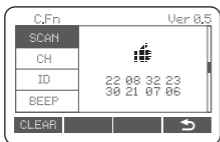

## 6. TTL: Fully Automatic Wireless Flash Shooting Using Automatic Wireless Flash with a Single Slave Unit

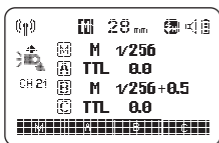

### 1 Master Unit Setting

- Attach a Zoom Li-on X flash on the camera and set it as the master unit.
- M/A/B/C can be set to TTL separately.

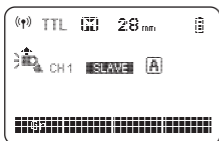

### 2 Slave Unit Setting

- Set the other camera flash as the wireless slave Unit.

### 3 Check the communication channel.

- If the master unit and slave unit(s) are set to a different channel, set them to the same channel.

### 4 Position the camera and flashes.

- Position the camera and flashes as the picture shows.

### 5 Check that the flash is ready.

- Check that the master flash ready indicator is lightened.

### 6 Check the flash operation.

- Press the master unit's Test Button <⚡>.
- Then, the slave unit will fire. If not, adjust the slave unit's angle toward the master unit and distance from the master unit.

## Using Automatic Wireless Flash with Multiple Slave Units

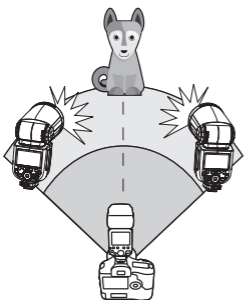

When stronger flash output or more convenient lighting operation is needed, increase the number of slave units and set it as a single slave unit.

To add slave units, use the same steps as setting "automatic wireless flash with a single slave unit". Any flash group can be set (A/B/C/D/E).

When the number of slave units is increased and the master unit flash firing is ON, automatic control sends the R2 radio signal to all the groups of flashes to fire the same flash output and provide perfect exposure.

- If the slave unit's auto power off function is workable, press the master unit's test button to power it on. Please note that test firing is unavailable during the camera's regular metering operation.
- The effective time of slave auto power off is changeable. (C.Fn-Sv STBY)

## Using Fully Automatic Wireless Flash

The FEC and other settings that set on the master unit will also be appeared on the slave unit automatically. The slave unit does not need any operation. Use the following settings to make wireless flashes according to the same methods with normal flash shooting.

- Flash Exposure Compensation <  >

## About Master Unit

Use two or more master units. By preparing several cameras that with master units flash attached, cameras can be changed in shooting while keeping the same lighting source (slave unit).

## 7. M: Wireless Flash Shooting with Manual Flash

This describes wireless multiple flash lighting using manual flash. You can shoot with a different flash output setting for each slave unit firing group. Set all parameters on the master unit.

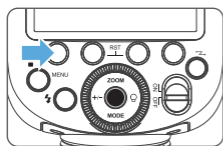

**1** Setting the flash mode to <M>.

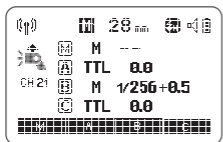

**2** Setting flash output.  
1/2/3/4<M/A/B/C>

- Press Function Button 3 <Gr>. Turn the Select Dial to set the flash output of the groups. Press Set Button to confirm.

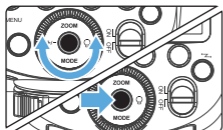

**3** Taking the picture.

- Each group fires at the set flash ratio.

### Setting <M> Flash Mode

You can directly operate the slave unit to manually set the manual flash or stroboscopic flash.



**1** Setting the slave unit.

**2** Setting flash mode to <M>.

- Press <MODE> button so that <M> is displayed.
- Set the manual flash output.

## 8. Multi: Wireless Flash Shooting with Manual Flash



**Setting <MULTI> stroboscopic flash.**

- Press <MODE> button so that <MULTI> is displayed.
- Set the stroboscopic flash.

## Other Applications

### Sync Triggering

The Sync Cord Jack is a  $\Phi 2.5\text{mm}$  plug. Insert a trigger plug here and the flash will be fired synchronously with the camera shutter.

### Auto Focus Assist Beam

In poorly-lit or low-contrast shooting environments, the built-in auto focus assist beam will automatically light on to make it easier for autofocus. The beam will light only when autofocus is difficult and turn off as soon as the autofocus is achieved.

If you want to turn off the auto focus assist beam, set the "AF" to "OFF" on the C.Fn settings.



- If you find the auto focus assist beam does not light up, this is because the camera has correct autofocus.

| Position  | Effective Range         |
|-----------|-------------------------|
| Center    | 0.6~10m / 2.0~32.8 feet |
| Periphery | 0.6~5m / 2.0~16.4 feet  |

## Bounce Flash

By pointing the flash head toward a wall or ceiling, the flash will bounce off the surface before illuminating the subject. This can soften shadows behind the subject for a more natural-looking shot. This is called bounce flash.

**To set the bounce direction, hold the flash head and turn it to a satisfying angle.**

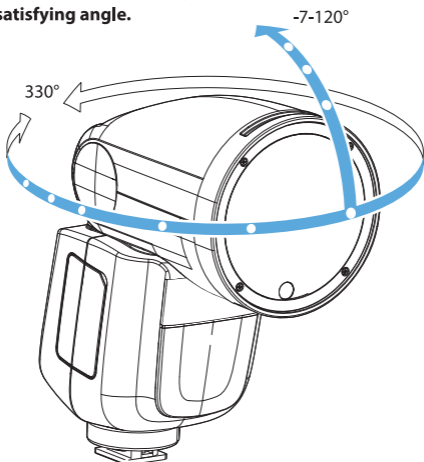

- If the wall or ceiling is too far away, the bounced flash might be too weak and result in underexposure.
- The wall or ceiling should be a plain, white color for high reflectance. If the bounce surface is not white, a color cast may appear in the picture.

## ZOOM: Setting the Flash Coverage

The flash coverage can be set automatically or manually. It can be set to match the lens focal length from 28mm to 105mm.

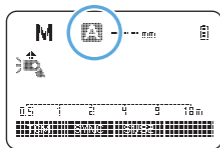

**In Manual Zoom mode, press the <ZOOM> button.**

- Turn the Select Dial to change the flash coverage.
- If <A> is displayed, the flash coverage will be set automatically.

- If you set the flash coverage manually, make sure it covers the lens focal length so that the picture will not have a dark periphery.

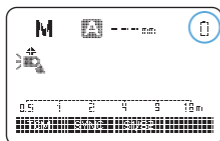

## Low Battery Warning

If the battery power is low, <🔋> appear and blink on the LCD panel. Please replace the battery immediately.



## C.Fn: Setting Custom Functions

The following table lists the available and unavailable custom functions of this flash.

| C.Fn Custom Functions |                            |            |                                 |
|-----------------------|----------------------------|------------|---------------------------------|
| Custom Function Signs | Function                   | Setting No | Settings & Description          |
| m/ft                  | Distance indicator         | m          | m                               |
|                       |                            | ft         | feet                            |
| AF                    | AF-assist beam             | ON         | ON                              |
|                       |                            | OFF        | OFF                             |
| STBY                  | Auto sleep setting         | ON         | ON                              |
|                       |                            | OFF        | OFF                             |
| Sv STBY               | Slave auto power off timer | 60min      | 60min                           |
|                       |                            | 30min      | 30min                           |
| SCAN                  | Scan the spare channel     | OFF        | OFF                             |
|                       |                            | START      | Start to find the spare channel |
| CH                    | Channel setting            | 01-32      | Choose channels from 01-32      |
| ID                    | Wireless ID                | OFF        | OFF                             |
|                       |                            | 01-99      | Choose any figure from 01-99    |
| BEEP                  | Audio Tone                 | ON         | ON                              |
|                       |                            | OFF        | OFF                             |
| LIGHT                 | Backlighting time          | 12sec      | Off in 12 sec.                  |
|                       |                            | OFF        | Always off                      |
|                       |                            | ON         | Always lighting                 |
| LCD                   | LCD contrast ratio         | -3~+3      | 7 levels                        |
| FEB ACL               | FEB auto cancel            | ON         | ON                              |
|                       |                            | OFF        | OFF                             |
| MASTER                | Master unit control        | OFF        | OFF                             |
|                       |                            | ON         | ON                              |

1. Press **<MENU>** Button until C.Fn menu is displayed. The "Ver x.x" in the top-right corner refers to the software version.
2. Select the Custom Function No.
  - Turn the Select Dial to select the Custom Function No.
3. Change the Setting.
  - Press Set Button and the Setting No. blinks.
  - Turn the Select Dial to set the desired number. Pressing Set Button will confirm the settings.
  - After you set the Custom Function and press **<MENU>** button, the camera will be ready to shoot.
4. In the C.Fn states, long press the "Clear" button for 2 seconds until "OK" is displayed on the panel, which means the values in C.Fn can be reset.

# Protection Function

## 1. Over-Temperature Protection

- To avoid overheating and deteriorating the flash head, do not fire more than 30 continuous flashes in fast succession at 1/1 full power. After 30 continuous flashes, allow a rest time of at least 10 minutes.
- If you fire more than 30 continuous flashes and then fire more flashes in short intervals, the inner over-temperature protection function may be activated and make the recycling time over 10 seconds. If this occurs, allow a rest time of about 10 minutes, and the flash unit will then return to normal.
- When the over-temperature protection is started,  is shown on the LCD display.

Number of flashes that will activate over-temperature protection:

| Power Output Level  | Number of Flashes |
|---------------------|-------------------|
| 1/1                 | 30                |
| 1/2 +0.7            | 40                |
| 1/2 +0.3            | 50                |
| 1/2                 | 60                |
| 1/4 ( +0.3,+0.7 )   | 100               |
| 1/8 ( +0.3,+0.7 )   | 200               |
| 1/16 ( +0.3,+0.7 )  | 300               |
| 1/32 ( +0.3,+0.7 )  | 500               |
| 1/64 ( +0.3,+0.7 )  | 1000              |
| 1/128 ( +0.3,+0.7 ) |                   |

Number of flashes that will activate over-temperature protection in high-speed sync triggering mode:

| Power Output      | Times |
|-------------------|-------|
| 1/1               | 15    |
| 1/2(+0.3,+0.7);   | 20    |
| 1/4(+0.3,+0.7)    | 30    |
| 1/8(+0.3,+0.7);   |       |
| 1/16(+0.3,+0.7)   | 40    |
| 1/32(+0.3,+0.7);  |       |
| 1/64(+0.3,+0.7);  | 50    |
| 1/128(+0.3,+0.7); |       |

## 2. Other Protections

The system provides real-time protection to secure the device and your safety. The following lists prompts for your reference:

| Prompts on LCD Panel | Meaning  |
|----------------------|--|
| E1                   | Issue detected with the recycling system so that the flash cannot fire.<br>Please restart the flash unit. If the problem still exists, please send this product to a maintenance center. |
| E2                   | The system is too hot. Please allow a rest time of 10 minutes.   |
| E3                   | The voltage on the flash tube is too high.<br>Please send this product to a maintenance center.  |
| E9                   | Some errors occurred during the upgrading process.<br>Please using the correct firmware upgrade method.  |





# Technical Data

| Model                                    | Flashpoint Zoom Li-on X for Pentax  |
|--|---|
| Compatible Cameras                       | Pentax cameras  |
| Power (1/1 output)                       | 76Ws  |
| Flash Coverage                           | 28 to 105mm<br><ul style="list-style-type: none"> <li>• Auto zoom (Flash coverage set automatically to match the lens focal length and image size)</li> <li>• Manual zoom</li> <li>• Swinging/tilting flash head (bounce flash): 0 to 330° horizontally and -7° to 120° vertically</li> </ul> |
| Flash Duration                           | 1/300 to 1/20000 seconds  |
| <b>• Exposure Control</b>                |   |
| Exposure control system                  | TTL autoflash and manual flash  |
| Flash exposure compensation (FEC)        | Manual. FEB: ±3 stops in 1/3 stop increments (Manual FEC and FEB can be combined.)  |
| FE lock                                  | With <FEL> button or <* > button  |
| Sync mode                                | High-speed sync (up to 1/8000 seconds), first-curtain sync, and second-curtain sync   |
| Multi flash                              | Provided (up to 100 times, 199Hz)   |
| <b>• Wireless Flash</b>                  |   |
| Wireless flash function                  | Master, Slave, Off  |
| Master groups                            | M/A, B, C, D  |
| Controllable slave groups                | A, B, C, D, E (E group can be controlled by R2 series flash trigger)  |
| Transmission range (approx.)             | 328ft / 100m  |
| Channels                                 | 32 (1~32)   |
| ID                                       | 01~99   |
| Modeling flash                           | Fired with camera's depth-of-field preview button   |
| <b>• Auto Focus Assist Beam</b>          |   |
| Effective range (approx.)                | Center: 0.6~10m / 2.0~32.8 feet<br>Periphery: 0.6~5m / 2.0~16.4 feet  |
| <b>• LED Modeling Lamp</b>               |   |
| Power                                    | 2W  |
| Color Temperature                        | 3300K±200K  |
| <b>• Power Supply</b>                    |   |
| Power source                             | 7.2V/2600mAh Lithium-Ion battery  |
| Recycle time                             | Approx 1.5 seconds. Green LED indicator will light up when the flash is ready.  |
| Full power flashes                       | Approx. 480   |
| Power saving                             | Power off automatically after approx. 90 seconds of idle operation. (60 minutes if set as slave)  |
| <b>• Sync Triggering Mode</b>            | Hotshoe, 2.5mm sync port  |
| <b>• Color Temperature</b>               | 5600±200k   |
| <b>• Dimensions</b>                      |   |
| W × H × D                                | 3.0 × 3.6 × 7.75" / 76 × 93 × 197mm   |
| Weight without battery                   | 14.8oz / 420g   |
| Weight with battery                      | 18.8oz / 534g   |
| 2.4G Wireless Frequency Range            | 2413.0MHz-2464.5MHz   |
| Max. Transmitting Power of 2.4G Wireless | 5dbm  |

## Troubleshooting

If there is a problem, refer to this Troubleshooting Guide.

### The Camera Flash does not fire.

- The camera flash is not attached securely to the camera.  
→ Attach the camera's mounting foot securely to the camera.
- The electrical contacts of the Camera Flash and camera are dirty.  
→ Clean the contacts.
-  or  is not displayed in the view finder of camera.  
→ Wait until the flash is fully recycled and the flash ready indicator lights up.  
→ If the flash ready indicator lights up, but  or  is not displayed in the view finder, check whether this flash unit is securely attached to the camera hotshoe.  
→ If the flash ready indicator does not light up after a long wait, check whether the battery power is enough. If the battery power is low,  will appear and blink on the LCD panel. Please replace the battery immediately.

### The power turns off by itself.

- After 90 seconds of idle operation, auto power off took effect if the flash is set as master.  
→ Press the shutter button halfway or press any flash button to wake up.
- After 60 minutes (or 30 minutes) of idle operation, the flash unit will enter sleep mode if it is set as slave.  
→ Press any flash button to wake up.

### Auto zoom does not work.

- The camera flash is not attached securely to the camera.  
→ Attach the camera flash's mounting foot to the camera.

### The flash exposure is underexposed or overexposed.

- There was a highly reflective object (e.g. glass window) in the picture.  
→ Use FE lock (**FEL**).
- You used High Speed Sync.  
→ With high-speed sync, the effective flash range will be shorter. Make sure the subject is within the effective flash range displayed.
- You used Manual Flash mode.  
→ Set the flash mode to **TTL** or modify the flash output.

### Photos have dark corners or only parts of the target subject are illuminated.

- The focal length of lens exceeds the flash coverage.  
→ Check the flash coverage you set. This flash unit has the flash coverage between 28 and 105mm, which fits medium-format cameras.

## Firmware Upgrade

- The USB port is a Type-C USB socket. Connect to a computer using a data Type C USB cable.
- As the firmware upgrade needs the support of Flashpoint F3 software, please download and install the "Flashpoint F3 firmware upgrade software" before upgrading. Then, choose the related firmware file.
- Keep the Zoom Li-on X firmware up to date. Check the Flashpoint Firmware Download Center for the latest versions.

## Compatible Camera Models

This flash unit can be used on the following **Pentax series camera models**:

645Z

K-311

K-1

KP

K-50

K-52

K-70

- This table only lists the tested camera models, not all series cameras. For the compatibility of other camera models, a self-test is recommended.

Rights to modify this table are retained.

## Maintenance

- Shut down the device immediately should abnormal operation be detected.
- Avoid sudden impacts and the product should be dedusted regularly.
- It is normal for the flash tube to be warm when in use. Avoid continuous flashes if unnecessary.
- Maintenance of the flash must be performed by our authorized maintenance department which can provide original accessories.
- This product, except consumables e.g. flash tube, is supported with a one-year warranty.
- Unauthorized service will void the warranty.
- If the product had failures or was exposed to moisture, do not use it until it is repaired by professionals.
- Changes made to the specifications or designs may not be reflected in this manual.

## FCC Warning

This device complies with part 15 of the FCC Rules. Operation is subject to the following two conditions: (1) This device may not cause harmful interference, and (2) this device must accept any interference received, including interference that may cause undesired operation.

Any Changes or modifications not expressly approved by the party responsible for compliance could void the user's authority to operate the equipment.

**Note:** This equipment has been tested and found to comply with the limits for a Class B digital device, pursuant to part 15 of the FCC Rules. These limits are designed to provide reasonable protection against harmful interference in a residential installation. This equipment generates uses and can radiate radio frequency energy and, if not installed and used in accordance with the instructions, may cause harmful interference to radio communications. However, there is no guarantee that interference will not occur in a particular installation. If this equipment does cause harmful interference to radio or television reception, which can be determined by turning the equipment off and on, the user is encouraged to try to correct the interference by one or more of the following measures:

- ▶ Reorient or relocate the receiving antenna.
- ▶ Increase the separation between the equipment and receiver.
- ▶ Connect the equipment into an outlet on a circuit different from that to which the receiver is connected.
- ▶ Consult the dealer or an experienced radio/TV technician for help.

### **\*RF warning:**

This equipment complies with FCC radiation exposure limits set forth for an uncontrolled environment. This equipment should be installed and operated with minimum distance 8 inches / 20 cm between the radiator & your body.

## Two Year Flashpoint Limited Warranty

Flashpoint warrants to the original purchaser that your Flashpoint Zoom Li-on X be free from defects in material and workmanship for the period of two (2) year from the date of purchase (or delivery as may be required in certain jurisdictions), or thirty (30) days after replacement, whichever comes later.

Flashpoint's entire liability and your exclusive remedy for any breach of warranty shall be, at Flashpoint's option, to repair or replace the hardware, provided that the hardware is returned to the point of purchase or such other place as Flashpoint may direct with a copy of the sales receipt or dated itemized receipt. Flashpoint may, at its option, replace your product, offer to provide a functionally equivalent product, or repair any product with new, refurbished or used parts as long as such parts are in compliance with the product's technical specifications. Any replacement hardware product will be warranted for the remainder of the original warranty period or thirty (30) days, whichever is longer, or for any additional period of time that may be applicable in your jurisdiction. If the product has been discontinued, the warranty provider reserves the right to replace it with a model of equivalent quality and function.

This warranty does not cover problems or damage resulting from accident, abuse, misapplication, or any unauthorized repair, modification or disassembly, improper operation or maintenance, normal wear and tear, or usage not in accordance with product instructions or connection to improper voltage supply, use of consumables, such as replacement batteries, not supplied by Flashpoint, except where such restriction is prohibited by applicable law.

Except where prohibited by applicable law, this warranty is nontransferable and is limited to the original purchaser and the country in which the product was purchased. This warranty gives you specific legal rights, and you may also have other rights, including a longer warranty duration that may vary under local laws.

To start a warranty claim contact the Flashpoint Customer Service Department to obtain a return merchandise authorization ("RMA") number, and return the defective product to Flashpoint, along with the RMA number and proof of purchase.

### Question about our product line? Need Product Support?

We are proud of our products and celebrate our customers.

We are with you, from product selection to everyday use.

Be secure with your purchase and reach us as you need.

**Email us:** brands@adorama.com      **Call:** 212-647-9300

**Address:** Adorama Brands, 42 West 18th Street, New York, NY 10011

**You can always contact us at BRANDS@ADORAMA.COM for personal technical support. Our website contains a wide range of Support and FAQ pages with valuable technical assistance.**

Flashpoint is a registered trademark of ADORAMA CAMERA.

© 2019 Adorama Camera, Corp. All Rights Reserved.