



**1080P**  
PROGRESSIVE



# **16x16 DVI Matrix w/ Push Button Control**

**GEF-DVI-16416-PB**

**User Manual**

**[www.gefenpro.com](http://www.gefenpro.com)**



## ASKING FOR ASSISTANCE

---

### Technical Support:

Telephone (818) 772-9100  
(800) 545-6900

Fax (818) 772-9120

### Technical Support Hours:

8:00 AM - 5:00 PM Monday - Friday, Pacific Time

For 24 / 7 support, see the front panel of the product for the support number

### Write To:

Gefen, LLC  
c/o Customer Service  
20600 Nordhoff St  
Chatsworth, CA 91311

[www.gefenpro.com](http://www.gefenpro.com)  
[support@gefenpro.com](mailto:support@gefenpro.com)

### Notice

Gefen, LLC reserves the right to make changes in the hardware, packaging, and any accompanying documentation without prior written notice.

**16x16 DVI Matrix w/ Push Button Control**  
is a trademark of Gefen LLC

© 2011 Gefen, LLC. All rights reserved.  
All trademarks are the property of their respective owners.

**Rev A6**

# CONTENTS

---

1	Introduction
2	Operation Notes
3	Features
4	Front Panel Layout
5	Front Panel Descriptions
6	Back Panel Layout
7	Back Panel Descriptions
8	Connecting And Operating The 16x16 DVI Matrix
8	Wiring Diagram
9	Front Panel Display
10	Mode Buttons
10	Routing
11	Status Check
11	Standby
12	EDID
14	Saving Presets
15	Loading Presets
16	Masking
17	IR Remote Description
18	IR Remote Installation
19	IR Code Configuration
20	RS-232 Serial Control Interface
21	EDID Management
26	IP / Telnet Configuration
34	Routing
36	Masking
38	Miscellaneous
43	Web Interface
43	Configuring the IP Address
44	View Matrix Status
48	Manage EDID
54	Masking
55	IP Configuration
56	Backup / Restore
57	Power Management
59	Firmware Update
61	Rack Mount Safety Information
62	Specifications
63	Warranty
64	Licensing

# INTRODUCTION

---

Congratulations on your purchase of the GefenPRO 16x16 DVI Matrix with Front Panel Push Button Control. Your complete satisfaction is very important to us.

## **GefenPRO**

In the realm of video distribution, certain features are invaluable in a commercial or broadcast environment. Accommodations such as a build-in power supply and flat black rack-mount enclosures set GefenPRO apart from our traditional products. Complex distribution units allow for professional DVI, 3G-SDI, and HDMI signals to be routed and converted easily and seamlessly, while being backed up by a renowned and dependable technical support team. Gefen invites you to explore the GefenPRO product line and hopes that you find the solution that fits your needs.

## **The GefenPRO 16x16 DVI Matrix with Front Panel Push Button Control**

Simplify the process of routing up to 16 DVI sources to any of 16 DVI monitors without losing quality or resolution. This Matrix provides a simple, reliable, and highly effective method of streamlining any installation using multiple sources and outputs, taking the hassle out of managing multiple connections. Each DVI source is accessible at all times by any monitor using the front-panel buttons, IR remote unit, built-in RS-232 or using IP control.

## **How It Works**

Connect 16 sources to the DVI input ports on the Matrix using the supplied DVI cables. Connect 16 monitors to the Matrix. Power on the source devices and the monitors. Plug in the power cord and power on the Matrix. Use the push buttons on the front panel for routing each DVI source to the desired display. The connected monitors will display video according to the routing state.

**NOTE:** This Matrix only supports DVI-D. The DVI connectors on the Matrix all have 29 pins.

## OPERATION NOTES

---

### READ THESE NOTES BEFORE INSTALLING OR OPERATING THE GEFENPRO 16X16 DVI MATRIX WITH FRONT PANEL PUSH BUTTON CONTROL

- The 16x16 DVI Matrix does not support HDCP content.
- Make sure that a DVI monitor is powered and connected to one of the DVI outputs on the 16x16 DVI Matrix before applying power. By default, the Local EDID is read from the connected monitor and is copied to all 16 DVI inputs once the Matrix has been turned on. If a monitor is not detected by the Matrix at power-on, a default (internal) EDID of 640x480 will be used. This functionality can be disabled using the Secure Local EDID function using RS-232 or IP control.
- There is no internal scaling in the 16x16 DVI Matrix. Each monitor attached to the Matrix must be able to display the resolutions output by the source device(s). For maximum compatibility it is recommended that only one common resolution be used by each source device.
- Advanced EDID features and IP configuration features are accessible through the RS-232 serial command set.
- Routing and EDID features can be managed using the built-in IP control feature.
- This matrix supports Dynamic EDID. See pages 21 and 45 for details.
- **IMPORTANT:** If the unit is installed in a closed or multi-rack assembly, do not block the ventilation holes of the enclosure.

# FEATURES

---

## Features

- Supports resolutions up to 1920 x 1200
- Front panel control buttons for local switching
- Status LCD (shows routing status)
- Advanced EDID management provides rapid integration of sources and displays
- Dynamic EDID support
- Serial RS-232 interface for remote control via a computer or control automation devices
- IP Control
- Output masking command
- IR Remote Control
- IR Extender
- Power On/Off switch
- Internal power supply
- Grounding Terminal
- Standby mode
- Supports DDWG standards for DVI
- Rack-mountable

## Package Includes

- (1) GefenPRO 16x16 DVI Matrix with Front Panel Push Button Control
- (16) 6 ft. DVI cables (M-M)
- (1) IR Remote Control Unit
- (1) AC Power Cord
- (1) User Manual

# PANEL LAYOUT

## Front Panel

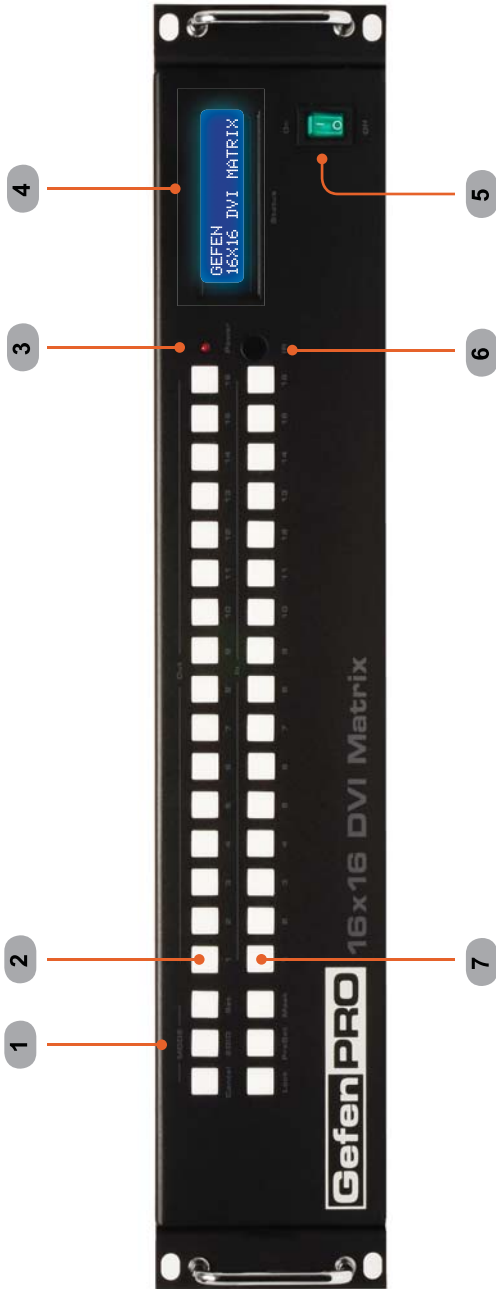

# PANEL DESCRIPTIONS

---

## Front Panel

**1 Mode Buttons**

These buttons are used to control other features on the product. See pages 11 - 17 for more information.

**2 Output Buttons (1 - 16)**

Used for routing an Input to an Output. Each of these buttons represents an Output. See page 10 for more information on routing DVI sources.

**3 Power Indicator**

This LED indicator will glow red when the power is turned on.

**4 LCD Display**

Displays the current routing status of the Matrix and is also used to manage source routing.

**5 Power**

Receives signals from the IR Remote Control unit.

**6 IR Window**

Receives signals from the IR Remote Control unit.

**6 Input Buttons (1 - 16)**

Used for routing an Input to an Output. Each of these buttons represents an Input. See page 10 for more information on routing DVI sources.

# PANEL LAYOUT

## Back Panel

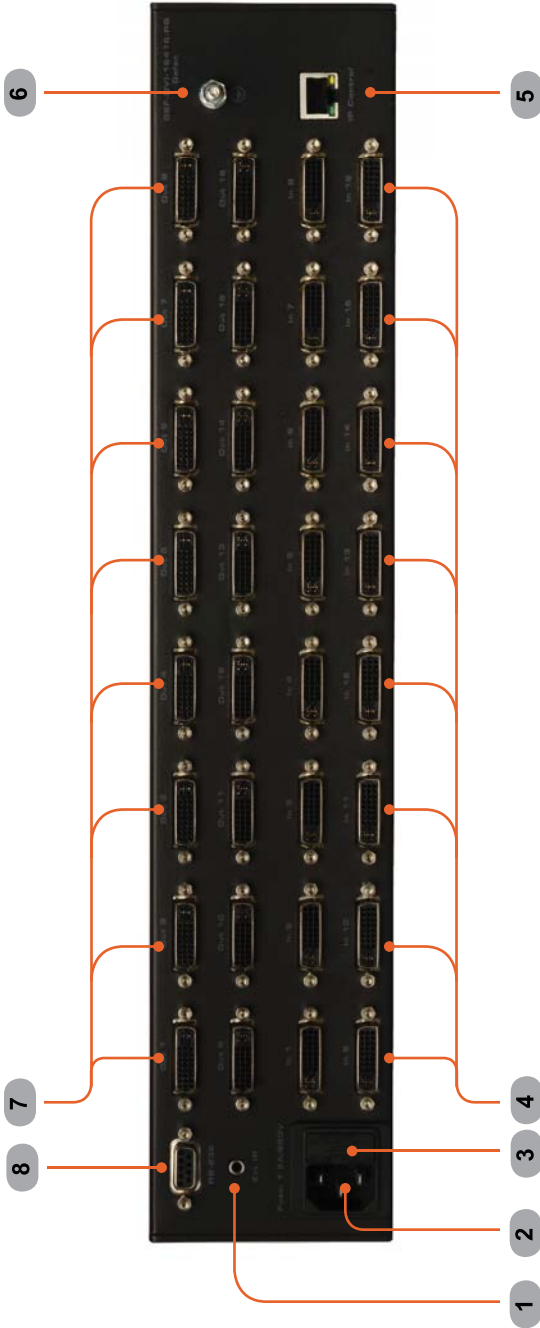

# PANEL DESCRIPTIONS

---

## Back Panel

**1 IR Extender Port**

Connect an IR extender cable to this port.

**2 AC 110 / 220 V AC (50/60 Hz) Power Cable Receptacle**

Connect the included AC power cord from this receptacle to an available electrical outlet.

**3 Fuse Drawer**

Each power receptacle houses a fuse drawer. Within each fuse drawer are two (2) 250 V fuses. One fuse is active and the other is a spare.

**4 DVI Input Ports (1 - 16)**

Connect DVI source devices to these ports.

**5 IP Control Interface**

Connect to this port to control the 16x16 DVI Matrix using IP Control. See page 43 for more information.

**6 Grounding Terminal**

Provides a discharge path to ground in case a short circuit occurs between the "hot" lead of the power supply and the enclosure of the Matrix. The grounding wire should be attached from the grounding terminal to an approved ground path.

**7 DVI Output Ports (1 - 16)**

Connect DVI monitors to these ports.

**8 RS-232 Serial Port**

Connects to the RS-232 control device. The 16x16 DVI Matrix may be switched remotely using this port. See page 20 for more information.

# CONNECTING AND OPERATING THE 16X16 DVI MATRIX

## How to Connect the 16x16 DVI Matrix

1. Connect up to 16 DVI source devices to the DVI inputs on the rear panel of the 16x16 DVI Matrix using the supplied DVI cables.
2. Connect up to 16 DVI monitor to the DVI outputs on the rear panel of the 16x16 DVI Matrix with DVI cables.
3. Connect the included AC power cable to the power receptacle on the rear panel of the 16x16 DVI Matrix. Connect the opposite end of the cable into an available electrical outlet.

## How to Operate the 16x16 DVI Matrix

The 16x16 DVI Matrix offers a number of control options. The following methods can be used to control basic routing functions of the 16x16 DVI Matrix:

1. Front Panel Control Buttons - Pages 9 - 16
2. IR Remote Control - Pages 17 - 19
3. RS-232 Serial Control - Pages 20 - 42
4. Web Interface - Pages 43 - 58

## Wiring Diagram for the 16x16 DVI Matrix with Front Panel Push Button Control

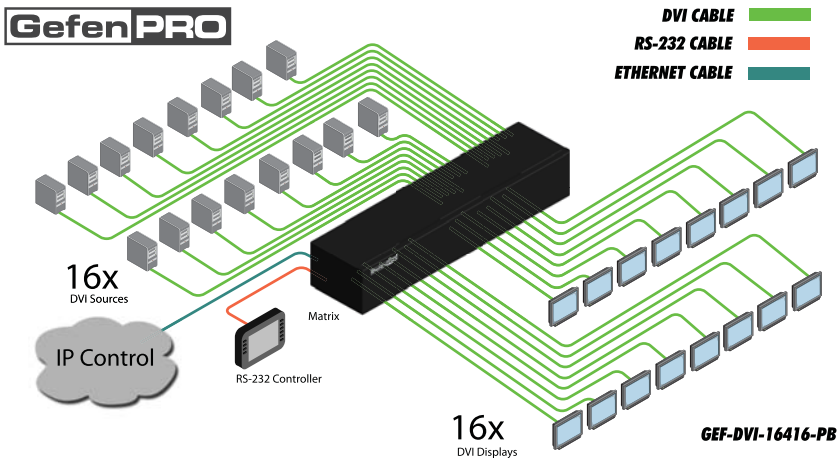

**ATTENTION:** This product should always be connected to a grounded electrical socket.

# FRONT PANEL DISPLAY

---

## Main Display

The **Main Display** of the 16x16 DVI Matrix is a 16 character 2 line display. This display will show the Standby Screen and will also be used to aid in performing routing commands. When the unit is powered on, the following screen is displayed:



After a few moments, the Standby Screen is displayed. The Standby Screen is shown below:

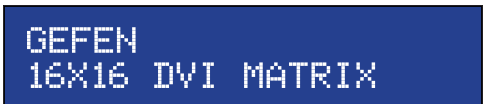

## Displaying Additional Information

Pressing the Cancel button, consecutively, will cycle through other screens such as firmware version and boot loader version:

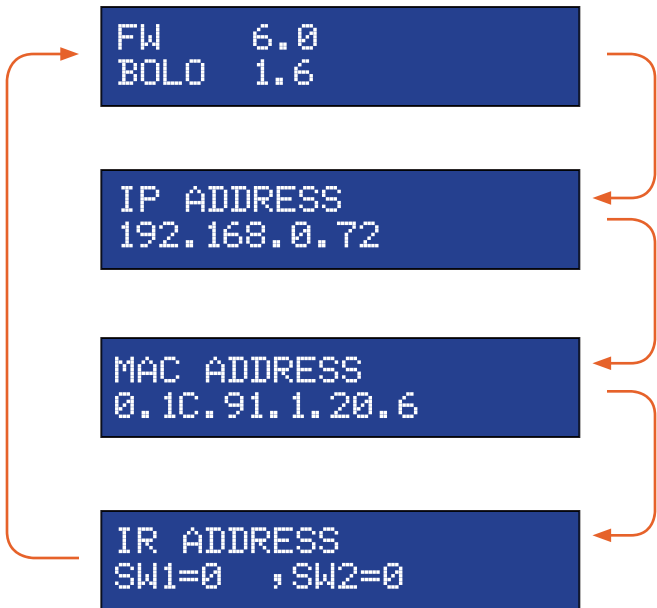

# MODE BUTTONS

## Routing Sources

In order to change current routing state:

- 1 Press Set Button to activate Routing Mode.



- 2 Press any Output button from the top row of buttons (1 - 16). One or more buttons can be selected.
- 3 Press any Input button.
- 4 Press the Set button to complete the operation. The selected inputs will be routed to the selected outputs

## System Lock Mode

Locking the Matrix prevents changes to any of the Matrix settings. This feature is useful in case any of the front panel buttons are pressed by accident. Locking the Matrix also prevents changes using the IR Remote Control Unit.

- 1 Press the Lock button to activate / deactivate the System Lock Mode.



## MODE BUTTONS

---

### Returning to Status Check Mode:

Press the Cancel button, while in any mode, to return to the Status Check Mode screen.



### How to Cycle between Information Screens:

Press the Cancel button, while in Status Check Mode, to cycle through the Information Screens.



### Activating / Deactivating Standby Mode:

Press and hold the Cancel button for 5 seconds to activate or deactivate Standby Mode.



# MODE BUTTONS

## EDID

### Saving the Downstream EDID data to Local memory:

- 1 Press EDID button once to activate DSTOLO (Downstream To Local) Mode.



- 2 Press any Output button (from the top row of buttons) to select the EDID data source.



- 3 Press any Input button (from the bottom row of buttons) to select EDID data destination.
- 4 Press the Set button to complete the operation. The system will remain in DSTOLO mode.



## MODE BUTTONS

---

### Saving the Default EDID data to Local memory:

- 1 Press the EDID button twice to activate DETOLO (Default To Local) Mode.



- 2 Press any Input button(s) to select the EDID data destination(s).



- 3 Press the Set button to complete the operation. The system will remain in DETOLO mode.



## MODE BUTTONS

---

### Saving a Routing State as a Preset

- 1 Press the Preset button **twice** on the front panel.



- 2 Press any Input button from the bottom row of buttons to select the preset location (1 - 16).
- 3 Press the Set button to load the selected preset.



## MODE BUTTONS

---

### Loading a Routing State Preset

- 1 Press the Preset button on the front panel.



- 2 Press any Input from the bottom row of buttons to select the preset (1 - 16).
- 3 Press the Set button to load the selected preset.



# MODE BUTTONS

## Masking Outputs

**Masking** is used to hide an output from displaying video. The Mask Mode allows the masking and unmasking of outputs.

- 1 Press the Mask button to active Mask Mode.



- 2 Press the output to be masked (or unmasked) by pressing the desired output from the top row of buttons on the front panel.



- 3 Press the Set button to complete the operation.



# IR REMOTE DESCRIPTION

---

## RMT-16416IR Remote Control Unit

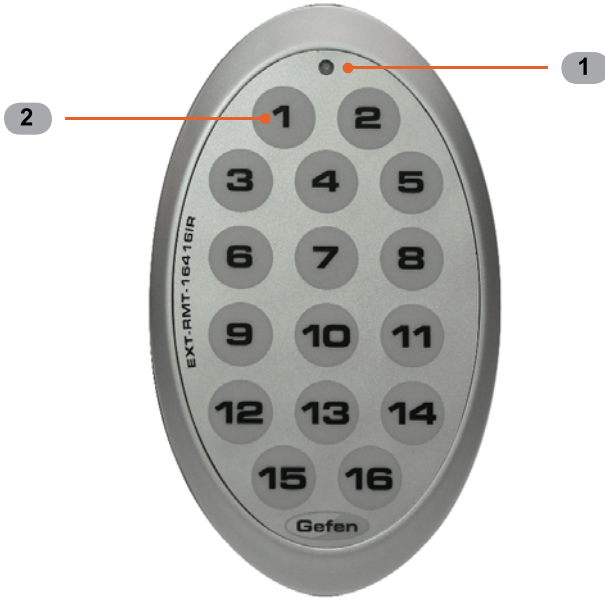

### 1 **Activity Indicator**

This LED will be activated momentarily each time a button is pressed.

### 2 **Display and Source Selection Buttons (1 - 16)**

These buttons are used to select which source is routed to a monitor.

## **Routing Sources using the Remote Control unit**

Issuing a routing command is a two step process. The first step is to select the monitor (1-16) to which the source will be routed. The second step is to select the source (1-16).

### *Example:*

*Route the source device connected to In 6 to the monitor connected to Out 4.*

1. Press button 4 (Out 4) on the IR remote control unit.
2. Press button 6 (In 6) on the IR remote control unit.

The source connected to In 6 will be routed to the monitor connected to Out 4.

# IR REMOTE INSTALLATION

---

## Installing the RMT-16416IR Battery

1. Remove the battery cover on the back of the IR Remote Control unit.
2. Insert the included battery into the open battery slot. The positive (+) side of the battery should be facing up.
3. Replace the battery cover.

The Remote Control unit ships with two batteries. One battery is required for operation and the other battery is a spare.



**Battery Slot**



**WARNING:** Risk of explosion if battery is replaced by an incorrect type. Dispose of used batteries according to the instructions.

# IR REMOTE CONFIGURATION

## How to Resolve IR Code Conflicts

In the event that IR commands from other remote controls interfere with the supplied IR Remote Control unit, changing the IR Remote Control's IR channel will fix the problem. The IR Remote Control unit has a bank of DIP switches used for setting the IR channel.

The DIP switch bank is located underneath the battery cover.

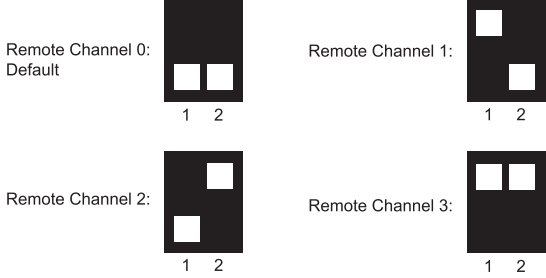

**Left:** Picture of the opened rear battery compartment of the IR remote showing the exposed DIP Switch bank between the battery chambers.

It is important that the IR channel on the Remote Control unit, matches the IR channel set on the 16x16 DVI Matrix. For example, if both DIP switches on the IR Remote Control unit are set to IR channel 0 (both DIP switches down), then the 16x16 DVI Matrix must also be set to IR channel 0. See page 40 on how to change the IR channel on the 16x16 DVI Matrix.

# RS-232 SERIAL CONTROL



Only Pins 2 (RX), 3 (TX), and 5 (Ground) are used on the RS-232 serial interface

## RS232 Settings

Bits per second ..... 19200  
Data bits ..... 8  
Parity ..... None  
Stop bits ..... 1  
Flow Control ..... None



**IMPORTANT:** When sending RS-232 commands, a *carriage return* and a *line feed* character must be included at the end of each line. Telnet Commands, Device Names, and Command Names are all case-sensitive.

## EDID Management

Command	Description
<code>#dynamic_edid</code>	Enables / disables dynamic EDID
<code>#edidbatolo</code>	Read downstream EDID and stores in any Local Input
<code>#ediddetolo</code>	Sets Local EDID to Default EDID
<code>#ediddstoba</code>	Read downstream EDID and stores in EDID Bank
<code>#ediddstolo</code>	Read downstream EDID and stores into a Local EDID
<code>#lock_edid</code>	Secures Local EDID
<code>#prbaedid</code>	Read EDID from an EDID bank and sends to serial port
<code>#prdsedid</code>	Read downstream EDID and sends to serial port
<code>#predidst</code>	Prints EDID details
<code>#prloedid</code>	Read Input Local EDID and sends to serial port

### #dynamic\_edid Command

The `#dynamic_edid` command provides the ability to route any downstream EDID to any input. When enabled, the EDID is copied to all inputs from the last selected active output. When disabled, the EDID is copied to all inputs from the first active display detected, starting from Output 1.

#### Syntax:

```
#dynamic_edid param1
```

#### Parameters:

*param1*

Value

[0 - 1]

Value	Meaning
0	Disable
1	Enable

#### Default:

Disabled

### #edidbatolo Command

The #edidbatolo command reads the downstream EDID and stores it to any local input.

#### Syntax:

```
#edidbatolo param1 param2 [param3...param9]
```

#### Parameters:

<i>param1</i>	EDID bank offset	[1 - 5]
<i>param2</i>	Input	[1 - 16]

#### Notes:

If *param2* = 0, then the EDID in the specified bank is copied to all eight inputs.

### #ediddetolo Command

The #ediddetolo command stores the Default EDID (640x480) in the specified Local EDID inputs.

#### Syntax:

```
#ediddetolo param1 param2 param3...param9
```

<i>param1</i>	Input	[1 - 16]
---------------	-------	----------

#### Notes:

If *param1* = 0, then all 16 DVI inputs will be set to the Default EDID.

### #ediddstoba Command

The #ediddstoba command reads the downstream EDID and stores it to a specified EDID bank.

#### Syntax:

```
#ediddstoba param1 param2
```

#### Parameters:

<i>param1</i>	A downstream monitor	[1 - 16]
<i>param2</i>	EDID bank offset	[1 - 5]

### #ediddstolo Command

The #ediddstolo command reads the downstream EDID and stores it to a Local EDID input.

#### Syntax:

```
#ediddstolo param1 param2 [param3...param9]
```

#### Parameters:

<i>param1</i>	A downstream monitor	[1 - 16]
<i>param2</i>	Input list	[1 - 8]

#### Notes:

If *param2* = 0, then the downstream EDID is stored to all 16 DVI inputs. If more than eight inputs need to be specified in order to receive the downstream EDID, the #ediddstolo command must be executed twice.

#### Example:

```
#ediddstolo 2 1 2 3 4 5 6 7 8 9 10 11 (not permitted!)
```

Instead, run the function twice:

```
#ediddstolo 2 1 2 3 4 5 6 7 8 9
```

```
#ediddstolo 2 10 11
```

## #lock\_edid Command

The #lock\_edid command secures the Local EDID and disables the automatic loading of the downstream EDID after the matrix is powered on.

### Syntax:

```
#lock_edid param1
```

### Parameters:

*param1* Input [0 - 1]

Value	Meaning
0	Disable
1	Enable

## #prbaedid Command

The #PRBAEDID command reads the EDID file from the specified bank and sends to serial port.

### Syntax:

```
#PRBAEDID param1
```

### Parameters:

*param1* Input [1 - 5]

## #prdsedid Command

The #prdsedid command reads the downstream EDID and sends it to the serial port.

### Syntax:

```
#prdsedid param1
```

### Parameters:

*param1* A downstream monitor [1 - 16]

### **#predidst Command**

The #predidst command reads the downstream EDID. This command displays a table containing details relating to the Local EDID and the monitor name.

Syntax:

```
#predidst
```

Parameters:

None

### **#prloedid Command**

The #prloedid command reads the local EDID of a specified input and spools it to the serial port.

Syntax:

```
#prloedid param1
```

Parameters:

*param1*

A specified Input

[1 - 16]

## IP / Telnet Configuration

Command	Description
<i>#display_telnet_welcome</i>	Set Telnet welcome message on login
<i>#ipconfig</i>	Displays all TCP/IP settings
<i>#resetip</i>	Resets IP configuration to factory settings
<i>#set_http_port</i>	Sets the Web server listening port
<i>#set_telnet_pass</i>	Prompts for password when using Telnet
<i>#set_telnet_port</i>	Sets the Telnet listening port
<i>#set_telnet_username</i>	Sets the user name for the login procedure
<i>#sgateway</i>	Sets the IP gateway address
<i>#show_telnet_pass</i>	Prompts for password when using Telnet
<i>#show_telnet_username</i>	Prompts for user name when using Telnet
<i>#show_ver_data</i>	Displays the hardware and firmware version of the matrix
<i>#sipadd</i>	Sets the IP address of the matrix
<i>#snetmask</i>	Sets the IP network mask
<i>#use_telnet_pass</i>	Use password during Telnet sessions

### #display\_telnet\_welcome Command

The #display\_telnet\_welcome command sets (enables/disables) the Telnet welcome message on login.

#### Syntax:

```
#display_telnet_welcome param1
```

#### Parameters:

*param1* State [0 - 1]

State	Meaning
0	Do not display welcome message
1	Display welcome message

### **#ipconfig Command**

The #ipconfig command displays all TCP/IP settings on the matrix.

#### Syntax:

```
#ipconfig
```

#### Parameters:

None

#### Example:

```
#ipconfig

----- TCP/IP settings -----
MAC add   = 00:1C:91:01:50:07
IP add    = 192.168.1.72
Net Mask  = 255.255.255.0
Gateway   = 192.168.2.254
Web Server Port = 80
Telnet Server Port = 23
Telnet password at login is set to ON
Telnet welcome at login is set to ON
```

### **#resetip Command**

The #resetip command resets all TCP/IP settings to factory defaults.

#### Syntax:

```
#resetip
```

#### Parameters:

None

#### Notes:

The matrix must be rebooted after executing this command.

### **#set\_http\_port Command**

The #set\_http\_port command sets the Web server listening port.

#### Syntax:

```
#set_http_port param1
```

#### Parameters:

<i>param1</i>	Port	[0 - 65535]
---------------	------	-------------

#### Default:

80

#### Notes:

The matrix must be rebooted after executing this command.

### **#set\_telnet\_pass Command**

The #set\_telnet\_pass command sets the Telnet password. The maximum length of the password is 20 characters. The password is case-sensitive.

#### Syntax:

```
#set_telnet_pass param1
```

#### Parameters:

<i>param1</i>	Password
---------------	----------

#### Default:

Admin

#### Notes:

The matrix must be rebooted after executing this command.

### **#set\_telnet\_port Command**

The #set\_telnet\_port command sets the Telnet listening port. The default port value is 23.

#### Syntax:

```
#set_telnet_port param1
```

#### Parameters:

<i>param1</i>	Port	[0 - 65535]
---------------	------	-------------

#### Notes:

The matrix must be rebooted after executing this command.

### **#set\_telnet\_username Command**

The #set\_telnet\_username command sets the Telnet user name. The maximum length of the user name is 20 characters. The user name is case-sensitive.

#### Syntax:

```
#set_telnet_username param1
```

#### Parameters:

<i>param1</i>	User name
---------------	-----------

#### Default:

Admin

#### Notes:

The matrix must be rebooted after executing this command.

### **#sgateway Command**

The #sgateway sets the IP gateway (router) address. Dot-decimal notation must be used when specifying the IP address.

#### Syntax:

```
#sgateway param1
```

#### Parameters:

*param1*                      IP gateway

#### Example:

```
#sgateway 192.168.1.1
```

#### Default:

```
192.168.1.254
```

#### Notes:

The matrix must be rebooted after executing this command.

### **#show\_telnet\_pass Command**

The #show\_telnet\_pass command shows the Telnet password for login (if required).

#### Syntax:

```
#show_telnet_pass
```

#### Default:

```
Admin
```

### **#show\_telnet\_username Command**

The #show\_telnet\_username command returns the user name required for login.

Syntax:

```
#show_telnet_username
```

Parameters:

None

Default:

Admin

### **#show\_ver\_data Command**

The #show\_ver\_data command displays the hardware and firmware version of the matrix.

Syntax:

```
#show_ver_data
```

Parameters:

None

### **#sipadd Command**

The #sipadd command sets the IP address of the matrix. Dot-decimal notation must be used when specifying the IP address.

#### Syntax:

```
#sipadd param1
```

#### Parameters:

*param1*                      IP address

#### Example:

```
#sipadd 192.168.1.72
```

#### Notes:

The matrix must be rebooted after executing this command.

### **#snetmask Command**

The #snetmask command sets the IP network mask. Dot-decimal notation must be used when specifying the IP network mask.

#### Syntax:

```
#snetmask param1
```

#### Parameters:

*param1*                      Network mask

#### Default:

```
255.255.255.0
```

#### Notes:

The matrix must be rebooted after executing this command.

### #use\_telnet\_pass Command

The #use\_telnet\_pass command requires or disables login credentials.

#### Syntax:

```
#use_telnet_pass param1
```

#### Parameters:

*param1*

State

[0 - 1]

Value	Meaning
0	Disable password
1	Enable (force) password

#### Default:

*Disabled (no password required)*

## Routing

Command	Description
<i>#callpreset</i>	Recalls a routing / mask preset
<i>#savepreset</i>	Saves the current routing/masking state to a preset
<i>r</i>	Routes the specified inputs to the specified outputs
<i>s</i>	Routes the specified input to all outputs

### **#callpreset Command**

The *#callpreset* command recalls a routing preset. Any masked outputs will also be recalled.

#### Syntax:

```
#callpreset param1
```

#### Parameters:

*param1*                                  Preset                                  [1 - 16]

### **#savepreset Command**

The *#savepreset* command saves the current routing state to the specified preset. Any masked outputs will also be saved as part of the current routing state.

#### Syntax:

```
#savepreset param1
```

#### Parameters:

*param1*                                  Preset                                  [1 - 16]

### **r Command**

The *r* command routes the specified input to the specified outputs. If *param2* is set to 0, then the specified input is routed to all outputs.

#### Syntax:

```
r param1 param2[...param17]
```

#### Parameters:

<i>param1</i>	Input	[1 - 16]
<i>param2</i>	Outputs	[1 - 16]

#### Examples:

```
r 7 3 4 5 6 10 12
```

Input 7 is routed to outputs: 3 4 5 6 10 12

```
r 2 0
```

All outputs are routed to Input 2

### **s Command**

The *s* command routes the specified input to all outputs.

#### Syntax:

```
s param1
```

#### Parameters:

<i>param1</i>	Input	[1 - 16]
---------------	-------	----------

#### Example:

```
s 1
```

All outputs are routed to Input 1

## Masking

Command	Description
<i>#maskout</i>	Masks the selected (video) output(s)
<i>#unmaskout</i>	Unmasks the selected output(s)

### #maskout Command

The #maskout command allows blanking of the specified outputs.

#### Syntax:

```
#maskout param1 param2
```

#### Parameters:

<i>param1</i>	Output	[1 - 16]
<i>param2</i>	State	[0 - 1]

Value	Meaning
0	Unmask
1	Mask

#### Notes:

The current masking state will be lost if power is interrupted or if the masking state is not saved (see #savepreset on page 34).

### **#unmaskout Command**

The #unmaskout command unmask the specified outputs. If *param1* is set to 0, then all outputs will be unmasked.

#### Syntax:

```
#unmaskout param1...param8
```

#### Parameters:

<i>param1</i>	Output	[1 - 16]
---------------	--------	----------

#### Examples:

```
#unmaskout 3 8 10
```

```
Activate outputs: 3 8 10
```

```
#unmaskout 0
```

```
Activate all outputs
```

## Miscellaneous

Command	Description
<i>#fadefault</i>	Resets the matrix to factory default routing
<i>#help</i>	Displays all available commands
<i>#lock_fo</i>	Toggles the +5V lock power state
<i>#set_input_name</i>	Specifies a name for an input
<i>#set_ir</i>	Sets the IR channel of the matrix
<i>#set_output_name</i>	Specifies a name for an output
<i>#show_temp</i>	Displays the board temperatures
<i>#show_voltage</i>	Displays the board voltages
<i>f</i>	Toggles / displays +5V input

### **#fadefault Command**

The *#fadefault* command disables the EDID lock state, sets the default routing state (1-1, 2-2, 3-3, etc.) and resets the input and output names to the default names (e.g. Output 1, Input 1).

#### Syntax:

*#fadefault*

#### Parameters:

*None*



### #set\_input\_name Command

The #set\_input\_name command provides a name to the selected input. For example, "Input 1" could be renamed as "Computer 1". The maximum string length for *param2* is 15 characters. Special characters and spaces are not permitted. If required, use the underscore character ("\_") to separate characters.

#### Syntax:

```
#set_input_name param1 param2
```

#### Parameters:

<i>param1</i>	Input	[1 - 16]
<i>param2</i>	Name	

#### Example:

```
#set_input_name 5 computer1  
computer1 is assigned to input 5
```

### #set\_ir Command

The #set\_ir set the IR channel for the matrix. The associated DIP switch settings for the IR remote control unit are returned. See page 19 for details on setting the IR channel for the IR remote control.

#### Syntax:

```
#set_ir param1
```

#### Parameters:

<i>param1</i>	Channel	[0 - 3]
---------------	---------	---------

#### Example:

```
#set_ir 2  
RMT_IR - SW1=0,SW2=1
```

### **#set\_output\_name Command**

The `#set_output_name` command provides a name to the selected output. For example, "Output 1" could be renamed as "HDDisplay". The maximum string length for *param2* is 15 characters. Special characters and spaces are not permitted. If required, use the underscore character ("\_") to separate characters.

#### Syntax:

```
#set_output_name param1 param2
```

#### Parameters:

<i>param1</i>	Output	[1 - 16]
<i>param2</i>	Name	

#### Example:

```
#set_output_name 3 display_3
display_3 is assigned to output 3
```

### **#show\_temp Command**

The `#show_temp` command displays the board temperatures to the screen.

#### Syntax:

```
#show_temp
```

#### Parameters:

None

#### Example:

```
#show_temp
Temperature near cross point top side is 53
Temperature near power supply is 54 C degree\n
Temperature near cross point bottom side is 46 C degree
Temperature on input board is 47 C degree
```

### **#show\_voltage Command**

The #show\_voltage command displays board voltages to the screen.

Syntax:

```
#show_voltage
```

Parameters:

None

Example:

```
#show_voltage
Analog voltage 3.3, measured 3265 mV
Analog voltage 1.8, measured 1781 mV
Analog voltage 1.2, measured 1180 mV
```

### **f Command**

The f command returns the state of pin 14 on the DVI input.

Syntax:

```
f param1 param2
```

Parameters:

<i>param1</i>	Input	[1 - 16]
<i>param2</i>	State	[0 - 1]

## Configuring the IP Address

The 16x16 DVI Matrix supports IP-based control using a built-in Web server or via Telnet. Before using the built-in Web server or Telnet control, the network settings for the 16x16 DVI Matrix must be configured via RS-232. The default network settings for the matrix are as follows:

IP Address: 192.168.1.72  
Subnet: 255.255.255.0  
Gateway: 192.168.2.254  
Port: 80

To access the 16x16 DVI Matrix, make sure that the computer and the matrix are within the same subnet. Otherwise use the following procedure to change the address to match your network:

1. Connect an RS-232 cable from the PC to the DVI 16x16 Matrix.
2. Launch a terminal emulation program (e.g. HyperTerminal) and use the following settings:

Baud Rate: 19200  
Data Bits: 8  
Parity: None  
Stop Bits: 1

3. Enter the following command with the IP address to be assigned to the matrix. See page 32 for details on the `#sipadd` command. Dot-decimal notation must be used when specifying the IP address.

Example: `#sipadd 192.168.1.236`



**NOTE:** If the subnet, gateway, and/or netmask need to be changed, refer to pages 30 and 32. Consult the network administrator to obtain the proper IP address and settings for this product to properly communicate on the network.

4. Power -cycle the matrix to reboot and complete the IP address change.
5. After the matrix has rebooted, the Web interface can be accessed by typing in the IP address that was specified in step 3.

Pages 43 - 58 describe the layout and operation of each function of the built-in Web server.

## View Matrix Status

### Matrix Status

Displays the current routing status of each input and output on the matrix.

The screenshot shows the 'Gefen 16x16 DVI Manager' web interface. At the top, there are navigation tabs: 'VIEW MATRIX STATUS' (selected), 'MANAGE EDIT', 'MASKING', 'IP CONFIGURATION', 'BACKUP/RESTORE', and 'POWER MANAGEMENT'. Below the tabs is a 'Matrix Status' table with 16 rows and 3 columns: 'Output', 'Input', and 'Status'. All entries in the table are 'Active'. To the right of the table is a 'Dynamic Update' section with a 'Refresh' button and an 'Auto Refresh' checkbox. Below the table is a 'Refresh' button and an 'Auto Refresh' checkbox. The interface also includes a 'Switch' section with 'Input' and 'Output' options, and a 'Presets' section with 'Save', 'Recall', and 'Rename' options.

Output	Input	Status
Output_1	Input_1	Active
Output_2	Input_1	Active
Output_3	Input_1	Active
Output_4	Input_1	Active
Output_5	Input_1	Active
Output_6	Input_1	Active
Output_7	Input_1	Active
Output_8	Input_1	Active
Output_9	Input_1	Active
Output_10	Input_1	Active
Output_11	Input_1	Active
Output_12	Input_1	Active
Output_13	Input_1	Active
Output_14	Input_1	Active
Output_15	Input_1	Active
Output_16	Input_1	Active

### Refresh

Click to refresh the Matrix Status screen

### Auto Refresh

Check this box to enable Auto Refresh. The Auto Refresh function automatically refreshes the interface every 10 seconds.

## Dynamic EDID Mode

Routes any downstream EDID to any input. See #dynamic\_edid on page 21 for details on this feature. Options: On, Off. Click the Update Dynamic EDID State button after selecting either On or Off.

The screenshot displays a web interface with two main sections highlighted by orange boxes. The top section, titled "Dynamic EDID Mode", contains a "Update Dynamic EDID State" button and two radio buttons labeled "Off" and "On", with "On" selected. Below this is a "Matrix Status" table and a "Switch Outputs" section. The "Switch Outputs" section is further detailed in a larger orange box below. This box shows a grid of checkboxes for "Outputs" (Output\_1 through Output\_16) and "Inputs" (Input\_1 through Input\_16). A "Switch" button is located at the bottom left of this section.

Output	Input	Status
Output_1	Input_1	Active
Output_2	Input_1	Active
Output_3	Input_1	Active
Output_4	Input_1	Active
Output_5	Input_1	Active
Output_6	Input_1	Active
Output_7	Input_1	Active
Output_8	Input_1	Active
Output_9	Input_1	Active
Output_10	Input_1	Active
Output_11	Input_1	Active
Output_12	Input_1	Active
Output_14	Input_1	Active
Output_15	Input_1	Active
Output_16	Input_1	Active

**Dynamic EDID Mode**  
Update Dynamic EDID State  Off  On

**Switch Outputs**

**Outputs**

Output\_1  Output\_2  Output\_3  Output\_4  Output\_5  Output\_6  
 Output\_7  Output\_8  Output\_9  Output\_10  Output\_11  Output\_12  
 Output\_13  Output\_14  Output\_15  Output\_16

**Inputs**

Input\_1  Input\_2  Input\_3  Input\_4  Input\_5  Input\_6  
 Input\_7  Input\_8  Input\_9  Input\_10  Input\_11  Input\_12  
 Input\_13  Input\_14  Input\_15  Input\_16

Switch

## Switch Outputs

Used to route the specified input to the selected output(s). To route a source, place a check mark next to each Output. Next, click the radio button next to the desired Input. Press the Switch button to apply the routing change.

# WEB INTERFACE

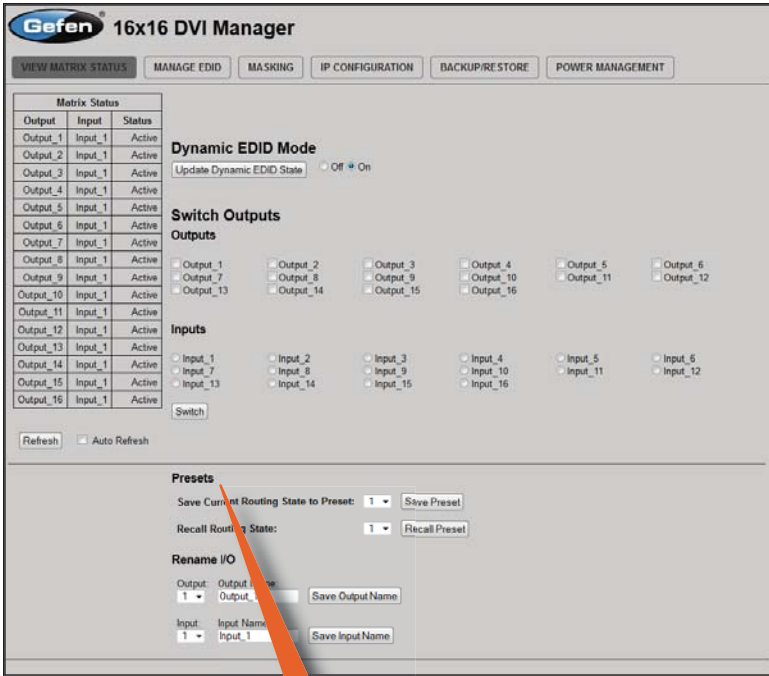

## Presets

Provides saving and recalling of routing states.

Pull-down list



## Recall Preset

Click the down-arrow on the pull-down list to select the routing state (1-16) to recall. Click the Recall Preset button to recall the preset.

## Save Preset

Click the down-arrow on the pull-down list to select the preset location (1-16). Click the Save Preset button to save the preset.

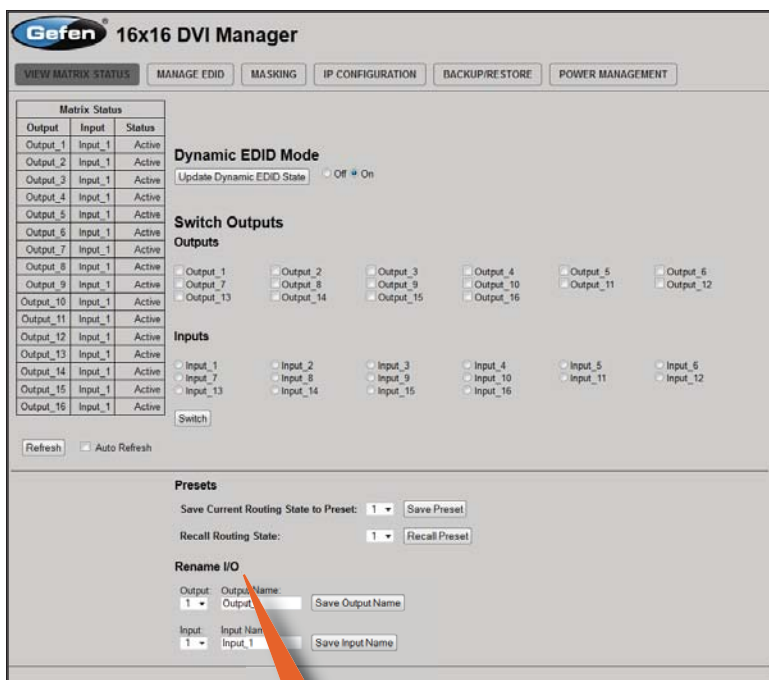

## Rename I/O

Provides custom naming of each input and output on the matrix.

**Pull-down list**

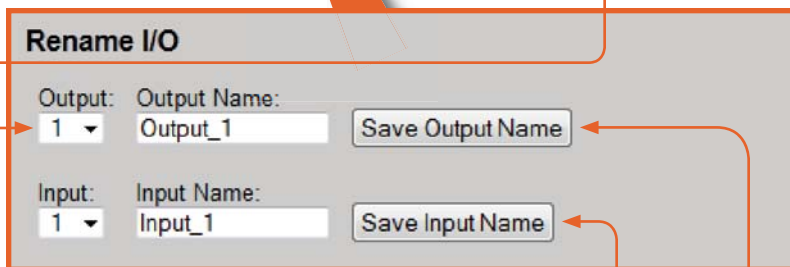

## Input

Select the DVI input to rename from the pull-down list. Type the name of the input in the Input Name field. Click the Save Input Name button to save changes. See page 40 for naming restrictions.

## Output

Select the DVI output to rename from the pull-down list. Type the name of the output in the Output Name field. Click the Save Output Name button to save changes. See page 41 for naming restrictions.

## Manage EDID

### EDID Status

Displays the current EDID status for each input on the matrix and indicates the current Lock State (see page 53 for details).

Set Input to Default EDID    Upload EDID

EDID Status - Lock State: OFF		
Input	EDID Source	Name
Input_1	Default	GEFEN_XPT_DL
Input_2	Default	GEFEN_XPT_DL
Input_3	Default	GEFEN_XPT_DL
Input_4	Default	GEFEN_XPT_DL
Input_5	Default	GEFEN_XPT_DL
Input_6	Default	GEFEN_XPT_DL
Input_7	Default	GEFEN_XPT_DL
Input_8	Default	GEFEN_XPT_DL
Input_9	Default	GEFEN_XPT_DL
Input_10	Default	GEFEN_XPT_DL
Input_11	Default	GEFEN_XPT_DL
Input_12	Default	GEFEN_XPT_DL
Input_13	Default	GEFEN_XPT_DL
Input_14	Default	GEFEN_XPT_DL
Input_15	Default	GEFEN_XPT_DL
Input_16	Default	GEFEN_XPT_DL

Refresh     Auto Refresh

**Refresh**  
Click to refresh the Matrix Status screen

### Auto Refresh

Check this box to enable Auto Refresh. Auto Refresh will automatically update the screen every 10 seconds.

## Set Input to Default EDID

### Set Input to Default EDID

Press this button from the Manage EDID screen to access this menu system.

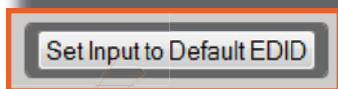

The screenshot shows the "Gefen 16x4 DVI Manager" web interface. At the top, there are navigation tabs: "VIEW MATRIX STATUS", "MANAGE EDID", "MASKING", "IP CONFIGURATION", "BACKUP/RESTORE", and "POWER MANAGEMENT". Below these are buttons for "Set Input to Default EDID", "Upload EDID", "Download EDID", "Copy EDID", and "EDID Lock State". The main content area features a table with columns "Input", "EDID Source", and "Name". All "EDID Source" and "Name" values are "Default" and "GEFEN\_XPT\_DL" respectively. Below the table is a section titled "Select Input(s) to Set to Default:" containing 16 checkboxes labeled "Input\_1" through "Input\_16". A "Set Default EDID" button is located below the checkboxes. At the bottom left, there are "Refresh" and "Auto Refresh" options. An orange arrow points from the "Set Input to Default EDID" button in the callout above to the "Set Input to Default EDID" button in the interface.

A callout box with an orange border and a white background. It contains the text "Select Input(s) to Set to Default:" followed by 16 checkboxes labeled "Input\_1" through "Input\_16". Below the checkboxes is a button labeled "Set Default EDID". An orange arrow points from this callout to the "Set Default EDID" button in the main interface below.

### Set Default EDID

Place a check mark next to the input(s) that should be set to the default EDID. Click the Set Default EDID button to apply the default EDID to the selected inputs.

## Upload EDID

### Upload EDID

Press this button from the Manage EDID screen to access this menu system.

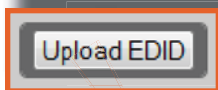

**Gefen 16x6 DVI Manager**

VIEW MATRIX STATUS | **MANAGE EDID** | MASKING | IP CONFIGURATION | BACKUP/RESTORE | POWER MANAGEMENT

Set Input to Default EDID | **Upload EDID** | Download EDID | Copy EDID | EDID Lock State

EDID Status: Lock State: OFF

Input	EDID Source	Name
Input_1	Default	GEFEN_XPT_DL
Input_2	Default	GEFEN_XPT_DL
Input_3	Default	GEFEN_XPT_DL
Input_4	Default	GEFEN_XPT_DL
Input_5	Default	GEFEN_XPT_DL
Input_6	Default	GEFEN_XPT_DL
Input_7	Default	GEFEN_XPT_DL
Input_8	Default	GEFEN_XPT_DL
Input_9	Default	GEFEN_XPT_DL
Input_10	Default	GEFEN_XPT_DL
Input_11	Default	GEFEN_XPT_DL
Input_12	Default	GEFEN_XPT_DL
Input_13	Default	GEFEN_XPT_DL
Input_14	Default	GEFEN_XPT_DL
Input_15	Default	GEFEN_XPT_DL
Input_16	Default	GEFEN_XPT_DL

Select Input(s) to Upload to:

Input\_1     Input\_2     Input\_3     Input\_4     Input\_5  
 Input\_6     Input\_7     Input\_8     Input\_9     Input\_10  
 Input\_11     Input\_12     Input\_13     Input\_14     Input\_15  
 Input\_16

Upload EDID File

Load EDID file

Select Input(s) to Upload to:

Input\_1     Input\_2     Input\_3     Input\_4  
 Input\_6     Input\_7     Input\_8     Input\_9  
 Input\_11     Input\_12     Input\_13     Input\_14  
 Input\_16

Upload EDID File

Load EDID file

### Load EDID file

Place a check mark next to the input(s) that will receive the EDID data from the file. The EDID file must be in .bin format. Click the Browse button to locate the EDID on the computer. Click the Load EDID file button to upload the EDID file to the matrix.

## Download EDID

### Download EDID

Press this button from the Manage EDID screen to access this menu system.

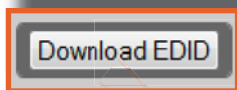

**Gefen 16x16 D Manager**

VIEW MATRIX STATUS   MANAGE EDID   MASKING   IP CONFIGURATION   BACKUP/RESTORE   POWER MANAGEMENT

Set Input to Default EDID   Upload EDID   **Download EDID**   Copy EDID   EDID Lock State

EDID Status : Lock State: OFF

Input	EDID Source	Name
Input_1	Default	GEFEN_XPT_DL
Input_2	Default	GEFEN_XPT_DL
Input_3	Default	GEFEN_XPT_DL
Input_4	Default	GEFEN_XPT_DL
Input_5	Default	GEFEN_XPT_DL
Input_6	Default	GEFEN_XPT_DL
Input_7	Default	GEFEN_XPT_DL
Input_8	Default	GEFEN_XPT_DL
Input_9	Default	GEFEN_XPT_DL
Input_10	Default	GEFEN_XPT_DL
Input_11	Default	GEFEN_XPT_DL
Input_12	Default	GEFEN_XPT_DL
Input_13	Default	GEFEN_XPT_DL
Input_14	Default	GEFEN_XPT_DL
Input_15	Default	GEFEN_XPT_DL
Input_16	Default	GEFEN_XPT_DL

**Select EDID to Download**

Output\_1    Output\_2    Output\_3    Output\_4    Output\_5  
 Output\_6    Output\_7    Output\_8    Output\_9    Output\_10  
 Output\_11    Output\_12    Output\_13    Output\_14    Output\_15  
 Output\_16

Download EDID File to PC

**Select EDID to Download**

Output\_1    Output\_2    Output\_3    Output\_4  
 Output\_6    Output\_7    Output\_8    Output\_9  
 Output\_11    Output\_12    Output\_13    Output\_14  
 Output\_16

Download EDID File to PC

### Download EDID File to PC

Select the radio button next to the output, containing the EDID to be downloaded. Click the Download EDID File to PC button to confirm the change. The downloaded EDID file will be in .bin format.

## Copy EDID

### Copy EDID

Press this button from the Manage EDID screen to access this menu system.

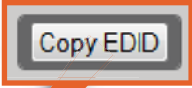

Copy EDID

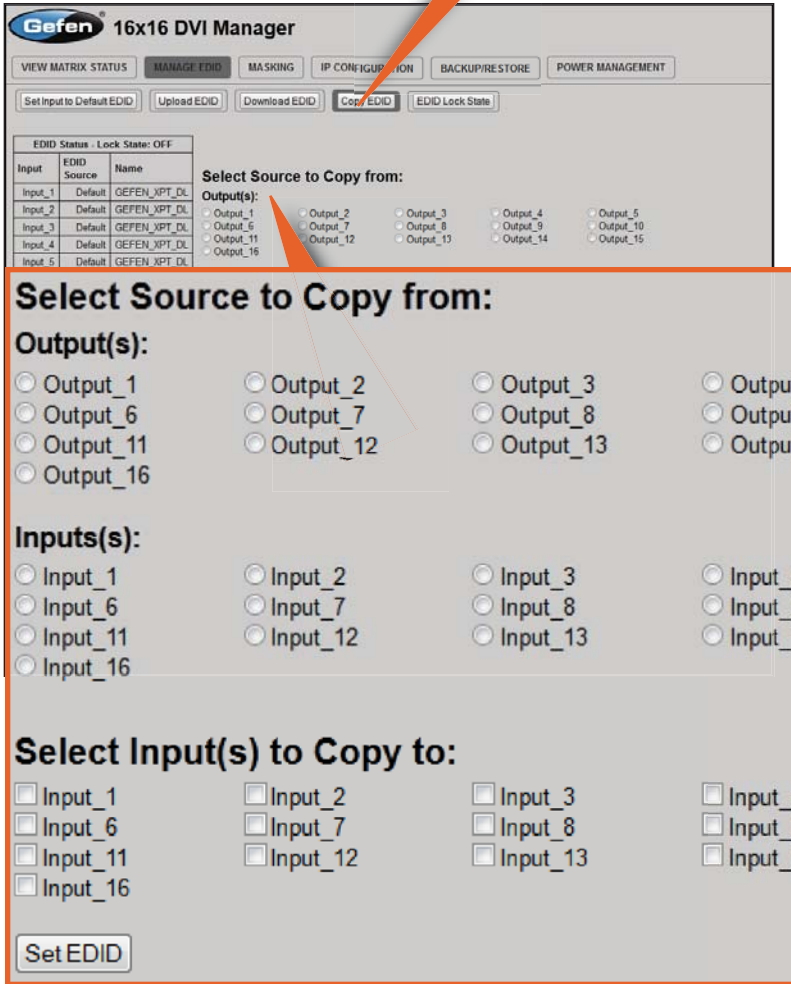

**Gefen 16x16 DVI Manager**

VIEW MATRIX STATUS   **MANAGE EDID**   MASKING   IP CONFIGURATION   BACKUP/RESTORE   POWER MANAGEMENT

Set Input to Default EDID   Upload EDID   Download EDID   **Copy EDID**   EDID Lock State

Input	EDID Source	Name
Input_1	Default	GEFEN_XPT_DL
Input_2	Default	GEFEN_XPT_DL
Input_3	Default	GEFEN_XPT_DL
Input_4	Default	GEFEN_XPT_DL
Input_5	Default	GEFEN_XPT_DL

EDID Status: Lock State: OFF

**Select Source to Copy from:**

**Output(s):**

Output\_1    Output\_2    Output\_3    Output\_4    Output\_5  
 Output\_6    Output\_7    Output\_8    Output\_9    Output\_10  
 Output\_11    Output\_12    Output\_13    Output\_14    Output\_15  
 Output\_16

**Inputs(s):**

Input\_1    Input\_2    Input\_3    Input\_4  
 Input\_6    Input\_7    Input\_8    Input\_9  
 Input\_11    Input\_12    Input\_13    Input\_14  
 Input\_16

**Select Input(s) to Copy to:**

Input\_1    Input\_2    Input\_3    Input\_4  
 Input\_6    Input\_7    Input\_8    Input\_9  
 Input\_11    Input\_12    Input\_13    Input\_14  
 Input\_16

Set EDID

### Select Source to Copy from / Select Input(s) to Copy to

Click the radio button next to the input or output containing the EDID to copy. Note that only a single input or output can be selected at a time. Place a check mark next to the input(s) where the EDID will be copied. Click the Set EDID button to confirm the operation.

## EDID Lock State

### EDID Lock State

Press this button from the Manage EDID screen to access this menu system.

EDID Lock State

The screenshot shows the 'Gefen 16x16 DVI Manager' web interface. At the top, there are navigation tabs: VIEW MATRIX STATUS, MANAGE EDID, MASKING, IP CONFIGURATION, BACKUP/RESTORE, and POWER MANAGEMENT. Below these are buttons for 'Set Input to Default EDID', 'Upload EDID', 'Download EDID', 'Copy EDID', and 'EDID Lock State'. The 'EDID Lock State' button is highlighted with an orange callout box. Below the navigation is a table with columns 'Input', 'EDID Source', and 'Name'. The table lists 16 inputs, all with 'Default' as the source and 'GEFEN\_XPT\_DL' as the name. Below the table is a section titled 'EDID Lock State' containing an 'Update EDID Lock State' button and two radio buttons labeled 'Off' and 'On'. A second orange callout box highlights this section, showing a larger view of the 'Update EDID Lock State' button and the radio buttons.

Input	EDID Source	Name
Input_1	Default	GEFEN_XPT_DL
Input_2	Default	GEFEN_XPT_DL
Input_3	Default	GEFEN_XPT_DL
Input_4	Default	GEFEN_XPT_DL
Input_5	Default	GEFEN_XPT_DL
Input_6	Default	GEFEN_XPT_DL
Input_7	Default	GEFEN_XPT_DL
Input_8	Default	GEFEN_XPT_DL
Input_9	Default	GEFEN_XPT_DL
Input_10	Default	GEFEN_XPT_DL
Input_11	Default	GEFEN_XPT_DL
Input_12	Default	GEFEN_XPT_DL
Input_13	Default	GEFEN_XPT_DL
Input_14	Default	GEFEN_XPT_DL
Input_15	Default	GEFEN_XPT_DL
Input_16	Default	GEFEN_XPT_DL

EDID Status: Lock State: OFF

Update EDID Lock State  Off  On

EDID Lock State

Update EDID Lock State  Off  On

### Update EDID Lock State

Secures the Local EDID and disables the automatic loading of the downstream EDID after the Matrix is powered on. Select the radio button next to the Off or On option then click the Update EDID Lock State button to apply the change.

The EDID Lock State has no effect when the Dynamic EDID function is activated.

## Masking

### Matrix Mask Status / Change

Displays the current masking status for each output.

The screenshot shows the Gefen 16x16 DVI Manager interface. A window titled "Matrix Mask Status/Change" is open, displaying a table of output masking status. The table has four columns: "Output", "Input", "Status", and "Click to:". The "Click to:" column contains buttons that toggle between "Active" and "Mask".

Output	Input	Status	Click to:
Output_1	Input_1	Mask	Active
Output_2	Input_2	Active	Mask
Output_3	Input_3	Mask	Active
Output_4	Input_2	Active	Mask
Output_5	Input_2	Active	Mask
Output_6	Input_2	Active	Mask
Output_7	Input_2	Mask	Active
Output_8	Input_2	Active	Mask
Output_9	Input_2	Active	Mask
Output_10	Input_2	Active	Mask
Output_11	Input_2	Active	Mask
Output_12	Input_2	Active	Mask
Output_13	Input_2	Active	Mask
Output_14	Input_2	Active	Mask
Output_15	Input_2	Active	Mask
Output_16	Input_2	Active	Mask

Below the table are two controls: a "Refresh" button and an "Auto Refresh" checkbox (which is currently unchecked).

### Mask

Click the Mask button to mask the selected output. If the output is already masked then the button will read "Active" (enabled). Click the ("Active") button again to toggle the masking state to "Mask" (disabled).

## IP Configuration

### IP Settings

Assigns IP address, subnet, gateway, HTTP listening port, and Telnet port. Note that the MAC address can not be changed. Click the Save button to apply changes. The matrix must be rebooted for the changes to take effect.

**Gefen 16x16 DVI Manager**

VIEW MATRIX STATUS    MANAGE EDID    MASKING    **IP CONFIGURATION**    BACKUP/RESTORE    POWER MANAGEMENT

### IP Settings

MAC Address: 00:1C:91:01:0F:FF  
IP Address: 192.168.2.236 (default: 192.168.7.75)  
Subnet: 255.255.255.0 (default: 255.255.255.0)  
Gateway: 192.168.2.1 (default: 192.168.7.254)  
HTTP Port: 80 (default: 80)  
Telnet Port: 23 (default: 23)

Reset IP Configuration to Defaults:

### Telnet Login Settings

User Name: Admin (default: Admin)  
Password: Admin (default: Admin)  
Force Login:   
Welcome message:

### IP Settings

MAC Address: 00:1C:91:01:0F:FF  
IP Address: 192.168.2.236 (default: 192.168.7.75)  
Subnet: 255.255.255.0 (default: 255.255.255.0)  
Gateway: 192.168.2.1 (default: 192.168.7.254)  
HTTP Port: 80 (default: 80)  
Telnet Port: 23 (default: 23)

Reset IP Configuration to Defaults:

### Telnet Login Settings

User Name: Admin (default: Admin)  
Password: Admin (default: Admin)  
Force Login:   
Welcome message:

### Telnet Login Settings

Sets the user name and password for Telnet sessions to the matrix. Click the Save button to apply changes.

## Backup / Restore

The Backup / Restore feature for the 16x16 DVI Matrix is not currently implemented and will be available in a future release of the firmware.

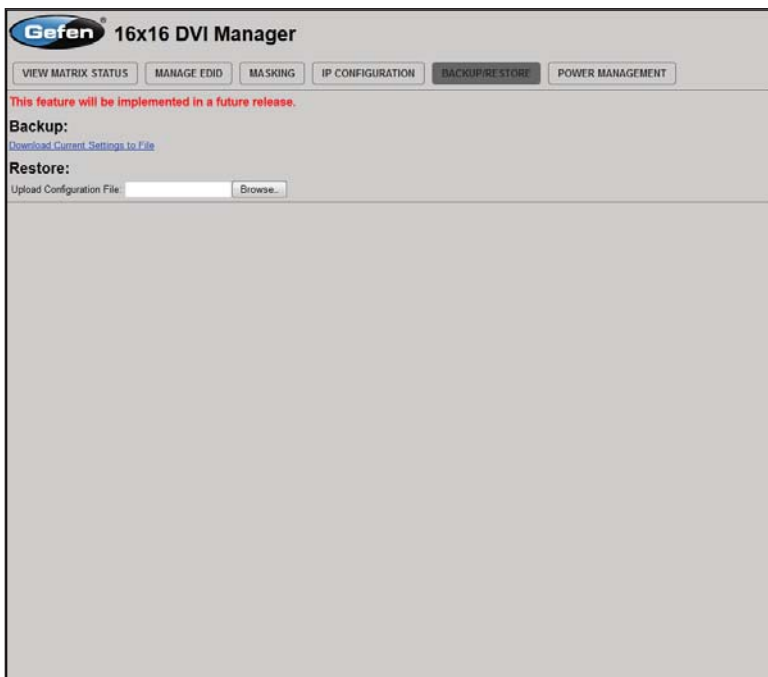

## Power Management

### Power Status

Enabling this feature will store the +5V status for that input prior to shutting down the matrix. This preserves the +5V state when the unit is restarted.

**Gefen 16x16 DVI Manager**

VIEW MATRIX STATUS | MAN...

Warning: Use caution when a...

Power Status - Lock State: OFF

Input	5 volt	Click to:
Input_1	ON	OFF
Input_2	ON	OFF
Input_3	OFF	ON
Input_4	ON	OFF
Input_5	ON	ON
Input_6	OFF	ON
Input_7	OFF	ON
Input_8	OFF	ON
Input_9	OFF	ON
Input_10	OFF	ON
Input_11	OFF	ON
Input_12	OFF	ON
Input_13	OFF	ON
Input_14	OFF	ON
Input_15	OFF	ON
Input_16	OFF	ON

Refresh  Auto Refresh

Save Changes

**Power Lock State**

Update Power Lock State \* ON

### Refresh

Click to refresh the Power Status screen

### Save Changes

Click to save the power lock status.

### Power State

The current power state is listed under the column titled "5 Volt". Click these buttons to toggle the input power state.

### Auto Refresh

Check this box to automatically update the screen every 10 seconds.

# WEB INTERFACE

**Gefen 16x16 DVI Manager**

VIEW MATRIX STATUS    MANAGE EDID    MASKING    IP CONFIGURATION    BACKUP/RESTORE    **POWER MANAGEMENT**

**Warning: Use caution when applying power to inputs. It may damage your equipment.**

Power Status - Lock State: OFF

Input	5 volt	Click to:
Input_1	ON	OFF
Input_2	ON	OFF
Input_3	OFF	ON
Input_4	ON	OFF
Input_5	OFF	ON
Input_6	OFF	ON
Input_7	OFF	ON
Input_8	OFF	ON
Input_9	OFF	ON
Input_10	OFF	ON
Input_11	OFF	ON
Input_12	OFF	ON
Input_13	OFF	ON
Input_14	OFF	ON
Input_15	OFF	ON
Input_16	OFF	ON

Refresh     Auto Refresh

Save Changes

**Power Lock State**

Update Power Lock State     Off     On

**Power Lock State**

Update Power Lock State     Off     On

## Power Lock State

In the case of an accidental power loss to the matrix, the +5V state for each input can be preserved.

Set the specified Power Status buttons (see previous page) and click the radio button next to ON. Click the Update Power Lock State button to apply changes.

By default, this option is set to Off.

# FIRMWARE UPDATE

---

## Firmware Update Procedure

The following items are required to update firmware:

- RS-232 Terminal (e.g. Windows-based PC running HyperTerminal).
- RS-232 cable (do not use a null-modem cable)
- Firmware files: DVI16x16 and GEFMTXFP

To begin the update procedure the matrix Boot Loader must be activated. To activate the Boot Loader please follow the procedure below:

1. Power-on the matrix.
2. Connect an RS-232 cable to the PC and open the terminal program using the following settings:

Baud rate: 19200  
Stop bits: 1  
Data bits: 8  
Flow control: None

3. Type the command: `#activebolo`

Two options will be provided:

To download the file DVI16x16 please type the command 'activebolo 0'  
To download the file GEFMTXFP please type the command 'activebolo 1'

4. Type the command: `#activebolo 0`

This will begin the update process of the main board.

5. Once the Boot Loader is activated the following message should appear:
6. Press [1] on the computer keyboard to begin downloading program to the temporary memory

```
DVI16x16 Boot Loading
===== Main Menu =====
Download new program ----- 1
Cancel ----- 2
=====
```

7. Press [1] on the computer keyboard to begin downloading program to the temporary memory.

## FIRMWARE UPDATE

---

8. A message will appear in the terminal program:

```
Waiting for the file to be sent ... (press 'a' to abort)
```

9. In Hyperterminal, click Transfer > Send file...
10. Click Browse... and select the .BIN file corresponding to the boot loader which was activated. In this first case, the file should start with DVI16x16.
11. Select Ymodem for the protocol.
12. Press Send on the Send File dialog box.
13. A message will appear in Hyperterminal:

```
Programming Completed Successfully!
```

14. The unit will exit the boot loader screen and return to the standard Hyperterminal window.
15. Repeat steps 3 - 12 for the file GEFMTXFP.

## **RACK MOUNT SAFETY INFORMATION**

---

- a. Maximum recommended ambient temperature: 45 °C (104 °F).
- b. Increase the air flow as needed to maintain the recommended temperature inside the rack.
- c. Do not exceed maximum weight loads for the rack. Install heavier equipment in the lower part of the rack to maintain stability.
- d. Connect a bonding wire between an approval safety ground stud on the chassis.

## SPECIFICATIONS

---

Maximum Pixel Clock .....	165 MHz
Input Video Signal .....	1.2 Volts p-p
Video Input Connectors.....	(16) DVI-I 29-pin, female (digital only)
Video output Connectors.....	(16) DVI-I 29-pin, female (digital only)
IR Extender.....	3.5 mm mini-stereo
RS-232 Interface.....	DB-9 serial, female
Ethernet (IP control) port.....	RJ-45 (100BaseT)
Power Supply.....	100 ~ 240 V AC (x2 for redundancy)
Power Consumption .....	90 Watts (max)
Operating Temperature.....	0 °C ~ 45 °C / 32 °F ~ 104 °F
Storage Temperature.....	-20 °C ~ 60 °C / -4 °F ~ 140 °F
Relative Humidity.....	20% ~ 90% (no condensation)
Dimensions .....	17.25" W x 3.5" H x 12" D
Rack-mountable .....	2U rack space, rack ears included
Shipping Weight .....	30 lbs.

## WARRANTY

---

Gefen warrants the equipment it manufactures to be free from defects in material and workmanship.

If equipment fails because of such defects and Gefen is notified within two (2) years from the date of shipment, Gefen will, at its option, repair or replace the equipment, provided that the equipment has not been subjected to mechanical, electrical, or other abuse or modifications. Equipment that fails under conditions other than those covered will be repaired at the current price of parts and labor in effect at the time of repair. Such repairs are warranted for ninety (90) days from the day of reshipment to the Buyer.

This warranty is in lieu of all other warranties expressed or implied, including without limitation, any implied warranty or merchantability or fitness for any particular purpose, all of which are expressly disclaimed.

1. Proof of sale may be required in order to claim warranty.
2. Customers outside the US are responsible for shipping charges to and from Gefen.
3. Copper cables are limited to a 30 day warranty and cables must be in their original condition.

The information in this manual has been carefully checked and is believed to be accurate. However, Gefen assumes no responsibility for any inaccuracies that may be contained in this manual. In no event will Gefen be liable for direct, indirect, special, incidental, or consequential damages resulting from any defect or omission in this manual, even if advised of the possibility of such damages. The technical information contained herein regarding the features and specifications is subject to change without notice.

For the latest warranty coverage information, refer to the Warranty and Return Policy under the Support section of the Gefen Web site at [www.gefen.com](http://www.gefen.com).

## PRODUCT REGISTRATION

**Please register your product online by visiting the Register Product page under the Support section of the Gefen Web site.**

## LICENSING

---

lwIP is licenced under the BSD licence:

Copyright (c) 2001-2004 Swedish Institute of Computer Science.  
All rights reserved.

Redistribution and use in source and binary forms, with or without modification, are permitted provided that the following conditions are met:

1. Redistributions of source code must retain the above copyright notice, this list of conditions and the following disclaimer.
2. Redistributions in binary form must reproduce the above copyright notice, this list of conditions and the following disclaimer in the documentation and/or other materials provided with the distribution.
3. The name of the author may not be used to endorse or promote products derived from this software without specific prior written permission.

THIS SOFTWARE IS PROVIDED BY THE AUTHOR ``AS IS'' AND ANY EXPRESS OR IMPLIED WARRANTIES, INCLUDING, BUT NOT LIMITED TO, THE IMPLIED WARRANTIES OF MERCHANTABILITY AND FITNESS FOR A PARTICULAR PURPOSE ARE DISCLAIMED. IN NO EVENT SHALL THE AUTHOR BE LIABLE FOR ANY DIRECT, INDIRECT, INCIDENTAL, SPECIAL, EXEMPLARY, OR CONSEQUENTIAL DAMAGES (INCLUDING, BUT NOT LIMITED TO, PROCUREMENT OF SUBSTITUTE GOODS OR SERVICES; LOSS OF USE, DATA, OR PROFITS; OR BUSINESS INTERRUPTION) HOWEVER CAUSED AND ON ANY THEORY OF LIABILITY, WHETHER IN CONTRACT, STRICT LIABILITY, OR TORT (INCLUDING NEGLIGENCE OR OTHERWISE) ARISING IN ANY WAY OUT OF THE USE OF THIS SOFTWARE, EVEN IF ADVISED OF THE POSSIBILITY OF SUCH DAMAGE.









**20600 Nordhoff St., Chatsworth CA 91311**  
**1-800-545-6900 818-772-9100 fax: 818-772-9120**  
**www.gefenpro.com support@gefenpro.com**

