



Use this manual if you encounter any problems, or have any questions about your product.



Looking for valuable information, such as essential points on shooting (Tutorials)

This website introduces convenient functions, ways of usage, and setting examples. Refer to the website when you set up your camera. (Another window will open.)



ZV-1 accessories compatibility information

This website provides the accessories compatibility information. (Another window will open.)

Names of parts/Icons and indicators

[Identifying parts](#)

Basic operations

[Using the control wheel](#)

[Using MENU items](#)

[Assigning frequently used functions to buttons \(Custom Key\)](#)

[Using Fn \(Function\) button \(Function menu\)](#)

[How to use the keyboard](#)

Icons and indicators

[List of icons on the monitor](#)

[Switching the screen display \(while shooting/during playback\)](#)

[DISP Button](#)

Preparing the camera

[Checking the camera and the supplied items](#)

Charging the battery pack

[Inserting/removing the battery pack](#)

[Charging the battery pack while it is inserted in the camera](#)

[Charging by connecting to a computer](#)

[Battery life and number of recordable images](#)

[Supplying power from a wall outlet \(wall socket\)](#)

[Notes on the battery pack](#)

[Notes on charging the battery pack](#)

Inserting a memory card (sold separately)

[Inserting/removing a memory card](#)

[Memory cards that can be used](#)

[Notes on memory card](#)

[Setting language, date and time](#)

[In-Camera Guide](#)

Shooting

[Shooting still images](#)

Focusing

[Focus Mode](#)

Auto focus

[Focus Area](#)

[Phase detection AF](#)

[Focus Standard](#)

- [AF/MF control](#)
- [Focusing on eyes \(Face/Eye AF Set.\)](#)
- [Tracking subject \(Tracking function\)](#)
- [Focus Frame Color](#)
- [Pre-AF \(still image\)](#)
- [AF Area Auto Clear](#)
- [Disp. cont. AF area](#)
- [Phase Detect. Area](#)
- [Circ. of Focus Point](#)

Manual focus

- [Manual Focus \(Set Focus\)](#)
- [Direct manual focus \(DMF\)](#)
- [Focus Magnifier](#)
- [MF Assist \(still image\)](#)
- [Focus Magnif. Time](#)
- [Initial Focus Mag_\(still image\)](#)
- [Peaking Setting](#)

Selecting a drive mode (Continuous shooting/Self-timer)

- [Drive Mode](#)
- [Cont. Shooting](#)
- [Self-timer](#)
- [Self-timer\(Cont\)](#)
- [Cont. Bracket](#)
- [Single Bracket](#)
- [Indicator during bracket shooting](#)
- [WB bracket](#)
- [DRO Bracket](#)
- [Bracket Settings](#)

Taking pictures of yourself by monitoring the screen

- [Self-portrait/ -timer](#)

Interval shooting

- └ [Interval Shoot Func.](#)

Using touch functions

- └ [Touch Operation](#)
- └ [Func. of Touch Operation: Touch Shutter](#)
- └ [Func. of Touch Operation: Touch Focus](#)
- └ [Func. of Touch Operation: Touch Tracking](#)

Selecting still image size/image quality

- └ [File Format \(still image\)](#)
- └ [JPEG Quality \(still image\)](#)
- └ [JPEG Image Size \(still image\)](#)
- └ [Aspect Ratio \(still image\)](#)
- └ [Panorama: Size](#)
- └ [Panorama: Direction](#)

Selecting a shooting mode

- └ [Changing shooting modes \(Shoot Mode\)](#)
- └ [Intelligent Auto](#)
- └ [About Scene Recognition](#)
- └ [Program Auto](#)
- └ [Aperture Priority](#)
- └ [Shutter Priority](#)
- └ [Manual Exposure](#)
- └ [Bulb shooting](#)
- └ [Sweep Panorama](#)
- └ [Scene Selection](#)
- └ [Recall \(Camera Settings1/Camera Settings2\)](#)
- └ [HFR \(High Frame Rate\): Exposure Mode](#)
- └ [Movie: Exposure Mode](#)
- └ [Intelligent Auto \(movie\)](#)

Controlling the exposure/metering modes

[Exposure Comp.](#)

[Exposure Set. Guide](#)

[ND Filter](#)

[Metering Mode](#)

[Face Priority in Multi Metering](#)

[AE lock](#)

[Exp.comp.set](#)

[Zebra Setting](#)

Switching the shooting style

[Product Showcase Set](#)

[Background Defocus](#)

Correcting brightness and contrast automatically

[D-Range Optimizer \(DRO\)](#)

[Auto HDR](#)

Selecting the ISO sensitivity

[ISO](#)

Using the zoom

[The zoom features available with this product](#)

[Zoom](#)

[Zoom Setting](#)

[About zoom scale](#)

[Zoom Speed](#)

White balance

[White Balance](#)

[Priority Set in AWB](#)

[Capturing a standard white color to set the white balance \(custom white balance\)](#)

Setting how to process images

[Creative Style](#)

[Picture Effect](#)

[Soft Skin Effect](#)

[Auto Object Framing \(still image\)](#)

[Color Space \(still image\)](#)

Shutter settings

[Shutter Type \(still image\)](#)

[Release w/o Card](#)

Reducing blur

[SteadyShot \(still image\)](#)

Noise reduction

[Long Exposure NR \(still image\)](#)

[High ISO NR \(still image\)](#)

Face detection

[Regist. Faces Priority](#)

[Smile Shutter](#)

[Face Registration \(New Registration\)](#)

[Face Registration \(Order Exchanging\)](#)

[Face Registration \(Delete\)](#)

Using the flash

[Using flash \(sold separately\)](#)

[Flash Mode](#)

[Flash Comp.](#)

Recording movies

[Shooting movies](#)

[Movie w/ shutter](#)

[Movie recording formats](#)

[File Format \(movie\)](#)

[Record Setting \(movie\)](#)

[Shooting super-slow-motion movies \(HFR Settings\)](#)

[Capturing still images while recording movies \(Dual Rec\)](#)

[Quality \(Dual Rec\)](#)

[Img. Size \(Dual Rec\)](#)

[Auto Dual Rec](#)

[Proxy Recording](#)

[Audio Recording](#)

[Audio Level Display](#)

[Audio Rec Level](#)

[Wind Noise Reduct.](#)

[Picture Profile](#)

[Gamma Disp. Assist](#)

[Auto Slow Shutter \(movie\)](#)

[Initial Focus Mag. \(movie\)](#)

[AF drive speed \(movie\)](#)

[AF Tracking Sens. \(movie\)](#)

[SteadyShot \(movie\)](#)

[TC/UB Settings](#)

[TC/UB Disp. Switch](#)

[MOVIE Button](#)

[Marker Display \(movie\)](#)

[Marker Settings \(movie\)](#)

[4K Output Select \(movie\)](#)

[REC Lamp](#)

Viewing

Viewing images

[Playing back still images](#)

[Enlarging an image being played back \(Enlarge Image\)](#)

[Rotating recorded images automatically \(Display Rotation\)](#)

[Rotating an image \(Rotate\)](#)

[Playing back panoramic images](#)

[Enlarge Initial Mag.](#)

[Enlarge Initial Position](#)

[Playing back movies](#)

[Motion Shot Video](#)

[Motion Interval ADJ](#)

[Volume Settings](#)

[Photo Capture](#)

[Playing back images on the image index screen \(Image Index\)](#)

[Switching between still images and movies \(View Mode\)](#)

[Display as Group](#)

[Cont. PB for Interval](#)

[PB Speed for Interval](#)

[Playing back images using slideshow \(Slide Show\)](#)

Editing images

[Beauty Effect](#)

Protecting data

[Protecting images \(Protect\)](#)

Setting Rating function

[Rating](#)

[Rating Set \(Custom Key\)](#)

Designating images for printing (DPOF)

[Specifying images to be printed \(Specify Printing\)](#)

Deleting images

[Deleting a displayed image](#)

[Deleting multiple selected images \(Delete\)](#)

[Delete confirm.](#)

Viewing images on a TV

[Viewing images on a TV using an HDMI cable](#)

Customizing the camera

Registering frequently used functions

[Memory \(Camera Settings1/Camera Settings2\)](#)

Customizing MENU (My Menu)

[Add Item](#)

- [Sort Item](#)
- [Delete Item](#)
- [Delete Page](#)
- [Delete All](#)
- [Display From My Menu](#)

Checking images before/after recording

- [Auto Review](#)
- [Live View Display](#)

Monitor settings

- [Grid Line](#)
- [Monitor Brightness](#)
- [Power OFF w/ monitor](#)
- [Auto Monitor OFF](#)
- [Bright Monitoring](#)

Memory card settings

- [Format](#)
- [Select REC Folder](#)
- [New Folder](#)
- [File/Folder Settings \(still image\)](#)
- [File Settings \(movie\)](#)
- [Display Media Info.](#)
- [Recover Image DB](#)

Camera settings

- [Audio signals](#)
- [Write Date \(still image\)](#)
- [Tile Menu](#)
- [Power Save Start Time](#)
- [Auto Power OFF Temp.](#)
- [NTSC/PAL Selector](#)
- [HDMI Settings: HDMI Resolution](#)

[HDMI Settings: 24p/60p Output \(movie\)_ \(Only for 1080 60i compatible models\)](#)

[HDMI Settings: HDMI Info. Display](#)

[HDMI Settings: TC Output \(movie\)](#)

[HDMI Settings: REC Control \(movie\)](#)

[HDMI Settings: CTRL FOR HDMI](#)

[USB Connection](#)

[USB LUN Setting](#)

[USB Power Supply](#)

[Language](#)

[Date/Time Setup](#)

[Area Setting](#)

[Version](#)

[Demo Mode](#)

Initializing the camera

[Setting_Reset](#)

Using network functions

Connecting this product and a Smartphone

[Imaging_Edge Mobile](#)

[Ctrl w/ Smartphone](#)

[Controlling the camera using an Android smartphone \(QR Code\)](#)

[Controlling the camera using an Android smartphone \(SSID\)](#)

[Controlling the camera using an iPhone or iPad \(QR Code\)](#)

[Controlling the camera using an iPhone or iPad \(SSID\)](#)

Transferring images to a Smartphone

[Send to Smartphone Func.: Send to Smartphone](#)

[Send to Smartphone Func.: Sending Target \(proxy movies\)](#)

[Send to Smartphone Func.: Cnct. during Power OFF](#)

Reading location information from a smartphone

[Location Info. Link Set.](#)

Using a remote commander with Bluetooth communication

[Bluetooth Rmt Ctrl](#)

Transferring images to a TV

[View on TV](#)

Changing the network settings

[Airplane Mode](#)

[Wi-Fi Settings: WPS Push](#)

[Wi-Fi Settings: Access Point Set.](#)

[Wi-Fi Settings: Display Wi-Fi Info.](#)

[Wi-Fi Settings: SSID/PW Reset](#)

[Bluetooth Settings](#)

[Edit Device Name](#)

[Reset Network Set.](#)

Using a computer

[Recommended computer environment](#)

Connecting/disconnecting the camera

[Connecting to a computer](#)

[Disconnecting the camera from the computer](#)

Managing/editing images on a computer

[Introduction to computer software \(PlayMemories Home/Imaging Edge\)](#)

[Importing images to the computer without using computer software](#)

[Send to Computer](#)

[Operating the camera from a computer \(PC Remote Function\)](#)

List of MENU items

[Using MENU items](#)

Camera Settings¹

[File Format \(still image\)](#)

[JPEG Quality \(still image\)](#)

[JPEG Image Size \(still image\)](#)

[Aspect Ratio \(still image\)](#)

[Panorama: Size](#)

Panorama: Direction
Long Exposure NR (still image)
High ISO NR (still image)
Color Space (still image)
Changing shooting modes (Shoot Mode)
Intelligent Auto
Scene Selection
Drive Mode
Bracket Settings
Interval Shoot Func.
Recall (Camera Settings1/Camera Settings2)
Memory (Camera Settings1/Camera Settings2)
Focus Mode
Focus Area
Focusing on eyes (Face/Eye AF Set.)
Pre-AF (still image)
Focus Frame Color
AF Area Auto Clear
Disp. cont. AF area
Phase Detect. Area
Circ. of Focus Point
Manual Focus (Set Focus)
Exposure Comp.
ISO
ND Filter
Metering Mode
Face Priority in Multi Metering
Flash Mode
Flash Comp.
Exp.comp.set

- [White Balance](#)
- [Priority Set in AWB](#)
- [D-Range Optimizer \(DRO\)](#)
- [Auto HDR](#)
- [Creative Style](#)
- [Picture Effect](#)
- [Picture Profile](#)
- [Soft Skin Effect](#)
- [Focus Magnifier](#)
- [Focus Magnif. Time](#)
- [Initial Focus Mag_\(still image\)](#)
- [MF Assist \(still image\)](#)
- [Peaking Setting](#)
- [Product Showcase Set](#)
- [Face Registration \(New Registration\)](#)
- [Face Registration \(Order Exchanging\)](#)
- [Face Registration \(Delete\)](#)
- [Regist. Faces Priority](#)
- [Smile Shutter](#)
- [Auto Object Framing_\(still image\)](#)
- [Self-portrait/ -timer](#)

Camera Settings2

- [Movie: Exposure Mode](#)
- [HFR \(High Frame Rate\): Exposure Mode](#)
- [File Format \(movie\)](#)
- [Record Setting \(movie\)](#)
- [Shooting super-slow-motion movies \(HFR Settings\)](#)
- [Quality\(Dual Rec\)](#)
- [Img. Size\(Dual Rec\)](#)
- [Auto Dual Rec](#)

- [Proxy Recording](#)
- [AF drive speed \(movie\)](#)
- [AF Tracking Sens. \(movie\)](#)
- [Auto Slow Shutter \(movie\)](#)
- [Initial Focus Mag. \(movie\)](#)
- [Audio Recording](#)
- [Audio Rec Level](#)
- [Audio Level Display](#)
- [Wind Noise Reduct.](#)
- [SteadyShot \(movie\)](#)
- [Marker Display \(movie\)](#)
- [Marker Settings \(movie\)](#)
- [REC Lamp](#)
- [Movie w/ shutter](#)
- [Shutter Type \(still image\)](#)
- [Release w/o Card](#)
- [SteadyShot \(still image\)](#)
- [Zoom Setting](#)
- [Zoom Speed](#)
- [DISP Button](#)
- [Zebra Setting](#)
- [Grid Line](#)
- [Exposure Set. Guide](#)
- [Live View Display](#)
- [Auto Review](#)
- [Assigning frequently used functions to buttons \(Custom Key\)](#)
- [Using Fn \(Function\) button \(Function menu\)](#)
- [Func. of Touch Operation: Touch Shutter](#)
- [Func. of Touch Operation: Touch Focus](#)
- [Func. of Touch Operation: Touch Tracking](#)

[MOVIE Button](#)

[Audio signals](#)

[Write Date \(still image\)](#)

Network

[Send to Smartphone Func.: Send to Smartphone](#)

[Send to Smartphone Func.: Sending Target \(proxy movies\)](#)

[Send to Smartphone Func.: Cnct. during Power OFF](#)

[Send to Computer](#)

[View on TV](#)

[Ctrl w/ Smartphone](#)

[Operating the camera from a computer \(PC Remote Function\)](#)

[Airplane Mode](#)

[Wi-Fi Settings: WPS Push](#)

[Wi-Fi Settings: Access Point Set.](#)

[Wi-Fi Settings: Display Wi-Fi Info.](#)

[Wi-Fi Settings: SSID/PW Reset](#)

[Bluetooth Settings](#)

[Location Info. Link Set.](#)

[Bluetooth Rmt Ctrl](#)

[Edit Device Name](#)

[Reset Network Set.](#)

Playback

[Protecting images \(Protect\)](#)

[Rotating an image \(Rotate\)](#)

[Deleting multiple selected images \(Delete\)](#)

[Rating](#)

[Rating Set \(Custom Key\)](#)

[Specifying images to be printed \(Specify Printing\)](#)

[Beauty Effect](#)

[Photo Capture](#)

- [Enlarging an image being played back \(Enlarge Image\)](#)
- [Enlarge Initial Mag.](#)
- [Enlarge Initial Position](#)
- [Motion Interval ADJ](#)
- [Cont. PB for Interval](#)
- [PB Speed for Interval](#)
- [Playing back images using slideshow \(Slide Show\)](#)
- [Switching between still images and movies \(View Mode\)](#)
- [Playing back images on the image index screen \(Image Index\)](#)
- [Display as Group](#)
- [Rotating recorded images automatically \(Display Rotation\)](#)

Setup

- [Monitor Brightness](#)
- [Gamma Disp. Assist](#)
- [Volume Settings](#)
- [Tile Menu](#)
- [Delete confirm.](#)
- [Auto Monitor OFF](#)
- [Power Save Start Time](#)
- [Power OFF w/ monitor](#)
- [Auto Power OFF Temp.](#)
- [NTSC/PAL Selector](#)
- [Touch Operation](#)
- [Demo Mode](#)
- [TC/UB Settings](#)
- [HDMI Settings: HDMI Resolution](#)
- [HDMI Settings: 24p/60p Output \(movie\) \(Only for 1080 60i compatible models\)](#)
- [HDMI Settings: HDMI Info. Display](#)
- [HDMI Settings: TC Output \(movie\)](#)
- [HDMI Settings: REC Control \(movie\)](#)

[HDMI Settings: CTRL FOR HDMI](#)

[4K Output Select \(movie\)](#)

[USB Connection](#)

[USB LUN Setting](#)

[USB Power Supply](#)

[Language](#)

[Date/Time Setup](#)

[Area Setting](#)

[Format](#)

[Select REC Folder](#)

[New Folder](#)

[File/Folder Settings \(still image\)](#)

[File Settings \(movie\)](#)

[Recover Image DB](#)

[Display Media Info.](#)

[Version](#)

[Setting Reset](#)

My Menu

[Add Item](#)

[Sort Item](#)

[Delete Item](#)

[Delete Page](#)

[Delete All](#)

[Display From My Menu](#)

Precautions/This product

[Precautions](#)

[On cleaning](#)

[Number of recordable images](#)

[Recordable movie times](#)

[Using the battery charger abroad](#)

[AVCHD format](#)

[License](#)

[Specifications](#)

[Trademarks](#)

If you have problems

[Troubleshooting](#)

[Self-diagnosis display](#)

[Warning messages](#)

5-016-934-11(1) Copyright 2020 Sony Corporation

Identifying parts

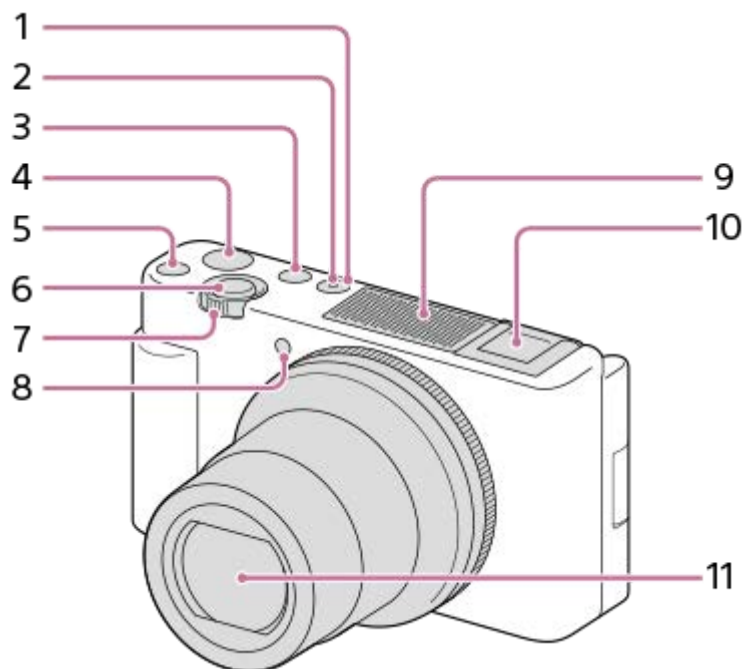

1. ON/OFF (Power) button
2. Power/Charge lamp
3. MODE (Mode) button
4. MOVIE (Movie) button
5. C1 (Custom 1) button
6. Shutter button
7. For shooting: W/T (zoom) lever
For viewing:  (Index) lever/Playback zoom lever
8. Self-timer lamp/Recording lamp
9. Internal microphone

- Do not cover this part during movie recording. Doing so may cause noise or lower the volume.

10. Multi Interface Shoe

- Some accessories may not go in all the way and protrude backward from the Multi Interface Shoe. However, when the accessory reaches the front end of the shoe, the connection is completed.
- For details on compatible accessories for the Multi Interface Shoe, visit the Sony website, or consult your Sony dealer or local authorized Sony service facility. Accessories for the Accessory Shoe can also be used. Operations with other manufacturers' accessories are not guaranteed.

 Multi
Interface Shoe

 Accessory Shoe

11. Lens

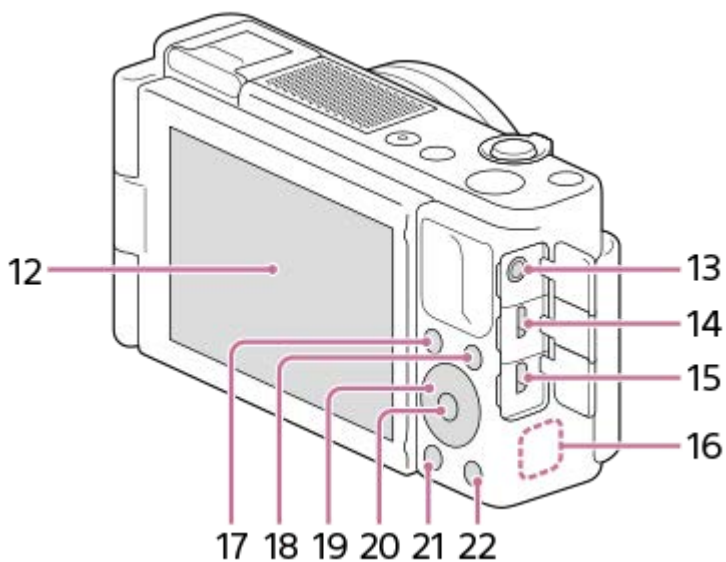

12. Monitor/Touch panel

- You can adjust the monitor to an easily viewable angle and shoot from any position.

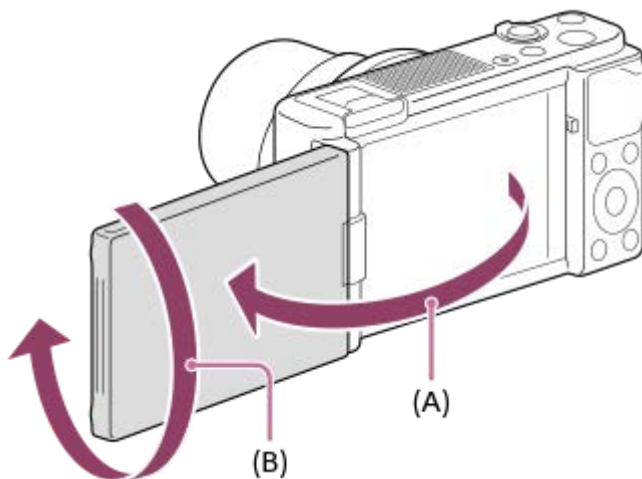

(A): Approx. 176°

(B): Approx. 270°

- If you open the monitor from the closed position with the screen facing inwards, the camera will turn on.
- To choose whether or not the camera turns off when the monitor is closed with the screen facing inwards, select MENU →  (Setup) → [Power OFF w/ monitor].
- You may not be able to adjust the monitor angle depending on the type of a tripod you use. In such a case, release the tripod screw once to adjust the monitor angle.
- Do not apply excessive force when opening, closing, or rotating the monitor. Doing so may cause a malfunction.

13. (Microphone) jack

- When an external microphone is connected, the built-in microphone turns off automatically. When the external microphone is a plugin-power type, the power of the microphone is supplied by the camera.

14. Multi/Micro USB Terminal

- This terminal supports Micro USB-compatible devices.
- For details on compatible accessories for the Multi/Micro USB Terminal, visit the Sony website, or consult your Sony dealer or local authorized Sony service facility.



15. HDMI micro jack

16. Wi-Fi/Bluetooth antenna (built-in)

17. For shooting: Fn (Function) button

For viewing:  (Send to Smartphone) button

18. MENU button

- 19. Control wheel
- 20. Center button
- 21.  (Playback) button
- 22. C2/ (Custom button 2/Delete) button

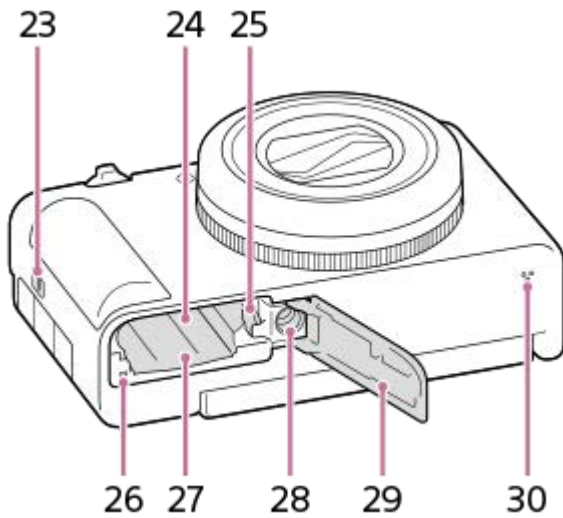

- 23. Hook for strap
- 24. Battery insertion slot
- 25. Battery lock lever
- 26. Access lamp
- 27. Memory card slot
- 28. Tripod socket hole
Supports 1/4-20 UNC screws

- Use a tripod with a screw less than 5.5 mm (7/32 inches) long. Otherwise, you cannot firmly secure the camera, and damage to the camera may occur.

- 29. Battery/Memory card cover
- 30. Speaker

Using the wind screen (supplied)

Use the wind screen to reduce wind noise picked up by the internal microphone when recording a movie. Remove the shoe cap from the camera, and then attach the wind screen to the Multi Interface Shoe.

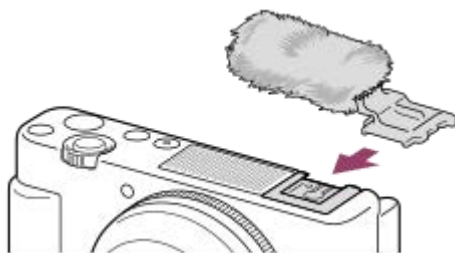



Note

- When attaching the wind screen, make sure that the wind screen does not get caught in the Multi Interface Shoe.
- Be careful not to lose the shoe cap when you remove it from the camera.

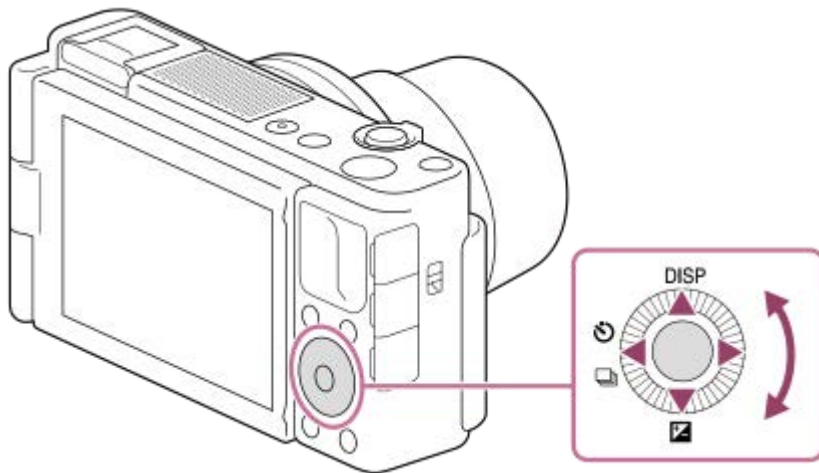
Using the control wheel



- You can select setting items by turning or pressing the top/bottom/left/right side of the control wheel. Your selection is determined when you press the center of the control wheel.
- The DISP (Display Setting),  (Exposure Comp.), and  /  (Drive Mode) functions are assigned to the top/bottom/left side of the control wheel. In addition, you can assign selected functions to the left/right side and the center of the control wheel.
- During playback, you can display the next/previous image by pressing the right/left side of the control wheel or by turning the control wheel.

Related Topic

- [Assigning frequently used functions to buttons \(Custom Key\)](#)

Using MENU items

You can change settings related to all the camera operations including shooting, playback, and operating method. You can also execute camera functions from the MENU.

- 1 Press the MENU button to display the menu screen.

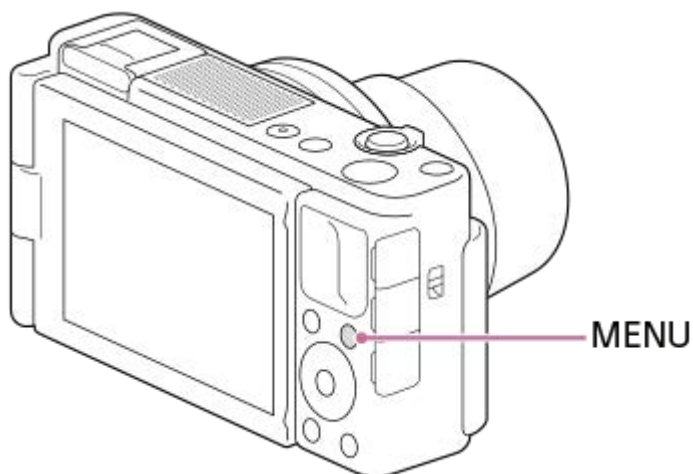

- 2 Select the desired setting you want to adjust using the top/bottom/left/right sides of the control wheel or by turning the control wheel, and then press the center of the control wheel.

- Select a MENU tab (A) at the top of the screen, and press the left/right side of the control wheel to move to another MENU tab.
- You can move to the next MENU tab by pressing the Fn button.
- You can go back to the previous screen by pressing the MENU button.





- 3 Select the desired setting value, and press the center to confirm your selection.

Related Topic

- [Tile Menu](#)
- [Add Item](#)
- [Display From My Menu](#)

Assigning frequently used functions to buttons (Custom Key)

You can use the custom key function to assign the functions you use most frequently to easily operable keys. This lets you skip the process of selecting items from MENU, so you can recall the functions more quickly. You can also assign [Not set] to easily operable keys to prevent accidental operation.

You can separately assign functions to custom keys for the still image shooting mode ( Custom Key), movie shooting mode ( Custom Key), and playback mode ( Custom Key).

- Assignable functions vary depending on the keys.

You can assign functions to the following keys.

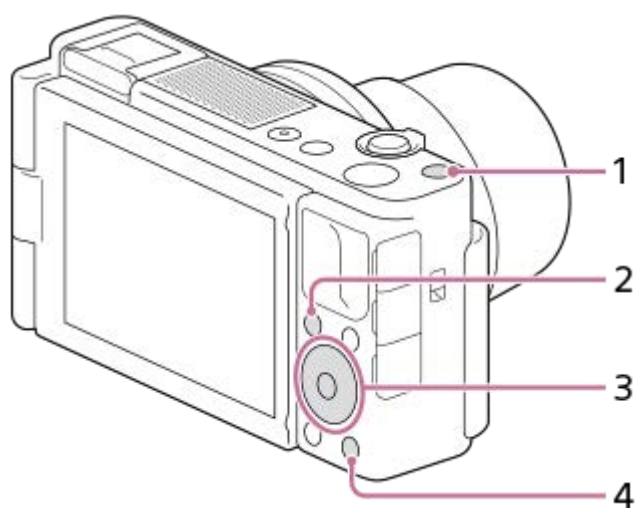





1. Custom Button 1
2. Fn/  Button
3. Center Button /Left Button/Right Button
4. Custom Button 2

Hint







- You can recall functions more quickly by using the Function menu to configure each setting directly from the Fn button, along with the custom keys. Refer to the related functions under “Related Topic” at the bottom of this page.

The following is the procedure for assigning the [Eye AF] function to the C2 button.

- 1** MENU →  2 (Camera Settings2) → [ Custom Key].
 - If you want to assign a function to recall while shooting movies, select [ Custom Key]. If you want to assign a function to recall while playing back images, select [ Custom Key].
- 2** Move to the [Rear] screen using the left/right side of the control wheel. Then, select [Custom Button 2] and press the center of the control wheel.
- 3** Press the left/right side of the control wheel until [Eye AF] is displayed. Select [Eye AF], and then press the center.

- If you press the C2 button in the still image shooting mode and eyes are detected, [Eye AF] will activate, and the camera will focus on the eyes. Shoot images while holding down the C2 button.

Note

- If you assign [Follow Custom ()] to a custom key using [ Custom Key], but the function is one that is unavailable in the movie shooting mode such as [ JPEG Quality] or [Flash Mode], the function will not be recalled when you press the key in the movie shooting mode.
- If you assign [Follow Custom ( / )] to a custom key using [ Custom Key], the camera will switch to the shooting mode and recall the assigned function when you press the key in the playback mode.

Related Topic

- [Using Fn \(Function\) button \(Function menu\)](#)

Using Fn (Function) button (Function menu)

The Function menu is a menu of 12 functions that is displayed at the bottom of the screen when you press the Fn (Function) button in the shooting mode. You can access frequently used functions more quickly by registering them to the function menu.



Hint

- You can register twelve functions to the Function menus for still image shooting and movie shooting, respectively.
- You can recall functions more quickly by using the custom key function to assign frequently used functions to desired keys, along with the function menu. Refer to the related functions under “Related Topic” at the bottom of this page.

1 Press the Fn (Function) button in shooting mode.

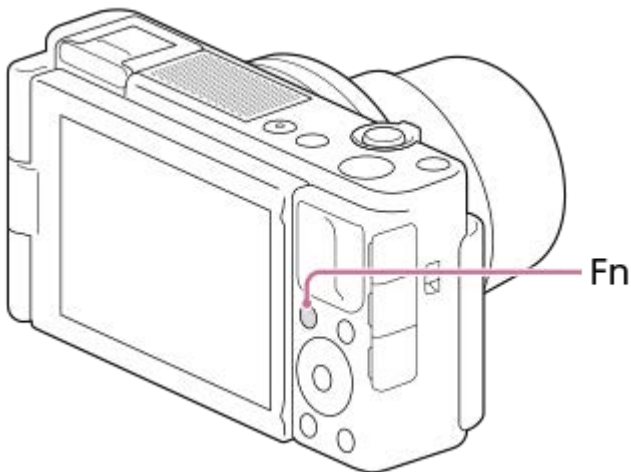

2 Select the desired function by pressing the top/bottom/left/right side of the control wheel.

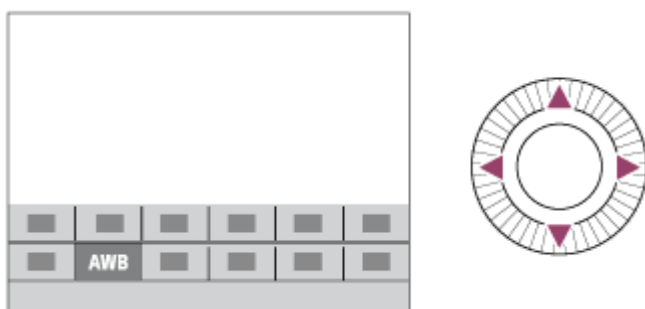

- 3 Select the desired setting by turning the control wheel, and press the center of the control wheel.

To adjust settings from the dedicated setting screens

Select the desired function in step 2, then press the center of the control wheel. The dedicated setting screen for the function will appear. Follow the operating guide **(A)** to adjust settings.

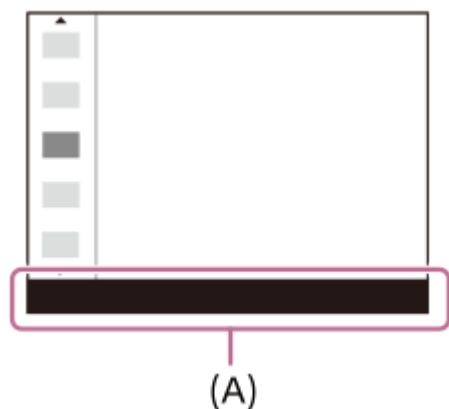

To change the functions in the function menu (Function Menu Set.)

The following is the procedure for changing [Drive Mode] in the still image function menu to [Grid Line].

- To change the movie function menu, select a movie function menu item in Step 2.
1. MENU → 2 (Camera Settings2) → [Function Menu Set.].
 2. Select (Drive Mode) from among the twelve still image function menu items using the top/bottom/left/right side of the control wheel, and then press the center.
 3. Move to the [Display/Auto Review] screen using the left/right side of the control wheel. Then, select [Grid Line] and press the center of the control wheel.
 - (Grid Line) will be displayed in the former location of (Drive Mode) in the function menu.

Related Topic

- [Assigning frequently used functions to buttons \(Custom Key\)](#)

How to use the keyboard

When manual character entry is required, a keyboard is displayed on the screen.

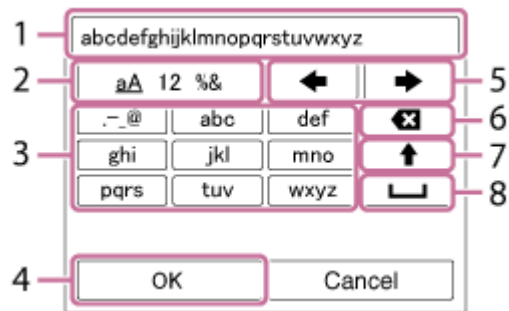

Move the cursor on desired key using the control wheel, then press the center to enter.

1. Input box

The characters you entered are displayed.

2. Switch character types

Each time you press this key, the character type will switch between alphabet letters, numerals and symbols.

3. Keyboard

Each time you press this key, the characters corresponding to that key will be displayed one-by-one in order.

For example: If you want to enter “abd”

1. Press the key for “abc” once to display “a.”
2. Press “➡” (the right-pointing arrow in the “Move cursor” area, marked as No.5).
3. Press the key for “abc” twice to display “b.”
4. Press the key for “def” once to display “d.”

4. Finalize

Finalizes the entered characters.

5. Move cursor

Moves the cursor in the input box to the right or left.

6. Delete

Deletes the character preceding the cursor.

7. ⬆ (upward-pointing arrow)

Switches the next character to a capital or lowercase letter.

8. ␣ (space)

Enters a space.

- To cancel input, select [Cancel].

File format of movies



Record setting of movies

120p 100p 60p 50p 60i 50i 30p 25p 24p

Frame rate of movies

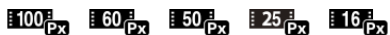

Proxy Recording

240fps 250fps 480fps 500fps 960fps 1000fps

Frame rate for HFR shooting



Flash charge in progress



Setting Effect OFF



SteadyShot off/on, Camera shake warning



Smart Zoom/ClearImage Zoom/Digital Zoom



PC Remote



Bright Monitoring



No audio recording of movies



Remote control



Wind Noise Reduct.



HFR REC Timing

Assist 5-Log2 Assist 5-Log3 Assist HLG 709 Assist HLG 2020

Gamma Disp. Assist



Touch Shutter



Focus Cancel



Tracking Cancel

Spot Focus

Performing [Spot Focus]



Bluetooth connection available / Bluetooth connection unavailable



Connected to smartphone / Not connected to smartphone



Obtaining location information / Location information cannot be obtained



Airplane Mode



Overheating warning

20 sec

Remaining recordable time when overheating warning is displayed



Database file full / Database file error



Product Showcase Set

3. Battery



Remaining battery



Remaining battery warning



USB power supply

4. Shooting settings



Drive Mode



Flash Mode



Flash Comp.



Focus Mode



Focus Area

JPEG RAW RAW+J

File Format



Metering Mode



White Balance (Auto, Preset, Underwater Auto, Custom, Color temperature, Color filter)



D-Range Optimizer /Auto HDR



Creative Style /Contrast, saturation, and sharpness



Smile detection sensitivity indicator

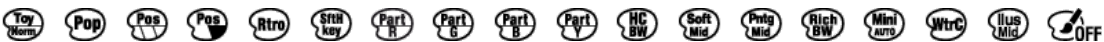

Picture Effect

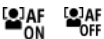

Face/Eye Priority in AF



Soft Skin Effect

5. Focus indicator/exposure settings



Focus indicator

1/250

Shutter speed

F3.5

Aperture value



Background Defocus



Exposure compensation/Metered Manual

ISO400

ISO AUTO

 **ISO400**

ISO sensitivity



AE lock



ND Filter is activated

6. Guides/other

 **Tracking Cancel**

Guide display for tracking

 **Select Focus Point On/Off**

Guide display for setting Focus Area

 **Focus Cancel**

Guide display for canceling focusing

 **Return to Shooting Setting**

Guide display for HFR shooting

 **Switch Av/Tv**

Guide display for switching aperture value and shutter speed



Control wheel function



Guide display for [Background Defocus] on the C1 button (only with [Intelligent Auto] or [ Intelligent Auto])



Guide display for [Product Showcase Set] on the C2 button (only with [Intelligent Auto] or [ Intelligent Auto])



Bracket indicator



Spot metering area

C:32:00

Self-diagnosis display



Exposure Setting Guide



Shutter speed indicator



Aperture indicator



Histogram

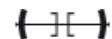

Digital level gauge

STBY REC

Movie recording standby/Movie recording in progress

1:00:12

Actual movie recording time (hours: minutes: seconds)



Audio Level Display



REC Control

00:00:00.00

Time code (hours: minutes: seconds. frames)

00 00 00 00

User Bit

Icons on the playback screen

Single-image playback

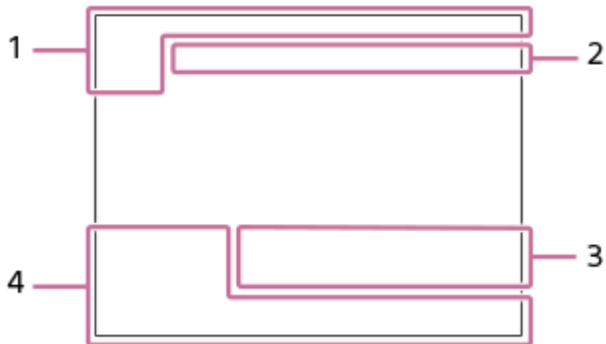

Histogram display

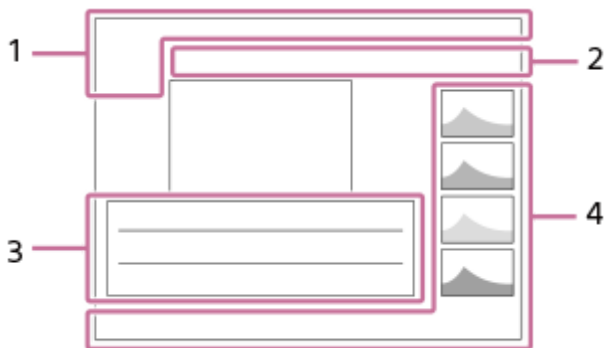

1. Basic information



View Mode



Rating



Protect

DPOF

DPOF set



Auto object framing image

3/7

File number/Number of images in the view mode



Remaining battery



Display as Group



Proxy movie included

2. Camera settings

Refer to "Icons on the shooting screen."

3. Shooting settings



Picture Effect error



Auto HDR error

HLG

HDR recording (Hybrid Log-Gamma)

Refer to “Icons on the shooting screen” for other icons displayed in this area.

4. Image information



Latitude/longitude information

2020-1-1 10:37PM

Date of recording



100-0003

Folder number - file number

C0003

Movie file number



Histogram (Luminance/R/G/B)

Switching the screen display (while shooting/during playback)

You can change the display contents on the screen.

1 Press the DISP (Display Setting) button.

- Each time you press the DISP button, the screen display changes.
- The displayed contents and their position are just a guideline, and may differ from the actual display.

During shooting

Display All Info. → No Disp. Info. → Histogram → Level → Graphic Display → Display All Info.

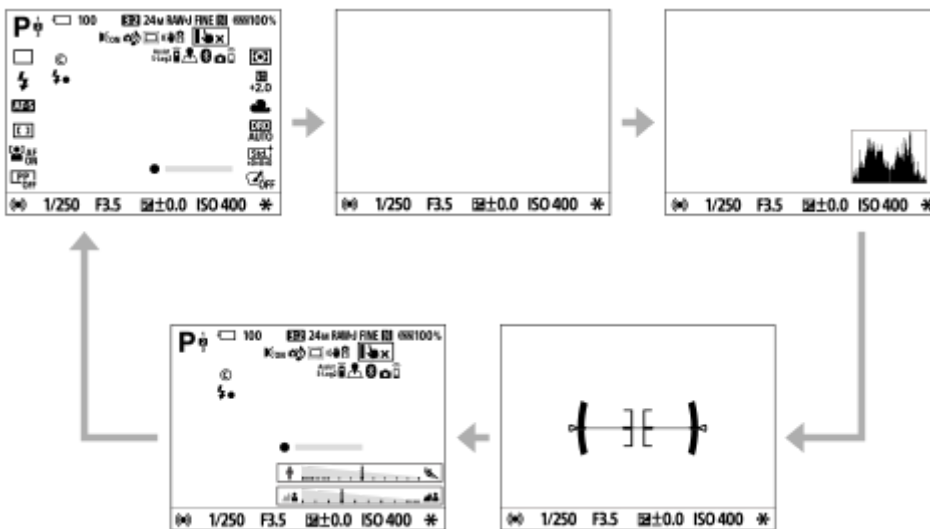

During playback

Display Info. → Histogram → No Disp. Info. → Display Info.

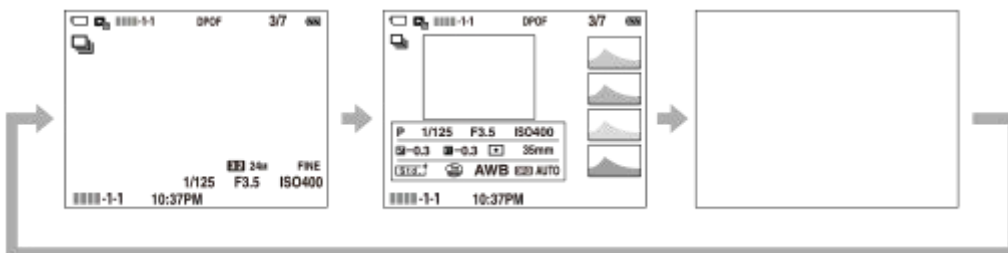

- If the image has an overexposed or underexposed area, the corresponding section will blink on the histogram display (overexposed/underexposed warning).
- The settings for playback are also applied in [Auto Review].

Histogram display

A histogram shows the luminance distribution, displaying how many pixels there are by luminance. It shows darker toward the left and brighter toward the right.

The histogram changes depending on the exposure compensation.

A peak at the right or left end of the histogram indicates that the image has an overexposed or underexposed area, respectively. You cannot correct such defects using a computer after shooting. Perform exposure compensation before shooting as necessary.



(A): Pixel count
 (B): Brightness

Note

- [Histogram] is not displayed during panorama shooting.
- The information in the histogram display does not indicate the final photograph. It is information about image displayed on the screen. The final result depends on the aperture value, etc.
- The histogram display is extremely different between shooting and playback in the following cases:
 - When the flash is used
 - When shooting a low luminance subject such as a night scene

Hint

- To change the display modes that are switched when you press the DISP button, select MENU → 2 (Camera Settings2) → [DISP Button] and change the setting.

Related Topic

- [DISP Button](#)

DISP Button

Allows you to set the screen display modes that can be selected using DISP (Display Setting) in shooting mode.

1 MENU →  2 (Camera Settings2) → [DISP Button] → desired setting → [Enter].

The items marked with ✓ (check mark) are available.

Menu item details

Graphic Display :

Shows basic shooting information. Graphically shows the shutter speed and aperture value.

Display All Info. :

Shows recording information.

No Disp. Info. :

Does not show recording information.

Histogram :

Displays the luminance distribution graphically.

Level :

Indicates whether the product is level in both the front-back **(A)** and horizontal **(B)** directions. When the product is level in either direction, the indicator turns to green.

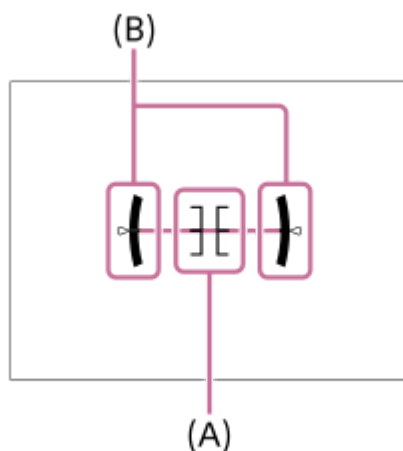

Note

- If you tilt the product forward or backward by a large degree, the level error will be great.
- The product may have a margin of error of almost $\pm 1^\circ$ even when the inclination is corrected by the level.

Related Topic

- [Switching the screen display \(while shooting/during playback\)](#)

Digital Camera
ZV-1

Checking the camera and the supplied items

The number in parentheses indicates the number of pieces.

- Camera (1)
- NP-BX1 Rechargeable Battery Pack (1)

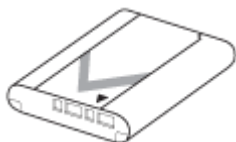

- Micro USB cable (1)

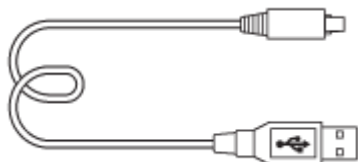

- Wind screen (1) (Attached to the wind screen adaptor)



- Wind screen adaptor (1)
- Shoe Cap (1) (Attached to the camera)
- Startup Guide (1)
- Reference Guide (1)

Inserting/removing the battery pack

- 1 Open the battery/memory card cover by sliding the switch on it.

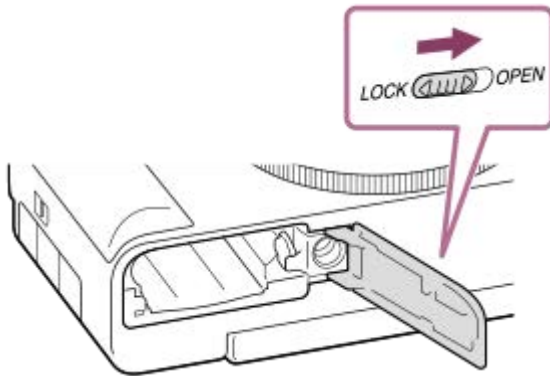

- 2 Insert the battery pack while pressing the lock lever (A) with the tip of the battery until the battery locks into place.

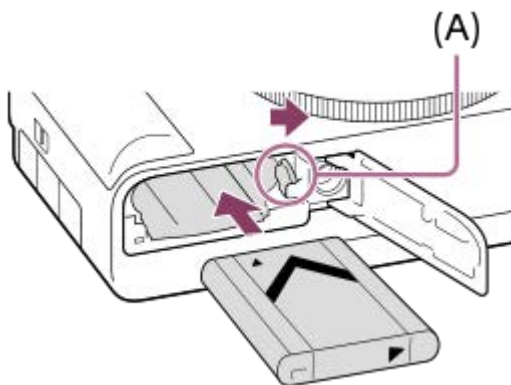

- 3 Close the cover, and then slide the switch towards the LOCK side.

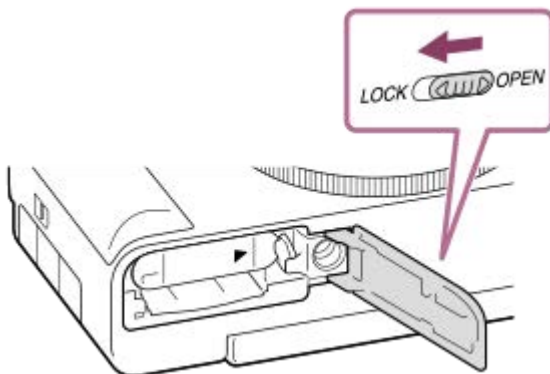

To remove the battery pack

Make sure that the access lamp is not lit, and turn off the camera. Then, slide the lock lever (A) and remove the battery pack. Be careful not to drop the battery pack.

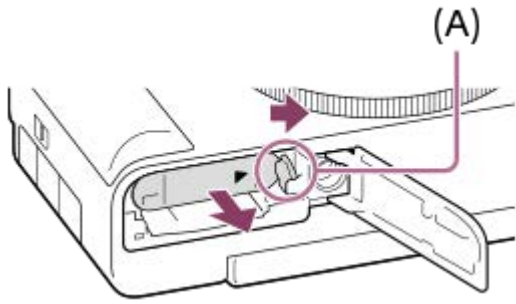

5-016-934-11(1) Copyright 2020 Sony Corporation

Charging the battery pack while it is inserted in the camera

- 1 Turn the power off.
- 2 Make sure that the battery pack is inserted, and connect the camera to a commercially available AC adaptor, etc. using the micro USB cable (supplied). Then, connect the AC adaptor to a wall outlet (wall socket).

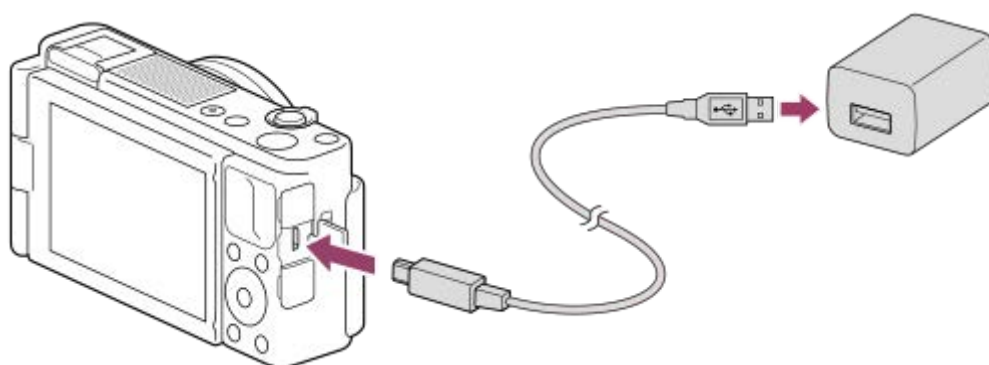

Charge lamp on the camera (orange)

Lit: Charging

Off: Charging finished

Flashing: Charging error or charging paused temporarily because the camera is not within the proper temperature range

- Charging time (Full charge): The charging time is approximately 150 min. (when using an AC adaptor with a rated output of 1.5 A).
- The above charging time applies when charging a fully depleted battery pack at a temperature of 25 °C (77 °F). Charging may take longer depending on conditions of use and circumstances.
- The charge lamp turns off when charging is completed.
- If the charge lamp lights up and then immediately turns off, the battery pack is fully charged.

Note

- When you use an AC adaptor, use one with a rated output of 1.5 A or higher.
- If the charge lamp flashes when the battery pack is not fully charged, remove the battery pack or disconnect the USB cable from the camera and then re-insert it to recharge.
- If the charge lamp on the camera flashes when the AC adaptor, etc. is connected to the wall outlet (wall socket), this indicates that charging is temporarily stopped because the temperature is outside the recommended range. When the temperature gets back within the appropriate range, the charging resumes. We recommend charging the battery pack at an ambient temperature of between 10°C to 30°C (50°F to 86°F).
- Use a nearby wall outlet (wall socket) when using the AC Adaptor/Battery Charger. If any malfunction occurs, disconnect the plug from the wall outlet (wall socket) immediately to disconnect from the power source.
If you use the product with a charge lamp, note that the product is not disconnected from the power source even when the lamp turns off.
- If you turn on the camera, power will be supplied from the wall outlet (wall socket) and you will be able to operate the camera. However, the battery pack will not be charged.
- When you use a completely new battery pack or a battery pack that has not been used for a long time, the charge lamp may flash quickly when the battery is charged. If this happens, remove the battery pack or disconnect the USB cable from the camera and

then re-insert it to recharge.

- Do not continuously or repeatedly charge the battery pack without using it if it is already fully charged or close to fully charged. Doing so may cause a deterioration in battery performance.
- When charging is finished, disconnect the AC adaptor, etc. from the wall outlet (wall socket).
- Be sure to use only genuine Sony brand battery packs and USB cables (supplied).

Related Topic

- [Notes on the battery pack](#)
- [Notes on charging the battery pack](#)
- [Using the battery charger abroad](#)

5-016-934-11(1) Copyright 2020 Sony Corporation

Charging by connecting to a computer

The battery pack can be charged by connecting the camera to a computer using a micro USB cable.

- 1 Turn off the product, and connect to the USB terminal of the computer.

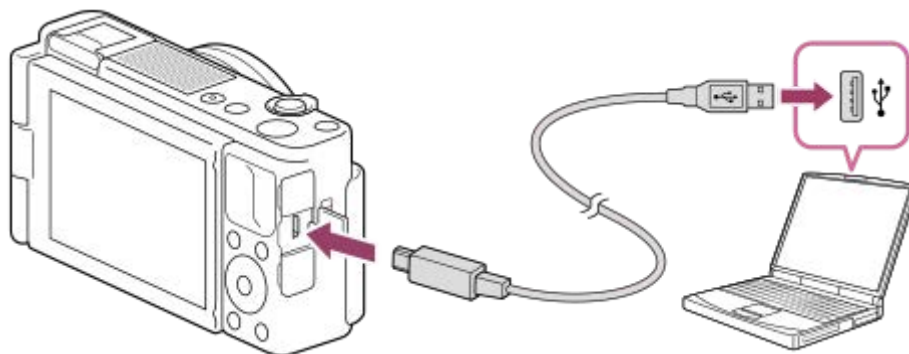

Charge lamp on the camera (orange)

Lit: Charging

Off: Charging finished

Flashing: Charging error or charging paused temporarily because the camera is not within the proper temperature range

- Charging time (Full charge): The charging time is approximately 285 min. (when charging by connecting to a computer).
- The above charging time applies when charging a fully depleted battery pack at a temperature of 25°C (77°F). Charging may take longer depending on conditions of use and circumstances.
- The charge lamp turns off when charging is completed.
- If the charge lamp lights up and then immediately turns off, the battery pack is fully charged.

Note

- If the product is connected to a laptop computer that is not connected to a power source, the laptop battery level decreases. Do not leave the product connected to a laptop computer for an extended period of time.
- Do not turn on/off or restart the computer, or wake the computer from sleep mode when a USB connection has been established between the computer and the camera. Doing so may cause a malfunction. Before turning on/off or restarting the computer, or waking the computer from sleep mode, disconnect the camera from the computer.
- Proper operation cannot be guaranteed on all types of computers.
- Charging cannot be guaranteed with a custom-built computer, modified computer, or a computer connected through a USB hub.
- The camera may not operate correctly when other USB devices are used at the same time.

Related Topic

- [Notes on the battery pack](#)
- [Notes on charging the battery pack](#)



Battery life and number of recordable images

Number of images when shooting still images

When [Auto Monitor OFF] is set to [Does not turn OFF]	Approx. 260 images
When [Auto Monitor OFF] is set to [2 Sec]	Approx. 410 images

Battery life when shooting movies

Actual shooting of movies	Approx. 45 min.
Continuous shooting of movies	Approx. 75 min.

- The above estimates for battery life and number of recordable images apply when the battery pack has been fully charged. The battery life and number of images may decrease depending on the conditions of use.
- The battery life and number of recordable images are estimates based on shooting with the default settings under the following conditions:
 - Using the battery pack at an ambient temperature of 25°C (77°F).
 - Using a Sony SDXC memory card (U3) (sold separately)
- Numbers of images when shooting still images are based on the CIPA standard and shooting under the following conditions:
(CIPA: Camera & Imaging Products Association)
 - One picture is taken every 30 seconds.
 - The power is turned on and off once every ten times.
 - The zoom is switched alternately between the W and T ends.
- The number of minutes for movie shooting is based on the CIPA standard and shooting under the following conditions:
 - The image quality is set to XAVC S HD 60p 50M /50p 50M.
 - Actual shooting (movies): Battery life based on repeated shooting, zooming, shooting stand-by, turning on/off, etc.
 - Continuous shooting (movies): No operations other than starting and ending shooting are performed.

Supplying power from a wall outlet (wall socket)

Use an AC adaptor, etc. to shoot and play back images while power is supplied from a wall outlet (wall socket). This conserves the camera's battery power.

- 1 **Insert the battery pack into the camera.**
- 2 **Connect the camera to the wall outlet (wall socket) with a micro USB cable (supplied) and an AC adaptor, etc.**

Note

- When you use an AC adaptor, use one with a rated output of 1.5 A or higher.
- The camera will not activate if there is no remaining battery. Insert a sufficiently charged battery pack into the camera.
- If you use the camera while power is being supplied from a wall outlet (wall socket), make sure that the icon that shows that powering via USB is in progress () is displayed on the monitor.
- Do not remove the battery pack while power is supplied from a wall outlet (wall socket). If you remove the battery pack, the camera will be turned off.
- Do not remove the battery pack while the access lamp is lit. The data in the memory card may be damaged.
- As long as the power is on, the battery pack will not be charged even if the camera is connected to the AC adaptor, etc.
- Under certain conditions, power may be supplied from the battery pack supplementarily even if you are using the AC adaptor, etc.
- Do not remove the Micro USB cable while power is supplied from a wall outlet (wall socket). Before you remove the Micro USB cable, turn off the camera. The area around the terminal may become hot. Be careful when handling it.
- Depending on the camera and battery temperature, the continuous recording time may be shortened while power is supplied from a wall outlet (wall socket).
- When using a mobile charger as a power source, confirm that it is fully charged before use. Also, be careful of the remaining power on the mobile charger during use.

Notes on the battery pack

Notes on using the battery pack

- Be sure to use only battery packs specified for this product.
- The correct remaining battery indicator may not be displayed under some operating or environmental conditions.
- Do not expose the battery pack to water. The battery pack is not water-resistant.
- Do not leave the battery pack in extremely hot places, such as in a car or under direct sunlight.

Charging the battery pack

- Charge the battery pack (supplied) before using the product for the first time.
- The charged battery pack will discharge little by little even if you do not use it. Charge the battery pack each time before you use the product so that you do not miss any opportunities to shoot images.
- Do not charge battery packs except battery packs specified for this product. Doing so can result in leaks, overheating, explosions, electric shocks, burns, or injuries.
- If the charge lamp flashes when the battery pack is not fully charged, remove the battery pack or disconnect the USB cable from the camera and then reinsert it to recharge.
- We recommend charging the battery pack in an ambient temperature of between 10 °C and 30 °C (50 °F and 86 °F). The battery pack may not be effectively charged in temperatures outside this range.
- When you connect this product and a laptop computer that is not connected to a power source, the laptop's battery charge may decrease. Do not charge this product using the laptop computer for too long.
- Do not turn on/restart a computer, wake a computer from sleep mode, or turn off a computer while this product is connected to the computer via USB cable. Doing so may cause a malfunction of this product. Disconnect the product and the computer before performing the above operations.
- We do not guarantee charging if you are using a self-built or modified computer.
- When charging is finished, disconnect the AC adaptor, etc. from the wall outlet (wall socket) or disconnect the USB cable from the camera. Not doing so may result in a shorter battery life.

Remaining battery indicator

- The remaining battery indicator appears on the screen.



- A:** Battery level high
B: Battery exhausted

- It takes about one minute for the correct remaining battery indicator to appear.
- The correct remaining battery indicator may not be displayed under some operating or environmental conditions.
- If you do not operate the product for a certain period of time while the power is on, the product turns off automatically (Auto power-off function).
- If the remaining battery indicator does not appear on the screen, press the DISP (Display Setting) button to display it.

Charging time (Full charge)

The charging times are as follows.

- When using an AC adaptor with a rated output of 1.5 A: approx. 150 min.
- When charging by connecting to a computer: approx. 285 min.

The above charging time applies when charging a fully depleted battery pack at a temperature of 25 °C (77 °F). Charging may take longer depending on conditions of use and circumstances.

Effective use of the battery pack

- Battery performance decreases in low temperature environments. So in cold places, the operational time of the battery pack is shorter. To ensure longer battery pack use, we recommend putting the battery pack in your pocket close to your body to warm it up, and insert it in the product immediately before you start shooting. If there are any metal objects such as keys in your pocket, be careful of causing a short-circuit.
- The battery pack will run down quickly if you use the flash or continuous shooting function frequently, turn the power on/off frequently, or set the monitor very bright.
- We recommend preparing spare battery packs and taking trial shots before taking the actual shots.
- If the battery terminal is dirty, you may not be able to turn on the product or the battery pack may not be properly charged. In that case, clean the battery by lightly wiping off any dust using a soft cloth or a cotton swab.

How to store the battery pack

To maintain the battery pack's function, charge the battery pack and then fully discharge it in the camera at least once a year before storing it. Store the battery in a cool, dry place after removing it from the camera.

On battery life

- The battery life is limited. If you use the same battery repeatedly, or use the same battery for a long period, the battery capacity decreases gradually. If the available time of the battery is shortened significantly, it is probably time to replace the battery pack with a new one.
- The battery life varies according to how the battery pack is stored and the operating conditions and environment in which each battery pack is used.

Notes on charging the battery pack

- If the product's charge lamp flashes while charging, remove the battery pack being charged, and then insert the same battery pack firmly back into the product. If the charge lamp flashes again, this may indicate a faulty battery or that a battery pack other than the specified type has been inserted. Check that the battery pack is the specified type. If the battery pack is the specified type, remove the battery pack, replace it with a new or different one and check that the newly inserted battery is charging correctly. If the newly inserted battery is charging correctly, the previously inserted battery may be faulty.

Inserting/removing a memory card

Explains how to insert a memory card (sold separately) to the product.

- 1 Open the battery/memory card cover by sliding the switch on it.

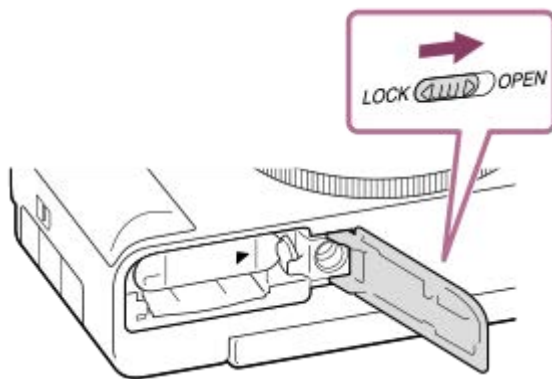

- 2 Insert the memory card.

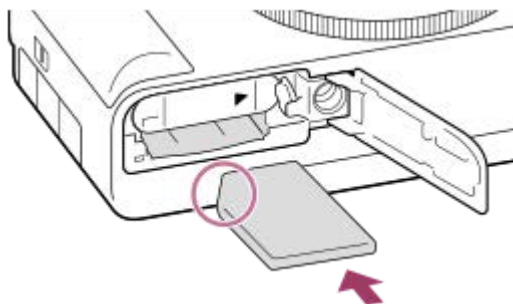

- With the notched corner facing in the direction illustrated, insert the memory card until it clicks into place. Insert the memory card correctly. Not doing so may cause a malfunction.

- 3 Close the cover, and then slide the switch towards the LOCK side.

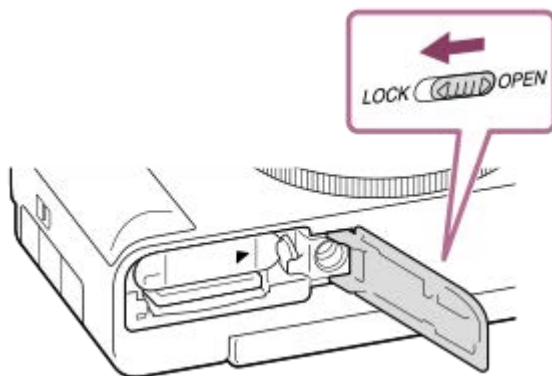

Hint

- When you use a memory card with the camera for the first time, it is recommended that you format the card on the camera for more stable performance of the memory card.

To remove the memory card

Open the memory card cover and make sure that the access lamp **(A)** is not lit, then push in the memory card lightly once to remove it.

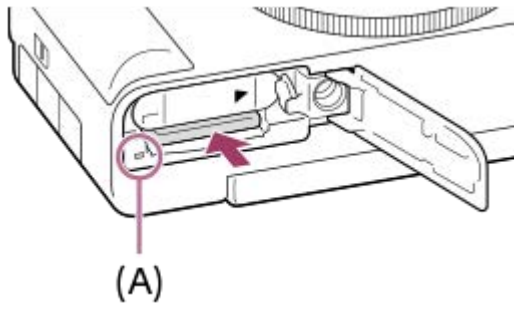

Related Topic

- [Memory cards that can be used](#)
- [Notes on memory card](#)
- [Format](#)

Memory cards that can be used

When using microSD memory cards or Memory Stick Micro media with this camera, be sure to use the appropriate adaptor.

SD memory cards

Recording format	Supported memory card
Still image	SD/SDHC/SDXC card
AVCHD	SD/SDHC/SDXC card (Class 4 or faster, or U1 or faster)
XAVC S 4K 60Mbps* XAVC S HD 50Mbps or lower* XAVC S HD 60Mbps	SDHC/SDXC card (Class 10, or U1 or faster)
XAVC S 4K 100Mbps* XAVC S HD 100Mbps	SDHC/SDXC card (U3)
High Frame Rate*	SDHC/SDXC card (Class 10, or U1 or faster)

* Including when recording proxy movies at the same time

Memory Stick media

Recording format	Supported memory card
Still image	Memory Stick PRO Duo/ Memory Stick PRO-HG Duo
AVCHD	Memory Stick PRO Duo (Mark 2)/ Memory Stick PRO-HG Duo
XAVC S 4K 60Mbps* XAVC S HD 50Mbps or lower* XAVC S HD 60Mbps	Memory Stick PRO-HG Duo
XAVC S 4K 100Mbps* XAVC S HD 100Mbps	—
High Frame Rate*	Memory Stick PRO-HG Duo

* Including when recording proxy movies at the same time

Note

- When an SDHC memory card is used to record an XAVC S movie over extended periods of time, the recorded movies will be divided into files 4 GB in size. The divided files can be handled as a single file by importing them to a computer using PlayMemories Home.
- Charge the battery pack sufficiently before attempting to recover the database files on the memory card.

Related Topic

- [Notes on memory card](#)

- Number of recordable images
- Recordable movie times

5-016-934-11(1) Copyright 2020 Sony Corporation

Notes on memory card

- If you repeatedly shoot and delete images for a long time, fragmentation of data in a file in the memory card may occur, and movie recording may be interrupted in the middle of shooting. If this happens, save your images to a computer or other storage location, then execute [Format] using this camera.
- Do not remove the battery pack or the memory card, disconnect the USB cable, or turn the camera off while the access lamp is lit up. This may cause the data on the memory card to become damaged.
- Be sure to back up the data for protection.
- Not all memory cards are guaranteed to operate correctly.
- Images recorded on an SDXC memory card cannot be imported to or played on computers or AV devices that are not compatible with exFAT when connected using a USB cable. Make sure that the device is compatible with exFAT before connecting it to the camera. If you connect your camera to an incompatible device, you may be prompted to format the card. Never format the card in response to this prompt, as doing so will erase all data on the card. (exFAT is the file system used on SDXC memory cards.)
- Do not expose the memory card to water.
- Do not strike, bend or drop the memory card.
- Do not use or store the memory card under the following conditions:
 - High temperature locations such as in a car parked under the sun
 - Locations exposed to direct sunlight
 - Humid locations or locations with corrosive substances present
- If the memory card is used near areas with strong magnetization, or used in locations subject to static electricity or electrical noise, the data on the memory card may become damaged.
- Do not touch the terminal section of the memory card with your hand or a metal object.
- Do not leave the memory card within the reach of small children. They might accidentally swallow it.
- Do not disassemble or modify the memory card.
- The memory card may be hot just after it has been used for a long time. Be careful when you handle it.
- Memory card formatted with a computer is not guaranteed to operate with the product. Format the memory card using this product.
- Data read/write speeds differ depending on the combination of the memory card and the equipment used.
- Do not press down hard when writing in the memo space on the memory card.
- Do not attach a label on the memory card itself nor on a memory card adaptor.
- If the write-protect switch or delete-protect switch of a memory card is set to the LOCK position, you cannot record or delete images. In this case, set the switch to the record position.
- To use a Memory Stick Micro media or microSD memory card with this product:
 - Be sure to insert the memory card into a dedicated adaptor. If you insert a memory card into the product without a memory card adaptor, you might not be able to remove it from the product.
 - When inserting a memory card into a memory card adaptor, be sure that the memory card is inserted in the correct direction and then insert it as far as it will go. If the card is not inserted properly, it may result in a malfunction.
- About Memory Stick PRO Duo media and Memory Stick PRO-HG Duo media:
 - This Memory Stick is equipped with MagicGate function. MagicGate is copyright protection technology that uses encryption technology.
Data recording/playback that requires MagicGate functions cannot be performed with this product.
 - High-speed data transfer using a parallel interface is supported.

Setting language, date and time

The setting screen for language, date and time is displayed automatically when you turn on this product for the first time, initialize this product or when the internal rechargeable backup battery has discharged.

1 Turn on the camera.

The language setting screen will appear and then setting screen for date and time will appear.

2 Select your language, and then press the center of the control wheel.

3 Check that [Enter] is selected on the screen, then press the center.

4 Select your desired geographic location, and then press the center.

5 Select a setting item using the top/bottom side of the control wheel or by turning the control wheel, then press the center.

6 Set [Daylight Savings], [Date/Time], and [Date Format] using the top/bottom/left/right sides, then press the center.

- Midnight is indicated as 12:00 AM, and noon as 12:00 PM when you set [Date/Time].
- Change the values using the top/bottom when you set [Date/Time].

7 Repeat Steps 5 and 6 to set other items, then select [Enter] and press the center.

On maintaining the date and time

This camera has an internal rechargeable battery for maintaining the date and time and other settings regardless of whether the power is on or off, or whether the battery pack is charged or discharged.

To charge the internal rechargeable backup battery, insert a charged battery pack into the camera, and leave the product for 24 hours or more with the power off.

If the clock resets every time the battery pack is charged, the internal rechargeable backup battery may be worn out. Consult your service facility.

Hint

- To set the date and time or geographic location again after the date and time setting is finished, select MENU →  (Setup) → [Date/Time Setup] or [Area Setting].

Note

- If the date and time setting is canceled halfway, the setting screen for the date and time appears every time you turn on the camera.

Related Topic

- [Date/Time Setup](#)

- Area Setting
- Using the control wheel

5-016-934-11(1) Copyright 2020 Sony Corporation

In-Camera Guide

The [In-Camera Guide] displays descriptions of MENU items, Fn (Function) items, and settings.

- 1 Select the MENU or Fn item for which you want to see a description, and then press the  (Delete) button (A).

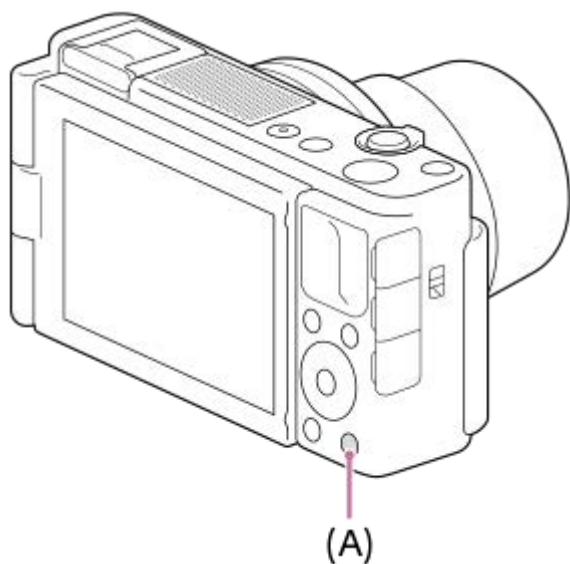

The descriptions of the item are displayed.

Shooting still images

- 1 Select the desired shooting mode by pressing the **MODE (Mode)** button and using the control wheel, and then press the center of the control wheel.

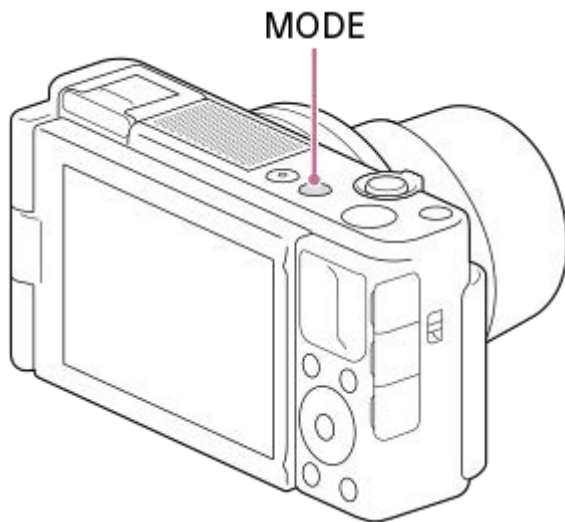

- 2 Adjust the monitor angle, and hold the camera.
- 3 Enlarge images with the **W/T (zoom)** lever when shooting.
- 4 Press the shutter button halfway down to focus.

When the image is in focus, a beep sounds and the indicator (such as ●) lights up.

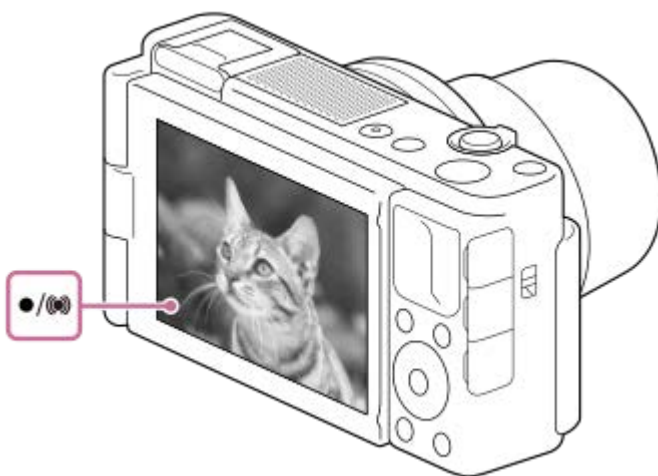

- The shortest shooting distance is approximately 5 cm (0.16 ft.) (W), 30 cm (0.98 ft.) (T) (from the lens).

- 5 Press the shutter button fully down.

To shoot images with the focus locked on the desired subject (**Focus-lock**)

Shoots images with the focus locked on the desired subject in auto focus mode.

1. MENU →  1 (Camera Settings1) → [Focus Mode] → [Single-shot AF] or [Automatic AF].
2. Place the subject within the AF area and press the shutter button halfway down.



The focus is locked.

- If it is difficult to focus on the desired subject, set [Focus Area] to [Center] or [Flexible Spot].
3. Keep pressing the shutter button halfway down, and place the subject back in the original position to re-compose the shot.



4. Press the shutter button down fully to take the picture.

Hint

- When the product cannot focus automatically, the focus indicator flashes and the beep does not sound. Either re-compose the shot or change the focus setting. In the [Continuous AF] mode,  (focus indicator) lights up and the beep indicating successful focusing does not sound.
- An icon indicating that data is being written is displayed after shooting. Do not remove the memory card while the icon is displayed.

Note

- When the subject is moving, you cannot lock the focus even if [Focus Mode] has been set to [Automatic AF].

Related Topic

- [Changing shooting modes \(Shoot Mode\)](#)
- [Playing back still images](#)
- [Auto Review](#)
- [Focus Mode](#)
- [Focus Area](#)

Focus Mode

Selects the focus method to suit the movement of the subject.

1 MENU →  1 (Camera Settings1) → [Focus Mode] → desired setting.

Menu item details

AF-S (Single-shot AF):

The product locks the focus once focusing is complete. Use this when the subject is motionless.

AF-A (Automatic AF):

[Single-shot AF] and [Continuous AF] are switched according to the movement of the subject. When the shutter button is pressed halfway down, the product locks the focus when it determines that the subject is motionless, or continues to focus when the subject is in motion. During continuous shooting, the product automatically shoots with Continuous AF from the second shot.

AF-C (Continuous AF):

The product continues to focus while the shutter button is pressed and held halfway down. Use this when the subject is in motion. In [Continuous AF] mode, there is no beep when the camera focuses.

DMF (DMF):

You can make fine adjustments manually after performing auto focusing, letting you focus on a subject more quickly than when using the manual focus from the beginning. This is convenient in situations such as macro shooting.

MF (Manual Focus):

Adjusts the focus manually. If you cannot focus on the intended subject using auto focus, use manual focus.

Focus indicator

● (lit):

The subject is in focus and the focus is locked.

● (flashing):

The subject is not in focus.

⦿ (lit):

The subject is in focus. The focus will be adjusted continuously according to the movements of the subject.

⦿ (lit):

Focusing is in progress.

Subjects on which it is difficult to focus using auto focus

- Dark and distant subjects
- Subjects with poor contrast
- Subjects seen through glass
- Fast-moving subjects
- Reflective light or shiny surfaces
- Flashing light
- Back-lit subjects
- Continuously repetitive patterns, such as the facades of buildings
- Subjects in the focusing area with different focal distances

Hint

- When you set the focus to infinity in the manual focus mode or the direct manual focus mode, make sure that the focus is on a sufficiently distant subject by checking the monitor.

Note

- Only [Continuous AF] and [Manual Focus] are available when shooting movies or when the shooting mode is set to **HFR** (High Frame Rate).

Related Topic

- [Direct manual focus \(DMF\)](#)
- [Manual Focus \(Set Focus\)](#)
- [MF Assist \(still image\)](#)
- [Phase detection AF](#)

5-016-934-11(1) Copyright 2020 Sony Corporation

Focus Area

Selects the focusing area. Use this function when it is difficult to focus properly in the auto focus mode.

1 MENU →  (Camera Settings1) → [Focus Area] → desired setting.

Menu item details

Wide :

Focuses on a subject covering the whole range of the screen automatically. When you press the shutter button halfway down in the still image shooting mode, a green frame is displayed around the area that is in focus.

Zone :

Select a zone on the monitor on which to focus, and the product will automatically select a focus area.

Center :

Focuses automatically on a subject in the center of the image. Use together with the focus-lock function to create the composition you want.

Flexible Spot :

Allows you to move the focusing frame to a desired point on the screen and focus on an extremely small subject in a narrow area.

On the Flexible Spot shooting screen, you can change the size of the focusing frame by turning the control wheel.

Expand Flexible Spot :

If the product cannot focus on a single selected point, it uses focus points around the flexible spot as a secondary priority area for focusing.







Tracking:

When the shutter button is pressed and held halfway down, the product tracks the subject within the selected autofocus area. This setting is available only when the focus mode is set to [Continuous AF]. Point the cursor at [Tracking] on the [Focus Area] setting screen, and then select the desired area to start tracking using the left/right sides of the control wheel. You can also move the tracking start area to the desired point by designating the area as a zone, flexible spot or expand flexible spot. On the Flexible Spot shooting screen, you can change the size of the focusing frame by turning the control wheel.

To move the focus area

- When [Focus Area] is set to [Zone], [Flexible Spot] or [Expand Flexible Spot], if pressing the button to which [Focus Standard] is assigned, you can shoot while moving the focusing frame using the top/bottom/left/right sides of the control wheel. To return the focusing frame to the center of the monitor, press the  (Delete) button while moving the frame. To change the shooting settings using the control wheel, press the button to which [Focus Standard] is assigned.
- You can move the focusing frame quickly by touching and dragging it on the monitor. Set [Touch Operation] to [On], and set [Func. of Touch Operation] to [Touch Focus] beforehand.

Note

- [Focus Area] is locked to [Wide] in the following situations:
 - [Scene Selection]
 - During Smile Shutter mode
 - The shooting mode is set to  (Movie) or  ( Intelligent Auto), and [Auto Dual Rec] is set to [On].
- The focus area may not light up during continuous shooting or when the shutter button is pressed all the way down at once.
- When the shooting mode is set to  (Movie),  ( Intelligent Auto), or **HFR** (High Frame Rate), or during movie shooting, [Tracking] cannot be selected for [Focus Area].
- When [Subject Detection] for [Face/Eye AF Set.] is set to [Animal], [Tracking] cannot be selected as the [Focus Area].

- You cannot perform functions assigned to the control wheel or the custom button 2 while moving the focusing frame.

Related Topic



- [Touch Operation](#)

5-016-934-11(1) Copyright 2020 Sony Corporation

Phase detection AF

When there are phase detection AF points within the auto focus area, the product uses the combined autofocus of the phase detection AF and contrast AF.



Note

- When the F-value is greater than F8, you cannot use the Phase Detection AF. Only Contrast AF is available.
- When [ File Format] is set to [XAVC S HD] and [ Record Setting] is set to [120p]/[100p], Phase Detection AF cannot be used. Only Contrast AF is available.

Focus Standard

If you assign [Focus Standard] to the desired custom key, you can recall useful functions such as moving the focusing frame quickly, etc., depending on the focus area settings.

1 MENU →  2 (Camera Settings2) → [ Custom Key] → desired key, then assign the [Focus Standard] function to the key.

- To use the [Focus Standard] function while shooting movies, select MENU →  2 (Camera Settings2) → [ Custom Key] → the desired button, and then assign [Focus Standard] to the key.

2 Press the key to which [Focus Standard] is assigned.

- What you can do by pressing the key varies depending on the setting for [Focus Area].

When [Focus Area] is set to [Zone], [Flexible Spot], [Expand Flexible Spot], [Tracking: Zone], [Tracking: Flexible Spot] or [Tracking: Expand Flexible Spot]:

Pressing the key moves the position of the focusing frame using the top/bottom/left/right sides of the control wheel.

Hint

- When [Focus Mode] is set to [Manual Focus] or [DMF], you can display the screen for manual focusing operations by pressing the key to which [Focus Standard] is assigned.

Note

- You cannot set the [Focus Standard] function to [Left Button] or [Right Button].

Related Topic

- [Assigning frequently used functions to buttons \(Custom Key\)](#)
- [Focus Area](#)

Digital Camera
ZV-1

AF/MF control

You can easily switch the focusing mode from auto to manual and vice versa while shooting without changing your holding position.

- 1 MENU →  2 (Camera Settings2) → [ Custom Key] or [ Custom Key] → desired button → [AF/MF Control Hold] or [AF/MF Ctrl Toggle].

Menu item details

AF/MF Control Hold :

Switches the focusing mode while the button is held down.

AF/MF Ctrl Toggle :

Switches the focusing mode until the button is pressed again.

Note

- You cannot set the [AF/MF Control Hold] function to [Left Button] or [Right Button] of the control wheel.



Related Topic

- [Assigning frequently used functions to buttons \(Custom Key\)](#)

Focusing on eyes (Face/Eye AF Set.)

[Face/Eye AF Set.] is used to determine whether or not the camera focuses with priority on faces/eyes.

There are two methods for performing [Eye AF], with some differences between their specifications. Select the appropriate method according to your purpose.

Item	[Eye AF] via [Face/Eye AF Set.]	[Eye AF] via a custom key Details can be found here. →
Subject detection	The camera will detect faces/eyes with greater priority.	The camera will detect faces/eyes exclusively.
Advance preparation	Select [Face/Eye AF Set.] → [Face/Eye Priority in AF] → [On].	Assign [Eye AF] to the desired key using [ Custom Key] or [ Custom Key].
How to perform [Eye AF]	Press the shutter button halfway down.	Press the key to which you have assigned the [Eye AF] function*.
Specifications	<ul style="list-style-type: none"> When the camera detects a face or eye inside or around the designated focus area, it focuses on the face or eye with greater priority. If the camera does not detect any faces or eyes inside or around the designated focus area, it will focus on another detectable subject. 	<ul style="list-style-type: none"> The camera focuses exclusively on faces or eyes anywhere on the screen, regardless of the setting for [Focus Area]. The camera will not automatically focus on another subject if no face or eye is detected anywhere on the screen.
Focus mode	Follows the setting designated with [Focus Mode]	Follows the setting designated with [Focus Mode]
Focus area	Follows the setting designated with [Focus Area]	The focus area temporarily becomes the entire screen, regardless of the setting for [Focus Area].
How the following functions under [Face/Eye AF Set.] work <ul style="list-style-type: none"> Subject Detection Right/Left Eye Select Face/Eye Frame Display Animal Eye Display 	Follows the setting designated with each menu item	Follows the setting designated with each menu item

* Regardless of whether [Face/Eye Priority in AF] under [Face/Eye AF Set.] is set to [On] or [Off], you can use [Eye AF] via a custom key while you are pressing the custom key to which you have assigned [Eye AF].

1 MENU →  1 (Camera Settings1) → [Face/Eye AF Set.] → desired setting item.

Menu item details

Face/Eye Priority in AF :

Sets whether or not to detect faces or eyes inside the focusing area and focus on the eyes (Eye AF) when autofocus is activated. ([On]/[Off])

(Note: The camera operations are different when using the custom key to execute [Eye AF].)

Subject Detection :

Selects the target to be detected.

[Human]: Detects human faces/eyes.

[Animal]: Detects animal eyes. Animal faces are not detected.

Right/Left Eye Select :

Specifies the eye to be detected when [Subject Detection] is set to [Human]. If [Right Eye] or [Left Eye] is selected, only the selected eye is detected. When [Subject Detection] is set to [Animal], [Right/Left Eye Select] cannot be used.

[Auto]: The camera detects eyes automatically.

[Right Eye]: The right eye of the subject (the eye on the left side from the photographer's perspective) is detected.

[Left Eye]: The left eye of the subject (the eye on the right side from the photographer's perspective) is detected.

Face/Eye Frame Display :

Sets whether or not to display the face/eye detection frame when a human face or eyes are detected. ([On]/[Off])

Animal Eye Display :

Sets whether or not to display the eye detection frame when the eye of an animal is detected. ([On]/[Off])

Face detection frame

When the product detects a face, the gray face detection frame appears. When the product determines that autofocus is enabled, the face detection frame turns white.

In case you have registered the priority order for each face using [Face Registration], the product automatically selects the first prioritized face and the face detection frame over that face turns white. The face detection frames of other registered faces turn reddish-purple.



Eye detection frame

A white eye detection frame appears when an eye is detected and the camera determines that autofocusing is possible, depending on the settings.

The eye detection frame is displayed when [Subject Detection] is set to [Animal].



[Eye AF] by custom key

The Eye AF function can also be used by assigning [Eye AF] to a custom key. The camera can focus on eyes as long as you are pressing the key. This is useful when you want to temporarily apply the Eye AF function to the entire screen regardless of the setting for [Focus Area]. The camera does not focus automatically if no faces or eyes are detected. (Note: When you try to focus on eyes by pressing the shutter button halfway down, the camera only detects faces or eyes inside or around the focus area designated with [Focus Area]. If the camera detects no faces or eyes, it performs normal auto-focusing.)

1. MENU → (Camera Settings2) → [Custom Key] or [Custom Key] → desired key, then assign the [Eye AF] function to the key.
2. MENU → (Camera Settings1) → [Face/Eye AF Set.] → [Subject Detection] → desired setting.
3. Point the camera at the face of a human or animal, and press the key to which you have assigned the [Eye AF] function.
To shoot a still image, press the shutter button while pressing the key.

[Switch Right/Left Eye] by custom key

When [Subject Detection] is set to [Human] and [Right/Left Eye Select] is set to [Right Eye] or [Left Eye], you can switch the eye to be detected by pressing the custom key to which you have assigned the [Switch Right/Left Eye] function. When [Right/Left Eye Select] is set to [Auto], you can temporarily switch the eye to be detected by pressing the custom key to which you have assigned the [Switch Right/Left Eye] function.

The temporary left/right selection is cancelled when you perform the following operations, etc. The camera returns to automatic eye detection.

- Pressing the center of the control wheel
- Stopping pressing the shutter button halfway down (only during still image shooting)
- Stopping pressing the custom key to which [Eye AF] is assigned (only during still image shooting)
- Pressing the MENU button

Hint

- When [Right/Left Eye Select] is not set to [Auto], or you execute [Switch Right/Left Eye] using the custom key, the eye detection frame appears. Even when [Right/Left Eye Select] is set to [Auto], if [Face/Eye Frame Display] is set to [On], the eye detection frame will appear over detected eyes during movie shooting.
- If you want the face or eye detection frame to disappear within a certain period of time after the camera has focused on the face or eye, set [AF Area Auto Clear] to [On].

Note

- When [Subject Detection] is set to [Human], the eyes of animals are not detected. When [Subject Detection] is set to [Animal], human faces are not detected.
- When [Scene Selection] is set to [Portrait], [Face/Eye Priority in AF] is locked to [On], and [Subject Detection] is locked to [Human].
- When [Scene Selection] is set to [Pet], [Face/Eye Priority in AF] is locked to [On], and [Subject Detection] is locked to [Animal].
- When [Smile Shutter] is set to [On], [Face/Eye Priority in AF] is locked to [On], and [Subject Detection] is locked to [Human].
- When [Subject Detection] is set to [Animal], the following functions cannot be used.
 - Right/Left Eye Select
 - Tracking function
 - Face Priority in Multi Metering
 - Regist. Faces Priority
 - Soft Skin Effect
- The [Eye AF] function may not function very well in the following situations:

- When the person is wearing sunglasses.
 - When the front hair covers the person's eyes.
 - In low-light or back-lit conditions.
 - When the eyes are closed.
 - When the subject is in the shade.
 - When the subject is out of focus.
 - When the subject is moving too much.
- If the subject is moving too much, the detection frame may not be displayed correctly over their eyes.
 - Depending on the circumstances, the eyes cannot be focused.
 - When the camera cannot focus on human eyes, it will detect and focus on the face instead. The camera cannot focus on eyes when no human faces are detected.
 - The product may not detect faces at all or may accidentally detect other objects as faces in some conditions.
 - When recording movies with [Subject Detection] set to [Animal], you cannot use the eye detection function.
 - When shooting movies, eyes at the right and left edges of the screen cannot be detected.
 - The eye detection frame is not displayed when the Eye AF function is unavailable.
 - You cannot use the face/eye detection function with the following functions:
 - Zoom functions other than the optical zoom.
 - [Sweep Panorama]
 - [Posterization] under [Picture Effect]
 - Focus Magnifier
 - When [Scene Selection] is set to [Landscape], [Night Scene], or [Sunset]
 - Movie shooting with [Record Setting] set to [120p]/[100p]
 - When shooting with a high frame rate.
 - When [File Format] is set to [XAVC S 4K], [Record Setting] is set to [30p 100M]/[25p 100M] or [30p 60M]/[25p 60M], and [4K Output Select] is set to [Memory Card+HDMI]
 - When [File Format] is set to [XAVC S 4K] and [Proxy Recording] is set to [On]
 - Up to 8 faces of your subjects can be detected.
 - Even if [Face/Eye Frame Display] or [Animal Eye Display] is set to [Off], a green focusing frame will be displayed over faces or eyes that are in focus.
 - To detect animal eyes, arrange the composition so that both eyes and the nose of the animal are within the angle of view. Once you focus on the animal's face, the animal's eyes will be detected more easily.
 - Even when [Subject Detection] is set to [Animal], the eyes of some types of animals cannot be detected.

Related Topic

- [Focus Mode](#)
- [Focus Area](#)
- [AF Area Auto Clear](#)
- [Assigning frequently used functions to buttons \(Custom Key\)](#)

Tracking subject (Tracking function)

This camera has the function of tracking which tracks the subject, and keeps marking it with the focusing frame. You can set the start position to track by selecting from focusing areas, or by specifying by touch operation. The required function varies depending on the setting method.

- For the examples of usage, etc. of tracking function, refer to the following URL.
For still image shooting:
https://support.d-imaging.sony.co.jp/support/tutorial/dc/zv-1/still_tracking.php
For movie shooting:
https://support.d-imaging.sony.co.jp/support/tutorial/dc/zv-1/movie_tracking.php
- You can refer to the related functions under “Related Topic” at the bottom of this page.

Setting the start position to track by focusing area ([Tracking] under [Focus Area])

The selected focusing frame is set as the start position to track, and the tracking starts by pressing the shutter button halfway down.

- This function is available in still image shooting mode.
- This function is available when [Focus Mode] is set to [Continuous AF].

Setting the start position to track by touch operation ([Touch Tracking] under [Func. of Touch Operation])

You can set the subject to track by touching it on the monitor.

- This function is available in still image shooting mode and movie shooting mode.
- This function is available when [Focus Mode] is set to [Single-shot AF], [Automatic AF] or [Continuous AF].

Related Topic

- [Focus Mode](#)
- [Focus Area](#)
- [Func. of Touch Operation: Touch Tracking](#)
- [Assigning frequently used functions to buttons \(Custom Key\)](#)

Digital Camera
ZV-1

Focus Frame Color

You can specify the color of the frame indicating the focusing area. If the frame is difficult to see because of the subject, make it more visible by changing its color.

1 MENU →  1 (Camera Settings1) → [Focus Frame Color] → desired color.

Menu item details

White:

Displays the frame indicating the focusing area in white.

Red:

Displays the frame indicating the focusing area in red.

Digital Camera
ZV-1

Pre-AF (still image)

The product automatically adjusts focus before you press the shutter button halfway down. During focusing operations, the screen may shake.

1 MENU →  1 (Camera Settings1) → [ Pre-AF] → **desired setting.**

Menu item details

On:

Adjusts focus before you press the shutter button halfway down.

Off:

Does not adjust focus before you press the shutter button halfway down.

Digital Camera
ZV-1

AF Area Auto Clear

Sets whether the focus area should be displayed all the time or should disappear automatically shortly after focus is achieved.

1 MENU →  1 (Camera Settings1) → [AF Area Auto Clear] → desired setting.

Menu item details

On:

The focus area disappears automatically shortly after focus is achieved.

Off:

The focus area is displayed all the time.

Digital Camera
ZV-1

Disp. cont. AF area

You can set whether or not to display the area that is in focus when [Focus Area] is set to [Wide] or [Zone], in [Continuous AF] mode.

1 MENU →  1 (Camera Settings1) → [Disp. cont. AF area] → desired setting.

Menu item details

On:

Displays the focus area that is in focus.

Off:

Does not display the focus area that is in focus.

Note

- When [Focus Area] is set to one of the following, the focusing frames in the area that is in focus turn green:
 - [Center]
 - [Flexible Spot]
 - [Expand Flexible Spot]

Digital Camera
ZV-1

Phase Detect. Area

Sets whether or not to display the Phase Detection AF area.

1 MENU →  1 (Camera Settings1) → [Phase Detect. Area] → desired setting.

Menu item details



On:

Displays the Phase Detection AF area.

Off:

Does not display the Phase Detection AF area.

Note

- When the F-value is larger than F8, Phase Detection AF cannot be used. Only Contrast AF is available.
- When [ File Format] is set to [XAVC S HD] and [ Record Setting] is set to [120p]/[100p], Phase Detection AF cannot be used. Only Contrast AF is available.
- When recording movies, the Phase Detection AF area will not be displayed.

Digital Camera
ZV-1

Circ. of Focus Point

Sets whether to allow the focusing frame to jump from one end to the other when you move the focusing frame with [Focus Area] set to [Zone], [Flexible Spot], [Expand Flexible Spot], [Tracking: Zone], [Tracking: Flexible Spot] or [Tracking: Expand Flexible Spot]. This function is useful when you want to move the focusing frame from one end to the other quickly.

1 MENU →  (Camera Settings1) → [Circ. of Focus Point] → desired setting.

When [Circulate] is selected:

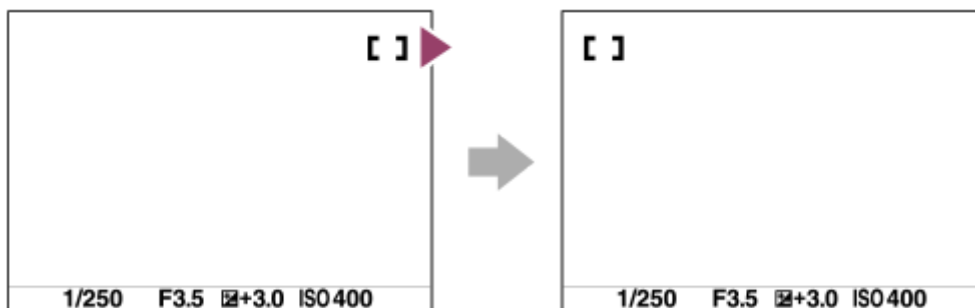

Menu item details

Does Not Circulate :

The cursor does not move when you try to move the focusing frame past the end.

Circulate :

The cursor jumps to the opposite end when you try to move the focusing frame past the end.

Related Topic

- [Focus Area](#)



Manual Focus (Set Focus)

If it is difficult to focus properly in the autofocus mode, you can adjust the focus manually.

1 MENU →  (Camera Settings1) → [Focus Mode] → [Manual Focus].

2 MENU →  (Camera Settings1) → [Set Focus].

The screen for manual focusing operations will appear.

- The screen for manual focusing operations can also be displayed by pressing the key to which [Focus Standard] has been assigned using [ Custom Key] or [ Custom Key].

3 Press the left/right side of the control wheel or turn the control wheel to adjust the focus.

- The focus distance will be displayed on the screen.
- To enable fine adjustments to the focus under various conditions, the focusing indicator can be moved beyond infinity. When you want to focus at infinity, do not move the indicator to the end of the bar. Instead, adjust the focus while checking the monitor, etc.
- To return to the shooting screen, press the center of the control wheel.

4 Press the shutter button all the way down to shoot.

Hint

- Using [ MF Assist] allows you to manually focus more easily because the image is automatically enlarged during manual focus adjustments. While the magnified image is displayed, you can use the top/bottom/left/right side of the control wheel to adjust which part of the image to magnify. Turn the control wheel to adjust the focus. You can also change the magnification scale by pressing the center of the control wheel.
- When you use [Peaking Setting], the outlines of in-focus ranges are enhanced using a specific color. This function allows you to check the focus easily.

Note

- Manually set focus distances are cancelled when [Focus Mode] is reselected.
- The displayed focus distance is just a reference.

Related Topic

- [MF Assist \(still image\)](#)
- [Peaking Setting](#)

Direct manual focus (DMF)



You can make fine adjustments manually after performing auto focusing, letting you focus on a subject more quickly than when using the manual focus from the beginning. This is convenient in situations such as macro shooting.

1 MENU →  (Camera Settings1) → [Focus Mode] → [DMF].

2 Press the shutter button halfway down to focus automatically.

3 MENU →  (Camera Settings1) → [Set Focus].

The screen for manual focusing operations will appear.

- The screen for manual focusing operations can also be displayed by pressing the key to which [Focus Standard] has been assigned using [ Custom Key] or [ Custom Key].

4 Press the left/right side of the control wheel or turn the control wheel to adjust the focus.

- The focus distance will be displayed on the screen.
- To enable fine adjustments to the focus under various conditions, the focusing indicator can be moved beyond infinity. When you want to focus at infinity, do not move the indicator to the end of the bar. Instead, adjust the focus while checking the monitor, etc.
- To return to the shooting screen, press the center of the control wheel.

5 Press the shutter button fully down to shoot an image.

Hint

- Using [ MF Assist] allows you to manually focus more easily because the image is automatically enlarged during manual focus adjustments. While the magnified image is displayed, you can use the top/bottom/left/right side of the control wheel to adjust which part of the image to magnify. Turn the control wheel to adjust the focus. You can also change the magnification scale by pressing the center of the control wheel.





Related Topic

- [MF Assist \(still image\)](#)

Focus Magnifier

You can check the focus by enlarging the image before shooting.

Unlike with [ MF Assist], you can magnify the image without needing to perform manual focusing operations.

- 1 MENU →  (Camera Settings1) → [Focus Magnifier].**
- 2 Press the center of the control wheel to enlarge the image and select the area you want to enlarge using top/bottom/left/right side of the control wheel.**
 - When you press the center of the control wheel, the magnification scale changes.
 - You can set the initial magnification by selecting MENU →  (Camera Settings1) → [ Initial Focus Mag.].
- 3 Confirm the focus.**
 - Press the  (Delete) button to bring the magnified position into the center of an image.
 - When the focus mode is [Manual Focus], you can adjust the focus while an image is magnified. The [Focus Magnifier] function will be canceled when the shutter button is pressed halfway.
 - You can set how long the image is to be shown magnified by selecting MENU →  (Camera Settings1) → [Focus Magnif. Time].
- 4 Press the shutter button fully down to shoot the image.**

To use the focus magnifier function by touch operation

You can magnify the image and adjust the focus by touching the monitor. Set [Touch Operation] to [On] beforehand. When the focus mode is [Manual Focus], you can perform [Focus Magnifier] by double-tapping the area to focus on.

Hint

- While using the focus magnifier function, you can move the magnified area by dragging it on the touch panel.
- To exit the focus magnifier function, double-tap the monitor again. You can also exit the focus magnifier function by pressing the shutter button halfway down.

Related Topic

- [MF Assist \(still image\)](#)
- [Focus Magnif. Time](#)
- [Initial Focus Mag. \(still image\)](#)
- [Touch Operation](#)

Digital Camera
ZV-1

MF Assist (still image)

Enlarges the image on the screen automatically to make manual focusing easier. This works in Manual Focus or Direct Manual Focus shooting.

1 MENU →  1 (Camera Settings1) → [ MF Assist] → [On].

2 MENU →  1 (Camera Settings1) → [Set Focus].

- The image is enlarged. You can magnify images further by pressing the center of the control wheel.

Hint

- You can set how long the image is to be shown magnified by selecting MENU →  1 (Camera Settings1) → [Focus Magnif. Time].

Note

- You cannot use [ MF Assist] when shooting movies. Use the [Focus Magnifier] function instead.

Related Topic

- [Manual Focus \(Set Focus\)](#)
- [Direct manual focus \(DMF\)](#)
- [Focus Magnif. Time](#)

Digital Camera
ZV-1

Focus Magnif. Time

Set the duration for which an image is to be magnified using the [ MF Assist] or [Focus Magnifier] function.

1 MENU →  1 (Camera Settings1) → [Focus Magnif. Time] → desired setting.

Menu item details

2 Sec:

Magnifies the images for 2 seconds.

5 Sec:

Magnifies the images for 5 seconds.

No Limit:

Magnifies the images until you press the shutter button.



Related Topic

- [Focus Magnifier](#)
- [MF Assist \(still image\)](#)

Digital Camera
ZV-1

Initial Focus Mag. (still image)

Sets the initial magnification scale when using [Focus Magnifier]. Select a setting that will help you frame your shot.

1 MENU →  1 (Camera Settings1) → [ Initial Focus Mag.] → desired setting.

Menu item details

x1.0:

Displays the image with the same magnification as the shooting screen.

x5.3:

Displays a 5.3-times enlarged image.

Related Topic

- [Focus Magnifier](#)

Peaking Setting

Sets the peaking function, which enhances the outline of in-focus areas during shooting with Manual Focus or Direct Manual Focus.

1 MENU →  1 (Camera Settings1) → [Peaking Setting] → desired setting.

Menu item details

Peaking Display:

Sets whether to display peaking.

Peaking Level:

Sets the level of enhancement of in-focus areas.

Peaking Color:

Sets the color used to enhance in-focus areas.

Note



- Since the product recognizes sharp areas as in focus, the effect of peaking differs, depending on the subject.
- The outline of in-focus ranges is not enhanced on devices connected via HDMI.

Related Topic

- [Manual Focus \(Set Focus\)](#)
- [Direct manual focus \(DMF\)](#)

Drive Mode

Select the appropriate mode for the subject, such as single shooting, continuous shooting or bracketing shooting.

- 1 Select  (Drive Mode) on the control wheel → desired setting.
 - You can also set the drive mode by selecting MENU →  1 (Camera Settings1) → [Drive Mode].
- 2 Select the desired mode using the right/left side of the control wheel.

Menu item details

Single Shooting :

Normal shooting mode.

Cont. Shooting :

Shoots images continuously while you press and hold down the shutter button.

Self-timer :

Shoots an image using the self-timer after a designated number of seconds have elapsed since the shutter button was pressed.

Self-timer(Cont) :

Shoots a designated number of images using the self-timer after a designated number of seconds have elapsed since the shutter button was pressed.

Cont. Bracket :

Shoots images while holding the shutter button down, each with different degrees of exposure.

Single Bracket :

Shoots a specified number of images, one by one, each with a different degrees of exposure.

WB bracket :

Shoots a total of three images, each with different color tones according to the selected settings for white balance, color temperature and color filter.

DRO Bracket :

Shoots a total of three images, each at a different degree of D-Range Optimizer.

Note



- When the shooting mode is set to [Scene Selection] and [Sports Action] is selected, [Single Shooting] cannot be performed.

Related Topic



- [Cont. Shooting](#)
- [Self-timer](#)
- [Self-timer\(Cont\)](#)
- [Cont. Bracket](#)
- [Single Bracket](#)
- [WB bracket](#)
- [DRO Bracket](#)



Cont. Shooting

Shoots images continuously while you press and hold down the shutter button.

- 1 Select  (Drive Mode) of the control wheel → [Cont. Shooting].
 - You can also set the continuous shooting by selecting MENU →  1 (Camera Settings1) → [Drive Mode].
- 2 Select the desired mode using the right/left side of the control wheel.

Menu item details

 Continuous Shooting: Hi /  Continuous Shooting: Mid /  Continuous Shooting: Lo

Type of continuous shooting	 Shutter Type: Mechanical Shutter	 Shutter Type: Auto/Electronic Shutter
Continuous Shooting: Hi	–	24 images per second at maximum [*]
Continuous Shooting: Mid	10 images per second at maximum [*]	10 images per second at maximum [*]
Continuous Shooting: Lo	3 images per second at maximum	3 images per second at maximum

* When the F-value is greater than F8, the focus is locked to the setting in the first shot.

Hint

- To continuously adjust the focus and exposure during continuous shooting, set as follows:
 - [Focus Mode]: [Continuous AF]

Note

- Continuous shooting is unavailable in the following situations:
 - The shooting mode is set to [Sweep Panorama].
 - The shooting mode is set to [Scene Selection] and a scene other than [Sports Action] is selected.
 - [Picture Effect] is set to one of the following: [Soft Focus] [HDR Painting] [Rich-tone Mono.] [Miniature] [Watercolor] [Illustration]
 - [DRO/Auto HDR] is set to [Auto HDR].
 - [ISO] is set to [Multi Frame NR].
 - [Smile Shutter] is being used.
- When [ Shutter Type] is set to [Mechanical Shutter], the continuous shooting speed cannot be set to [Continuous Shooting: Hi].
- The speed of continuous shooting decreases when you shoot with a flash.

Related Topic

- [Focus Mode](#)
- [Shutter Type \(still image\)](#)

Self-timer

Shoots an image using the self-timer after a designated number of seconds have elapsed since the shutter button was pressed. Use the 5-second/10-second self-timer when you are going to be in the picture, and use the 2-second self-timer to reduce camera-shake caused by pressing the shutter button.

1 Press  /  (Drive Mode) of the control wheel → [Self-timer].

- You can also set the drive mode by selecting MENU →  1 (Camera Settings1) → [Drive Mode].

2 Select the desired mode using the right/left side of the control wheel.

3 Adjust the focus and shoot the image.

The self-timer lamp flashes, a beep sounds, and a picture is taken after the designated number of seconds have elapsed.

Menu item details



The mode determines the number of seconds until a picture is taken after the shutter button is pressed.

 **Self-timer: 10 Sec**

 **Self-timer: 5 Sec**

 **Self-timer: 2 Sec**

Hint

- Press the shutter button again or press  /  (Drive Mode) on the control wheel to stop the count of the self-timer.
- Set [Audio signals] to [Off] to turn off the beeping sound during the self-timer countdown.
- To use the self-timer in bracket mode, select bracket mode under drive mode, then select MENU →  1 (Camera Settings1) → [Bracket Settings] → [Selftimer during Bracket].

Note

- The self-timer is unavailable in the following situations:
 - The shooting mode is set to [Sweep Panorama].
 - [Sports Action] under [Scene Selection]
 - [Smile Shutter]

Related Topic

- [Audio signals](#)

Self-timer(Cont)

Shoots a designated number of images using the self-timer after a designated number of seconds have elapsed since the shutter button was pressed. You can choose the best from multiple shots.

1 Press  /  (Drive Mode) of the control wheel → [Self-timer(Cont)].

- You can also set the drive mode by selecting MENU →  1 (Camera Settings1) → [Drive Mode].

2 Select the desired mode using the right/left side of the control wheel.

3 Adjust the focus and shoot the image.

The self-timer lamp flashes, a beep sounds, and pictures are taken after the designated number of seconds has elapsed. The designated number of pictures are taken continuously.

Menu item details

For example, three images are shot when 10 seconds have elapsed after the shutter button is pressed when [Self-timer(Cont.): 10 Sec. 3 Img.] is selected.

 ³/_{10s} Self-timer(Cont.): 10 Sec. 3 Img.

 ⁵/_{10s} Self-timer(Cont.): 10 Sec. 5 Img.





 ³/_{5s} Self-timer(Cont.): 5 Sec. 3 Img.

 ⁵/_{5s} Self-timer(Cont.): 5 Sec. 5 Img.

 ³/_{2s} Self-timer(Cont.): 2 Sec. 3 Img.



 ⁵/_{2s} Self-timer(Cont.): 2 Sec. 5 Img.

Hint

- Press the shutter button again or press  /  (Drive Mode) on the control wheel to stop the count of the self-timer.
- Press  /  (Drive Mode) on the control wheel and select  (Single Shooting) to cancel the self-timer.

Cont. Bracket

Shoots multiple images while automatically shifting the exposure from base to darker and then to lighter. You can select an image that suits your purpose after recording.

- 1 Press  /  (Drive Mode) of the control wheel → [Cont. Bracket].**
 - You can also set the drive mode by selecting MENU →  1 (Camera Settings1) → [Drive Mode].
- 2 Select the desired mode using the right/left side of the control wheel.**
- 3 Adjust the focus and shoot the image.**
 - The base exposure is set at the first shot.
 - Keep pressing and holding the shutter button until bracket shooting is finished.

Menu item details

For example, the camera shoots a total of three images continuously with an exposure value shifted by plus or minus 0.3 EV when [Cont. Bracket: 0.3EV 3 Image] is selected.

Note

- The last shot is shown on the auto review.
- When [ISO AUTO] is selected in [Manual Exposure] mode, the exposure is changed by adjusting the ISO value. If a setting other than [ISO AUTO] is selected, the exposure is changed by adjusting the shutter speed.
- When the exposure is compensated, the exposure is shifted based on the compensated value.
- Bracket shooting is unavailable in the following shooting modes:
 - [Intelligent Auto]
 - [Scene Selection]
 - [Sweep Panorama]
- When the flash is used, the product performs flash bracket shooting, which shifts the amount of flash light even if [Cont. Bracket] is selected. Press the shutter button for each image.



Related Topic

- [Bracket Settings](#)
- [Indicator during bracket shooting](#)

Single Bracket

Shoots multiple images while automatically shifting the exposure from base to darker and then to lighter. You can select the image that suits your purpose after recording.

Since a single picture is taken each time you press the shutter button, you can adjust the focus or the composition for each shot.

- 1 Select  /  (Drive Mode) of the control wheel → [Single Bracket].**
 - You can also set the drive mode by selecting MENU →  1 (Camera Settings1) → [Drive Mode].
- 2 Select the desired mode using the right/left side of the control wheel.**
- 3 Adjust the focus and shoot the image.**
 - Press the shutter button for each image.

Menu item details

For example, when [Single Bracket: 0.3EV 3 Image] is selected, three images are shot one at a time with the exposure value shifted up and down in increments of 0.3 EV.

Note

- When [ISO AUTO] is selected in [Manual Exposure] mode, the exposure is changed by adjusting the ISO value. If a setting other than [ISO AUTO] is selected, the exposure is changed by adjusting the shutter speed.
- When the exposure is compensated, the exposure is shifted based on the compensated value.
- Bracket shooting is unavailable in the following shooting modes:
 - [Intelligent Auto]
 - [Scene Selection]
 - [Sweep Panorama]

Related Topic

- [Bracket Settings](#)
- [Indicator during bracket shooting](#)

Digital Camera
ZV-1

Indicator during bracket shooting

On the [Display All Info.] or [Histogram] screen, you can use the bracket indicator to confirm the bracket shooting settings.

Ambient light* bracketing

3 images shifted by 0.3 EV steps

Exposure compensation ± 0.0 EV



Flash bracketing

3 images shifted by 0.7 EV steps

Flash compensation -1.0 EV

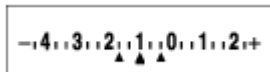

* Ambient light: A generic term for non-flash light including natural light, electric bulb and fluorescent lighting. Whereas the flash light blinks for a moment, ambient light is constant, so this kind of light is called "ambient light."



Note

- During bracket shooting, guides equal to the number of images to be shot are displayed over/under the bracket indicator.
- When you start single bracket shooting, the guides will disappear one by one as the camera records images.

Digital Camera
ZV-1

WB bracket

Shoots a total of three images, each with different color tones according to the selected settings for white balance, color temperature and color filter.

- 1 Select  /  (Drive Mode) of the control wheel → [WB bracket].
 - You can also set the drive mode by selecting MENU →  1 (Camera Settings1) → [Drive Mode].
- 2 Select the desired mode using the right/left side of the control wheel.
- 3 Adjust the focus and shoot the image.

Menu item details

White Balance Bracket: Lo:

Records a series of three images with small changes in the white balance (within the range of 10MK^{-1*}).

White Balance Bracket: Hi:

Records a series of three images with large changes in the white balance (within the range of 20MK^{-1*}).

* MK⁻¹ is the unit that indicates the capability of color temperature conversion filters and indicates the same value as "mired."

Note



- The last shot is shown on the auto review.

Related Topic

- [Bracket Settings](#)

DRO Bracket

You can record a total of three images, each at a different degree of D-Range Optimizer value.

- 1 Select  (Drive Mode) of the control wheel → [DRO Bracket].
 - You can also set the drive mode by selecting MENU→ 1 (Camera Settings1) → [Drive Mode].
- 2 Select the desired mode using the right/left side of the control wheel.
- 3 Adjust the focus and shoot the image.

Menu item details

DRO Bracket: Lo:

Records a series of three images with small changes in the D-Range Optimizer value (Lv 1, Lv 2, and Lv 3).

DRO Bracket: Hi:

Records a series of three images with large changes in the D-Range Optimizer value (Lv 1, Lv 3, and Lv 5).

Note





- The last shot is shown on the auto review.

Related Topic

- [Bracket Settings](#)

Bracket Settings

You can set the self-timer in bracket shooting mode, and the shooting order for exposure bracketing and white balance bracketing.

- 1 Select  /  (Drive Mode) of the control wheel → select bracket shooting mode.
 - You can also set the drive mode by selecting MENU →  1 (Camera Settings1) → [Drive Mode].
- 2 MENU →  1 (Camera Settings1) → [Bracket Settings] → desired setting.

Menu item details

Selftimer during Bracket:

Sets whether to use the self-timer during bracket shooting. Also sets the number of seconds until the shutter is released if using the self-timer.

(OFF/2 Sec/5 Sec/10 Sec)

Bracket order:

Sets the order of exposure bracketing and white balance bracketing.

(0→-→+/-→0→+)

Related Topic

- [Cont. Bracket](#)
- [Single Bracket](#)
- [WB bracket](#)
- [DRO Bracket](#)

Self-portrait/ -timer

You can change the angle of the monitor and shoot images while watching the monitor.

- 1 **MENU** →  1 (Camera Settings1) → [Self-portrait/ -timer] → [On].
- 2 **Open the monitor transversely, face it forward, and then point the lens at yourself.**

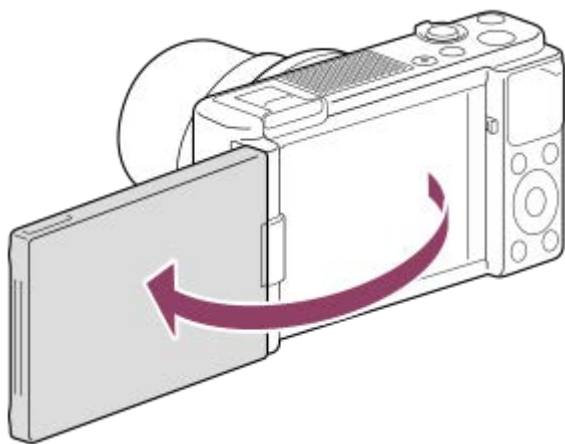

- 3 **Press the shutter button. Alternatively, touch the subject on the monitor.**

A picture is taken after 3 seconds using the self-timer function.

Hint





- If you want to use a drive mode other than the 3-second self-timer mode, first set [Self-portrait/ -timer] to [Off], and then face the monitor forward.

Interval Shoot Func.

You can automatically shoot a series of still images with the shooting interval and number of shots that you set in advance (Interval shooting). You can then create a movie from the still images produced by interval shooting using the computer software Imaging Edge (Viewer). You cannot create a movie from the still images on the camera.

For details on interval shooting, refer to the following URL:

<https://support.d-imaging.sony.co.jp/support/tutorial/dc/zv-1/interval.php>

- 1 **MENU** →  1 (Camera Settings1) → [ Interval Shoot Func.] → [Interval Shooting] → [On].
- 2 **MENU** →  1 (Camera Settings1) → [ Interval Shoot Func.] → Select the item you want to set and the desired setting.
- 3 **Press the shutter button.**
When the time set for [Shooting Start Time] has elapsed, shooting will start.
 - When the number of shots set for [Number of Shots] is completed, the camera will return to the standby screen for interval shooting.

Menu item details

Interval Shooting:

Sets whether to perform interval shooting. ([On]/[Off])

Shooting Start Time:

Sets the time from when you press the shutter button to when interval shooting starts. (1 second to 99 minutes 59 seconds)

Shooting Interval:

Sets the shooting interval (time from when one exposure starts to when the exposure for the next shot starts). (1 second to 60 seconds)

Number of Shots:

Sets the number of shots for interval shooting. (1 shot to 9999 shots)

AE Tracking Sensitivity:

Sets the tracking sensitivity of the auto exposure against the change in luminance during interval shooting. If you select [Low], exposure changes during interval shooting will be smoother. ([High]/[Mid]/[Low])



Shutter Type in Interval:

Sets the shutter type during interval shooting. ([Mechanical Shutter]/[Electronic Shutter])

Shoot Interval Priority:

Sets whether or not to prioritize the shooting interval when the exposure mode is [Program Auto] or [Aperture Priority] and the shutter speed becomes longer than the time set for [Shooting Interval]. ([On]/[Off])

Hint

- If you press the shutter button during interval shooting, interval shooting will end and the camera will return to the standby screen for interval shooting.
- To go back to the normal shooting mode, select MENU →  1 (Camera Settings1) → [ Interval Shoot Func.] → [Interval Shooting] → [Off].
- If you press a key to which one of the following functions has been assigned at the moment when shooting starts, the function will remain active during interval shooting even without you holding down the button.

- [AEL hold]
- [ AEL hold]
- [AF/MF Control Hold]

- If you set [Display as Group] to [On], still images shot with the interval shooting function will be displayed in groups.
- Still images shot with interval shooting can be played back continuously on the camera. If you intend to create a movie using the still images, you can preview the result.

Note

- You may not be able to record the set number of images depending on the remaining battery level and the amount of free space on the recording medium. Supply power via USB while shooting, and use a memory card with sufficient space.
- When the shooting interval is short, the camera may get hot easily. Depending on the ambient temperature, you may not be able to record the set number of images because the camera may stop recording to protect the equipment.
- During interval shooting (including the time between pressing the shutter button and the start of shooting), you cannot operate the dedicated shooting setting screen or MENU screen. However, you can adjust some settings assigned to the control wheel, such as the shutter speed.
- During interval shooting, auto review is not displayed.
- [Shutter Type in Interval] is set to [Electronic Shutter] as a default, regardless of the setting for [ Shutter Type].
- Interval shooting is unavailable in the following situations:
 - The shooting mode is set to other than P/A/S/M
- Selectable shutter speeds may differ depending on the setting for [Shutter Type in Interval].

Related Topic

- [Introduction to computer software \(PlayMemories Home/Imaging Edge\)](#)
- [Cont. PB for Interval](#)
- [Supplying power from a wall outlet \(wall socket\)](#)

Digital Camera
ZV-1

Touch Operation

Sets whether or not to activate touch operations on the monitor.

1 MENU →  (Setup) → [Touch Operation] → **desired setting.**

Menu item details

On:

Activates the touch operation.

Off:

Deactivates the touch operation.



Related Topic

- [Func. of Touch Operation: Touch Shutter](#)
- [Func. of Touch Operation: Touch Focus](#)
- [Func. of Touch Operation: Touch Tracking](#)

Func. of Touch Operation: Touch Shutter

The camera automatically focuses on the point you touch and shoots a still image.

Set MENU →  (Setup) → [Touch Operation] to [On] in advance.

- 1 Select MENU →  2 (Camera Settings2) → [Func. of Touch Operation] → [Touch Shutter].
- 2 Touch the  icon inside the rectangle in the top right of the monitor while the shooting screen is displayed.

The mark to the left of the icon turns orange, and the touch shutter function is activated.

- To cancel [Touch Shutter], touch the  icon again.
- The touch shutter function is canceled when the camera is restarted.

- 3 Touch the subject to focus on.

The camera focuses on the subject you touched, and a still image is recorded.

Hint

- You can operate the shooting functions below by touching the monitor:
 - Shooting burst images using the touch shutter
When [Drive Mode] is set to [Cont. Shooting], you can record burst images while touching the monitor.
 - Shooting burst images of sports scenes using the touch shutter
When [Scene Selection] is set to [Sports Action], you can record burst images while touching the monitor.
 - Shooting continuous bracket images using the touch shutter
The product shoots three images while automatically shifting the exposure from base, to darker, and then to lighter. When [Drive Mode] is set to [Cont. Bracket], keep touching the monitor until the shooting ends. After the recording you can select the image you prefer.

Note

- The [Touch Shutter] function is unavailable in the following situations:
 - When shooting movies
 - When the shooting mode is set to [Sweep Panorama]
 - During [Smile Shutter] mode
 - When [Focus Mode] is [Manual Focus]
 - When [Focus Area] is [Flexible Spot]
 - When [Focus Area] is [Expand Flexible Spot]
 - When [Focus Area] is [Tracking: Flexible Spot]
 - When [Focus Area] is [Tracking: Expand Flexible Spot]
 - While using the digital zoom function
 - While using the  Clear Image Zoom]

Related Topic

- [Touch Operation](#)

Func. of Touch Operation: Touch Focus

[Touch Focus] allows you to specify a position where you want to focus using touch operations. This function is available when [Focus Area] is set to a parameter other than [Flexible Spot], [Expand Flexible Spot], [Tracking: Flexible Spot] or [Tracking: Expand Flexible Spot]. Select MENU →  (Setup) → [Touch Operation] → [On] beforehand.

1 MENU →  (Camera Settings2) → [Func. of Touch Operation] → [Touch Focus].

Specifying the position where you want to focus in the still image mode

You can specify a position where you want to focus using touch operations. After touching the monitor and specifying a position, press the shutter button halfway down to focus.

1. Touch the monitor.
 - Touch the subject to focus.
 - To cancel focusing with touch operations, touch the  (Focus Cancel) icon or press the center of the control wheel.
2. Press the shutter button halfway down to focus.
 - Press the shutter button all the way down to shoot images.

Specifying the position where you want to focus in the movie recording mode (spot focus)

The camera will focus on the touched subject.

1. Touch the subject on which you want to focus before or during recording.
 - To cancel spot focus, touch the  (Focus Cancel) icon or press the center of the control wheel.

Hint

- In addition to the touch focus function, touch operations such as the following are also available.
 - When [Focus Area] is set to [Flexible Spot], [Expand Flexible Spot], [Tracking: Flexible Spot] or [Tracking: Expand Flexible Spot], the focusing frame can be moved using touch operations.
 - When the [Focus Mode] is set to [Manual Focus], the focus magnifier can be used by double-tapping the monitor.

Note

- The touch focus function is not available in the following situations:
 - When the shooting mode is set to [Sweep Panorama].
 - When [Focus Mode] is set to [Manual Focus].
 - When using the digital zoom

Related Topic

- [Touch Operation](#)

Func. of Touch Operation: Touch Tracking



You can use touch operations to select a subject you want to track in the still image and movie recording modes.
Select MENU →  (Setup) → [Touch Operation] → [On] in advance.

- 1 MENU →  2 (Camera Settings2) → [Func. of Touch Operation] → [Touch Tracking].
- 2 Touch the subject that you want to track on the monitor.
Tracking will start.
- 3 Press the shutter button halfway down to focus.
 - Press the shutter button all the way down to shoot images.

Hint

- To cancel tracking, touch the  (Tracking Cancel) icon or press the center of the control wheel.

Note

- [Touch Tracking] is unavailable in the following situations:
 - When [Scene Selection] is [Hand-held Twilight] or [Anti Motion Blur].
 - When shooting movies with [ Record Setting] set to [120p]/[100p].
 - When shooting mode is set to [Sweep Panorama].
 - When [Focus Mode] is set to [Manual Focus] or [DMF]
 - When using the Smart Zoom, Clear Image Zoom and Digital Zoom
 - When [Subject Detection] under [Face/Eye AF Set.] is set to [Animal]
 - When [ File Format] is set to [XAVC S 4K] and [ Proxy Recording] is set to [On]



Related Topic

- [Touch Operation](#)

Digital Camera
ZV-1

File Format (still image)

Sets the file format for still images.

1 MENU →  (Camera Settings1) → [ File Format] → desired setting.

Menu item details

RAW:

Digital processing is not performed on this file format. Select this format to process images on a computer for professional purposes.

RAW & JPEG:

A RAW image and a JPEG image are created at the same time. This is suitable when you need two image files, a JPEG for viewing, and a RAW for editing.

JPEG:

The image is recorded in the JPEG format.

About RAW images

- To open a RAW image file recorded with this camera, the software Imaging Edge is needed. With Imaging Edge, you can open a RAW image file, then convert it into a popular image format such as JPEG or TIFF, or readjust the white balance, saturation or contrast of the image.
- You cannot apply [Auto HDR] or [Picture Effect] functions with RAW images.
- RAW images shot by the camera are recorded in the compressed RAW format.

Note

- If you do not intend to edit the images on your computer, we recommend that you record in JPEG format.
- You cannot add DPOF (print order) registration marks to RAW images.



Related Topic

- [JPEG Quality \(still image\)](#)

Digital Camera
ZV-1

JPEG Quality (still image)

Selects the JPEG image quality when [ File Format] is set to [RAW & JPEG] or [JPEG].

1 MENU →  1 (Camera Settings1) → [ JPEG Quality] → **desired setting.**

Menu item details

Extra fine/Fine/Standard:

Since the compression rate increases from [Extra fine] to [Fine] to [Standard], the file size decreases in the same order. This allows more files to be recorded on one memory card, but the image quality is lower.

Related Topic

- [File Format \(still image\)](#)

Digital Camera
ZV-1

JPEG Image Size (still image)

The larger the image size, the more detail will be reproduced when the image is printed on large-format paper. The smaller the image size, the more images can be recorded.

1 MENU → (Camera Settings1) → [JPEG Image Size] → desired setting.

Menu item details

When [Aspect Ratio] is set to 3:2

Parameter	Number of pixels (horizontal × vertical)
L: 20M	5472×3648 pixels
M: 10M	3888×2592 pixels
S: 5.0M	2736×1824 pixels

When [Aspect Ratio] is set to 4:3

Parameter	Number of pixels (horizontal × vertical)
L: 18M	4864×3648 pixels
M: 10M	3648×2736 pixels
S: 5.0M	2592×1944 pixels
VGA	640×480 pixels

When [Aspect Ratio] is set to 16:9

Parameter	Number of pixels (horizontal × vertical)
L: 17M	5472×3080 pixels
M: 7.5M	3648×2056 pixels
S: 4.2M	2720×1528 pixels

When [Aspect Ratio] is set to 1:1

Parameter	Number of pixels (horizontal × vertical)
L: 13M	3648×3648 pixels
M: 6.5M	2544×2544 pixels
S: 3.7M	1920×1920 pixels

Note

- When [File Format] is set to [RAW] or [RAW & JPEG], the image size for RAW images corresponds to “L.”



Related Topic

- [Aspect Ratio \(still image\)](#)

5-016-934-11(1) Copyright 2020 Sony Corporation

Digital Camera
ZV-1

Aspect Ratio (still image)

1 MENU →  1 (Camera Settings1) → [ Aspect Ratio] → desired setting.

Menu item details

3:2:

Same aspect ratio as 35 mm film

4:3:

The aspect ratio is 4:3.

16:9:

The aspect ratio is 16:9.

1:1:

The horizontal and vertical ratio is equal.

Digital Camera
ZV-1

Panorama: Size

Sets the image size when shooting panoramic images. The image size varies depending on the [Panorama: Direction] setting.

1 MENU →  (Camera Settings1) → [Panorama: Size] → desired setting.

Menu item details

When [Panorama: Direction] is set to [Up] or [Down]

Standard: 3872×2160

Wide: 5536×2160

When [Panorama: Direction] is set to [Left] or [Right]

Standard: 8192×1856

Wide: 12416×1856

Related Topic

- [Sweep Panorama](#)
- [Panorama: Direction](#)

Digital Camera
ZV-1

Panorama: Direction

Sets the direction to pan the camera when shooting panoramic images.

1 MENU →  1 (Camera Settings1) → [Panorama: Direction] → desired setting.

Menu item details

Right:

Pan the camera from the left to the right.

Left:

Pan the camera from the right to the left.

Up:

Pan the camera from the bottom to the top.

Down:

Pan the camera from the top to the bottom.

Related Topic

- [Sweep Panorama](#)

Changing shooting modes (Shoot Mode)

You can set the shooting mode according to the subject you wish to shoot or the function you wish to adjust.

- 1 Press the **MODE (Mode)** button, and then use the control wheel to select the desired shooting mode.

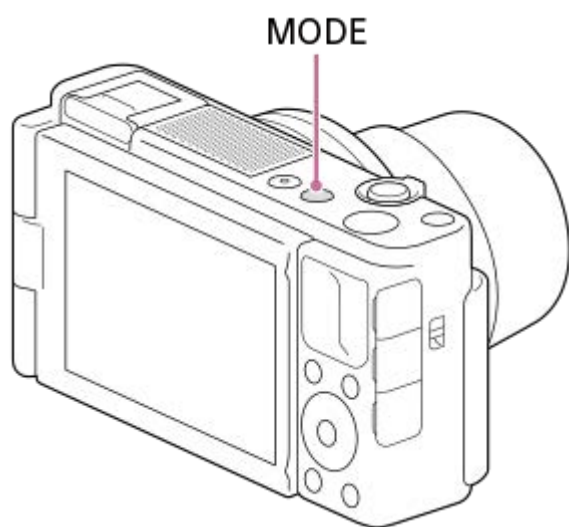

- You can also set the shooting mode by selecting MENU → 1 (Camera Settings1) → [Shoot Mode].

Available functions

(Intelligent Auto):

Allows you to shoot with automatic scene recognition.

P (Program Auto):

Allows you to shoot with the exposure adjusted automatically (both the shutter speed and the aperture value (F value)). Also you can select various settings using the menu.

A (Aperture Priority):

Allows you to adjust the aperture and shoot when you want to blur the background, etc.

S (Shutter Priority):

Allows you to shoot fast-moving subjects etc., by manually adjusting the shutter speed.

M (Manual Exposure):

Allows you to shoot still images with the desired exposure by adjusting the exposure (both the shutter speed and the aperture value (F value)).

(Sweep Panorama):

Allows you to shoot a panoramic image by compositing the images.

SCN (Scene Selection):

Allows you to shoot with preset settings according to the scene.

MR (Memory recall):

Allows you to shoot an image after recalling often-used modes or numeric settings registered in advance.

HFR (High Frame Rate):

Allows you to shoot movies with a higher frame rate than the recording format so that you can record smooth super-slow-motion movies.

(Movie):

Allows you to change the exposure mode for movie recording.

(Intelligent Auto):

Allows you to record movies with automatic scene recognition.

Related Topic

- [Intelligent Auto](#)
- [Program Auto](#)
- [Aperture Priority](#)
- [Shutter Priority](#)
- [Manual Exposure](#)
- [Sweep Panorama](#)
- [Scene Selection](#)
- [Recall \(Camera Settings1/Camera Settings2\)](#)
- [Shooting super-slow-motion movies \(HFR Settings\)](#)
- [HFR \(High Frame Rate\): Exposure Mode](#)
- [Movie: Exposure Mode](#)
- [Intelligent Auto \(movie\)](#)

Intelligent Auto

The camera shoots with automatic scene recognition.

1 MODE (Mode) button → [Intelligent Auto] → press the center of the control wheel.

- You can also set the shooting mode by selecting MENU →  1 (Camera Settings1) → [Shoot Mode].

2 Point the camera at the subject.

When the camera recognized the scene, the icon for the recognized scene appears on the screen.



3 Adjust the focus and shoot the image.

Note

- The product will not recognize the scene when you shoot images with zoom functions other than optical zoom.
- The product may not properly recognize the scene under certain shooting conditions.
- For [Intelligent Auto] mode, most of the functions are set automatically, and you cannot adjust the settings on your own.

Related Topic

- [About Scene Recognition](#)

Digital Camera
ZV-1











About Scene Recognition

Scene Recognition operates in [Intelligent Auto] mode.

This function allows the product to automatically recognize the shooting conditions and shoot the image.



Scene Recognition

When the product recognizes certain scenes, the following icons and guides are displayed on the first line:

-  (Portrait)
-  (Infant)
-  (Night Portrait)
-  (Night Scene)
-  (Backlight Portrait)
-  (Backlight)
-  (Landscape)
-  (Macro)
-  (Spotlight)
-  (Low Light)

When the product recognizes certain conditions, the following icons are displayed on the second line:

-  (Tripod)
-  (Walk)*
-  (Move)
-  (Move (Bright))
-  (Move (Dark))

* The condition  (Walk) is recognized only when [ SteadyShot] is set to [Active].

Related Topic

- [Intelligent Auto](#)
- [Intelligent Auto \(movie\)](#)

Program Auto

Allows you to shoot with the exposure adjusted automatically (both the shutter speed and the aperture value). You can set shooting functions such as [ISO].

- 1 MODE (Mode) button → [Program Auto] → press the center of the control wheel.**
 - You can also set the shooting mode by selecting MENU →  1 (Camera Settings1) → [Shoot Mode].
- 2 Set the shooting functions to your desired settings.**
- 3 Adjust the focus and shoot the subject.**

Program Shift

When you are not using a flash, you can change the shutter speed and aperture (F-value) combination without changing the appropriate exposure set by the camera.

Turn the control wheel to select the aperture value and shutter speed combination.

- “P” on the screen changes to “P*” when you turn the control wheel.
- To cancel program shift, set the shooting mode to other than [Program Auto], or turn off the camera.

Note

- According to the brightness of the environment, the program shift may not be used.
- Set the shooting mode to another one than “P” or turn off the power to cancel the setting you made.
- When the brightness changes, the aperture (F-value) and shutter speed also change while maintaining the shift amount.

Aperture Priority

You can shoot by adjusting the aperture and changing the range in focus, or by defocusing the background.

1 MODE (Mode) button → [Aperture Priority] → press the center of the control wheel.

- You can also set the shooting mode by selecting MENU →  1 (Camera Settings1) → [Shoot Mode].

2 Select the desired value by turning the control wheel.

- Smaller F-value: The subject is in focus, but objects in front of and beyond the subject are blurred.
Larger F-value: The subject and its foreground and background are all in focus.
- If the aperture value you have set is not suitable for appropriate exposure, the shutter speed on the shooting screen will blink. If this happens, change the aperture value.

3 Adjust the focus and shoot the subject.

The shutter speed is automatically adjusted to obtain proper exposure.

Note

- The brightness of the image on the screen may differ from the actual image being shot.

Shutter Priority

You can express the movement of a moving subject in various ways by adjusting the shutter speed, for example, at the instant of the movement with high speed shutter, or as a trailing image with low speed shutter.

1 MODE (Mode) button → [Shutter Priority] → press the center of the control wheel.

- You can also set the shooting mode by selecting MENU →  1 (Camera Settings1) → [Shoot Mode].

2 Select the desired value by turning the control wheel.

- If proper exposure cannot be obtained after setup, the aperture value on the shooting screen blinks. If this happens, change the shutter speed.



3 Adjust the focus and shoot the subject.

The aperture is automatically adjusted to obtain proper exposure.

Hint

- Use a tripod to prevent camera-shake when you have selected a slow shutter speed.
- When you shoot indoor sports scenes, set the ISO sensitivity to a higher value.

Note

- The SteadyShot warning indicator does not appear in shutter speed priority mode.
- When [ Long Exposure NR] is set to [On] and the shutter speed is 1/3 second(s) or longer with a [ Shutter Type] other than [Electronic Shutter] is set, noise reduction after shooting is performed for the same amount of time that the shutter was open. However, you cannot shoot any more while noise reduction is in progress.
- The brightness of the image on the screen may differ from the actual image being shot.

Related Topic

- [Long Exposure NR \(still image\)](#)

Manual Exposure

You can shoot with the desired exposure setting by adjusting both the shutter speed and aperture.

1 MODE (Mode) button → [Manual Exposure] → press the center of the control wheel.

- You can also set the shooting mode by selecting MENU →  1 (Camera Settings1) → [Shoot Mode].

2 Press the down side of the control wheel to select the shutter speed or aperture value, then turn the control wheel to select a value.

- You can also set [ISO] to [ISO AUTO] in manual exposure mode. The ISO value automatically changes to achieve the appropriate exposure using the aperture value and shutter speed you have set.
- When [ISO] is set to [ISO AUTO], the ISO value indicator will blink if the value you have set is not suitable for appropriate exposure. If this happens, change the shutter speed or aperture value.
- When [ISO] is set to other than [ISO AUTO], use MM (Metered Manual)* to check the exposure value.

Toward +: Images become brighter.



Toward -: Images become darker.

0: Appropriate exposure analyzed by the product.

* Indicates under/over for appropriate exposure.

3 Adjust the focus and shoot the subject.

Hint

- By assigning [AEL hold] or [AEL toggle] to a desired key using [ Custom Key] or [ Custom Key] and turning the control wheel while pressing that key, you can change the shutter speed and aperture (F-value) combination without changing the set exposure value. (Manual shift)

Note

- The Metered Manual indicator does not appear when [ISO] is set to [ISO AUTO].
- When the amount of ambient light exceeds the metering range of the Metered Manual, the Metered Manual indicator flashes.
- The SteadyShot warning indicator does not appear in manual exposure mode.
- The brightness of the image on the screen may differ from the actual image being shot.
- You cannot set [ND Filter] to [Auto].

Bulb shooting

You can shoot a trailing image of the movement of a subject with long exposure.

Bulb shooting is suitable for shooting trails from stars or fireworks, etc.



- 1 MODE (Mode) button → [Manual Exposure] → press the center of the control wheel.**
 - You can also set the shooting mode by selecting MENU →  1 (Camera Settings1) → [Shoot Mode].
- 2 Press the down side of the control wheel to select the shutter speed, and turn the control wheel counterclockwise until [BULB] is indicated.**
- 3 Press the down side of the control wheel to select the aperture value (F-value), and turn the control wheel to set the value.**
- 4 Press the shutter button halfway down to focus.**
- 5 Press and hold the shutter button for the duration of the shooting.**

As long as the shutter button is pressed, the shutter remains open.

Hint

- When shooting fireworks, etc., focus at infinity in manual focus mode.
- In order to perform bulb shooting without causing the image quality to deteriorate, we recommend that you start shooting while the camera is cool.
- During bulb shooting, images tend to blur. It is recommended that you use a tripod, a RMT-P1BT Bluetooth remote commander (sold separately) or a remote commander equipped with a lock function (sold separately). When using the RMT-P1BT Bluetooth remote commander, you can start bulb shooting by pressing the shutter button on the remote commander. To stop bulb shooting, press the shutter button on the remote commander again. To use the other remote commander, use the model which can be connected via the Multi/Micro USB terminal.

Note

- The longer the exposure time, the more noise will be visible on the image.
- When [ Long Exposure NR] is set to [On], noise reduction is performed after shooting for the same duration that the shutter was open. You cannot shoot while noise reduction is in progress.
- You cannot set the shutter speed to [BULB] in the following situations:
 - [Smile Shutter]
 - [Auto HDR]
 - [Picture Effect] is set to [HDR Painting] or [Rich-tone Mono.].
 - [Multi Frame NR]
 - When [Drive Mode] is set to the following:
 - [Cont. Shooting]
 - [Self-timer(Cont)]
 - [Cont. Bracket]
 - [ Shutter Type] is set to [Electronic Shutter].

If you use the above functions when the shutter speed is set to [BULB], the shutter speed is temporarily set to 30 seconds.

Related Topic

- [Manual Exposure](#)

5-016-934-11(1) Copyright 2020 Sony Corporation

Sweep Panorama

Allows you to create a single panoramic image from multiple images shot while panning the camera.



- 1 **MODE (Mode) button** → [Sweep Panorama] → **press the center of the control wheel.**
 - You can also set the shooting mode by selecting MENU →  1 (Camera Settings1) → [Shoot Mode].
- 2 **Point the camera at the subject.**
- 3 **While pressing the shutter button halfway down, aim the camera at one end of the desired panoramic composition.**
 - You can change the shooting direction prior to shooting using the control wheel.



(A)

(A) This part will not be shot.

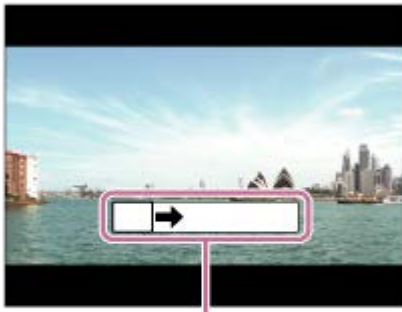

- 4 **Press the shutter button fully down.**
- 5 **Pan the camera to the end of the guide in the direction of the arrow on the monitor.**



(B)

(B) Guidance bar

Note

- If the entire angle of the panoramic shot is not achieved within the set time, a gray area occurs in the composite image. If this happens, move the product faster to record the full panoramic image.
- When [Wide] is selected for [Panorama: Size], the entire angle of the panoramic shot may not be achieved within the given time. If this happens, try shooting after changing [Panorama: Size] to [Standard].
- Since several images are stitched together, the stitched part may not be recorded smoothly in some cases.
- When a light source such as a fluorescent light flickers, the brightness and color of a stitched image may not be consistent.
- When the whole angle of panoramic shooting and the AE/AF locked angle are very different in brightness and focus, the shooting may not be successful. If this happens, change AE/AF locked angle and shoot again.
- The following situations are not suited for shooting Sweep Panorama:
 - Moving subjects.
 - Subjects that are too close to the product.
 - Subjects with continuously similar patterns, such as the sky, beach, or a lawn.
 - Subjects with constant change such as waves or water falls.
 - Subjects with brightness widely different from its surroundings such as the sun or a light bulb.
- The Sweep Panorama shooting may be interrupted in the following situations:
 - When the camera is panned too fast or too slow.
 - When the camera shakes too much.
- Continuous shooting is performed during shooting Sweep Panorama and the shutter sound keeps beeping until shooting is finished.
- The following functions are not available with Sweep Panorama:
 - Smile Shutter
 - Face/Eye Priority in AF
 - Face Priority in Multi Metering
 -  Auto Object Framing
 - DRO/Auto HDR
 - Picture Effect
 - Picture Profile
 - Soft Skin Effect
 -  Long Exposure NR
 - Tracking function
 - Zoom
 - Drive Mode
 - Bright Monitoring
- The values of the settings for some functions are fixed with Sweep Panorama, as follows:
 - [ISO] is fixed to [ISO AUTO].
 - [Focus Area] is fixed to [Wide].
 - [ High ISO NR] is fixed to [Normal].
 - [Flash Mode] is fixed to [Flash Off].

Related Topic

- [Panorama: Size](#)
- [Panorama: Direction](#)

5-016-934-11(1) Copyright 2020 Sony Corporation

Digital Camera
ZV-1

Scene Selection

Allows you to shoot with preset settings according to the scene.

- 1 MODE (Mode) button → [Scene Selection] → press the center of the control wheel.**
 - You can also set the shooting mode by selecting MENU →  1 (Camera Settings1) → [Shoot Mode].
- 2 Turn the control wheel to select the desired setting.**

Menu item details

Portrait:

Blurs background and sharpens the subject. Accentuates the skin tones softly.



Sports Action:

Shoots a moving subject at a fast shutter speed so that the subject looks as if it is standing still. The product shoots images continuously while the shutter button is pressed.



Macro:

Shoots close-ups of the subjects, such as flowers, insects, food, or small items.



Landscape:

Shoots the entire range of a scenery in sharp focus with vivid colors.



Sunset:

Shoots the red of the sunset beautifully.



🌙 Night Scene:

Shoots night scenes without losing the dark atmosphere.



🖐️ Hand-held Twilight:

Shoots night scenes with less noise and blur without using a tripod. A burst of shots are taken, and image processing is applied to reduce subject blur, camera-shake, and noise.



👤🌙 Night Portrait:

Shoots night scene portraits using the flash (sold separately).



👤👤 Anti Motion Blur:

Allows you to shoot indoor shots without using the flash and reduces subject blur. The product shoots burst images and combines them to create the image, reducing subject blur and noise.



🐱 Pet:

Allows you to shoot images of your pet with the best settings.



🍴 Gourmet:

Allows you to shoot food arrangements in delicious and bright colors.



Fireworks:

Allows you to shoot images of fireworks in all their splendor.



High Sensitivity:

Allows you to shoot still images even in dark locations without using the flash, and reduces subject blur. Also allows you to shoot dark movie scenes more brightly.



Hint

- To change the scene, rotate the control wheel on the shooting screen and select a new scene.

Note



- Under the following settings, the shutter speed is slower, so use of a tripod, etc. is recommended to prevent the image from blurring:
 - [Night Scene]
 - [Night Portrait]
 - [Fireworks]
- In the [Hand-held Twilight] or [Anti Motion Blur] mode, the shutter clicks 4 times and an image is recorded.
- If you select [Hand-held Twilight] or [Anti Motion Blur] with [RAW] or [RAW & JPEG], [ File Format] becomes [JPEG] temporarily.
- Reducing blur is less effective even in [Hand-held Twilight] or [Anti Motion Blur] when shooting the following subjects:
 - Subjects with erratic movement.
 - Subjects that are too close to the product.
 - Subjects with continuously similar patterns, such as the sky, a beach, or a lawn.
 - Subjects with constant change such as waves or water falls.
- In the case of [Hand-held Twilight] or [Anti Motion Blur], block noise may occur when using a light source that flickers, such as fluorescent lighting.
- The minimum distance that you can come close to a subject does not change even if you select [Macro]. For the minimum in-focus range, refer to the minimum distance of the lens.
- [Product Showcase Set] and [Background Defocus] are unavailable when the shooting mode is set to [Scene Selection].





Related Topic

- [Using flash \(sold separately\)](#)

Digital Camera
ZV-1

Recall (Camera Settings1/Camera Settings2)



Allows you to shoot an image after recalling often-used modes or camera settings registered with [**MR** 1/2 Memory] in advance.

- 1 MODE (Mode) button → [Memory recall] → press the center of the control wheel.**
 - You can also set the shooting mode by selecting MENU → 1 (Camera Settings1) → [Shoot Mode].
- 2 Press the left/right side of the control wheel or turn the control wheel to select the desired number, then press the center of the control wheel.**
 - You can also recall registered modes or settings by selecting MENU → 1 (Camera Settings1) → [**MR** 1/2 Recall].

Hint

- Settings registered to a memory card using another camera of the same model name can be recalled with this camera.

Note



- If you set [**MR** 1/2 Recall] after completing the shooting settings, the registered settings are given priority and the original settings may become invalid. Check the indicators on the screen before shooting.

Related Topic

- [Memory \(Camera Settings1/Camera Settings2\)](#)

HFR (High Frame Rate): Exposure Mode

You can select the exposure mode for HFR shooting based on the subject and effect you want.

- 1 MODE (Mode) button → [High Frame Rate] → press the center of the control wheel.**
 - You can also set the shooting mode by selecting MENU →  1 (Camera Settings1) → [Shoot Mode].
- 2 MENU →  2 (Camera Settings2) → [HFR Exposure Mode] → desired setting.**

Menu item details

Program Auto:

Allows you to shoot with the exposure adjusted automatically (both the shutter speed and the aperture value).

Aperture Priority:

Allows you to shoot after adjusting the aperture value manually.

Shutter Priority:

Allows you to shoot after adjusting the shutter speed manually.

Manual Exposure:



Allows you to shoot after adjusting the exposure (both the shutter speed and the aperture value) manually.

Related Topic

- [Shooting super-slow-motion movies \(HFR Settings\)](#)

Movie: Exposure Mode

You can set the exposure mode for movie shooting.

- 1 MODE (Mode) button → [Movie] → press the center of the control wheel.**
 - You can also set the shooting mode by selecting MENU →  1 (Camera Settings1) → [Shoot Mode].
- 2 MENU →  2 (Camera Settings2) → [ Exposure Mode] → desired setting.**
- 3 Press the MOVIE (movie) button to start recording.**
 - Press the MOVIE button again to stop recording.

Menu item details

Program Auto:

Allows you to shoot with the exposure adjusted automatically (both the shutter speed and the aperture value).

Aperture Priority:

Allows you to shoot after adjusting the aperture value manually.

Shutter Priority:



Allows you to shoot after adjusting the shutter speed manually.

Manual Exposure:

Allows you to shoot after adjusting the exposure (both the shutter speed and the aperture value) manually.

Intelligent Auto (movie)

The camera shoots movies with automatic scene recognition.

- 1 MODE (Mode) button** → [ Intelligent Auto] → **press the center of the control wheel.**
 - You can also set the shooting mode by selecting MENU →  (Camera Settings1) → [Shoot Mode].
- 2 Point the camera at the subject.**

When the camera recognized the scene, the icon for the recognized scene appears on the screen.
- 3 Press the MOVIE (Movie) button to start recording.**
 - Press the MOVIE button again to stop recording.

Note

- The product will not recognize the scene when you shoot movies with zoom functions other than optical zoom.
- The product may not properly recognize the scene under certain shooting conditions.
- For [ Intelligent Auto] mode, most of the functions are set automatically, and you cannot adjust the settings on your own.

Related Topic

- [About Scene Recognition](#)

Exposure Comp.

Normally, exposure is set automatically (auto exposure). Based on the exposure value set by auto exposure, you can make the entire image brighter or darker if you adjust [Exposure Comp.] to the plus side or minus side, respectively (exposure compensation).

- 1  (Exposure Comp.) on the control wheel → press the left/right side of the control wheel or turn the control wheel, and select the desired setting.

+ (over) side:

Images become brighter.

- (under) side:

Images become darker.

- You can also select MENU →  1 (Camera Settings1) → [Exposure Comp.].

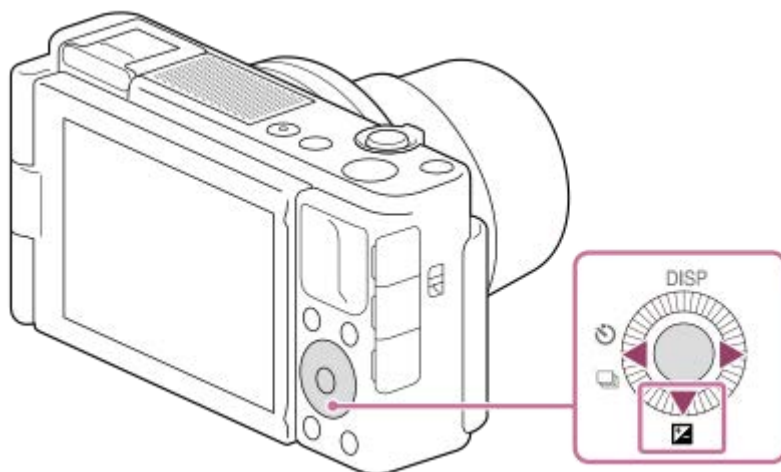

- You can adjust the exposure compensation value within the range of -3.0 EV to +3.0 EV.
- You can confirm the exposure compensation value that you set on the shooting screen.

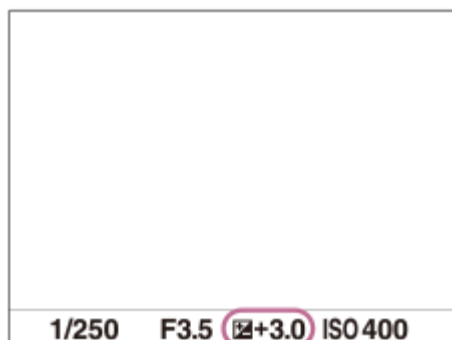

Note

- You cannot perform the exposure compensation in the following shooting modes:
 - [Intelligent Auto]
 - [Scene Selection]
 - [ Intelligent Auto]
- When using [Manual Exposure], you can perform the exposure compensation only when [ISO] is set to [ISO AUTO].

- You can adjust the exposure compensation value within the range of -2.0 EV to +2.0 EV for movies.
- If you shoot a subject in extremely bright or dark conditions, or when you use the flash, you may not be able to get a satisfactory effect.

Related Topic

- [Exp.comp.set](#)
- [Cont. Bracket](#)
- [Single Bracket](#)
- [Zebra Setting](#)

5-016-934-11(1) Copyright 2020 Sony Corporation

Digital Camera
ZV-1

Exposure Set. Guide

You can set whether to display a guide when you change the exposure.

1 MENU →  2 (Camera Settings2) → [Exposure Set. Guide] → desired setting.

Menu item details

Off:

Does not display the guide.

On:

Displays the guide.

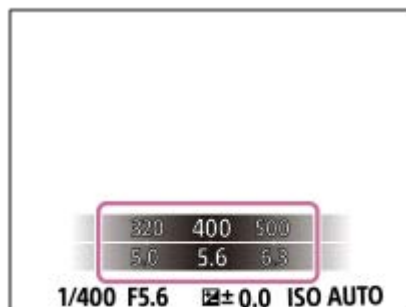

Digital Camera
ZV-1

ND Filter

If you use an ND filter, the amount of light entering the camera is reduced. You can slow down the shutter speed and decrease the aperture value for a better exposure.

1 MENU →  1 (Camera Settings1) → [ND Filter] → desired setting.

Menu item details

 **Auto:**

Automatically turns on the ND filter based on the shooting mode and brightness.

 **On:**

Always uses [ND Filter].

 **Off:**

Disables the [ND Filter] function.

Hint

- When the ND filter is activated, the icon is displayed on the bottom of the screen.

Note

- [Auto] cannot be selected in the movie mode. When recording movies, the setting for [ND Filter] is locked to the value at the start of movie recording.

Metering Mode

Selects the metering mode that sets which part of the screen to measure for determining the exposure.

1 MENU →  (Camera Settings1) → [Metering Mode] → desired setting.

Menu item details

Multi:

Measures light on each area after dividing the total area into multiple areas and determines the proper exposure of the entire screen (Multi-pattern metering).

Center:

Measures the average brightness of the entire screen, while emphasizing the central area of the screen (Center-weighted metering).

Spot:

Measures only inside the metering circle. This mode is suitable for measuring light at the center of the screen. The size of the metering circle can be selected from [Spot: Standard] and [Spot: Large].

Entire Screen Avg.:

Measures the average brightness of the entire screen. The exposure will be stable even if the composition or the position of the subject changes.

Highlight:

Measures the brightness while emphasizing the highlighted area on the screen. This mode is suitable for shooting the subject while avoiding overexposure.

Hint

- When [Multi] is selected and [Face Priority in Multi Metering] is set to [On], the camera measures brightness based on detected faces.
- When [Metering Mode] is set to [Highlight] and the [D-Range Optimizer] or [Auto HDR] function is activated, the brightness and the contrast will be corrected automatically by dividing the image into small areas and analyzing the contrast of light and shadow. Make settings based on the shooting circumstances.

Note

- [Metering Mode] is locked to [Multi] in the following shooting modes:
 - [Intelligent Auto]
 - [Scene Selection]
 - [ Intelligent Auto]
 - Other zoom functions than the optical zoom
- In [Highlight] mode, the subject may be dark if a brighter part exists on the screen.

Related Topic

- [AE lock](#)
- [Face Priority in Multi Metering](#)
- [D-Range Optimizer \(DRO\)](#)
- [Auto HDR](#)

Face Priority in Multi Metering

Sets whether the camera measures brightness based on detected faces when [Metering Mode] is set to [Multi].

1 MENU →  1 (Camera Settings1) → [Face Priority in Multi Metering] → desired setting.

Menu item details

On:

The camera measures brightness based on detected faces.

Off:

The camera measures brightness using the [Multi] setting, without detecting faces.

Note





- When the shooting mode is set to [Intelligent Auto] or [ Intelligent Auto], [Face Priority in Multi Metering] is locked to [On].
- When [Face/Eye Priority in AF] is set to [On] and [Subject Detection] is set to [Animal] under [Face/Eye AF Set.], [Face Priority in Multi Metering] does not work.

Related Topic



- [Metering Mode](#)

AE lock



When the contrast between the subject and background is high, such as when shooting a backlit subject or a subject near a window, meter the light at a spot where the subject appears to have the appropriate brightness and lock the exposure before shooting. To reduce the brightness of the subject, meter the light at a spot brighter than the subject and lock the exposure of the entire screen. To make the subject brighter, meter the light at a spot darker than the subject and lock the exposure of the entire screen.

- 1 MENU** →  **2 (Camera Settings2)** → [ **Custom Key**] or [ **Custom Key**] → **desired key, then assign [AEL toggle] to the key.**
- 2 Adjust the focus on the spot at which the exposure is adjusted.**
- 3 Press the button to which [AEL toggle] is assigned.**
The exposure is locked, and  (AE lock) is displayed.
- 4 Focus on the subject again and press the shutter button.**
 - To cancel the exposure lock, press the button to which the [AEL toggle] function is assigned.

Hint

- If you select the [AEL hold] function in [ **Custom Key**] or [ **Custom Key**], you can lock the exposure as long as you are holding down the button. You cannot set the [AEL hold] function to [Left Button] or [Right Button].

Note

- [ **AEL hold**] and [ **AEL toggle**] are not available when using zoom functions other than optical zoom.

Digital Camera
ZV-1

Exp.comp.set

Sets whether to apply the exposure compensation value to control both flash light and ambient light, or just ambient light.

1 MENU →  (Camera Settings1) → [Exp.comp.set] → desired setting.

Menu item details

Ambient&flash:

Applies the exposure compensation value to control both flash light and ambient light.

Ambient only:

Applies the exposure compensation value to control ambient light only.

Related Topic

- [Flash Comp.](#)

Digital Camera
ZV-1

Zebra Setting

Sets a zebra pattern, which appears over part of an image if the brightness level of that part meets the IRE level that you have set. Use this zebra pattern as a guide to adjust the brightness.

1 MENU →  2 (Camera Settings2) → [Zebra Setting] → desired setting.

Menu item details

Zebra Display:

Sets whether to display the zebra pattern.

Zebra Level:

Adjusts the brightness level of the zebra pattern.

Hint

- You can register values to check the correct exposure or overexposure as well as the brightness level for [Zebra Level]. The settings for correct exposure confirmation and overexposure confirmation are registered to [Custom1] and [Custom2] respectively in the default settings.
- To check the correct exposure, set a standard value and the range for the brightness level. The zebra pattern will appear on areas that fall within the range you set.
- To check the overexposure, set a minimum value for the brightness level. The zebra pattern will appear over areas with a brightness level equal to or higher than the value you set.

Note

- The zebra pattern is not displayed on devices connected via HDMI.

Product Showcase Set

The camera settings are optimally configured for situations such as movie shooting for product reviews. The camera tends to focus on objects that are closer to it.

1 MENU →  1 (Camera Settings1) → [Product Showcase Set] → desired setting.

Menu item details



On:

Shoots with optimal settings for product reviews. [Face/Eye Priority in AF] under [Face/Eye AF Set.] and [ SteadyShot] are both locked to [Off].

Off:

Shoots in the ordinary shooting mode.

Hint

- When you assign [Product Showcase Set] to a desired key using MENU →  2 (Camera Settings2) → [ Custom Key] or [ Custom Key], each time you press the key, [Product Showcase Set] switches between [On] and [Off]. In the default settings, [Product Showcase Set] is assigned to the C2 button.

Note

- [Product Showcase Set] is not available in the following shooting modes:
 - [Sweep Panorama]
 - [Scene Selection]
- Settings for [Product Showcase Set] cannot be changed during movie recording.
- Since [ SteadyShot] becomes set to [Off], we recommend that you use a tripod.

Background Defocus

You can change the level of defocus in the background simply by pressing a key while shooting still images or movies.





1 MENU →  2 (Camera Settings2) → [ Custom Key] or [ Custom Key] → desired key. Then, assign the [Background Defocus] function to the key.

2 Repeatedly press the key to which [Background Defocus] is assigned.

Once you press the key, the [Background Defocus] mode is activated and the background becomes defocused. Afterwards, the level of defocus in the background switches between [Defocus] and [Clear] each time you press the key.

- The camera returns to the ordinary mode and the aperture returns to the former value when you press the MODE (Mode) button.

Hint

- In the default settings, [Background Defocus] is assigned to the C1 button.
- The aperture value becomes locked and the icon  (Defocus) or  (Clear) is indicated instead of the aperture value in the [Background Defocus] mode. The aperture value is locked at wide open when  (Defocus) is indicated. The aperture value is locked at F5.6 when  (Clear) is indicated.

Note

- [Background Defocus] is not available in the following shooting modes:
 - [Sweep Panorama]
 - [Scene Selection]
- The [Background Defocus] mode is canceled, the camera returns to the ordinary mode, and the aperture returns to the former value when you perform the following operations:
 - Turning the power off and back on again
 - Pressing the MODE button
 - Pressing the MENU button
 - Changing the aperture value using the control wheel while the shooting mode is set to [Aperture Priority] or [Manual Exposure]
 - Program shift
 - Manual shift
 - Exposure compensation
- Even if you press the key, you cannot change the level of defocus while using [Set Focus] or [Focus Magnifier] in the [Background Defocus] mode.
- Depending on the shooting mode and shooting conditions, the camera may be unable to obtain the optimal exposure due to the locking of the aperture value in the [Background Defocus] mode.

Related Topic

- [Assigning frequently used functions to buttons \(Custom Key\)](#)



Digital Camera
ZV-1

D-Range Optimizer (DRO)

By dividing the image into small areas, the product analyzes the contrast of light and shadow between the subject and the background, and creates an image with the optimal brightness and gradation.

- 1 MENU →  (Camera Settings1) → [DRO/Auto HDR] → [D-Range Optimizer].
- 2 Select the desired setting using the left/right sides of the control wheel.

Menu item details

D-Range Optimizer: Auto:

Corrects the brightness automatically.

D-Range Optimizer: Lv1 — D-Range Optimizer: Lv5:

Optimizes the gradation of a recorded image for each divided area. Select the optimization level from Lv1 (weak) to Lv5 (strong).

Note

- In the following situations, [DRO/Auto HDR] is fixed to [Off]:
 - The shooting mode is set to [Sweep Panorama].
 - Multi Frame NR
 - When [Picture Effect] is set to other than [Off]
 - When [Picture Profile] is set to other than [Off]
- [DRO/Auto HDR] is fixed to [Off] when the following modes are selected in [Scene Selection].
 - [Sunset]
 - [Night Scene]
 - [Night Portrait]
 - [Hand-held Twilight]
 - [Anti Motion Blur]
 - [Fireworks]

The setting is fixed to [D-Range Optimizer: Auto] when [Scene Selection] modes other than the above modes are selected.
- When [ Record Setting] is set to [120p 100M], [100p 100M], [120p 60M], or [100p 60M], [DRO/Auto HDR] switches to [Off].
- When shooting with [D-Range Optimizer], the image may be noisy. Select the proper level by checking the recorded image, especially when you enhance the effect.

Digital Camera
ZV-1

Auto HDR

Shoots three images using different exposures and combines the images with correct exposure, the bright parts of an underexposed image, and the dark parts of an overexposed image to create images with a greater range of gradation (High Dynamic Range). One image with proper exposure and one overlaid image are recorded.

1 MENU →  1 (Camera Settings1) → [DRO/Auto HDR] → [Auto HDR].

2 Select the desired setting using the left/right sides of the control wheel.

Menu item details

 **Auto HDR: Exposure Diff. Auto:**

Corrects the brightness automatically.

 **Auto HDR: Exposure Diff. 1.0EV — Auto HDR: Exposure Diff. 6.0EV:**



Sets the exposure difference, based on the contrast of the subject. Select the optimization level from 1.0EV (weak) to 6.0EV (strong).

For example, if you set the exposure value to 2.0 EV, three images will be composed with the following exposure levels: -1.0 EV, correct exposure and +1.0 EV.

Hint

- The shutter is released three times for one shot. Be careful about the following:
 - Use this function when the subject is motionless or does not flash light.
 - Do not change the composition during shooting.

Note

- This function is not available when the [ File Format] is [RAW] or [RAW & JPEG].
- [Auto HDR] is not available in the following shooting modes:
 - [Intelligent Auto]
 - [Sweep Panorama]
 - [Scene Selection]
- [Auto HDR] is not available in the following situations:
 - When [Multi Frame NR] is selected.
 - When [Picture Effect] is set to other than [Off].
 - When [Picture Profile] is set to other than [Off].
- You cannot start the next shot until the capture process is completed after you shoot.
- You may not obtain the desired effect depending on the luminance difference of a subject and the shooting conditions.
- When the flash is used, this function has little effect.
- When the contrast of the scene is low or when product shake or subject blur occurs, you may not obtain good HDR images.   (Auto HDR error) will be displayed over the recorded image to inform you when the camera detects image blurring. Change the composition or re-shoot the image carefully to avoid image blur, as needed.

ISO

Sensitivity to light is expressed by the ISO number (recommended exposure index). The larger the number, the higher the sensitivity.

- 1 **MENU** →  (**Camera Settings1**) → **[ISO]** → **desired setting**.

Menu item details

Multi Frame NR:

Combines continuous shots to create an image with less noise. Press the right side to display the setting screen, then select a desired value using the top/bottom sides of the control wheel.

Select the desired ISO number from ISO AUTO or ISO 200 – ISO 25600.

ISO AUTO:

Sets the ISO sensitivity automatically.



ISO 80 – ISO 12800:

Sets the ISO sensitivity manually. Selecting a larger number increases the ISO sensitivity.

Hint

- You can change the range of ISO sensitivity that is set automatically in [ISO AUTO] mode. Select [ISO AUTO] and press the right side of the control wheel, and set the desired values for [ISO AUTO Maximum] and [ISO AUTO Minimum]. The values are also applied when shooting in [ISO AUTO] mode under [Multi Frame NR].

Note

- When [ File Format] is set to [RAW] or [RAW & JPEG], [Multi Frame NR] cannot be selected.
- When [Multi Frame NR] is selected, the flash (sold separately), [D-Range Optimizer], or [Auto HDR] cannot be used.
- When [Picture Profile] is set to other than [Off], [Multi Frame NR] cannot be selected.
- When [Picture Effect] is set to other than [Off], [Multi Frame NR] cannot be selected.
- [ISO AUTO] is selected when using the following functions:
 - [Intelligent Auto]
 - [Scene Selection]
 - [Sweep Panorama]
 - [ Intelligent Auto]
- When the ISO sensitivity is set to a value lower than ISO 125, the range for recordable subject brightness (dynamic range) may decrease.
- The higher the ISO value, the more noise will appear on the images.
- The available ISO settings will differ depending on whether you are shooting still images, shooting movies, or using HFR.
- [Multi Frame NR] is not available when [Drive Mode] is set to [Cont. Shooting].
- When shooting movies, ISO values between 125 and 12800 are available. If the ISO value is set to a value smaller than 125, the setting is automatically switched to 125. When you finish recording the movie, the ISO value returns to the original setting.
- The available range for ISO sensitivity varies depending on the setting for [Gamma] under [Picture Profile].
- When you use [Multi Frame NR], it takes some time for the product to perform the overlay processing of images.
- When you select [ISO AUTO] with the shooting mode set to [P], [A], [S] or [M], the ISO sensitivity will be automatically adjusted within the set range.

The zoom features available with this product

The zoom feature of the product provides a higher magnification zoom by combining various zoom features. The icon displayed on the screen changes, according to the selected zoom feature.

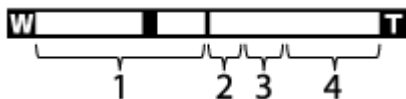

1. Optical zoom range

Images are magnified within the optical zoom range of this product.

2. Smart Zoom range ()

Zoom images without causing the original quality to deteriorate by partially cropping an image (only when [ JPEG Image Size] is set to [M], [S] or [VGA]).







3. Clear Image Zoom range ()

Zoom images using an image process with less deterioration. When you set [Zoom Setting] to [ClearImage Zoom] or [Digital Zoom], you can use this zoom function.

4. Digital Zoom range ()

You can magnify images using an image process. When you set [Zoom Setting] to [Digital Zoom], you can use this zoom function.

Note

- The default setting for the [Zoom Setting] is [Optical zoom only].
- The default setting for the [ JPEG Image Size] is [L]. To use the smart zoom, change [ JPEG Image Size] to [M], [S] or [VGA].
- Zooming is not available when shooting panoramic images.
- The Smart Zoom, Clear Image Zoom and Digital Zoom functions are not available when shooting in the following situations:
 - [ File Format] is set to [RAW] or [RAW & JPEG].
 - [ Record Setting] is set to [120p]/[100p].
 - During High Frame Rate shooting
 - During continuous shooting with [ Shutter Type] set to [Auto] or [Electronic Shutter]
- You cannot use the Smart Zoom function with movies.
- Zooming is not available when the screen is set to HFR (High Frame Rate) shooting.
- When you use a zoom function other than the optical zoom, the [Focus Area] setting is disabled and the focusing frame is shown by the dotted line. The AF operates with priority on and around the center area.
- When you use the Smart Zoom, Clear Image Zoom or Digital Zoom function, [Metering Mode] is locked to [Multi].
- When using the Smart Zoom, Clear Image Zoom or Digital Zoom function, the following functions are not available:
 - Face/Eye Priority in AF
 - Face Priority in Multi Metering
 - Tracking function
 -  Auto Object Framing

- [Zoom](#)
- [Zoom Setting](#)
- [About zoom scale](#)
- [Focus Area](#)

5-016-934-11(1) Copyright 2020 Sony Corporation

Digital Camera
ZV-1

Zoom

Enlarge images using the W/T (zoom) lever when shooting.

1 Enlarge images with the W/T (zoom) lever when shooting.

- Move the W/T (zoom) lever to the T side to zoom in and to the W side to zoom out.

Hint

- When you select other than [Optical zoom only] for [Zoom Setting], you can exceed the zoom range of the optical zoom to zoom images.

Related Topic

- [Zoom Setting](#)
- [The zoom features available with this product](#)
- [Zoom Speed](#)

Digital Camera
ZV-1

Zoom Setting

You can select the zoom setting of the product.

1 MENU →  2 (Camera Settings2) → [Zoom Setting] → desired setting.

Menu item details

Optical zoom only:

Limits the zoom range to the optical zoom. You can use the Smart Zoom function if you set [ JPEG Image Size] to [M], [S] or [VGA].

ClearImage Zoom :

Select this setting to use Clear Image Zoom. Even if the zoom range exceeds the optical zoom, the product magnifies images using an image process with less deterioration.

Digital Zoom :

When the zoom range of the Clear Image Zoom is exceeded, the product magnifies images to the largest scale. However, the image quality will deteriorate.

Note

- Set [Optical zoom only] if you want to magnify images within the range in which image quality does not deteriorate.

Related Topic

- [The zoom features available with this product](#)
- [About zoom scale](#)

About zoom scale

The zoom scale that is used in combination with the zoom of the lens changes according to the selected image size.

When [ Aspect Ratio] is [3:2]

 JPEG Image Size	Optical zoom only (smart zoom)	ClearImage Zoom	Digital Zoom
L: 20M	-	Approx. 2.0×	Approx. 4.0×
M: 10M	Approx. 1.4×	Approx. 2.8×	Approx. 5.6×
S: 5.0M	Approx. 2.0×	Approx. 4.0×	Approx. 8.0×

Related Topic

- [Zoom](#)
- [The zoom features available with this product](#)
- [Zoom Setting](#)
- [JPEG Image Size \(still image\)](#)

Zoom Speed

Sets the zoom speed of the camera's zoom lever.

1 MENU →  2 (Camera Settings2) → [Zoom Speed] → desired setting.

Menu item details

Normal:

Sets the zoom speed of the zoom lever to normal.

Fast:

Sets the zoom speed of the zoom lever to fast.

Hint

- The [Zoom Speed] settings are also used when you are zooming with a remote controller (sold separately) connected to the camera.

Note

- Selecting [Fast] increases the likelihood that the zoom sound will be recorded.

Related Topic

- [Zoom](#)

Digital Camera
ZV-1

White Balance

Corrects the tone effect of the ambient light condition to record a neutral white subject in white. Use this function when the color tones of the image did not come out as you expected, or when you want to change the color tones on purpose for photographic expression.

1 MENU → 1 (Camera Settings1) → [White Balance] → desired setting.

Menu item details

AWB **Auto** / Daylight / Shade / Cloudy / Incandescent / -1 Fluor.: Warm White / 0 Fluor.: Cool White / +1 Fluor.: Day White / +2 Fluor.: Daylight / Flash / Underwater Auto :

When you select a light source that illuminates the subject, the product adjusts the color tones to suit to the selected light source (preset white balance). When you select [Auto], the product automatically detects the light source and adjusts the color tones.

C.Temp./Filter:

Adjusts the color tones depending on the light source. Achieves the effect of CC (Color Compensation) filters for photography.

Custom 1/Custom 2/Custom 3:

Memorizes the basic white color under the light conditions for the shooting environment.

Hint

- You can display the fine adjustment screen and perform fine adjustments of the color tones as required by pressing the right side of the control wheel.
- If the color tones do not come out as you expected in the selected settings, perform [WB bracket] shooting.
- (Ambience) or (White) is displayed only when [Priority Set in AWB] is set to [Ambience] or [White].

Note

- [White Balance] is fixed to [Auto] in the following shooting modes:
 - [Intelligent Auto]
 - [Scene Selection]
 - [Intelligent Auto]
- If you use a mercury lamp or a sodium lamp as a light source, the accurate white balance will not be obtained because of the characteristics of the light. It is recommended to shoot images using a flash (sold separately) or select [Custom 1] to [Custom 3].

Related Topic

- [Capturing a standard white color to set the white balance \(custom white balance\)](#)
- [Priority Set in AWB](#)
- [WB bracket](#)

Digital Camera
ZV-1

Priority Set in AWB

Selects which tone to prioritize when shooting under lighting conditions such as incandescent light when [White Balance] is set to [Auto].

1 MENU →  1 (Camera Settings1) → [Priority Set in AWB] → desired setting.

Menu item details

AWB
STD **Standard:**

Shoots with standard auto white balance. The camera automatically adjusts the color tones.

AWB
Ambi **Ambience:**

Prioritizes the color tone of the light source. This is suitable when you want to produce a warm atmosphere.

AWB
White **White:**

Prioritizes a reproduction of white color when the color temperature of the light source is low.

Related Topic

- [White Balance](#)

Capturing a standard white color to set the white balance (custom white balance)

In a scene where the ambient light consists of multiple types of light sources, it is recommended to use the custom white balance in order to accurately reproduce the whiteness. You can register 3 settings.

1 MENU →  1 (Camera Settings1) → [White Balance] → Select from among [Custom 1] to [Custom 3], and then press the right side of the control wheel.

2 Select  SET (custom white balance set), and then press the center of the control wheel.

3 Hold the product so that the white area fully covers the white-balance capture frame, and then press the center of the control wheel.

After the shutter sound beeps, the calibrated values (Color Temperature and Color Filter) are displayed.

- You can adjust the position of the white-balance capture frame by pressing the top/bottom/left/right side of the control wheel.
- After capturing a standard white color, you can display the fine adjustment screen by pressing the right side of the control wheel. You can finely adjust the color tones as needed.

4 Press the center of the control wheel.

The calibrated values will be registered. The monitor returns to the MENU display while retaining the memorized custom white balance setting.

- The registered custom white balance setting will remain memorized until overwritten by the another setting.





Note

- The message [Capturing of the custom WB failed.] indicates that the value is in the unexpected range, for example when the subject is too vivid. You can register the setting at this point, but it is recommended that you set the white balance again. When an error value is set, the indicator  (custom white balance) turns orange on the recording information display. The indicator will be displayed in white when the set value is in the expected range.
- If you use a flash (sold separately) when capturing a basic white color, the custom white balance will be registered with the lighting from the flash. Be sure to use a flash whenever you shoot with recalled settings that were registered with a flash.

Digital Camera
ZV-1

Creative Style

Allows you to set the desired image processing and finely adjust contrast, saturation and sharpness for each image style. You can adjust exposure (shutter speed and aperture) as you like with this function, unlike with [Scene Selection], where the product adjusts the exposure.

- 1 MENU →  1 (Camera Settings1) → [Creative Style].
- 2 Select the desired style using the top/bottom sides of the control wheel.
- 3 To adjust  (Contrast),  (Saturation) and  (Sharpness), select the desired item using the right/left sides, and then select the value using the top/bottom sides.

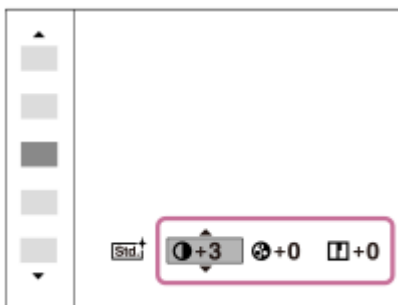

Menu item details

Standard:

For shooting various scenes with rich gradation and beautiful colors.

Vivid:

The saturation and contrast are heightened for shooting striking images of colorful scenes and subjects such as flowers, spring greenery, blue sky, or ocean views.

Portrait:

For capturing skin in a soft tone, ideally suited for shooting portraits.

Landscape:

The saturation, contrast, and sharpness are heightened for shooting vivid and crisp scenery. Distant landscapes also stand out more.

Sunset:

For shooting the beautiful red of the setting sun.

Black & White:

For shooting images in black and white monotone.

Sepia:

For shooting images in sepia monotone.

To set [Contrast], [Saturation] and [Sharpness]

[Contrast], [Saturation], and [Sharpness] can be adjusted for each image style preset such as [Standard] and [Landscape].

Select an item to be set by pressing the right/left sides of the control wheel, then set the value using the top/bottom sides of the control wheel.

Contrast:

The higher the value selected, the more the difference of light and shadow is accentuated, and the bigger the effect on the image.

 **Saturation:**

The higher the value selected, the more vivid the color. When a lower value is selected, the color of the image is restrained and subdued.

 **Sharpness:**

Adjusts the sharpness. The higher the value selected, the more the contours are accentuated, and the lower the value selected, the more the contours are softened.

Note

- [Creative Style] is fixed to [Standard] in the following situations:
 - [Intelligent Auto]
 - [Scene Selection]
 - [ Intelligent Auto]
 - [Picture Effect] is set to other than [Off].
 - [Picture Profile] is set to other than [Off].

- When this function is set to [Black & White] or [Sepia], [Saturation] cannot be adjusted.

Digital Camera
ZV-1

Picture Effect

Select the desired effect filter to achieve more impressive and artistic images.

1 MENU →  (Camera Settings1) → [Picture Effect] → desired setting.

Menu item details

 **Off:**

Disables the [Picture Effect] function.

 **Toy Camera:**

Creates a soft image with shaded corners and reduced sharpness.

 **Pop Color:**

Creates a vivid look by emphasizing color tones.

 **Posterization:**

Creates a high contrast, abstract look by heavily emphasizing primary colors, or in black and white.

 **Retro Photo:**

Creates the look of an aged photo with sepia color tones and faded contrast.

 **Soft High-key:**

Creates an image with the indicated atmosphere: bright, transparent, ethereal, tender, soft.

 **Partial Color:**

Creates an image which retains a specific color, but converts others to black and white.

 **High Contrast Mono.:**

Creates a high-contrast image in black and white.

 **Soft Focus:**

Creates an image filled with a soft lighting effect.

 **HDR Painting:**

Creates the look of a painting, enhancing the colors and details.

 **Rich-tone Mono.:**

Creates an image in black and white with rich gradation and reproduction of details.

 **Miniature:**

Creates an image which enhances the subject vividly, with the background defocused considerably. This effect may often be found in pictures of miniature models.

 **Watercolor:**

Creates an image with ink bleed and blurring effects as if painted using watercolors.

 **Illustration:**

Creates an illustration-like image by emphasizing the outlines.

Hint



- You can perform detailed settings for some items using the left/right sides of the control wheel.

Note

- When you use a zoom function other than the optical zoom, setting the zoom scale larger makes [Toy Camera] less effective.
- When [Partial Color] is selected, images may not retain the selected color, depending on the subject or shooting conditions.
- You cannot check the following effects on the shooting screen, because the product processes the image after the shot. Also, you cannot shoot another image until image processing is finished. You cannot use these effects with movies.
 - [Soft Focus]
 - [HDR Painting]

- [Rich-tone Mono.]
 - [Miniature]
 - [Watercolor]
 - [Illustration]
- In the case of [HDR Painting] and [Rich-tone Mono.], the shutter is released three times for one shot. Be careful about the following:
 - Use this function when the subject is motionless or does not flash light.
 - Do not change the composition during shooting.

When the contrast of the scene is low or when significant camera-shake or subject blur has occurred, you may not be able to obtain good HDR images. If the product detects such a situation,  (Picture Effect error) will appear on the recorded image to inform you of this situation. Change the composition or re-shoot the image carefully to avoid image blur, as needed.

- This function is not available in the following shooting modes:
 - [Intelligent Auto]
 - [Scene Selection]
 - [Sweep Panorama]
 - [ Intelligent Auto]
- When [ File Format] is set to [RAW] or [RAW & JPEG], this function is not available.

Digital Camera
ZV-1

Soft Skin Effect

Sets the effect used for shooting the skin smoothly in the Face Detection function.

1 MENU →  1 (Camera Settings1) → [Soft Skin Effect] → desired setting.

Menu item details













 Off:

Does not use the [Soft Skin Effect] function.

 On:

Uses the [Soft Skin Effect]. You can set the effect level by pressing the right/left side of the control wheel.

Note

- [Soft Skin Effect] is not available when [ File Format] is [RAW].
- [Soft Skin Effect] is not available for RAW images when the [ File Format] is [RAW & JPEG].
- [Soft Skin Effect] is not applied to still images shot using the Dual Rec function.
- [Soft Skin Effect] is not available in the following situations.
 - When the shooting mode is set to [Sweep Panorama]
 - During shooting standby or recording with the shooting mode set to [High Frame Rate]
 - When the shooting mode is set to [Landscape], [Sunset], [Night Scene], [Pet], [Gourmet], or [Fireworks] under [Scene Selection]
 - When [Picture Effect] is set to [Posterization]
 - While using the digital zoom function
- When the shooting mode is [Movie], [Soft Skin Effect] is not available in the following situations.
 - [ File Format] is set to [XAVC S 4K], and [ Proxy Recording] is set to [On].
 - [ File Format] is set to [XAVC S 4K], [ Record Setting] is set to [30p 100M] or [30p 60M], and [ 4K Output Select] is set to [Memory Card+HDMI].
 - [ File Format] is set to [XAVC S 4K], and [PC Remote] is set to [On].
 - [ File Format] is set to [XAVC S 4K], and [Ctrl w/ Smartphone] is in use.
 - [ File Format] is set to [XAVC S HD], and [ Record Setting] is set to [120p]/[100p].
- When the shooting mode is [Movie] or [ Intelligent Auto] and [ File Format] is set to [XAVC S 4K], the effect is not applied to the image on the monitor during shooting, but it is applied to the recorded image.

Digital Camera
ZV-1

Auto Object Framing (still image)

When this product detects and shoots faces, macro shooting subjects or subjects that are tracked by [Tracking], the product automatically trims the image into an appropriate composition, and then saves it. Both the original and the trimmed images are saved. The trimmed image is recorded in the same size as the original image size.

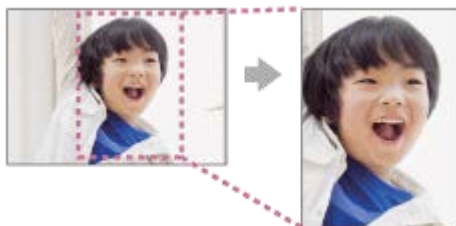

1 MENU → 1 (Camera Settings1) → Auto Object Framing → desired setting.

Menu item details

Off:

Does not trim images.

Auto:

Automatically trims images into an appropriate composition.



Note

- The trimmed image may not be the best possible composition, depending on the shooting conditions.
- [Auto Object Framing] cannot be set when [File Format] is set to [RAW] or [RAW & JPEG].
- [Auto Object Framing] is not available in the following situations.
 - When shooting movies
 - The shooting mode is set to [Sweep Panorama]
 - The shooting mode is set to [Hand-held Twilight], [Sports Action], [Anti Motion Blur], or [Fireworks] in [Scene Selection]
 - [Drive Mode] is set to [Cont. Shooting], [Self-timer(Cont)], [Cont. Bracket], [Single Bracket], [WB bracket], or [DRO Bracket].
 - The ISO sensitivity is set to [Multi Frame NR].
 - [DRO/Auto HDR] is set to [Auto HDR].
 - Other zoom functions than the optical zoom
 - When shooting in Manual Focus mode
 - [Picture Effect] is set to [Soft Focus], [HDR Painting], [Rich-tone Mono.], [Miniature], [Watercolor], or [Illustration].

Digital Camera
ZV-1

Color Space (still image)

The way colors are represented using combinations of numbers or the range of color reproduction is called “color space.” You can change the color space depending on the purpose of the image.

1 MENU →  (Camera Settings1) → [ Color Space] → desired setting.

Menu item details

sRGB:

This is the standard color space of the digital camera. Use [sRGB] in normal shooting, such as when you intend to print out the images without any modification.

AdobeRGB:



This color space has a wide range of color reproduction. When a large part of the subject is vivid green or red, Adobe RGB is effective. The file name of the recorded image starts with “_.”

Note

- [AdobeRGB] is for applications or printers that support color management and DCF2.0 option color space. Images may not be printed or viewed in the correct colors if you use applications or printers that do not support Adobe RGB.
- When displaying images that were recorded with [AdobeRGB] on non-Adobe RGB-compliant devices, the images will be displayed with low saturation.

Shutter Type (still image)

You can set whether to shoot with a mechanical shutter or an electronic shutter.

1 MENU →  2 (Camera Settings2) → [ Shutter Type] → desired setting.

Menu item details

Auto:

The shutter type is automatically switched based on the shooting conditions and shutter speed.



Mechanical Shutter:

Shoot with the mechanical shutter only.





Electronic Shutter:

Shoot with the electronic shutter only.

Hint

- In the following situations, set the [ Shutter Type] to [Auto] or [Electronic Shutter].
 - When shooting with a high-speed shutter in a bright environment such as outside in bright sunlight, the beach, or snowy mountains.
 - When you want to increase the speed of continuous shooting.
- In the following situations, set the [ Shutter Type] to [Auto] or [Mechanical Shutter].
 - When you want to use the flash with a shutter speed faster than 1/100 second.
 - When you are concerned about distortion in the image due to the movement of the subject or the movement of the camera.

Note

- When shooting with the electronic shutter, there may be distortion in the image due to the movement of the subject or the camera itself.
- During shooting with the electronic shutter, band-like light-and-dark shading may appear when shooting under flickering light such as fluorescent light or instantaneous light (such as the flash of another camera).
- In rare cases, the shutter sound may be produced when the power is turned off even if the [ Shutter Type] is set to [Electronic Shutter]. However, this is not a malfunction.
- In the following situations, the mechanical shutter will be activated even if the [ Shutter Type] is set to [Electronic Shutter].
 - When capturing a standard white color for the custom white balance
 - [Face Registration]
- The following functions are unavailable when the [ Shutter Type] is set to [Electronic Shutter].
 -  Long Exposure NR
 - Bulb shooting
- When using an external flash, the highest shutter speed you can set is 1/4000 seconds. However, because this shutter speed uses the electronic shutter, a belt-like contrast may be recorded on the image. If this occurs, set the [ Shutter Type] to [Mechanical Shutter].

Digital Camera
ZV-1

Release w/o Card

Sets whether the shutter can be released when no memory card has been inserted.

1 MENU →  2 (Camera Settings2) → [Release w/o Card] → desired setting.

Menu item details

Enable:

Releases the shutter even if no memory card has been inserted.

Disable:

Does not release the shutter when no memory card has been inserted.



Note

- When no memory card has been inserted, the images shot will not be saved.
- The default setting is [Enable]. It is recommended that you select [Disable] prior to actual shooting.

Digital Camera
ZV-1

SteadyShot (still image)

Sets whether or not to use the SteadyShot function.

1 MENU →  2 (Camera Settings2) → [ SteadyShot] → desired setting.

Menu item details

On:

Uses [ SteadyShot].

Off:

Does not use [ SteadyShot].



We recommend that you set the camera to [Off] when using a tripod.

Related Topic

- [SteadyShot \(movie\)](#)

Long Exposure NR (still image)

When you set the shutter speed to 1/3 second(s) or longer (long exposure shooting), noise reduction is turned on for the duration that the shutter is open. With the function turned on, the grainy noise typical of long exposures is reduced.

1 MENU →  1 (Camera Settings1) → [ Long Exposure NR] → desired setting.

Menu item details





On:

Activates noise reduction for the same duration that the shutter is open. When noise reduction is in progress, a message appears and you cannot take another picture. Select this to prioritize the image quality.

Off:

Does not activate noise reduction. Select this to prioritize the timing of shooting.



Note

- [ Long Exposure NR] is not available when [ Shutter Type] is set to [Electronic Shutter].
- Noise reduction may not be activated even if [ Long Exposure NR] is set to [On] in the following situations:
 - The shooting mode is set to [Sweep Panorama].
 - [Drive Mode] is set to [Cont. Shooting], [Cont. Bracket], or [Self-timer(Cont)].
 - The shooting mode is set to [Scene Selection] and [Sports Action], [Hand-held Twilight] or [Anti Motion Blur] is selected.
 - The ISO sensitivity is set to [Multi Frame NR].
- [ Long Exposure NR] cannot be set to [Off] in the following shooting modes:
 - [Intelligent Auto]
 - [Scene Selection]
- Depending on the shooting conditions, the camera may not perform noise reduction, even if the shutter speed is 1/3 second(s) or longer.

Digital Camera
ZV-1

High ISO NR (still image)

When shooting with high ISO sensitivity, the product reduces noise that becomes more noticeable when the product sensitivity is high.

1 MENU →  1 (Camera Settings1) → [ High ISO NR] → desired setting.

Menu item details

Normal:

Activates high ISO noise reduction normally.





Low:

Activates high ISO noise reduction moderately.

Off:

Does not activate high ISO noise reduction. Select this to prioritize the timing of shooting.

Note

- [ High ISO NR] is fixed to [Normal] in the following shooting modes:
 - [Intelligent Auto]
 - [Scene Selection]
 - [Sweep Panorama]
- When [ File Format] is set to [RAW], this function is not available.
- [ High ISO NR] does not work for RAW images when the [ File Format] is [RAW & JPEG].

Digital Camera
ZV-1

Regist. Faces Priority

Sets whether to focus with higher priority on faces registered using [Face Registration].

1 MENU →  1 (Camera Settings1) → [Regist. Faces Priority] → desired setting.

Menu item details

On:

Focuses with higher priority on faces registered using [Face Registration].

Off:

Focuses without giving higher priority to registered faces.

Hint

- To use the [Regist. Faces Priority] function, set as follows.
 - [Face/Eye Priority in AF] under [Face/Eye AF Set.]: [On]
 - [Subject Detection] under [Face/Eye AF Set.]: [Human]

Related Topic

- [Focusing on eyes \(Face/Eye AF Set.\)](#)
- [Face Registration \(New Registration\)](#)
- [Face Registration \(Order Exchanging\)](#)

Smile Shutter

The camera automatically shoots an image when it detects a smiling face.

1 MENU →  (Camera Settings1) → [Smile Shutter] → desired setting.

Menu item details

Off:

Does not use the [Smile Shutter] function.

On:

The camera automatically shoots an image when it detects a smiling face. You can select [On: Slight Smile], [On: Normal Smile], or [On: Big Smile] for the sensitivity of detection.

Tips for capturing smiles more effectively

- Do not cover the eyes with front hair and keep the eyes narrowed.
- Do not obscure the face by a hat, masks, sunglasses, etc.
- Try to orient the face in front of the product and be as level as possible.
- Give a clear smile with an open mouth. The smile is easier to be detected when the teeth are shown.
- If you press the shutter button during Smile Shutter, the product shoots the image. After shooting, the product returns to Smile Shutter mode.

Note

- You cannot use the [Smile Shutter] function with the following functions:
 - [Sweep Panorama]
 - [Picture Effect]
 - When using the [Focus Magnifier] function.
 - [Scene Selection] is set to [Landscape], [Night Scene], [Sunset], [Hand-held Twilight], [Anti Motion Blur], [Pet], [Gourmet] or [Fireworks].
 - When recording movies.
 - During High Frame Rate shooting
- Up to 8 faces of your subjects can be detected.
- The product may not detect faces at all or may accidentally detect other objects as faces in some conditions.
- If the product cannot detect a smile, adjust the Smile Detection Sensitivity.
- If [Func. of Touch Operation] is set to [Touch Tracking] and you touch a face on the monitor to track while [Smile Shutter] is active, smile detection will only apply to that face.

Face Registration (New Registration)

If you register faces in advance, the product can focus on the registered face as a priority.

- 1 MENU →  (Camera Settings1) → [Face Registration] → [New Registration].
- 2 Align the guide frame with the face to be registered, and press the shutter button.
- 3 When a confirmation message appears, select [Enter].

Note

- Up to eight faces can be registered.
- Shoot the face from the front in a brightly lit place. The face may not be registered correctly if it is obscured by a hat, a mask, sunglasses, etc.

Related Topic

- [Regist. Faces Priority](#)
- [Smile Shutter](#)

Digital Camera
ZV-1

Face Registration (Order Exchanging)

When multiple faces are registered to be given priority, the face registered first will be given priority. You can change the priority order.

- 1 MENU →  1 (Camera Settings1) → [Face Registration] → [Order Exchanging].
 - 2 Select a face to change the order of priority.
 - 3 Select the destination.
-

Related Topic

- [Regist. Faces Priority](#)
- [Smile Shutter](#)

Digital Camera
ZV-1

Face Registration (Delete)

Deletes a registered face.

1 MENU →  (Camera Settings1) → [Face Registration] → [Delete].

If you select [Delete All], you can delete all registered faces.

Note

- Even if you execute [Delete], the data for registered face will remain in the product. To delete the data for registered faces from the product, select [Delete All].

Using flash (sold separately)

In dark environments, use the flash to light up the subject while shooting. Also use the flash to prevent camera-shake. For details on the flash, refer to the instruction manual for the flash.

1 Attach the flash (sold separately) to the product.

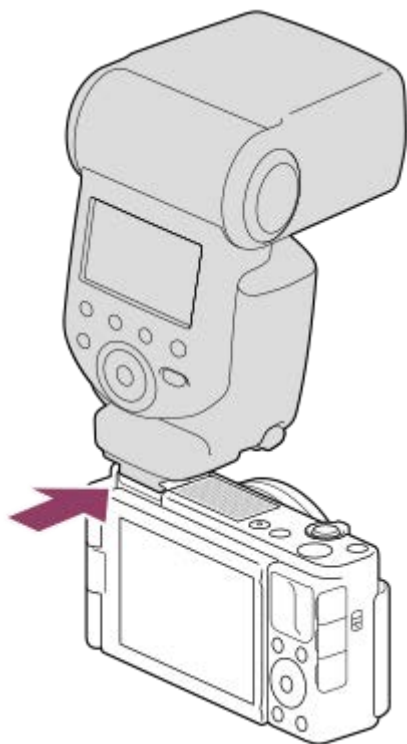

2 Shoot after you have turned on the flash and it is fully charged.

- ⚡ (Flash charge icon) blinking: Charging is in progress
- ⚡ (Flash charge icon) lit up: Charging is finished
- The available flash modes depend on the shooting mode and function.

Note

- You cannot use the flash when recording movies. (You can use an LED light when using a flash (sold separately) with an LED light.)
- Before attaching/removing an accessory such as a flash to/from the Multi Interface Shoe, turn off the product first. When attaching an accessory, make sure that the accessory is fixed securely to the product.
- Do not use the Multi Interface Shoe with a commercially available flash that applies voltage of 250 V or more or has the reverse polarity of the camera. Doing so may cause a malfunction.
- When using flash to shoot pictures of yourself, be careful not to look directly at the light, because the flash will go off at a close distance.
- When shooting with an external flash, light and dark stripes may appear on the image if the shutter speed is set to faster than 1/4000 seconds. If this occurs, Sony recommends shooting in the manual flash mode and setting the flash level to 1/2 or higher.
- For details on compatible accessories for the Multi Interface Shoe, visit the Sony website, or consult your Sony dealer or local authorized Sony service facility.

Related Topic

- [Flash Mode](#)

5-016-934-11(1) Copyright 2020 Sony Corporation

Digital Camera
ZV-1

Flash Mode

You can set the flash mode of the flash (sold separately).

1 MENU →  1 (Camera Settings1) → [Flash Mode] → desired setting.

Menu item details

Flash Off:

The flash does not operate.

Autoflash:

The flash works in dark environments or when shooting towards bright light.

Fill-flash:

The flash works every time you trigger the shutter.

Slow Sync.:

The flash works every time you trigger the shutter. Slow sync shooting allows you to shoot a clear image of both the subject and the background by slowing the shutter speed.

Rear Sync.:

The flash works right before the exposure is completed every time you trigger the shutter. Rear sync shooting allows you to shoot a natural image of the trail of a moving subject such as a moving car or a walking person.

Note

- The default setting depends on the shooting mode.
- Some [Flash Mode] settings are not available, depending on the shooting mode.

Related Topic

- [Using flash \(sold separately\)](#)

Flash Comp.

Adjusts the amount of flash light in a range of -3.0 EV to $+3.0$ EV. Flash compensation changes the amount of flash light only. Exposure compensation changes the amount of flash light along with the change of the shutter speed and aperture.

1 MENU →  1 (Camera Settings1) → [Flash Comp.] → desired setting.

- Selecting higher values (+ side) makes the flash level higher, and lower values (- side) makes the flash level lower.

Note

- [Flash Comp.] does not work when the shooting mode is set to the following modes:
 - [Intelligent Auto]
 - [Sweep Panorama]
 - [Scene Selection]
- The higher flash effect (+ side) may not be visible due to the limited amount of flash light available, if the subject is outside the maximum range of the flash. If the subject is very close, the lower flash effect (- side) may not be visible.

Related Topic

- [Using flash \(sold separately\)](#)

Shooting movies

You can record movies by pressing the MOVIE (Movie) button.

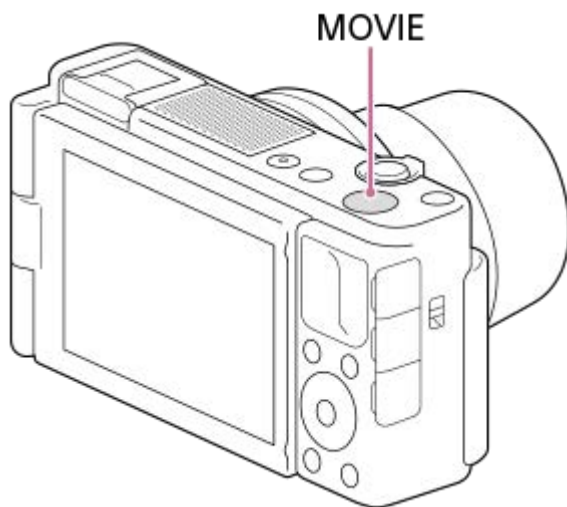

1 Press the MOVIE button to start recording.

- Since the [MOVIE Button] is set to [Always] in the default setting, movie recording can be started from any shooting mode.











2 Press the MOVIE button again to stop recording.

Hint

- You can assign the start/stop movie recording function to a preferred key. MENU →  (Camera Settings2) →  Custom Key → set [MOVIE] to the preferred key.
- When you want to specify the area to be focused on, set the area using [Focus Area].
- To keep the focus on a face, arrange the composition so that the focusing frame and face detection frame overlap, or set the [Focus Area] to [Wide].
- To adjust the shutter speed and aperture value to the desired settings, set the shooting mode to  (Movie) and select the desired exposure mode.
- An icon indicating that data is being written is displayed after shooting. Do not remove the memory card while the icon is displayed.
- The following settings for still image shooting are applied to the movie shooting:
 - White Balance
 - Creative Style
 - Metering Mode
 - Face/Eye Priority in AF
 - Face Priority in Multi Metering
 - D-Range Optimizer
- You can change the settings for ISO sensitivity, exposure compensation, and focus area while shooting movies.
- While shooting movies, the recorded image can be output without the shooting information display by setting [HDMI Info. Display] to [Off].

Note

- The sound of the lens and the product in operation may be recorded during movie recording. The sound of the zoom is particularly likely to be recorded during movie recording if [Zoom Speed] is set to [Fast].
You can set the camera not to record sound by selecting MENU →  (Camera Settings2) → [Audio Recording] → [Off].
- The recording lamp lights up when recording starts.
- The temperature of the camera tends to rise when shooting movies continuously, and you may feel that the camera is warm. This is not a malfunction. Also, [Internal temp. high. Allow it to cool.] may appear. In such cases, turn the power off and cool the camera and wait until the camera is ready to shoot again.
- If  (Overheating warning icon) appears, the temperature of the camera has risen. Turn the power off and cool the camera and wait until the camera is ready to shoot again.
- For the continuous shooting time of a movie recording, refer to “Recordable movie times.” When movie recording is finished, you can record another movie by pressing the MOVIE button again. Recording may stop to protect the product, depending on the temperature of the product or the battery.
- When the shooting mode is set to  (Movie),  (Intelligent Auto) or **HFR** (High Frame Rate), or during movie shooting, you cannot select [Tracking] for [Focus Area].
- In [Program Auto] mode when shooting movies, the aperture value and the shutter speed will be set automatically and cannot be changed. For that reason, the shutter speed may become fast in a bright environment, and the motion of the subject may not be recorded smoothly. By changing the exposure mode and adjusting the aperture value and the shutter speed, the motion of the subject can be recorded smoothly.
- In movie shooting mode, ISO sensitivity can be selected from ISO 125 to ISO 12800. If the ISO value is set to a value smaller than ISO 125, the setting is automatically switched to ISO 125. When you finish recording the movie, the ISO value returns to the original setting.
- When ISO sensitivity is set to [Multi Frame NR], [ISO AUTO] will be set temporarily.
- In movie shooting mode, the following settings cannot be set in [Picture Effect]. When a movie recording starts, [Off] will be set temporarily.
 - Soft Focus
 - HDR Painting
 - Rich-tone Mono.
 - Miniature
 - Watercolor
 - Illustration
- The Face Detection function / Eye Detection function is not available in the following situations.
 - [ File Format] is set to [XAVC S 4K], [ Record Setting] is set to [30p 100M]/[25p 100M] or [30p 60M]/[25p 60M], and [ 4K Output Select] is set to [Memory Card+HDMI]
 - [ File Format] is set to [XAVC S HD], and [ Record Setting] is set to [120p 100M]/[100p 100M] or [120p 60M]/[100p 60M]
- If you point the camera at an extremely strong light source while shooting a movie at low ISO sensitivity, the highlighted area in the image may be recorded as a black area.
- Use PlayMemories Home when importing XAVC S movies and AVCHD movies to a computer.

Related Topic

- [MOVIE Button](#)
- [Movie w/ shutter](#)
- [File Format \(movie\)](#)
- [Recordable movie times](#)
- [Assigning frequently used functions to buttons \(Custom Key\)](#)
- [Focus Area](#)

Digital Camera
ZV-1

Movie w/ shutter

You can start or stop recording movies by pressing the shutter button instead of the MOVIE (Movie) button.

1 MENU →  2 (Camera Settings2) → [Movie w/ shutter] → desired setting.

Menu item details

On:
Enables movie recording using the shutter button when the shooting mode is set to [Movie] or [ Intelligent Auto], or during High Frame Rate shooting.

Off:
Disables movie recording using the shutter button.

Hint

- When [Movie w/ shutter] is set to [On], you can still start or stop recording movies using the MOVIE button.
- When [Movie w/ shutter] is set to [On], you can use the shutter button to start or stop recording movies on an external recording/playback device using [ REC Control].

Related Topic

- [Shooting movies](#)

Movie recording formats

The following movie recording formats are available with this camera.

What is XAVC S?

Records movies in high definition such as 4K by converting them into MP4 movies using the MPEG-4 AVC/H.264 codec. MPEG-4 AVC/H.264 is capable of compressing images with higher efficiency. You can record high-quality images while reducing the amount of data.

XAVC S/AVCHD recording format

XAVC S 4K:

Bit-rate: Approx. 100 Mbps or approx. 60 Mbps

Records movies in 4K resolution (3840×2160).

XAVC S HD:

Bit-rate: Approx. 100 Mbps, approx. 60 Mbps, approx. 50 Mbps, approx. 25 Mbps, or approx. 16 Mbps

Records movies in crisper quality than AVCHD with larger amounts of data.

AVCHD:

Bit-rate: Approx. 24 Mbps (maximum) or approx. 17 Mbps (average)

The AVCHD format has a high degree of compatibility with storage devices other than computers.



- Bit rate is the amount of data processed within a given period of time.

Related Topic

- [File Format \(movie\)](#)
- [Record Setting \(movie\)](#)
- [AVCHD format](#)

File Format (movie)

Selects the movie file format.

1 MENU →  2 (Camera Settings2) → [ File Format] → desired setting.

Menu item details



Parameter	Description	What you can do using PlayMemories Home
XAVC S 4K	Records movies in 4K resolution (3840×2160).	You can save movies on a computer.
XAVC S HD	Records movies in crisper quality than AVCHD with larger amounts of data.	You can save movies on a computer.
AVCHD	The AVCHD format has a high degree of compatibility with storage devices other than computers.	You can save movies on a computer or create an AVCHD media.

Note

- When recording XAVC S 4K or XAVC S HD movies in 120p/100p, the amount of time available for continuous recording is approximately 5 minutes. The remaining time for movie recording is displayed on the monitor. However, when [Auto Power OFF Temp.] is set to [High], you can record movies continuously for over 5 minutes. If you want to record another session of 4K or HD 120p/100p movie shooting, turn off the camera and wait for some time before you start the next session of shooting. Even if the recording time was less than 5 minutes, recording may stop to protect the camera, depending on the temperature of the shooting environment.
- When [ File Format] is set to [AVCHD], the file size of movies is limited to approx. 2 GB. If the movie file size reaches approx. 2 GB during recording, a new movie file will be created automatically.

Record Setting (movie)

Selects the frame rate and bit-rate for movie recording.

1 MENU →  2 (Camera Settings2) → [ Record Setting] → desired setting.

- The higher the bit-rate, the higher the image quality.

Menu item details

When [ File Format] is set to [XAVC S 4K]

 Record Setting	Bit-rate	Description
30p 100M/ 25p 100M	Approx. 100 Mbps	Records movies in 3840×2160 (30p/25p).
30p 60M/ 25p 60M	Approx. 60 Mbps	Records movies in 3840×2160 (30p/25p).
24p 100M *	Approx. 100 Mbps	Records movies in 3840×2160 (24p).
24p 60M *	Approx. 60 Mbps	Records movies in 3840×2160 (24p).

* Only when [NTSC/PAL Selector] is set to NTSC

When [ File Format] is set to [XAVC S HD]

 Record Setting	Bit-rate	Description
60p 50M/50p 50M	Approx. 50 Mbps	Records movies in 1920×1080 (60p/50p).
60p 25M/50p 25M	Approx. 25 Mbps	Records movies in 1920×1080 (60p/50p).
30p 50M/25p 50M	Approx. 50 Mbps	Records movies in 1920×1080 (30p/25p).
30p 16M/25p 16M	Approx. 16 Mbps	Records movies in 1920×1080 (30p/25p).
24p 50M *	Approx. 50 Mbps	Records movies in 1920×1080 (24p).
120p 100M/100p 100M	Approx. 100 Mbps	Records high-speed movies in 1920×1080 (120p/100p). You can record movies in 120 fps or 100 fps. <ul style="list-style-type: none"> • You can create smoother slow-motion movies by using compatible editing devices.



 Record Setting	Bit-rate	Description
120p 60M/100p 60M	Approx. 60 Mbps	Records high-speed movies in 1920×1080 (120p/100p). You can record movies in 120 fps or 100 fps. <ul style="list-style-type: none"> You can create smoother slow-motion movies by using compatible editing devices.

* Only when [NTSC/PAL Selector] is set to NTSC

When [File Format] is set to [AVCHD]

 Record Setting	Bit-rate	Description
60i 24M(FX)/50i 24M(FX)	24 Mbps at maximum	Records movies in 1920×1080 (60i/50i).
60i 17M(FH)/50i 17M(FH)	Approx. 17 Mbps on average	Records movies in 1920×1080 (60i/50i).

Note



- Creating an AVCHD recording disc from movies that were recorded with [60i 24M(FX)]/[50i 24M(FX)] as the [ Record Setting] takes a long time because the image quality of movies is converted. If you want to store movies without converting them, use a Blu-ray Disc.
- [120p]/[100p] cannot be selected for the following settings.
 - [Intelligent Auto]
 - [Scene Selection]
 - [ Intelligent Auto]

Shooting super-slow-motion movies (HFR Settings)

By shooting with a higher frame rate than the recording format, you can record a smooth super-slow-motion movie.

1 MODE (Mode) button → [High Frame Rate] → press the center of the control wheel.

The shooting mode becomes set to [High Frame Rate], and the shooting setting screen appears.

- You can also set the shooting mode by selecting MENU →  1 (Camera Settings1) → [Shoot Mode].
- You can select the desired exposure mode by selecting MENU →  2 (Camera Settings2) → [**HFR** Exposure Mode].

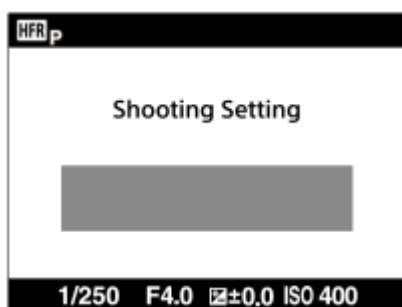

2 MENU → 2 (Camera Settings2) → [**HFR** HFR Settings] and select the desired settings for [**HFR** Record Setting], [**HFR** Frame Rate], [**HFR** Priority Setting], and [**HFR** REC Timing].

3 Point the camera at the subject and adjust settings such as the focus.

- You can also change other settings, such as focus mode, ISO sensitivity, etc.
- The focus becomes locked once the camera enters the shooting standby, even when using the auto focus. If you cannot focus on the intended subject using the auto focus, use the manual focus.

4 Press the center of the control wheel.

The shooting setting screen will close and the camera will switch to the shooting standby.

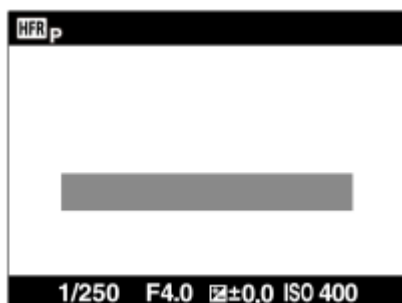

- You cannot adjust the exposure, adjust the focus, operate the zoom, etc. during the shooting standby. If you want to change the shooting settings, press the center of the control wheel again to return to the shooting setting screen.

5 Press the MOVIE (Movie) button.

When [**HFR** REC Timing] is set to [Start Trigger]:

Movie capturing (shooting) starts. When the MOVIE button is pressed again, or when the recordable duration of

time has elapsed, movie capturing ends and the camera starts to record the captured movie to the memory card.

When [HFR REC Timing] is set to [End Trigger] or [End Trigger Half]:

Movie capturing ends and the camera starts to record the captured movie to the memory card.

Menu item details

HFR Record Setting :

Selects the frame rate of the movie from [60p 50M]/[50p 50M], [30p 50M]/[25p 50M], and [24p 50M*].

* Only when [NTSC/PAL Selector] is set to NTSC.

HFR Frame Rate :

Selects the shooting frame rate from [240fps]/[250fps], [480fps]/[500fps], and [960fps]/[1000fps].

HFR Priority Setting :

Select from [Quality Priority] which prioritizes the image quality and [Shoot Time Priority] which prioritizes the duration of time of the movie.

HFR REC Timing :

Selects whether to record for a set amount of time after you press the MOVIE button ([Start Trigger]), or for a set amount of time until you press the MOVIE button ([End Trigger]/[End Trigger Half]).

Frame rate

In super-slow-motion movie shooting, the camera shoots at a faster shutter speed than the number of shooting frames per second. For example, when [HFR Frame Rate] is set to [960fps], the shutter speed per frame will be faster than approx. 1/1000 second in order to shoot 960 frames per second. To maintain this shutter speed, sufficient ambient light is necessary during shooting. If the ambient light is insufficient, the ISO sensitivity will become higher, resulting in more noise.

Shortest shooting distance

The image becomes out of focus when the subject is too close, such as during macro shooting. Shoot from the shortest shooting distance (W side: approximately 5 cm (0.16 ft), T side: approximately 30 cm (0.98 ft) (from the lens)) or further.

Timing of recording

Depending on the [HFR REC Timing] setting, the relationship between when you press the MOVIE button and the recorded section of the movie is as shown below.

[Start Trigger]

Movie capturing (shooting) starts when the MOVIE button is pressed. When the MOVIE button is pressed again, or when the recordable duration of time has elapsed, movie capturing ends and the camera starts to record the captured movie to the memory card.

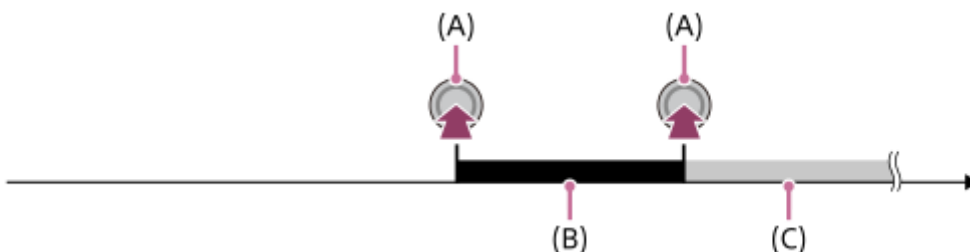

(A): The point when the MOVIE button is pressed

(B): Recorded section

(C): Recording to memory card in progress (You cannot start the next session of shooting.)

[End Trigger]/[End Trigger Half]

Buffering (temporarily capturing a movie on the camera) starts once the camera enters the shooting standby. When the

captured data fills the buffering capacity, old data is overwritten sequentially. When you press the MOVIE button, the camera starts to record a movie of the set duration calculated retroactively from that point on the memory card.

- With [End Trigger], a movie of the maximum possible duration is recorded. With [End Trigger Half], a movie of half the maximum possible duration is recorded. With [End Trigger Half], the time it takes to record to the memory card is also shorter than with [End Trigger].

End Trigger

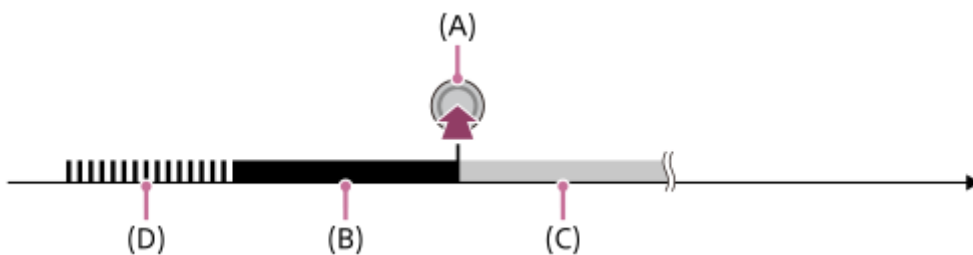

End Trigger Half

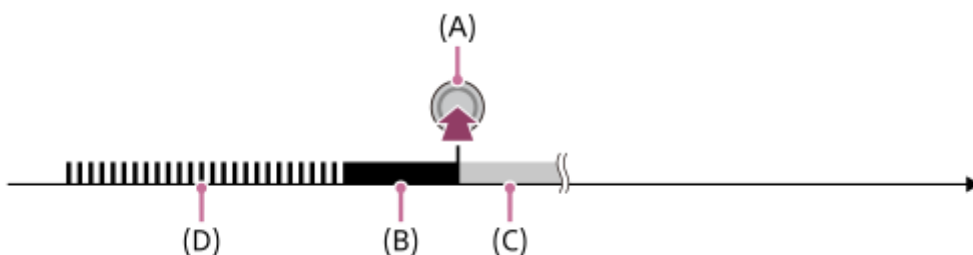

- (A): The point when the MOVIE button is pressed
- (B): Recorded section
- (C): Recording to memory card in progress (You cannot start the next session of shooting.)
- (D): Buffering in progress

To redo shooting

You can cancel recording by selecting [Cancel] on the screen. However, the movie recorded up to the point you cancelled will be saved.

Playback speed

The playback speed will vary as below depending on the assigned [HFR Frame Rate] and [HFR Record Setting].

HFR Frame Rate	HFR Record Setting: 24p 50M*	HFR Record Setting: 30p 50M/25p 50M	HFR Record Setting: 60p 50M/50p 50M
240fps/250fps	10 times slower	8 times slower/10 times slower	4 times slower/5 times slower
480fps/500fps	20 times slower	16 times slower/20 times slower	8 times slower/10 times slower
960fps/1000fps	40 times slower	32 times slower/40 times slower	16 times slower/20 times slower

* Only when [NTSC/PAL Selector] is set to NTSC.

[HFR Priority Setting] and shooting duration

HFR Priority Setting	HFR Frame Rate	Effective pixel number read out from image sensor	Shooting duration
Quality Priority	240fps/250fps	1824×1026	Approx. 2 seconds
Quality Priority	480fps/500fps	1824×616	Approx. 1 seconds
Quality Priority	960fps/1000fps	1244×420	Approx. 1 seconds

HFR Priority Setting	HFR Frame Rate	Effective pixel number read out from image sensor	Shooting duration
Shoot Time Priority	240fps/250fps	1824×616	Approx. 3 seconds
Shoot Time Priority	480fps/500fps	1292×436	Approx. 3 seconds
Shoot Time Priority	960fps/1000fps	912×308	Approx. 3 seconds

Playback time

For example, if you shoot for approx. 4 seconds with [**HFR** Record Setting] set to [24p 50M]*, [**HFR** Frame Rate] set to [960fps], and [**HFR** Priority Setting] set to [Shoot Time Priority], the playback speed will be 40 times slower and the playback time will be approx. 160 seconds (approx. 2 minutes and 40 seconds).

* Only when [NTSC/PAL Selector] is set to NTSC.

Note

- Sound will not be recorded.
- The movie will be recorded in XAVC S HD format.
- It may take time for recording to finish after you press the MOVIE button. Wait until the camera enters the shooting standby to start the next session of shooting.

Related Topic

- [HFR \(High Frame Rate\): Exposure Mode](#)

Capturing still images while recording movies (Dual Rec)

You can capture still images while recording movies without stopping recording. Use Dual Rec when you want to record both movies and still images at the same time.

- 1 Press the **MOVIE** button to start recording the movie.

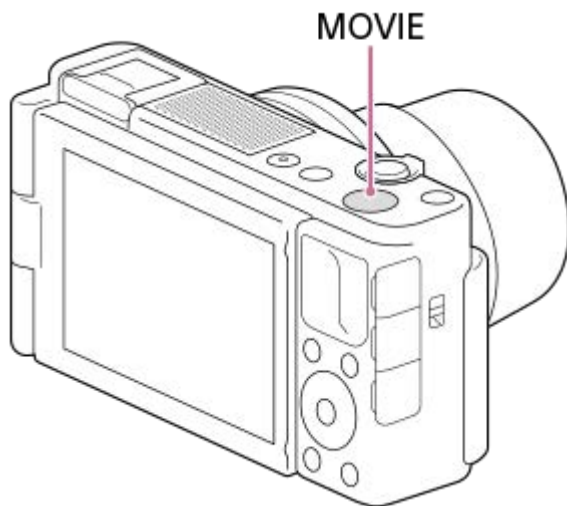

- 2 Press the shutter button to capture a still image.

- If you press the shutter button halfway down, the remaining number of still images you can shoot will be displayed on the screen.
- While shooting still images, the message [CAPTURE] is displayed on the screen.

- 3 Press the **MOVIE** button again to finish recording the movie.

Hint

- The image size or image quality of the still images can be selected from MENU →  (Camera Settings2) → [Img. Size(Dual Rec)]/[Quality(Dual Rec)].

Note

- Dual Rec may be unavailable depending on the recording setting or mode setting.
- When [ Proxy Recording] is set to [On], Dual Rec is unavailable.
- Depending on the memory card you use, it may take a while to record a still image.
- The shutter button sound may be recorded.
- You cannot use the flash during Dual Rec.
- [Soft Skin Effect] is not applied to still images shot using the Dual Rec function.

- Quality(Dual Rec)
- Img. Size(Dual Rec)
- Auto Dual Rec

5-016-934-11(1) Copyright 2020 Sony Corporation

Digital Camera
ZV-1

Quality(Dual Rec)

Selects the quality of still images to be shot while recording movies.

1 MENU →  2 (Camera Settings2) → [Quality(Dual Rec)] → desired setting.

Menu item details

Extra fine/Fine/Standard

Digital Camera
ZV-1

Img. Size(Dual Rec)

Selects the size of still images to be shot while recording movies.



1 MENU →  2 (Camera Settings2) → [Img. Size(Dual Rec)] → desired setting.

Menu item details

L: 17M/M: 7.5M/S: 4.2M

Auto Dual Rec

Sets whether or not to automatically shoot still images when shooting movies. Shoots when impressive compositions, including people, are detected. This function may also record versions of the automatically shot images that have been trimmed into optimal compositions. When a trimmed image is recorded, both the image before trimming and the trimmed image will be recorded.

- 1 **MENU** →  **2 (Camera Settings2)** → **[Auto Dual Rec]** → **desired setting.**
- 2 **Press the MOVIE button to start movie recording.**
 - Still images will be shot automatically. While capturing a still image, the message [CAPTURE] is displayed on the monitor.
- 3 **Press the MOVIE button again to finish movie recording.**
 - To view the movies and still images recorded, press the  (Playback) button.

Menu item details

Off:

Auto Dual Rec is not performed.

On: Shoot. Frequency Low/On: Shoot. Frequency Standard/On: Shoot. Frequency High:

Auto Dual Rec is performed with the specified shooting frequency.

- The positions, orientation, expressions of faces are detected in order to shoot still images with the impressive compositions.

Hint

- If you want to change the size or quality of still images, use **MENU** →  **2 (Camera Settings2)** → **[Img. Size(Dual Rec)]/[Quality(Dual Rec)]**.
- Even when [Auto Dual Rec] is set to On, you can record still images by pressing the shutter button.

Note



- Depending on the recording conditions, still images may not be shot with the optimal timing.
- Auto Dual Rec is unavailable when shooting movies vertically.

Related Topic

- [Capturing still images while recording movies \(Dual Rec\)](#)
- [Quality\(Dual Rec\)](#)
- [Img. Size\(Dual Rec\)](#)

Proxy Recording

Sets whether to simultaneously record low-bit-rate proxy movies when recording XAVC S movies. Since proxy movies are small in file size, they are suitable for transferring to smartphones or uploading to websites.

1 MENU →  2 (Camera Settings2) → [ Proxy Recording] → desired setting.

Menu item details

On :

Proxy movies are simultaneously recorded.



Off :

Proxy movies are not recorded.

Hint

- Proxy movies are recorded in the XAVC S HD format (1280×720) at 9 Mbps. The frame rate of the proxy movie is the same as that of the original movie.
- Proxy movies are not displayed on the playback screen (single-image playback screen or image index screen).  (Proxy) is displayed over movies for which a proxy movie was simultaneously recorded.

Note

- Proxy movies cannot be played back on this camera.
- Proxy recording is not available in the following situations.
 - When [ File Format] is set to [AVCHD]
 - When [ File Format] is set to [XAVC S HD] and [ Record Setting] is set to [120p]/[100p]
- Deleting/protecting movies that have proxy movies removes/protects both the original and proxy movies. You cannot delete/protect only original movies or proxy movies.
- Movies cannot be edited on this camera.

Related Topic

- [Send to Smartphone Func.: Sending Target \(proxy movies\)](#)
- [Movie recording formats](#)
- [Playing back images on the image index screen \(Image Index\)](#)
- [Memory cards that can be used](#)

Digital Camera
ZV-1

Audio Recording

Sets whether to record sounds when shooting movies. Select [Off] to avoid recording the sounds of the lens and the camera operating.

1 MENU →  2 (Camera Settings2) → [Audio Recording] → desired setting.

Menu item details

On:

Records sound (stereo).

Off:

Does not record sound.

Digital Camera
ZV-1

Audio Level Display

Sets whether to display the audio level on the screen.

1 MENU →  2 (Camera Settings2) → [Audio Level Display] → desired setting.

Menu item details

On:

Displays the audio level.

Off:

Does not display the audio level.

Note

- The audio level is not displayed in the following situations:
 - When [Audio Recording] is set to [Off].
 - When DISP (Display Setting) is set to [No Disp. Info.].
 - During High Frame Rate shooting
- The audio level is also displayed while shooting stand-by in movie recording mode.

Digital Camera
ZV-1

Audio Rec Level

You can adjust the audio recording level while checking the level meter.

- 1 MENU →  2 (Camera Settings2) → [Audio Rec Level].
- 2 Select the desired level using the right/left sides of the control wheel.

Menu item details

+:

Turns up the audio recording level.

-:

Turns down the audio recording level.

Reset:

Resets the audio recording level to the default setting.

Hint

- When you record audio movies with loud volumes, set [Audio Rec Level] to a lower sound level. Doing so enables you to record more realistic audio. When you record audio movies with lower volumes, set [Audio Rec Level] to a greater sound level to make the sound easier to hear.
- The [Audio Rec Level] settings are applied for both the internal microphone and the  (microphone) terminal input.

Note

- Regardless of the [Audio Rec Level] settings, the limiter always operates.
- [Audio Rec Level] is available only when the shooting mode is set to movie mode.
- [Audio Rec Level] is unavailable during High Frame Rate shooting.

Wind Noise Reduct.

Sets whether or not to reduce wind noise by cutting the low-range sound of the input audio from the built-in microphone.

1 MENU →  2 (Camera Settings2) → [Wind Noise Reduct.] → desired setting.

Menu item details

On:

Reduces wind noise.

Off:

Does not reduce wind noise.

Hint

- Wind noise may also be reduced by attaching the wind screen (supplied).

Note

- Setting this item to [On] where wind is not blowing sufficiently hard may cause normal sound to be recorded with too low volume.
- When an external microphone (sold separately) is used, [Wind Noise Reduct.] does not function.

Picture Profile

Allows you to change the settings for the color, gradation, etc. For details on "Picture Profile," refer to <https://helpguide.sony.net/di/pp/v1/en/index.html>.

Customizing the picture profile

You can customize the picture quality by adjusting picture profile items such as [Gamma] and [Detail]. When setting these parameters, connect the camera to a TV or monitor, and adjust them while observing the picture on the screen.

- 1 **MENU** →  1 (Camera Settings1) → [Picture Profile] → the profile you want to change.
- 2 **Move to the item index screen by pressing the right side of the control wheel.**
- 3 **Select the item to change using the top/bottom sides of the control wheel.**
- 4 **Select the desired value using the top/bottom sides of the control wheel and press in the center.**

Using the preset of the picture profile

The default settings [PP1] through [PP10] for movies have been set in advance in the camera based on various shooting conditions.

MENU →  1 (Camera Settings1) → [Picture Profile] → desired setting.

PP1:

Example setting using [Movie] gamma.

PP2:

Example setting using [Still] gamma.

PP3:

Example setting of natural color tone using the [ITU709] gamma.

PP4:

Example setting of a color tone faithful to the ITU709 standard.

PP5:

Example setting using [Cine1] gamma.

PP6:

Example setting using [Cine2] gamma.

PP7:

Example setting using [S-Log2] gamma.

PP8:

Example setting using the [S-Log3] gamma and the [S-Gamut3.Cine] under [Color Mode].

PP9:

Example setting using the [S-Log3] gamma and the [S-Gamut3] under [Color Mode].

PP10:

Example setting for recording HDR movies using [HLG2] gamma.

HDR movie recording

The camera can record HDR movies when a gamma from [HLG], [HLG1] to [HLG3] is selected in the picture profile. Picture profile preset [PP10] provides an example setting for HDR recording. Movies recorded using [PP10] can be viewed with a wider range of brightness than usual when played back on a TV supporting Hybrid Log-Gamma (HLG).

This way, even scenes with a wide range of brightness can be recorded and displayed faithfully, without looking under or over-exposed. HLG is used in HDR TV program production, as defined in the international standard Recommendation ITU-R BT.2100.

Items of the picture profile

Black Level

Sets the black level. (-15 to +15)

Gamma

Selects a gamma curve.

Movie: Standard gamma curve for movies

Still: Standard gamma curve for still images

Cine1: Softens the contrast in dark parts and emphasizes gradation in bright parts to produce a relaxed color movie. (equivalent to HG4609G33)

Cine2: Similar to [Cine1] but optimized for editing with up to 100% video signal. (equivalent to HG4600G30)

ITU709: Gamma curve that corresponds to ITU709.

ITU709(800%): Gamma curve for confirming scenes on the assumption of shooting using [S-Log2] or [S-Log3].

S-Log2: Gamma curve for [S-Log2]. This setting is based on the assumption that the picture will be processed after shooting.

S-Log3: Gamma curve for [S-Log3] with more similar features to film. This setting is based on the assumption that the picture will be processed after shooting.

HLG: Gamma curve for HDR recording. Equivalent to the HDR standard Hybrid Log-Gamma, ITU-R BT.2100.

HLG1: Gamma curve for HDR recording. Emphasizes noise reduction. However, shooting is restricted to a narrower dynamic range than with [HLG2] or [HLG3].

HLG2: Gamma curve for HDR recording. Provides a balance of dynamic range and noise reduction.

HLG3: Gamma curve for HDR recording. Wider dynamic range than [HLG2]. However, noise may increase.

- [HLG1], [HLG2], and [HLG3] all apply a gamma curve with the same characteristics, but each offers a different balance between dynamic range and noise reduction. Each has a different maximum video output level, as follows: [HLG1]: approx. 87%, [HLG2]: approx. 95%, [HLG3]: approx. 100%.

Black Gamma

Corrects gamma in low intensity areas.

[Black Gamma] is fixed at "0" and cannot be adjusted when [Gamma] is set to [HLG], [HLG1], [HLG2], or [HLG3].

Range: Selects the correcting range. (Wide / Middle / Narrow)

Level: Sets the correcting level. (-7 (maximum black compression) to +7 (maximum black stretch))

Knee

Sets knee point and slope for video signal compression to prevent over-exposure by limiting signals in high intensity areas of the subject to the dynamic range of your camera.

[Knee] is disabled if [Mode] is set to [Auto] when [Gamma] is set to [Still], [Cine1], [Cine2], [ITU709(800%)], [S-Log2], [S-Log3], [HLG], [HLG1], [HLG2], or [HLG3]. To enable [Knee], set [Mode] to [Manual].

Mode: Selects auto/manual settings.

- Auto: The knee point and slope are set automatically.
- Manual: The knee point and slope are set manually.

Auto Set: Settings when [Auto] is selected for [Mode].

- Max Point: Sets the maximum point of the knee point. (90% to 100%)
- Sensitivity: Sets the sensitivity. (High / Mid / Low)

Manual Set: Settings when [Manual] is selected for [Mode].

- Point: Sets the knee point. (75% to 105%)
- Slope: Sets the knee slope. (-5 (gentle) to +5 (steep))

Color Mode

Sets type and level of colors.

In [Color Mode], only [BT.2020] and [709] are available when [Gamma] is set to [HLG], [HLG1], [HLG2], or [HLG3].

Movie: Suitable colors when [Gamma] is set to [Movie].

Still: Suitable colors when [Gamma] is set to [Still].

Cinema: Suitable colors when [Gamma] is set to [Cine1] or [Cine2].

Pro: Similar color tones to the standard image quality of Sony professional cameras (when combined with ITU709 gamma)

ITU709 Matrix: Colors corresponding to ITU709 standard (when combined with ITU709 gamma)

Black & White: Sets the saturation to zero for shooting in black and white.

S-Gamut: Setting based on the assumption that the pictures will be processed after shooting. Used when [Gamma] is set to [S-Log2].

S-Gamut3.Cine: Setting based on the assumption that the pictures will be processed after shooting. Used when [Gamma] is set to [S-Log3]. This setting allows you to shoot in a color space that can easily be converted for digital cinema.

S-Gamut3: Setting based on the assumption that the pictures will be processed after shooting. Used when [Gamma] is set to [S-Log3]. This setting allows you to shoot in a wide color space.

BT.2020: Standard color tone when [Gamma] is set to [HLG], [HLG1], [HLG2], or [HLG3].

709: Color tone when [Gamma] is set to [HLG], [HLG1], [HLG2], or [HLG3] and movies are recorded with HDTV color (BT.709).

Saturation

Sets the color saturation. (-32 to +32)

Color Phase

Sets the color phase. (-7 to +7)

Color Depth

Sets the color depth for each color phase. This function is more effective for chromatic colors and less effective for achromatic colors. The color looks deeper as you increase the setting value towards the positive side, and lighter as you decrease the value towards the negative side. This function is effective even if you set [Color Mode] to [Black & White].

[R] -7 (light red) to +7 (deep red)

[G] -7 (light green) to +7 (deep green)

[B] -7 (light blue) to +7 (deep blue)

[C] -7 (light cyan) to +7 (deep cyan)

[M] -7 (light magenta) to +7 (deep magenta)

[Y] -7 (light yellow) to +7 (deep yellow)

Detail

Sets items for [Detail].

Level: Sets the [Detail] level. (-7 to +7)

Adjust: The following parameters can be selected manually.

- Mode: Selects auto/manual setting. (Auto (automatic optimization) / Manual (The details are set manually.))
- V/H Balance: Sets the vertical (V) and horizontal (H) balance of DETAIL. (-2 (off to the vertical (V) side) to +2 (off to the horizontal (H) side))
- B/W Balance: Selects the balance of the lower DETAIL (B) and the upper DETAIL (W). (Type1 (off to the lower DETAIL (B) side) to Type5 (off to the upper DETAIL (W) side))
- Limit: Sets the limit level of [Detail]. (0 (Low limit level: likely to be limited) to 7 (High limit level: unlikely to be limited))
- Crisping: Sets the crisping level. (0 (shallow crisping level) to 7 (deep crisping level))
- Hi-Light Detail: Sets the [Detail] level in the high intensity areas. (0 to 4)

To copy the settings to another picture profile number

You can copy the settings of the picture profile to another picture profile number.

MENU →  1 (Camera Settings1) → [Picture Profile] → [Copy].

To reset the picture profile to the default setting

You can reset the picture profile to the default setting. You cannot reset all picture profile settings at once.

MENU →  1 (Camera Settings1) → [Picture Profile] → [Reset].

Note

- Since the parameters are shared for movie and still images, adjust the value when you change the shooting mode.
- If you develop RAW images with shooting settings, the following settings are not reflected:
 - Black Level
 - Black Gamma
 - Knee
 - Color Depth
- When the [ Record Setting] is [120p 100M]/[100p 100M] or [120p 60M]/[100p 60M], [Black Gamma] is fixed at “0” and cannot be adjusted.
- If you change [Gamma], the available ISO value range changes.
- When using S-Log2 or S-Log3 gamma, the noise becomes more noticeable compared to when using other gammas. If the noise still is significant even after processing pictures, it may be improved by shooting with a brighter setting. However, the dynamic range becomes narrower accordingly when you shoot with a brighter setting. We recommend checking the picture in advance by test shooting when using S-Log2 or S-Log3.
- Setting [ITU709(800%)], [S-Log2] or [S-Log3] may cause an error in the white balance custom setup. In this case, perform custom setup with a gamma other than [ITU709(800%)], [S-Log2], or [S-Log3] first, and then reselect [ITU709(800%)], [S-Log2], or [S-Log3] gamma.
- Setting [ITU709(800%)], [S-Log2] or [S-Log3] disables the [Black Level] setting.
- If you set [Slope] to +5 in [Manual Set] under [Knee], [Knee] will be disabled.
- S-Gamut, S-Gamut3.Cine, and S-Gamut3 are color spaces exclusive to Sony. However, this camera's S-Gamut setting does not support the whole S-Gamut color space; it is a setting to achieve a color reproduction equivalent to S-Gamut.

Related Topic

- [Gamma Disp. Assist](#)

Gamma Disp. Assist

Movies with S-Log gamma are assumed to be processed after shooting in order to make use of the wide dynamic range. Movies with the HLG gamma are assumed to be displayed on HDR-compatible monitors. They are therefore displayed in low contrast during shooting, and may be difficult to monitor. However, you can use the [Gamma Disp. Assist] function to reproduce contrast equivalent to that of normal gamma. In addition, [Gamma Disp. Assist] can also be applied when playing back movies on the camera's monitor.

- 1 **MENU** →  (Setup) → [Gamma Disp. Assist].
- 2 **Select the desired setting using the top/bottom sides of the control wheel.**

Menu item details

Assist
OFF **Off:**

Does not apply [Gamma Disp. Assist].

Assist
AUTO **Auto:**

Displays movies with an [S-Log2→709(800%)] effect when the gamma set in [Picture Profile] is [S-Log2], and with an [S-Log3→709(800%)] effect when the gamma is set to [S-Log3]. Displays movies with an [HLG(BT.2020)] effect when the gamma set in [Picture Profile] is [HLG], [HLG1], [HLG2] or [HLG3], and [Color Mode] is set to [BT.2020].

Displays movies with an [HLG(709)] effect when the gamma set in [Picture Profile] is [HLG], [HLG1], [HLG2] or [HLG3], and [Color Mode] is set to [709].

Assist
S-Log2 **S-Log2→709(800%):**

Displays movies with an S-Log2 gamma reproducing contrast equivalent to ITU709 (800%).

Assist
S-Log3 **S-Log3→709(800%):**

Displays movies with an S-Log3 gamma reproducing contrast equivalent to ITU709 (800%).

Assist
HLG 2020 **HLG(BT.2020):**

Displays movies after adjusting the image quality of the monitor to a quality that is almost the same as when movies are displayed on an [HLG(BT.2020)] compatible monitor.

Assist
HLG 709 **HLG(709):**

Displays movies after adjusting the image quality of the monitor to a quality that is almost the same as when movies are displayed on an [HLG(709)] compatible monitor.

Note

- Movies in the XAVC S 4K or XAVC S HD format with the [HLG], [HLG1], [HLG2], or [HLG3] gamma are displayed with an [HLG(BT.2020)] effect or [HLG(709)] effect depending on the movie's gamma value and color mode. In other situations, movies are displayed according to the gamma setting and color mode setting in [Picture Profile].
- [Gamma Disp. Assist] is not applied to movies when displayed on a TV or monitor connected to the camera.



Related Topic

- [Picture Profile](#)

Digital Camera
ZV-1

Auto Slow Shutter (movie)

Sets whether or not to adjust the shutter speed automatically when recording movies if the subject is dark.

1 MENU →  2 (Camera Settings2) → [ Auto Slow Shutter] → desired setting.

Menu item details



On:

Uses Auto Slow Shutter. The shutter speed automatically slows when recording in dark locations. You can reduce noise in the movie by using a slow shutter speed when recording in dark locations.

Off:

Does not use Auto Slow Shutter. The recorded movie will be darker than when [On] is selected, but you can record movies with smoother motion and less object blur.



Note

- [ Auto Slow Shutter] does not function in the following situations:
 - During High Frame Rate shooting
 -  S (Shutter Priority)
 -  M (Manual Exposure)
 - When [ISO] is set to other than [ISO AUTO]

Digital Camera
ZV-1

Initial Focus Mag. (movie)

Sets the initial magnification scale for [Focus Magnifier] in the movie shooting mode.

1 MENU →  (Camera Settings2) → [ Initial Focus Mag.] → **desired setting.**

Menu item details

x1.0:

Displays the image with the same magnification as the shooting screen.

x4.0:



Displays a 4.0-times enlarged image.

Related Topic

- [Focus Magnifier](#)

AF drive speed (movie)

You can switch focusing speed when using autofocus in movie mode.

1 MENU →  2 (Camera Settings2) → [ AF drive speed] → desired setting.

Menu item details

Fast:

Sets the AF drive speed to fast. This mode is suitable for shooting active scenes, such as sports.

Normal:

Sets the AF drive speed to normal.

Slow:



Sets the AF drive speed to slow. With this mode, the focus switches smoothly when the subject to be focused is changed.

Note

- When [ Record Setting] is set to [120p]/[100p], [ AF drive speed] cannot be used.

AF Tracking Sens. (movie)

You can set the AF sensitivity in movie mode.

1 MENU →  2 (Camera Settings2) →  AF Tracking Sens.] → desired setting.

Menu item details

Responsive:

Sets the AF sensitivity to high. This mode is useful when recording movies in which the subject is moving quickly.



Standard:



Sets the AF sensitivity to normal. This mode is useful when there are obstacles in front of the subject or in crowded places.

Note

- When  Record Setting] is set to [120p]/[100p],  AF Tracking Sens.] cannot be used.

SteadyShot (movie)

Sets [ SteadyShot] effect when shooting movies. If you set the [ SteadyShot] effect to [Off] when using a tripod (sold separately), a natural image is produced.

1 MENU →  2 (Camera Settings2) → [ SteadyShot] → desired setting.

Menu item details

Active:

Provides a more powerful SteadyShot effect.

Standard:

Reduces camera shake under stable movie shooting conditions.

Off:

Does not use [ SteadyShot].

Note

- If you change the setting for [ SteadyShot], the angle of view will change.

Related Topic

- [SteadyShot \(still image\)](#)

Digital Camera
ZV-1

TC/UB Settings

The time code (TC) and the user bit (UB) information can be recorded as data attached to movies.

- 1 MENU →  (Setup) → [TC/UB Settings] → setting value you want to change.

Menu item details

TC/UB Disp. Setting:

Sets the display for the counter, time code, and user bit.

TC Preset:

Sets the time code.

UB Preset:

Sets the user bit.

TC Format:

Sets the recording method for the time code. (Only when [NTSC/PAL Selector] is set to NTSC.)

TC Run:

Sets the count up format for the time code.

TC Make:

Sets the recording format for the time code on the recording medium.

UB Time Rec:

Sets whether or not to record the time as a user bit.



How to set the time code (TC Preset)

1. MENU →  (Setup) → [TC/UB Settings] → [TC Preset].
2. Press the top/bottom side of the control wheel, and select the first two digits.
 - The time code can be set between the following range.
When [60i] is selected: 00:00:00:00 to 23:59:59:29
 - * When [24p] is selected, you can select the last two digits of the time code in multiples of four from 0 to 23 frames.
When [50i] is selected: 00:00:00:00 to 23:59:59:24
3. Set the other digits following the same procedure as in step 2, then press in the center of the control wheel.

Note

- When you rotate the monitor to shoot a self-portrait, the time code and user bit will not be displayed.



How to reset the time code

1. MENU →  (Setup) → [TC/UB Settings] → [TC Preset].
 2. Press the  (Delete) button to reset the time code (00:00:00:00).
- You can also reset the time code (00:00:00:00) using the RMT-VP1K remote commander (sold separately).

How to set the user bit (UB Preset)

1. MENU →  (Setup) → [TC/UB Settings] → [UB Preset].
2. Press the top/bottom side of the control wheel, and select the first two digits.
3. Set the other digits following the same procedure as in step 2, then press in the center of the control wheel.

How to reset the user bit

1. MENU →  (Setup) → [TC/UB Settings] → [UB Preset].
2. Press the  (Delete) button to reset the user bit (00 00 00 00).

How to select the recording method for the time code (TC Format ^{*1})

1. MENU →  (Setup) → [TC/UB Settings] → [TC Format].

DF:

Records the time code in Drop Frame^{*2} format.

NDF:

Records the time code in Non-Drop Frame format.

*1 Only when [NTSC/PAL Selector] is set to NTSC.

*2 The time code is based on 30 frames per second. However, a gap between the actual time and the time code will occur during extended periods of recording as the frame frequency of the NTSC image signal is approximately 29.97 frames per second. Drop frame corrects this gap to make the time code and actual time equal. In drop frame, the first 2 frame numbers are removed every minute except for every tenth minute. The time code without this correction is called non-drop frame.

- The setting is fixed to [NDF] when recording in 4K/24p or 1080/24p.

How to select the count up format for the time code (TC Run)

1. MENU →  (Setup) → [TC/UB Settings] → [TC Run].

Rec Run:

Sets the stepping mode for the time code to advance only while recording. The time code is recorded sequentially from the last time code of the previous recording.

Free Run:

Sets the stepping mode for the time code to advance anytime, regardless of the camera operation.

- The time code may not be recorded sequentially in the following situations even when the time code advances in [Rec Run] mode.
 - When the recording format is changed.
 - When the recording medium is removed.

How to select how the time code is recorded (TC Make)

1. MENU →  (Setup) → [TC/UB Settings] → [TC Make].

Preset:





Records the newly set time code on the recording medium.

Regenerate:

Reads the last time code for the previous recording from the recording medium and records the new time code consecutively from the last time code. The time code advances in [Rec Run] mode regardless of the [TC Run] setting.

TC/UB Disp. Switch

Allows you to display the time code (TC) and user bit (UB) of a movie by pressing the key to which [TC/UB Disp. Switch] function has been assigned.

- 1 MENU →  2 (Camera Settings2) → [ Custom Key], [ Custom Key], or [ Custom Key] → assign the [TC/UB Disp. Switch] function to the desired key.
- 2 Press the key to which [TC/UB Disp. Switch] is assigned.
 - Each time you press the key, the monitor display will switch from the movie recording time counter → time code (TC) → user bit (UB), in that order.

Note

- When the monitor is flipped while in a shooting mode, such as during self-portrait shooting, TC/UB information is not displayed. In the playback mode, TC/UB information is displayed even when the monitor is flipped.

Digital Camera
ZV-1

MOVIE Button

Sets whether or not to activate the MOVIE (Movie) button.

1 MENU →  2 (Camera Settings2) → [MOVIE Button] → desired setting.

Menu item details

Always:



Starts movie recording when you press the MOVIE button in any mode. (except when the shooting mode is set to **HFR** (High Frame Rate).)

Movie Mode Only:

Starts movie recording when you press the MOVIE button only if the shooting mode is set to [Movie] or [ Intelligent Auto].

Marker Display (movie)

Sets whether or not to display markers set using [ Marker Settings] on the monitor while shooting movies.

1 MENU →  2 (Camera Settings2) → [ Marker Display] → **desired setting.**

Menu item details

On:

Markers are displayed. The markers are not recorded.

Off:

No marker is displayed.

Note

- The markers are displayed during movie shooting standby, or while recording movies.
- You cannot display markers when using [Focus Magnifier].
- The markers are displayed on the monitor. (You cannot output the markers.)



Related Topic

- [Marker Settings \(movie\)](#)

Digital Camera
ZV-1

Marker Settings (movie)

Sets the markers to be displayed while shooting movies.

1 MENU →  2 (Camera Settings2) → [ Marker Settings] → desired setting.

Menu item details

Center:

Sets whether or not to display the center marker in the center of the shooting screen.

[Off]/[On]

Aspect:

Sets the aspect marker display.

[Off]/[4:3]/[13:9]/[14:9]/[15:9]/[1.66:1]/[1.85:1]/[2.35:1]

Safety Zone:

Sets the safety zone display. This becomes the standard range that can be received by a general household TV.

[Off]/[80%]/[90%]

Guideframe:

Sets whether or not to display the guide frame. You can verify whether the subject is level or perpendicular to the ground.

[Off]/[On]



Hint

- You can display several markers at the same time.
- Place the subject on the cross point of the [Guideframe] to make a balanced composition.

Digital Camera
ZV-1

4K Output Select (movie)

You can set how to record movies and perform HDMI output when your camera is connected to 4K-compatible external recording/playback devices, etc.

- 1 Set the shooting mode to [Movie] or [ Intelligent Auto].
- 2 Connect the camera to the desired device via an HDMI cable.
- 3 MENU →  (Setup) → [ 4K Output Select] → desired setting.

Menu item details

Memory Card+HDMI:

Simultaneously outputs to the external recording/playback device and records on the camera's memory card.

HDMI Only(30p):

Outputs a 4K movie in 30p to the external recording/playback device without recording on the camera's memory card.

HDMI Only(24p):



Outputs a 4K movie in 24p to the external recording/playback device without recording on the camera's memory card.

HDMI Only(25p) *:

Outputs a 4K movie in 25p to the external recording/playback device without recording on the camera's memory card.

* Only when [NTSC/PAL Selector] is set to PAL.

Note

- This item can be set only when the camera is in movie mode and connected to a 4K-compatible device.
- When [HDMI Only(30p)], [HDMI Only(24p)] or [HDMI Only(25p)] is set, [HDMI Info. Display] will temporarily be set to [Off].
- When [HDMI Only(30p)], [HDMI Only(24p)] or [HDMI Only(25p)] is set, the counter does not move forward (the actual recording time is not counted) while the movie is being recorded on an external recording/playback device.
- When shooting 4K movies using the setting [Memory Card+HDMI], the movies will not be output to a device connected by HDMI cable if you simultaneously record a proxy movie. If you want to perform HDMI output, set [ Proxy Recording] to [Off]. (In this case, if you set [ Record Setting] to other values except [24p], the image will not be displayed on the screen of the camera).
- When [ File Format] is set to [XAVC S 4K] and the camera is connected via HDMI, the following functions are partially restricted.
 - [Face/Eye Priority in AF]
 - [Face Priority in Multi Metering]
 - Tracking function

Related Topic

- [HDMI Settings: REC Control \(movie\)](#)
- [File Format \(movie\)](#)
- [Record Setting \(movie\)](#)
- [HDMI Settings: HDMI Info. Display](#)

Digital Camera
ZV-1

REC Lamp

You can choose whether or not the recording lamp lights up during recording.

1 MENU →  2 (Camera Settings2) → [REC Lamp] → desired setting.

Menu item details

On:

The recording lamp lights up during recording.

Off:

The recording lamp does not light up during recording.

Hint

- Set [REC Lamp] to [Off] if the light of the recording lamp reflected by an object, such as glass, is captured by the camera.

Playing back still images

Plays back the recorded images.

- 1 Press the  (Playback) button to switch to the playback mode.
- 2 Select the image with the control wheel.
 - Images shot with continuous shooting or interval shooting are displayed as one group. To play back the images in the group, press the center of the control wheel.

Hint

- The product creates an image database file on a memory card to record and play back images. An image that is not registered in the image database file may not be played back correctly. To play back images shot using other devices, register those images to the image database file using MENU →  (Setup) → [Recover Image DB].
- If you play back the images right after continuous shooting, the monitor may display an icon indicating that data is being written/the number of images left to write. During writing, some functions are not available.
- You can also enlarge an image by double-tapping the monitor. In addition, you can drag and move the magnified position on the monitor. Set [Touch Operation] to [On] beforehand.

Related Topic



- [Recover Image DB](#)
- [Display as Group](#)

Enlarging an image being played back (Enlarge Image)

Enlarges the image being played back. Use this function to check the focus of the image, etc.

- 1 Display the image you want to enlarge, and slide the W/T (zoom) lever to the T side.**
 - Slide the W/T (zoom) lever to the W side to adjust the zoom scale.
 - The view will zoom in on the part of the image where the camera focused during shooting. If the focus location information cannot be obtained, the camera will zoom in on the center of the image.
- 2 Select the portion you want to enlarge by pressing the top/bottom/right/left sides of the control wheel.**
- 3 Press the MENU button or the center of the control wheel to exit the playback zoom.**

Hint

- You can also enlarge an image being played back using MENU.
- You can change the initial magnification and initial position of enlarged images by selecting MENU →  (Playback) → [ Enlarge Initial Mag.] or [ Enlarge Initial Position].
- You can also enlarge an image by double-tapping the monitor. In addition, you can drag and move the magnified position on the monitor. Set [Touch Operation] to [On] beforehand.

Note

- You cannot enlarge movies.

Related Topic

- [Touch Operation](#)
- [Enlarge Initial Mag.](#)
- [Enlarge Initial Position](#)

Rotating recorded images automatically (Display Rotation)

Selects the orientation when playing back recorded images.

1 MENU →  (Playback) → [Display Rotation] → desired setting.

Menu item details

Auto:

When you rotate the camera, the displayed image rotates automatically by detecting the orientation of the camera.

Manual:

Images shot vertically are displayed vertically. If you have set the image orientation using the [Rotate] function, the image will be displayed accordingly.

Off:

Images are always displayed horizontally.

Note

- Movies shot vertically are played back horizontally on the screen or the finder of the camera during movie playback.

Related Topic

- [Rotating an image \(Rotate\)](#)

Rotating an image (Rotate)

Rotates a recorded image counter-clockwise.

1 Display the image to be rotated, then select MENU →  (Playback) → [Rotate].

2 Press the center of the control wheel.

The image is rotated counter-clockwise. The image rotates as you press the center.
If you rotate the image once, the image remains rotated even after the product is turned off.

Note

- Even if you rotate a movie file, it will be played back horizontally on the monitor of the camera.
- You may not be able to rotate images shot using other products.
- When viewing rotated images on a computer, the images may be displayed in their original orientation depending on the software.

Playing back panoramic images

The product automatically scrolls a panoramic image from end to end.

- 1 Press the  (Playback) button to switch to playback mode.
- 2 Select the panoramic image to be played back using the control wheel and press the center to start playback.



- To pause playback, press the center again.
- To scroll panoramic images manually, press the top/bottom/right/left during pause.
- To return to the display of the entire image, press the MENU button.

Note

- Panoramic images shot using other products may be displayed in a different size from the actual size, or may not scroll correctly.

Enlarge Initial Mag.

Sets the initial magnification scale when playing back enlarged images.

1 MENU →  (Playback) → [ Enlarge Initial Mag.] → desired setting.

Menu item details

Standard. Mag.:

Displays an image with the standard magnification.

Previous Mag.:

Displays an image with the previous magnification. The previous magnification is stored even after exiting the playback zoom mode.

Related Topic

- [Enlarging an image being played back \(Enlarge Image\)](#)
- [Enlarge Initial Position](#)

Enlarge Initial Position

Sets the initial position when enlarging an image in playback.

1 MENU →  (Playback) → [ Enlarge Initial Position] → desired setting.

Menu item details

Focused Position:

Enlarges the image from the point of focus during shooting.

Center:

Enlarges the image from the center of the screen.

Related Topic

- [Enlarging an image being played back \(Enlarge Image\)](#)
- [Enlarge Initial Mag.](#)

Digital Camera
ZV-1















Playing back movies

Plays back the recorded movies.

- 1 Press the  (playback) button to switch to playback mode.
- 2 Select the movie to be played back using the control wheel and press the center of the control wheel to start playback.

Available operations during movie playback

You can perform slow playback and sound volume adjustment, etc. by pressing the down side of the control wheel.

-  : Playback
-  : Pause
-  : Fast-forward
-  : Fast-rewind
-  : Forward slow playback
-  : Reverse slow playback
-  : Next movie file
-  : Previous movie file
-  : Displays the next frame
-  : Displays the previous frame
-  : Motion Shot Video (Shows the tracking of a subject in motion.)
-  : Photo Capture
-  : Sound volume adjustment
-  : Closes the operation panel

Hint

- "Forward slow playback," "Reverse slow playback," "Displays the next frame" and "Displays the previous frame" are available during pause.
- Movie files recorded using other products may not be playable on this camera.

Note

- Even if you shoot the movie vertically, the movie will be displayed horizontally on the monitor of the camera.



Related Topic

- [Switching between still images and movies \(View Mode\)](#)

Motion Shot Video

You can see the tracking of the subject's motion in high-speed, like a stroboscopic image.

1 Press the bottom side of the control wheel during movie playback, then select  (Motion Shot Video).

- To exit [Motion Shot Video] playback, select .
- If you fail to make the trail, you can adjust the interval of the image tracking using .

Hint

- You can also change the interval of the image tracking using MENU →  (Playback) → [Motion Interval ADJ].

Note

- You cannot save the images made with [Motion Shot Video] as a movie file.
- If the motion of the subject is too slow or the subject does not move enough, the product may fail to create the image.

Related Topic

- [Motion Interval ADJ](#)

Digital Camera
ZV-1

Motion Interval ADJ

You can adjust the interval of the tracking of the subject's motion.

1 MENU →  (Playback) → [Motion Interval ADJ] → desired setting.

Related Topic

- [Motion Shot Video](#)

Digital Camera
ZV-1

Volume Settings

Sets the sound volume for movie playback.



1 MENU →  (Setup) → [Volume Settings] → desired setting.

Adjusting the volume during playback

Press the bottom side of the control wheel while playing back movies to display the operation panel, then adjust the volume. You can adjust the volume while listening to the actual sound.

Photo Capture

Captures a chosen scene in a movie to save as a still image. First shoot a movie, then pause the movie during playback to capture decisive moments that tend to be missed when shooting still images, and save them as still images.

- 1 Display the movie that you want to capture as a still image.**
 - 2 MENU →  (Playback) → [Photo Capture].**
 - 3 Play back the movie and pause it.**
 - 4 Find the desired scene using forward slow playback, reverse slow playback, displays the next frame, and displays the previous frame, and then stop the movie.**
 - 5 Press  (Photo Capture) to capture the chosen scene.**
The scene is saved as a still image.
-

Related Topic

- [Shooting movies](#)
- [Playing back movies](#)

Playing back images on the image index screen (Image Index)

You can display multiple images at the same time in playback mode.

- 1 Slide the W/T (zoom) lever to the W side while the image is being played back.
- 2 Select the image by pressing the top/bottom/right/left sides of the control wheel or turning the control wheel.

To change the number of images to be displayed

MENU →  (Playback) → [Image Index] → desired setting.

Menu item details

9 Images/25 Images

To return to single-image playback

Select the desired image and press the center of the control wheel.

To display a desired image quickly

Select the bar on the left of the image index screen using the control wheel, then press the top/bottom sides of the control wheel. While the bar is being selected, you can display the calendar screen or folder selection screen by pressing the center. In addition, you can switch View Mode by selecting an icon.

Related Topic

- [Switching between still images and movies \(View Mode\)](#)

Switching between still images and movies (View Mode)

Sets the View Mode (image display method).

1 MENU →  (Playback) → [View Mode] → desired setting.

Menu item details

Date View:

Displays the images by date.

Folder View(Still):

Displays only still images.

AVCHD View:

Displays only AVCHD-format movies.

XAVC S HD View:

Displays only XAVC S HD-format movies.

XAVC S 4K View:

Displays only XAVC S 4K-format movies.

Display as Group

Sets whether or not to display continuously shot images or images shot using interval shooting as a group.

- 1 MENU →  (Playback) → [Display as Group] → desired setting.

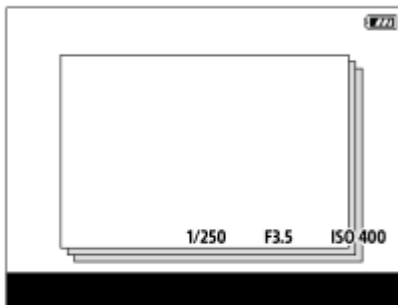

Menu item details

On:



Displays images as a group.

Select a group and press the center of the control wheel to play back images in the group.

Off:

Does not display images as a group.

Hint

- The following images are grouped.
 - Images shot with [Drive Mode] set to [Cont. Shooting] (One sequence of images shot continuously by holding down the shutter button during continuous shooting becomes one group.)
 - Images shot with [ Interval Shoot Func.] (Images shot during one session of interval shooting become one group.)
- On the image index screen, the  (Display as Group) icon is displayed over the group.

Note

- Images can be grouped and displayed only when [View Mode] is set to [Date View]. When it is not set to [Date View], images cannot be grouped and displayed, even if [Display as Group] is set to [On].
- If you delete the group, all the images in the group will be deleted.

Related Topic



- [Cont. Shooting](#)
- [Interval Shoot Func.](#)

Digital Camera
ZV-1



Cont. PB for Interval

Continuously plays back images shot using interval shooting.

You can create movies from still images produced by interval shooting using the computer software Imaging Edge (Viewer). You cannot create movies from the still images on the camera.

- 1 MENU →  (Playback) → [Cont. PB for  Interval].
- 2 Select the image group that you want to play back, and then press the center of the control wheel.

Hint

- On the playback screen, you can start continuous playback by pressing the down button while displaying an image in the group.
- You can resume play or pause by pressing the down button during playback.
- You can change the playback speed by turning the control wheel during playback. You can also change the playback speed by selecting MENU →  (Playback) → [PB Speed for  Interval].
- You can continuously play back images shot with continuous shooting as well.

Related Topic

- [Interval Shoot Func.](#)
- [PB Speed for Interval](#)
- [Introduction to computer software \(PlayMemories Home/Imaging Edge\)](#)

Digital Camera
ZV-1

PB Speed for Interval

Sets the playback speed for still images during [Cont. PB for  Interval].

1 MENU →  (Playback) → [PB Speed for  Interval] → desired setting.

Hint

- You can also change the playback speed by turning the control wheel during [Cont. PB for  Interval].

Related Topic

- [Cont. PB for Interval](#)

Playing back images using slideshow (Slide Show)

Automatically plays back images continuously.

1 MENU →  (Playback) → [Slide Show] → desired setting.

2 Select [Enter].

Menu item details

Repeat:

Select [On], in which images are played back in a continuous loop, or [Off], in which the product exits the slideshow when all the images are played back once.

Interval:

Select the display interval for images from among [1 Sec], [3 Sec], [5 Sec], [10 Sec] or [30 Sec].

To quit the slideshow in the middle of playback

Press the MENU button to quit the slideshow. You cannot pause the slideshow.

Hint

- During playback, you can display the next/previous image by pressing the right/left side of the control wheel.
- You can activate a slideshow only when [View Mode] is set to [Date View] or [Folder View(Still)].

Beauty Effect

Allows you to apply the Beauty Effect to retouch the still image of a person and make it look better, for example, by retouching it for smoother skin, larger eyes, and whiter teeth. You can set the effects from level 1 to level 5. An image on which the Beauty Effect is used is saved as a new file. The original image is retained as it is.

- 1 MENU →  (Playback) → [Beauty Effect].
- 2 Select the face for which you want to use the Beauty Effect.
- 3 Select the desired effect, and adjust the retouching level using the control wheel.

(Skin Toning):

Adjusts the skin color as you like.

1. Select the base skin color using up/down, and then press the center.
2. Adjust the color tone using up/down.

(Skin Smoothing):

Removes age spots and wrinkles from the skin.

Adjust the effect level using up/down.

(Shine Removal):

Reduces the look of oily skin. Adjusts the skin color as you like.

Adjust the effect level using up/down.

(Eye Widening):

Enlarges the eyes of the subject. Adjust the size of the eyes using up/down.

(Teeth Whitening):

Whiten the teeth of the subject. You may not be able to whiten the teeth in some images.

Adjust the whiteness of the teeth using up/down.

To apply two or more effects consecutively using [Beauty Effect], first apply one effect to the image, and then select another effect using left/right.

Note

- You cannot use [Beauty Effect] for the following images:
 - Panoramic images
 - Movies
 - RAW images
- You cannot use the Beauty Effect on an extremely small facial image.
- To use the Beauty Effect on two or more faces, select the same image again after the effect has been applied once, and then use the effect on another face.
- The [Beauty Effect] may not work properly for some images.

Protecting images (Protect)

Protects recorded images against accidental erasure. The  (Protect) mark is displayed on protected images.

1 MENU →  (Playback) → [Protect] → desired setting.

Menu item details

Multiple Img.:

Applies the protection of the selected multiple images.

(1) Select the image to be protected, then press the center of the control wheel. A  (check) mark is displayed in the check box. To cancel the selection, press the center again to clear the check box.

(2) To protect other images, repeat step (1).

(3) MENU → [OK].

All in this Folder:

Protects all images in the selected folder.

All with this date:

Protects all images taken on the selected date.

Cancel All in this Folder:

Cancels the protection of all images in the selected folder.

Cancel All with this date:

Cancels the protection of all images taken on the selected date.



All Images in This Group:

Protects all the images in the selected group.

Cancel All in This Group:

Cancels the protection of all the images in the selected group.

Hint

- If you assign [Protect] to the key of your choice using MENU →  (Camera Settings2) → [ Custom Key], you can protect images or cancel protection by simply pressing the key.
- If you select a group in [Multiple Img.], all the images in the group will be protected. To select and protect particular images within the group, execute [Multiple Img.] while displaying the images within the group.

Note

- The menu items that can be selected vary according to the [View Mode] setting and the selected content.

Rating

You can assign ratings to recorded images on a scale of the number of stars (★ - ★★★) to make it easier to find images.

- 1 MENU →  (Playback) → [Rating].**
The image rating selection screen will appear.
- 2 Press the left/right sides of the control wheel to display an image to which you want to assign a rating, and then press the center.**
- 3 Select the level of ★ (Rating) by pressing the left/right side of the control wheel, and then press the center.**
- 4 Press the MENU button to exit the rating setting screen.**

Hint

- You can also assign ratings when playing back images by using the custom key. Assign [Rating] to the desired key using [ Custom Key] beforehand, and then press the custom key while playing back an image to which you want to assign a rating. The level of ★ (Rating) changes each time you press the custom key.

Note

- You can assign ratings to still images only.



Related Topic

- [Assigning frequently used functions to buttons \(Custom Key\)](#)
- [Rating Set\(Custom Key\)](#)

Digital Camera
ZV-1

Rating Set(Custom Key)

Sets the available number of stars (★) when rating images with the key to which you have assigned [Rating] using [ Custom Key].

- 1 MENU →  (Playback) → [Rating Set(Custom Key)].
 - 2 Add a  (check) mark to the level of ★ (rating) that you want to activate.
You can select the checked number when setting [Rating] using the custom key.
-

Related Topic

- [Rating](#)
- [Assigning frequently used functions to buttons \(Custom Key\)](#)

Specifying images to be printed (Specify Printing)

You can specify in advance on the memory card which still images you want to print out later. The **DPOF** (print order) icon will appear on the specified images. DPOF refers to “Digital Print Order Format.” DPOF setting will be retained after the image is printed. We recommend that you cancel this setting after printing.

1 MENU →  (Playback) → [Specify Printing] → desired setting.

Menu item details

Multiple Img.:

Selects images to order printing.

(1) Select an image and press the center of the control wheel. A  (check) mark is displayed in the check box. To cancel the selection, press the center again and clear the check box.

(2) Repeat step (1) to print other images. To select all the images from a certain date or in a certain folder, select the check box for the date or folder.

(3) MENU → [OK].

Cancel All:

Clears all DPOF marks.

Print Setting:

Sets whether to print the date on images registered with DPOF marks.

- The position or size of the date (inside or outside of the image) may differ depending on the printer.

Note

- You cannot add the DPOF mark to the following files:
 - RAW images
- The number of copies cannot be specified.
- Some printers do not support the date print function.

Deleting a displayed image

You can delete an image displayed. Once you have deleted an image, you cannot restore it. Confirm the image to be deleted beforehand.

- 1 Display the image you want to delete.
- 2 Press the  (Delete) button.
- 3 Select [Delete] using the control wheel.

Note

- The protected images cannot be deleted.

Related Topic

- [Deleting multiple selected images \(Delete\)](#)

Deleting multiple selected images (Delete)

You can delete multiple selected images. Once you have deleted an image, you cannot restore it. Confirm the image to be deleted beforehand.

- 1 MENU →  (Playback) → [Delete] → desired setting.

Menu item details

Multiple Img.:

Deletes the selected images.

(1) Select the images to be deleted, then press the center of the control wheel. A  (check) mark is displayed in the check box. To cancel the selection, press the center again to clear the check box.

(2) To delete other images, repeat step (1).

(3) MENU → [OK].

All in this Folder:

Deletes all images in the selected folder.

All with this date:

Deletes all images taken on the selected date.

All Other Than This Img.:

Deletes all images in the group except the selection.

All Images in This Group:

Deletes all images in the selected group.

Hint

- Perform [Format] to delete all images, including protected images.
- To display the desired folder or date, select the desired folder or date during playback by performing the following procedure:
 (Image Index) lever → select the bar on the left using the control wheel → select the desired folder or date using the top/bottom sides of the control wheel.
- If you select a group in [Multiple Img.], all the images in the group will be deleted. To select and delete particular images within the group, execute [Multiple Img.] while displaying the images within the group.

Note

- The protected images cannot be deleted.
- The menu items that can be selected vary according to the [View Mode] setting and the selected content.

Related Topic

- [Display as Group](#)
- [Deleting a displayed image](#)
- [Format](#)

Digital Camera
ZV-1

Delete confirm.

You can set whether [Delete] or [Cancel] is selected as a default on the delete confirmation screen.

1 MENU →  (Setup) → [Delete confirm.] → desired setting.

Menu item details

"Delete" first:

[Delete] is selected as the default setting.

"Cancel" first:

[Cancel] is selected as the default setting.

Viewing images on a TV using an HDMI cable

To view images stored on this product using a TV, an HDMI cable (sold separately) and an HD TV equipped with an HDMI jack are required.

- 1 Turn off both this product and the TV.
- 2 Connect the HDMI micro terminal of this product to the HDMI jack of the TV using an HDMI cable (sold separately).

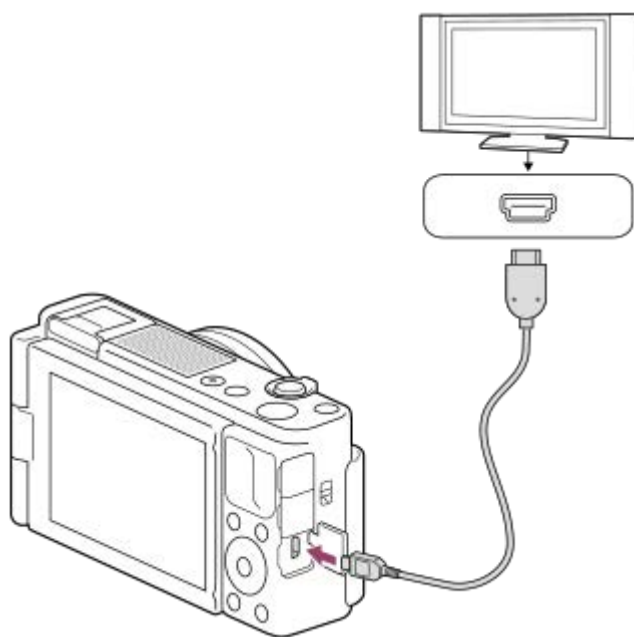

- 3 Turn on the TV and switch the input.
- 4 Turn on this product.
Images shot with the product appear on the TV screen.
- 5 Select an image using the right/left sides of the control wheel.
 - The monitor of this camera is not lit up on the playback screen.
 - If the playback screen is not displayed, press the  (Playback) button.

“BRAVIA” Sync

By connecting this product to a TV that supports “BRAVIA” Sync using an HDMI cable (sold separately), you can operate this product’s playback functions with the TV remote control.





1. After performing the steps above to connect this camera to a TV, select MENU →  (Setup) → [HDMI Settings] → [CTRL FOR HDMI] → [On].
2. Press the SYNC MENU button on the TV remote control, and select the desired mode.
 - If you connect this camera to a TV using an HDMI cable, available menu items are limited.

- Only TVs that support “BRAVIA” Sync can provide SYNC MENU operations. For details, refer to the operating instructions supplied with the TV.
- If the product performs unwanted operations in response to the TV remote control when the product is connected to another manufacturer’s TV using an HDMI connection, select MENU →  (Setup) → [HDMI Settings] → [CTRL FOR HDMI] → [Off].

Hint

- This product is compatible with the PhotoTV HD standard. If you connect Sony PhotoTV HD-compatible devices using an HDMI cable (sold separately), the TV is set to the image quality suitable for viewing still images, and a whole new world of photos can be enjoyed in breathtaking high quality.
- You can connect this product to Sony PhotoTV HD-compatible devices with a USB terminal using the USB cable.
- The PhotoTV HD allows for a highly-detailed, photo-like expression of subtle textures and colors.
- For details, refer to the operating instructions supplied with the compatible TV.



Note

- Do not connect this product and another device using the output terminals of both. Doing so may cause a malfunction.
- Some devices may not work properly when connected to this product. For example, they may not output video or audio.
- Use an HDMI cable with the HDMI logo or a genuine Sony cable.
- Use an HDMI cable that is compatible with the HDMI micro terminal of the product and the HDMI jack of the TV.
- When [ TC Output] is set to [On], the image may not be output properly to the TV or recording device. In such cases, set [ TC Output] to [Off].
- If images do not appear on the TV screen properly, select MENU →  (Setup) → [HDMI Settings] → [HDMI Resolution] → [2160p/1080p], [1080p] or [1080i] according to the TV to be connected.
- During HDMI output, when you switch the movie from 4K to HD image quality or vice-versa, or change the movie to a different frame rate or different color mode, the screen may become dark. This is not a malfunction.
- When [ Proxy Recording] is set to [On], images cannot be output to an HDMI device while recording a 4K movie.

Digital Camera
ZV-1

Memory (Camera Settings1/Camera Settings2)

Allows you to register up to 3 often-used modes or product settings to the product and up to 4 (M1 through M4) to the memory card. You can recall the settings using just the MODE (Mode) button.

- 1 Set the product to the setting you want to register.
- 2 MENU →  1 (Camera Settings1) → [MR  1 /  2 Memory] → desired number.
- 3 Press the center of the control wheel to confirm.

Items that can be registered

- You can register various functions for shooting. The items that can actually be registered are displayed on the menu of the camera.
- Aperture (F number)
- Shutter speed
- Optical zoom scale

To change registered settings

Change the setting to the desired one and re-register the setting to the same mode number.

Note

- M1 through M4 can be selected only when a memory card is inserted into the product.
- Program Shift cannot be registered.

Related Topic

- [Recall \(Camera Settings1/Camera Settings2\)](#)

Add Item

You can register the desired menu items to ★ (My Menu) under MENU.

- 1 MENU → ★ (My Menu) → [Add Item].
- 2 Select an item that you want to add to ★ (My Menu) using the top/bottom/left/right sides of the control wheel.
- 3 Select a destination using the top/bottom/left/right sides of the control wheel.

Hint

- You can add up to 30 items to ★ (My Menu).

Note

- You cannot add the following items to ★ (My Menu).
 - Any item under MENU →  (Playback)
 - [View on TV]

Related Topic

- [Sort Item](#)
- [Delete Item](#)
- [Using MENU items](#)

Digital Camera
ZV-1

Sort Item

You can rearrange the menu items added to ★ (My Menu) under MENU.

- 1 MENU → ★ (My Menu) → [Sort Item].
 - 2 Select an item that you want to move using the top/bottom/left/right sides of the control wheel.
 - 3 Select a destination using the top/bottom/left/right sides of the control wheel.
-
-

Related Topic

- [Add Item](#)

Delete Item

You can delete menu items added to ★ (My Menu) of MENU.

- 1 MENU → ★ (My Menu) → [Delete Item].
- 2 Select an item that you want to delete using the top/bottom/left/right sides of the control wheel, and then press the center to delete the selected item.

Hint

- To delete all the items on a page, select MENU → ★ (My Menu) → [Delete Page].
- You can delete all the items added to ★ (My Menu) by selecting MENU → ★ (My Menu) → [Delete All].

Related Topic

- [Delete Page](#)
- [Delete All](#)
- [Add Item](#)

Digital Camera
ZV-1

Delete Page

You can delete all the menu items added to a page under ★ (My Menu) in MENU.

- 1 MENU → ★ (My Menu) → [Delete Page].
 - 2 Select a page that you want to delete using the left/right sides of the control wheel, and then press the center of the control wheel to delete the items.
-

Related Topic

- [Add Item](#)
- [Delete All](#)

Digital Camera
ZV-1

Delete All

You can delete all the menu items added to ★ (My Menu) in MENU.

1 MENU → ★ (My Menu) → [Delete All].

2 Select [OK].

Related Topic

- [Add Item](#)
- [Delete Page](#)

Digital Camera
ZV-1

Display From My Menu

You can set My Menu to appear first when you press the MENU button.

1 MENU → ★ (My Menu) → [Display From My Menu] → desired setting.

Menu item details

On:

My Menu appears first when you press the MENU button.

Off:

The most recently displayed menu appears when you press the MENU button.

Related Topic

- [Add Item](#)

Digital Camera
ZV-1

Auto Review

You can check the recorded image on the screen right after the shooting. You can also set the display time for Auto Review.

1 MENU →  2 (Camera Settings2) → [Auto Review] → desired setting.

Menu item details

10 Sec/5 Sec/2 Sec:

Displays the recorded image on the screen right after shooting for the selected duration of time. If you perform a magnifying operation during Auto Review, you can check that image using the magnified scale.

Off:

Does not display the Auto Review.

Note

- When you use a function that performs image processing, the image before processing may be displayed temporarily, followed by the image after processing.
- The DISP (Display Setting) settings are applied for the Auto Review display.

Related Topic

- [Enlarging an image being played back \(Enlarge Image\)](#)

Live View Display

Sets whether or not to show images altered with effects of the exposure compensation, white balance, [Creative Style], or [Picture Effect] on the screen.

1 MENU →  2 (Camera Settings2) → [Live View Display] → desired setting.

Menu item details

Setting Effect ON:

Displays Live View in conditions close to what your picture will look like as a result of applying all your settings. This setting is useful when you want to shoot pictures while checking the results of the shot on the Live View screen.

Setting Effect OFF:

Displays Live View without the effects of exposure compensation, white balance, [Creative Style], or [Picture Effect]. When this setting is used, you can easily check the image composition.

Live View is always displayed with the appropriate brightness even in [Manual Exposure] mode.

When [Setting Effect OFF] is selected, the **VIEW** (VIEW) icon is displayed on the Live View screen.

Hint

- When you use a third-party flash, such as a studio flash, Live View Display may be dark for some shutter speed settings. When [Live View Display] is set to [Setting Effect OFF], Live View Display will be displayed brightly, so that you can easily check the composition.

Note

- [Live View Display] cannot be set to [Setting Effect OFF] in the following shooting modes:
 - [Intelligent Auto]
 - [Sweep Panorama]
 - [Movie]
 - [High Frame Rate]
 - [Scene Selection]
 - [ Intelligent Auto]
- When [Live View Display] is set to [Setting Effect OFF], the brightness of the shot image will not be the same as that of the displayed Live View.

Grid Line

Sets whether the grid line is displayed or not. The grid line will help you to adjust the composition of images.

1 MENU →  2 (Camera Settings2) → [Grid Line] → **desired setting.**

Menu item details

Rule of 3rds Grid:

Place main subjects close to one of the grid lines that divide the image into thirds for a well-balanced composition.

Square Grid:

Square grids make it easier to confirm the horizontal level of your composition. This is useful for assessing the composition when shooting landscapes, closeups, or when performing camera scanning.

Diag. + Square Grid:

Place a subject on the diagonal line to express an uplifting and powerful feeling.

Off:

Does not display the grid line.

Monitor Brightness

Adjust the brightness of the screen.

- 1 MENU →  (Setup) → [Monitor Brightness] → desired setting.

Menu item details



Manual:

Adjusts the brightness within the range of -2 to +2.

Sunny Weather:

Sets the brightness appropriately for shooting outdoors.

Note

- The [Sunny Weather] setting is too bright for shooting indoors. Set [Monitor Brightness] to [Manual] for indoor shooting.
- The monitor brightness cannot be adjusted in the following situations. The maximum brightness will be [±0].
 - When [ File Format] is set to [XAVC S 4K].
 - When [ File Format] is set to [XAVC S HD] and [ Record Setting] is set to [120p]/[100p].
- The monitor brightness is locked at [-2] when shooting a movie using the Wi-Fi functions.
- The monitor brightness is locked at [-2] when an overheating warning is displayed.

Digital Camera
ZV-1

Power OFF w/ monitor

Sets whether or not the power turns off when the monitor is closed facing inward.

1 MENU →  (Setup) → [Power OFF w/ monitor] → **desired setting.**

Menu item details

Power OFF:

The power turns off when the monitor is closed facing inward.

Not Power OFF:

The power does not turn off when the monitor is closed facing inward.

Hint

- When you want to keep shooting images with the monitor closed facing inward, such as during interval shooting or movie recording, set [Power OFF w/ monitor] to [Not Power OFF].

Digital Camera
ZV-1

Auto Monitor OFF

The camera automatically switches to the power-saving mode if you do not operate the camera for a certain period of time in the still-image shooting mode. This function is useful for reducing the power consumption.

1 MENU →  (Setup) → [Auto Monitor OFF] → desired setting

Menu item details

Does not turn OFF:

The camera does not switch to the power-saving mode automatically.

2 Sec/5 Sec/10 Sec:

The camera switches to the power-saving mode and the monitor turns off if a certain number of seconds elapses without any operations.



When [5 Sec] or [10 Sec] is selected, the monitor darkens two seconds before the end of the duration you have set.

Note

- [Auto Monitor OFF] does not activate in the following situations:
 - When the monitor is facing forward
 - When the shooting mode is set to [Sweep Panorama]
 - In cases which the power-saving function will not activate (As an exception, [Auto Monitor OFF] will activate when [Bluetooth Rmt Ctrl] is set to [On].)

Bright Monitoring

Allows you to adjust the composition when shooting in dark environments. By extending the exposure time, you can check the composition on the monitor even in dark locations such as under the night sky.

- 1 MENU →  2 (Camera Settings2) → [ Custom Key] → assign the [Bright Monitoring] function to the desired key.
- 2 Press the key to which you assigned the [Bright Monitoring] function, then shoot an image.
 - The brightness due to [Bright Monitoring] will continue after shooting.
 - To return the monitor brightness to normal, press the key to which you assigned the [Bright Monitoring] function once again.

Note

- During [Bright Monitoring], [Live View Display] will automatically switch to [Setting Effect OFF], and setting values such as exposure compensation will not be reflected in the live view display. It is recommended that you use [Bright Monitoring] only in dark locations.
- [Bright Monitoring] will be automatically cancelled in the following situations.
 - When the camera is turned off.
 - When the shooting mode is changed from P/A/S/M to a mode that is not P/A/S/M.
 - When the focus mode is set to other than manual focus.
 - When [ MF Assist] is executed.
 - When [Focus Magnifier] is selected.
- During [Bright Monitoring], the shutter speed may be slower than normal while shooting in dark locations. Also, because the measured brightness range is expanded, the exposure may change.

Related Topic

- [Live View Display](#)

Format

When you use a memory card with this camera for the first time, we recommend that you format the card using the camera for stable performance of the memory card. Note that formatting permanently erases all data on the memory card, and is unrecoverable. Save valuable data on a computer, etc.

1 MENU →  (Setup) → [Format].

Note

- Formatting permanently erases all data including protected images and registered settings (from M1 to M4).
- The access lamp lights up during formatting. Do not remove the memory card while the access lamp is lit up.
- Format the memory card on this camera. If you format the memory card on the computer, the memory card may not be usable depending on the format type.
- It may take a few minutes to complete formatting, depending on the memory card.
- You cannot format the memory card if the remaining battery charge is less than 1%.

Digital Camera
ZV-1

Select REC Folder

If [Folder Name] under [ File/Folder Settings] is set to [Standard Form] and there are 2 folders or more, you can select the folder on the memory card to which images are to be recorded.

1 MENU →  (Setup) → [Select REC Folder] → desired folder.

Note

- You cannot select the folder when [Folder Name] under [ File/Folder Settings] is set to [Date Form].

Related Topic

- [File/Folder Settings \(still image\)](#)

Digital Camera
ZV-1

New Folder

Creates a new folder on the memory card for recording still images. A new folder is created with a folder number one greater than the largest folder number currently used. Images are recorded in the newly created folder.

1 MENU →  (Setup) → [New Folder].

Note

- When you insert a memory card that was used with other equipment into this product and shoot images, a new folder may be automatically created.
- Up to 4,000 images in total can be stored in one folder. When the folder capacity is exceeded, a new folder may be automatically created.

Digital Camera
ZV-1

File/Folder Settings (still image)

Sets file names for still images to be shot, and specifies folders for storing the shot still images.

1 MENU →  (Setup) → [ File/Folder Settings] → desired setting.

Menu item details

File Number:

You can set how to assign file numbers to still images.

[Series]: Does not reset file numbers for each folder.

[Reset]: Resets file numbers for each folder.

Set File Name:

You can specify the first three characters of the file name.

Folder Name:

You can set how folder names are assigned.

[Standard Form]: Folders are named as “folder number + MSDCF”.

Example: 100MSDCF

[Date Form]: Folders are named as “folder number + Y (the last digit of the year)/MM/DD”.

Example: 10000405 (Folder number: 100; date: 04/05/2020)



Note

- Only capital letters, numbers, and underscores can be used for [Set File Name]. Underscores cannot be used for the first character.
- The three characters specified using [Set File Name] are only applied to files recorded after the setting is made.

Digital Camera
ZV-1

File Settings (movie)

Configure settings for the file names of recorded movies.

1 MENU →  (Setup) → [ File Settings] → desired setting.

Menu item details

File Number:

You can set how to assign file numbers to movies.

[Series]: Does not reset file numbers even if the memory card is changed.

[Reset]: Resets the file number when the memory card is changed.

Series Counter Reset:

Resets the series counter used when [File Number] is set to [Series].

File Name Format:

You can set the format for movie file names.

[Standard]: The file name of the recorded movie starts with "C." Example: C0001

[Title]: The file name of the recorded movie becomes "Title+File number."

[Date + Title]: The file name of the recorded movie becomes "Date+Title+File number."

[Title + Date]: The file name of the recorded movie becomes "Title+Date+ File number."

Title Name Settings:

You can set the title when [File Name Format] is set to [Title], [Date + Title], or [Title + Date].

Note

- Only alphanumeric characters and symbols can be input for [Title Name Settings]. Up to 37 characters can be entered.
- Titles specified using [Title Name Settings] are only applied to movies recorded after the setting is made.
- [ File Settings] does not apply to AVCHD movies.
- You cannot set how folder names are assigned for movies.
- If you are using an SDHC memory card, [File Name Format] is locked to [Standard].
- If there are unused numbers due to file deletion, etc., these numbers will be reused when the movie file number reaches "9999."

Digital Camera
ZV-1

Display Media Info.

Displays the recordable time of movies for the inserted memory card. Also displays the number of recordable still images for the inserted memory card.

① MENU →  (Setup) → [Display Media Info.]

Digital Camera
ZV-1

Recover Image DB

If image files were processed on a computer, problems may occur in the image database file. In such cases, the images on the memory card will not be played back on this product. If these problems happen, repair the file using [Recover Image DB].

1 MENU →  (Setup) → [Recover Image DB] → [Enter].

Note

- If the battery pack is extremely depleted, image database files cannot be repaired. Use a sufficiently charged battery pack.
- Images recorded on the memory card are not deleted by [Recover Image DB].

Audio signals

Selects whether the product produces a sound or not.

1 MENU →  2 (Camera Settings2) → [Audio signals] → desired setting.

Menu item details

On:all:

Sounds are produced for example when the focus is achieved by pressing the shutter button halfway down.

On:Shutter Only:

Only the shutter sound is produced.

Off:



Sounds are not produced.

Note

- If [Focus Mode] is set to [Continuous AF], the camera will not beep when it focuses on a subject.

Write Date (still image)

Sets whether to record a shooting date on the still image.

1 MENU →  2 (Camera Settings2) → [ Write Date] → desired setting.

Menu item details

On:

Records a shooting date.

Off:

Does not record a shooting date.

Note

- If you shoot images with the date once, you cannot delete the date from the images later.
- The dates are doubly printed if you set the product to print dates when printing the images using PCs or printers.
- The recorded time of the image cannot be superimposed on the image.
- [ Write Date] is not available for RAW images.

Digital Camera
ZV-1

Tile Menu

Selects whether to always display the first screen of the menu when you press the MENU button.

1 MENU →  (Setup) → [Tile Menu] → desired setting.

Menu item details

On:

Always displays the first screen of the menu (Tile Menu).

Off:

Deactivates the Tile Menu display.

Digital Camera
ZV-1

Power Save Start Time

You can set the time by which the power goes off automatically.

1 MENU →  (Setup) → [Power Save Start Time] → desired setting.

Menu item details

30 Min/5 Min/2 Min/1 Min

Note

- The power save function is deactivated in the following situations:
 - While power is being supplied via USB
 - While playing back slideshows
 - While recording movies
 - While connected to a computer or TV
 - When [Bluetooth Rmt Ctrl] is set to [On]

Digital Camera
ZV-1

Auto Power OFF Temp.

Sets the temperature of the camera at which the camera turns off automatically during shooting. When it is set to [High], you can continue shooting even when the temperature of the camera gets hotter than normal.

1 MENU →  (Setup) → [Auto Power OFF Temp.] → desired setting.

Menu item details

Standard:

Sets the standard temperature for the camera to turn off.

High:

Sets the temperature at which the camera turns off to higher than [Standard].

Notes when [Auto Power OFF Temp.] is set to [High]

- Do not shoot while holding the camera in your hand. Use a tripod.
- Using the camera while holding it in your hand for a long period of time may cause low-temperature burns.

Continuous recording time for movies when [Auto Power OFF Temp.] is set to [High]

The duration of time available for continuous movie recording is as follows when the camera starts recording with the default settings after the power has been turned off for a while. The following values indicate the continuous time from when the camera starts recording until the camera stops recording.

Ambient temperature: 20°C (68°F)

Continuous recording time for movies (HD): Approx. 30 minutes

Continuous recording time for movies (4K): Approx. 30 minutes

Ambient temperature: 30°C (86°F)

Continuous recording time for movies (HD): Approx. 30 minutes

Continuous recording time for movies (4K): Approx. 30 minutes

Ambient temperature: 40°C (104°F)

Continuous recording time for movies (HD): Approx. 20 minutes

Continuous recording time for movies (4K): Approx. 20 minutes

HD: XAVC S HD (60p 50M/50p 50M, when the camera is not connected via Wi-Fi)

4K: XAVC S 4K (24p 60M/25p 60M, when the camera is not connected via Wi-Fi)

Note

- Even if [Auto Power OFF Temp.] is set to [High], depending on the conditions or the temperature of the camera, the recordable time for movies may not change.

Related Topic

- [Recordable movie times](#)

Digital Camera
ZV-1

NTSC/PAL Selector

Plays back movies recorded with the product on a NTSC/PAL system TV.

1 MENU →  (Setup) → [NTSC/PAL Selector] → [Enter]

Note

- If you insert a memory card that has previously been formatted with a different video system, a message telling you that you must reformat the card will appear.
If you want to record using another system, re-format the memory card or use another memory card.
- When you perform [NTSC/PAL Selector], and the setting is changed from the default one, a message "Running on NTSC." or "Running on PAL." will appear on the start-up screen.

Digital Camera
ZV-1

HDMI Settings: HDMI Resolution

When you connect the product to a High Definition (HD) TV with HDMI terminals using an HDMI cable (sold separately), you can select HDMI Resolution to output images to the TV.

1 MENU →  (Setup) → [HDMI Settings] → [HDMI Resolution] → desired setting.

Menu item details

Auto:

The product automatically recognizes an HD TV and sets the output resolution.

2160p/1080p:

Outputs signals in 2160p/1080p.

1080p:

Outputs signals in HD picture quality (1080p).

1080i:

Outputs signals in HD picture quality (1080i).



Note

- If the images are not displayed properly using the [Auto] setting, select either [1080i], [1080p] or [2160p/1080p], based on which TV is to be connected.

Digital Camera
ZV-1

HDMI Settings: 24p/60p Output (movie) (Only for 1080 60i compatible models)

You can set 1080/24p or 1080/60p as the HDMI output format when [ Record Setting] is set to [24p 50M], [24p 60M] or [24p 100M].

- 1 MENU →  (Setup) → [HDMI Settings] → [HDMI Resolution] → [1080p] or [2160p/1080p].
- 2 MENU →  (Setup) → [HDMI Settings] → [ 24p/60p Output] → desired setting.

Menu item details

60p:

Movies are output as 60p.

24p:

Movies are output as 24p.

Note

- Steps 1 and 2 can be set in either order.

Related Topic

- [Record Setting \(movie\)](#)

Digital Camera
ZV-1

HDMI Settings: HDMI Info. Display

Selects whether to display the shooting information when this product and the TV are connected using an HDMI cable (sold separately).

1 MENU →  (Setup) → [HDMI Settings] → [HDMI Info. Display] → desired setting.

Menu item details

On:

Displays the shooting information on the TV.

The recorded image and the shooting information are displayed on the TV, while nothing is displayed on the camera's monitor.

Off:

Does not display the shooting information on the TV.

Only the recorded image is displayed on the TV, while the recorded image and the shooting information are displayed on the camera's monitor.

Note

- When the camera is connected to an HDMI device while [ File Format] is set to [XAVC S 4K], the setting switches to [Off].

Digital Camera
ZV-1

HDMI Settings: TC Output (movie)

Sets whether or not to layer the TC (time code) information on the output signal via the HDMI terminal when outputting the signal to other professional-use devices.

This function layers the time code information on the HDMI output signal. The product sends the time code information as digital data, not as an image displayed on the screen. The connected device can then refer to the digital data to recognize the time data.

1 MENU →  (Setup) → [HDMI Settings] → [ TC Output] → desired setting.

Menu item details



On:

Time code is output to other devices.

Off:

Time code is not output to other devices.

Note

- When [ TC Output] is set to [On], the image may not be output properly to the TV or recording device. In such cases, set [ TC Output] to [Off].

Digital Camera
ZV-1

HDMI Settings: REC Control (movie)

If you connect the camera to an external recorder/player, you can remotely command the recorder/player to start/stop recording using the camera.

1 MENU →  (Setup) → [HDMI Settings] → [ REC Control] → desired setting.

Menu item details

On:









 STBY (STBY) The camera can send a recording command to an external recorder/player.

 REC (REC) The camera is sending a recording command to an external recorder/player.

Off:

The camera is not able to send a command to an external recorder/player to start/stop recording.

Note

- Available for external recorders/players compatible with [ REC Control].
- When you use the [ REC Control] function, set the shooting mode to  (Movie) or  ( Intelligent Auto).
- When [ TC Output] is set to [Off], you cannot use the [ REC Control] function.
- Even when  REC (REC) is displayed, the external recorder/player may not work properly depending on the settings or status of the recorder/player. Check if the external recorder/player works properly before use.

Digital Camera
ZV-1

HDMI Settings: CTRL FOR HDMI

When connecting this product to a “BRAVIA” Sync-compatible TV using an HDMI cable (sold separately), you can operate this product by aiming the TV remote control at the TV.

- 1 **MENU** →  (Setup) → [HDMI Settings] → [CTRL FOR HDMI] → **desired setting**.
- 2 **Connect this product to a “BRAVIA” Sync-compatible TV.**
The input of the TV is switched automatically and images on this product are displayed on the TV screen.
- 3 **Press the SYNC MENU button of the TV’s remote control.**
- 4 **Operate this product using the TV’s remote control.**

Menu item details

On:

You can operate this product with a TV’s remote control.

Off:

You cannot operate this product with a TV’s remote control.

Note

- If you connect this product to a TV using an HDMI cable, available menu items are limited.
- [CTRL FOR HDMI] is available only with a “BRAVIA” Sync-compatible TV. Also, the SYNC MENU operation differs depending on the TV you are using. For details, refer to the operating instructions supplied with the TV.
- If the product performs unwanted operations in response to the TV remote control when the product is connected to another manufacturer’s TV using an HDMI connection, select MENU →  (Setup) → [HDMI Settings] → [CTRL FOR HDMI] → [Off].

Digital Camera
ZV-1

USB Connection

Selects the USB connection method when this product is connected to a computer, etc.

Select MENU →  (Network) → [Ctrl w/ Smartphone] → [Ctrl w/ Smartphone] → [Off] beforehand.

Also, when you set MENU →  (Network) → [PC Remote Function] → [PC Remote Cnct Method] to [USB], set [PC Remote] under [PC Remote Function] to [Off].

1 MENU →  (Setup) → [USB Connection] → desired setting.

Menu item details

Auto:

Establishes a Mass Storage or MTP connection automatically, depending on the computer or other USB devices to be connected. Windows 8.1 or Windows 10 computers are connected in MTP, and their unique functions are enabled for use.

Mass Storage:

Establishes a Mass Storage connection between this product, a computer, and other USB devices.

MTP:

Establishes an MTP connection between this product, a computer, and other USB devices. Windows 8.1 or Windows 10 computers are connected in MTP, and their unique functions are enabled for use.

Note

- It may take some time to make the connection between this product and a computer when [USB Connection] is set to [Auto].

Digital Camera
ZV-1

USB LUN Setting

Enhances compatibility by limiting of USB connection functions.

1 MENU →  (Setup) → [USB LUN Setting] → desired setting.

Menu item details

Multi:

Normally, use [Multi].

Single:

Set [USB LUN Setting] to [Single] only if you cannot make a connection.

USB Power Supply

Sets whether to supply power via the micro USB cable when the product is connected to a computer or an USB device.

1 MENU →  (Setup) → [USB Power Supply] → desired setting.

Menu item details

On:

Power is supplied to the product via a micro USB cable when the product is connected to a computer, etc.

Off:

Power is not supplied to the product via a micro USB cable when the product is connected to a computer, etc.

Operations available while supplying power via a USB cable

The following table shows you which operations are available/unavailable while supplying power via a USB cable.

Operation	Available / Unavailable
Shooting images	Available
Playing back images	Available
Wi-Fi/Bluetooth connections	Available
Charging a battery pack	Unavailable
Turning the camera on without a battery pack inserted	Unavailable

Note

- Insert the battery pack into the product to supply power via USB cable.

Digital Camera
ZV-1

Language

Selects the language to be used in the menu items, warnings and messages.

1 MENU →  (Setup) → [ Language] → **desired language.**

Digital Camera
ZV-1

Date/Time Setup

The Clock Set screen is displayed automatically when you turn on this product for the first time or when the internal rechargeable backup battery has fully discharged. Select this menu when setting the date and time after the first time.

1 MENU →  (Setup) → [Date/Time Setup] → desired setting.

Menu item details

Daylight Savings:

Selects Daylight Savings [On]/[Off].

Date/Time:

Sets the date and time.

Date Format:

Selects the date and time display format.

Hint

- To charge the internal rechargeable backup battery, insert a charged battery pack, and leave the product for 24 hours or more with the power off.
- If the clock resets every time the battery is charged, the internal rechargeable backup battery may be worn out. Consult your service facility.

Digital Camera
ZV-1

Area Setting

Sets the area where you are using the product.

1 MENU →  (Setup) → [Area Setting] → desired area.

Digital Camera
ZV-1

Version

Displays the version of this product's software. Check the version when updates for this product's software are released, etc.

1 MENU →  (Setup) → [Version].

Note

- Updating can be performed only when the battery level is  (3 remaining battery bars) or more. Use a sufficiently charged battery pack.

Demo Mode

The [Demo Mode] function displays the movies recorded on the memory card automatically (demonstration), when the camera has not been operated for a certain time. Normally select [Off].

1 MENU →  (Setup) → [Demo Mode] → desired setting.

Menu item details

On:

The movie playback demonstration starts automatically if the product is not operated for about one minute. Only protected AVCHD movies can be played back.

Set the view mode to [AVCHD View], and protect the movie file with the oldest recorded date and time.

Off:

Does not show the demonstration.

Note

- When there is no protected AVCHD movies on the memory card, you cannot select [On].

Setting Reset

Resets the product to the default settings. Even if you perform [Setting Reset], the recorded images are retained.

1 MENU →  (Setup) → [Setting Reset] → desired setting.

Menu item details

Camera Settings Reset:

Initializes the main shooting settings to the default settings.

Initialize:

Initializes all the settings to the default settings.

Note

- Be sure not to eject the battery pack while resetting.
- Settings of [Picture Profile] will not be reset even when [Camera Settings Reset] or [Initialize] is performed.

Imaging Edge Mobile

Using the smartphone application Imaging Edge Mobile, you can shoot an image while controlling the camera using a smartphone or transfer the images recorded on the camera to the smartphone. Download and install the application Imaging Edge Mobile from your smartphone's application store. If Imaging Edge Mobile is already installed on your smartphone, be sure to update it to the latest version.

For details on Imaging Edge Mobile, refer to the support page (<https://www.sony.net/iem/>).

Note

- Depending on future version upgrades, the operational procedures or screen displays are subject to change without notice.

Digital Camera
ZV-1

Ctrl w/ Smartphone

Sets the condition for connecting the camera to a smartphone.

1 MENU →  (Network) → [Ctrl w/ Smartphone] → desired setting.

Menu item details

Ctrl w/ Smartphone:

Sets whether to connect the camera and a smartphone using Wi-Fi. ([On]/[Off])

Connection:

Displays the QR code or SSID used to connect the camera to a smartphone.

Always Connected:

Sets whether to keep the camera connected to a smartphone. If this item is set to [On], once you connect the camera to a smartphone, it will remain connected to the smartphone at all times. If it is set to [Off], the camera will connect to a smartphone only when the connection procedure is performed.

Note

- If [Always Connected] is set to [On], the power consumption will be greater than when it is set to [Off].

Related Topic

- [Controlling the camera using an Android smartphone \(QR Code\)](#)
- [Controlling the camera using an Android smartphone \(SSID\)](#)
- [Controlling the camera using an iPhone or iPad \(QR Code\)](#)
- [Controlling the camera using an iPhone or iPad \(SSID\)](#)
- [Send to Smartphone Func.: Send to Smartphone](#)

Controlling the camera using an Android smartphone (QR Code)

You can control this product using your smartphone by connecting your smartphone to the camera using the QR Code. Make sure that [Ctrl w/ Smartphone] is set to [On] by selecting MENU →  (Network) → [Ctrl w/ Smartphone].

- 1 MENU →  (Network) → [Ctrl w/ Smartphone] → [ Connection].

QR Code (A) and the SSID (B) are displayed on the monitor of this product.

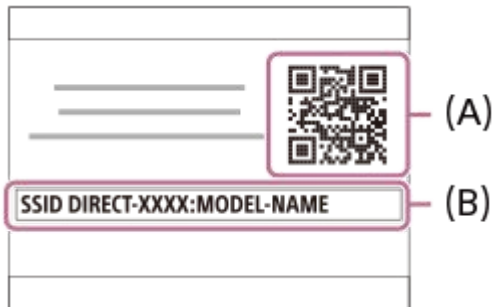

- 2 Launch Imaging Edge Mobile on your smartphone and select [Scan QR Code of the Camera].

- 3 Select [OK] on the smartphone screen.

- When a message is displayed, select [OK] again.

- 4 Read the QR Code displayed on the monitor of this product with the smartphone.

Once the QR Code has been read, a message [Connect with the camera?] will be displayed on the smartphone screen.

- 5 Select [OK] on the smartphone screen.

The smartphone is connected to the product.

- You can now shoot images remotely while checking the composition on the smartphone screen.

Hint

- Once the QR Code has been read, this product's SSID (DIRECT-xxxx) and password are registered to the smartphone. This enables you to easily connect the smartphone to the product via Wi-Fi at a later date by selecting the SSID. (Set [Ctrl w/ Smartphone] to [On] in advance.)

Note

- Radio wave interference may occur as Bluetooth communications and Wi-Fi (2.4 GHz) communications use the same frequency band. If your Wi-Fi connection is unstable, it may be improved by turning off the Bluetooth function of the smartphone. If you do this, the location information link function is not available.
- When you record movies using a smartphone as a remote controller, the monitor of the product becomes darker.
- If you cannot connect your smartphone to this product using the QR Code, use the SSID and password.

Related Topic

- [Imaging Edge Mobile](#)
- [Controlling the camera using an Android smartphone \(SSID\)](#)

5-016-934-11(1) Copyright 2020 Sony Corporation

Digital Camera
ZV-1

Controlling the camera using an Android smartphone (SSID)

You can control this product using your smartphone by connecting your smartphone to the camera using the SSID and password.

Make sure that [Ctrl w/ Smartphone] is set to [On] by selecting MENU →  (Network) → [Ctrl w/ Smartphone].

- 1 MENU →  (Network) → [Ctrl w/ Smartphone] → [ Connection].

QR Code is displayed on the monitor of this product.

- 2 Press the  (Delete) button of this product.

This product's SSID and password are displayed on the monitor of this product.



- 3 Launch Imaging Edge Mobile on your smartphone.
- 4 Select the model name of this product (DIRECT-xxxx: xxxx).
- 5 Input the password that is displayed on this product.

The smartphone is connected to the product.

- You can now shoot images remotely while checking the composition on the smartphone screen.

Note

- Radio wave interference may occur as Bluetooth communications and Wi-Fi (2.4 GHz) communications use the same frequency band. If your Wi-Fi connection is unstable, it may be improved by turning off the Bluetooth function of the smartphone. If you do this, the location information link function is not available.
- When you record movies using a smartphone as a remote controller, the monitor of the product becomes darker.

Related Topic

- [Imaging Edge Mobile](#)

Controlling the camera using an iPhone or iPad (QR Code)

You can connect an iPhone or iPad to the camera using the QR Code and operate the camera using the iPhone or iPad. Make sure that [Ctrl w/ Smartphone] is set to [On] by selecting MENU →  (Network) → [Ctrl w/ Smartphone].

- 1 MENU →  (Network) → [Ctrl w/ Smartphone] → [ Connection].

QR Code (A) and the SSID (B) are displayed on the monitor of this product.

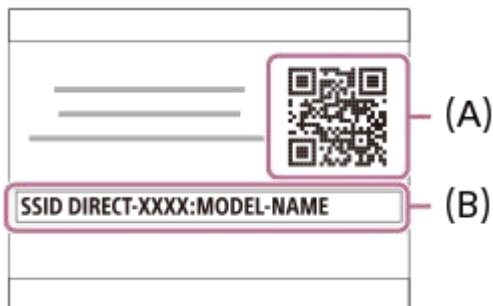

- 2 Launch Imaging Edge Mobile on your iPhone or iPad and select [Scan QR Code of the Camera].

- 3 Select [OK] on the iPhone or iPad screen.

- When a message is displayed, select [OK] again.

- 4 Read the QR Code displayed on the monitor of this product with the iPhone or iPad.

The iPhone or iPad will connect to the product.

- You can now shoot images remotely while checking the composition on the screen of your iPhone or iPad.

Hint

- Once the QR Code has been read, this product's SSID (DIRECT-xxxx) and password are registered to the iPhone or iPad. This enables you to easily connect the iPhone or iPad to the product via Wi-Fi at a later date by selecting the SSID. (Set [Ctrl w/ Smartphone] to [On] in advance.)

Note

- Radio wave interference may occur as Bluetooth communications and Wi-Fi (2.4 GHz) communications use the same frequency band. If your Wi-Fi connection is unstable, it may be improved by turning off the Bluetooth function of the smartphone. If you do this, the location information link function is not available.
- When you record movies using a smartphone as a remote controller, the monitor of the product becomes darker.
- If you cannot connect your iPhone or iPad to this product using the QR Code, use the SSID and password.

Related Topic

- [Imaging Edge Mobile](#)

- Controlling the camera using an iPhone or iPad (SSID)

5-016-934-11(1) Copyright 2020 Sony Corporation

Controlling the camera using an iPhone or iPad (SSID)

You can control the camera using an iPhone or iPad by connecting the iPhone or iPad to the camera using the SSID and password.

Make sure that [Ctrl w/ Smartphone] is set to [On] by selecting MENU →  (Network) → [Ctrl w/ Smartphone].

- 1 MENU →  (Network) → [Ctrl w/ Smartphone] → [ Connection].

QR Code is displayed on the monitor of this product.

- 2 Press the  (Delete) button of this product.

This product's SSID and password are displayed on the monitor of this product.



- 3 Select the model name of this product (DIRECT-xxxx: xxxx) on the Wi-Fi setting screen of your iPhone or iPad.



- 4 Input the password that is displayed on this product.



The iPhone or iPad is connected to the product.

5 Confirm that your iPhone or iPad was connected to the “SSID” shown on this product.

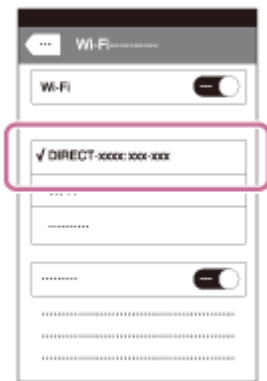

6 Return to the "Home" screen of the iPhone or iPad and launch Imaging Edge Mobile.

- You can now shoot images remotely while checking the composition on the screen of your iPhone or iPad.

Note

- Radio wave interference may occur as Bluetooth communications and Wi-Fi (2.4 GHz) communications use the same frequency band. If your Wi-Fi connection is unstable, it may be improved by turning off the Bluetooth function of the smartphone. If you do this, the location information link function is not available.
- When you record movies using a smartphone as a remote controller, the monitor of the product becomes darker.

Related Topic

- [Imaging Edge Mobile](#)

Send to Smartphone Func.: Send to Smartphone

You can transfer still images, XAVC S movies, or high-frame-rate movies to a smartphone and view them. The application Imaging Edge Mobile must be installed on your smartphone.

1 MENU → (Network) → [Send to Smartphone Func.] → [Send to Smartphone] → desired setting.

- If you press the  (Send to Smartphone) button in playback mode, the setting screen for [Send to Smartphone] will appear.

2 If the product is ready for the transfer, the information screen appears on the product. Connect the smartphone and the product using that information.

- The setting method for connecting the smartphone and the product varies depending on the smartphone.



Menu item details

Select on This Device:

Selects an image on the product to be transferred to the smartphone.

(1) Select from among [This Image], [All with this date] or [Multiple Images].

- The options displayed may differ depending on the View Mode selected on the camera.

(2) If you select [Multiple Images], select the desired images using the center of the control wheel, then press MENU → [Enter].

Select on Smartphone:

Displays all images recorded on the product's memory card on the smartphone.

Note

- You can only transfer images that are saved on the camera's memory card.
- You can select an image size to be sent to the smartphone from [Original], [2M] or [VGA]. To change the image size, refer to the following steps.
 - For Android smartphone
Start Imaging Edge Mobile, and change the image size by [Settings] → [Copy Image Size].
 - For iPhone/iPad
Select Imaging Edge Mobile in the setting menu, and change the image size by [Copy Image Size].
- RAW images are converted to JPEG format when they are sent.
- You cannot send AVCHD format movies.
- Depending on the smartphone, the transferred movie may not be played back correctly. For example, the movie may not play smoothly, or there may be no sound.

- Depending on the format of the still image, movie, or high-frame-rate movie, it may not be possible to play it back on a smartphone.
- This product shares the connection information for [Send to Smartphone] with a device that has permission to connect. If you want to change the device that is permitted to connect to the product, reset the connection information by following these steps. MENU →  (Network) → [Wi-Fi Settings] → [SSID/PW Reset]. After resetting the connection information, you must register the smartphone again.
- When [Airplane Mode] is set to [On], you cannot connect this product and the smartphone. Set [Airplane Mode] to [Off].
- While you transfer large numbers of images or long movies, we recommend that you supply power to the camera from a wall outlet (wall socket) using an AC adaptor, etc.

Related Topic

- [Imaging Edge Mobile](#)
- [Controlling the camera using an Android smartphone \(QR Code\)](#)
- [Controlling the camera using an Android smartphone \(SSID\)](#)
- [Controlling the camera using an iPhone or iPad \(QR Code\)](#)
- [Controlling the camera using an iPhone or iPad \(SSID\)](#)
- [Send to Smartphone Func.: Sending Target \(proxy movies\)](#)
- [Airplane Mode](#)

Digital Camera
ZV-1

Send to Smartphone Func.: Sending Target (proxy movies)

When transferring XAVC S video to a smartphone with [Send to Smartphone], you can set whether to transfer the low-bit-rate proxy movie or the high-bit-rate original movie.

1 MENU →  (Network) → [Send to Smartphone Func.] → [ Sending Target] → desired setting.

Menu item details

Proxy Only:

Transfers only proxy movies.

Original Only:

Transfers only original movies.

Proxy & Original:

Transfers both proxy and original movies.

Note

- While you transfer large numbers of images or long movies, we recommend that you supply power to the camera from a wall outlet (wall socket) using an AC adaptor, etc.

Related Topic

- [Send to Smartphone Func.: Send to Smartphone](#)
- [Proxy Recording](#)

Send to Smartphone Func.: Cnct. during Power OFF

Sets whether or not to accept Bluetooth connections from a smartphone while the camera is turned off. When [Cnct. during Power OFF] is set to [On], you can browse images on the camera's memory card and transfer images from the camera to a smartphone by operating the smartphone.

- 1 MENU →  (Network) → [Send to Smartphone Func.] → [Cnct. during Power OFF] → desired setting.

Menu Item Details

On :

Accepts Bluetooth connections from a smartphone while the camera is turned off.



The battery level is depleted gradually while the camera is turned off. If you do not want to use [Cnct. during Power OFF], turn it off.

Off :

Does not accept Bluetooth connections from a smartphone while the camera is turned off.

How to browse/transfer images on the smartphone

Advance Preparation

1. Select MENU →  (Network) → [Bluetooth Settings] → [Bluetooth Function] → [On] on the camera.
2. MENU →  (Network) → [Send to Smartphone Func.] → [Cnct. during Power OFF] → [On].
3. Select MENU →  (Network) → [Bluetooth Settings] → [Pairing] on the camera to display the screen for pairing.
4. Launch Imaging Edge Mobile on the smartphone, and then select the camera to be paired on the [Camera Remote Power ON/OFF] screen.

Operations

1. Turn off the camera.
2. Select the camera on the [Camera Remote Power ON/OFF] screen of Imaging Edge Mobile to turn on the camera.
 - The camera's power lamp will light up, and the browsing and transferring functions will become available.

Note

- If the smartphone is not operated for a certain period of time, the Bluetooth connection will become deactivated. Select [Camera Remote Power ON/OFF] again on the smartphone.
- When the camera is turned on, the camera switches to the shooting mode, and [Send to Smartphone Func.] ends.

Related Topic

- [Imaging Edge Mobile](#)
- [Send to Smartphone Func.: Send to Smartphone](#)
- [Bluetooth Settings](#)

Location Info. Link Set.

You can use the application Imaging Edge Mobile to obtain location information from a smartphone that is connected with your camera using Bluetooth communication. You can record the obtained location information when shooting images.

Preparation in advance









To use the location information linking function of the camera, the application Imaging Edge Mobile is required. If “Location Information Linkage” is not displayed on the top page of Imaging Edge Mobile, you need to perform the following steps beforehand.



1. Install Imaging Edge Mobile on your smartphone.
 - You can install Imaging Edge Mobile from the application store of your smartphone. If you have already installed the application, update it to the latest version.
2. Transfer a pre-recorded image to your smartphone using the [Send to Smartphone] function of the camera.
 - After you transfer an image recorded using the camera to your smartphone, “Location Information Linkage” will appear on the top page of the application.

Operating procedure

: Operations performed on the smartphone

: Operations performed on the camera

1. : Confirm that the Bluetooth function of your smartphone is activated.
 - Do not perform the Bluetooth pairing operation on the smartphone setting screen. In steps 2 to 7, the pairing operation is performed using the camera and the application Imaging Edge Mobile.
 - If you accidentally perform the pairing operation on the smartphone setting screen in step 1, cancel the pairing and then perform the pairing operation by following Steps 2 through 7 using the camera and the application Imaging Edge Mobile.
2. : On the camera, select MENU →  (Network) → [Bluetooth Settings] → [Bluetooth Function] → [On].
3. : On the camera, select MENU →  (Network) → [Bluetooth Settings] → [Pairing].
4. : Launch Imaging Edge Mobile on your smartphone and tap “Location Information Linkage.”
 - If “Location Information Linkage” is not displayed, follow the steps in “Preparation in advance” above.
5. : Activate [Location Information Linkage] on the [Location Information Linkage] setting screen of Imaging Edge Mobile.
6. : Follow the instructions on the [Location Information Linkage] setting screen of Imaging Edge Mobile, and then select your camera from the list.
7. : Select [OK] when a message is displayed on the monitor of the camera.
 - Pairing of the camera and Imaging Edge Mobile is complete.

8.  : On the camera, select MENU →  (Network) → [ Location Info. Link Set.] → [Location Info. Link] → [On].

-  (obtaining location information icon) will be displayed on the monitor of the camera. Location information obtained by your smartphone using GPS, etc., will be recorded when shooting images.

Menu item details

Location Info. Link:

Sets whether to obtain the location information by linking with a smartphone.

Auto Time Correct.:

Sets whether to automatically correct the date setting of the camera using information from a linked smartphone.

Auto Area Adjust.:

Sets whether to automatically correct the area setting of the camera using information from a linked smartphone.

Icons displayed when obtaining the location information

 (Obtaining location information): The camera is obtaining the location information.

 (Location information cannot be obtained): The camera cannot obtain the location information.

 (Bluetooth connection available): Bluetooth connection with the smartphone is established.

 (Bluetooth connection unavailable): Bluetooth connection with the smartphone is not established.

Hint

- Location information can be linked when Imaging Edge Mobile is running on your smartphone even if the smartphone monitor is off. However, if the camera has been turned off for a while, location information may not be linked immediately when you turn the camera back on. In this case, location information will be linked immediately if you open the Imaging Edge Mobile screen on the smartphone.
- When Imaging Edge Mobile is not operating, such as when the smartphone is restarted, launch Imaging Edge Mobile to resume location information linking.
- If the location information linking function does not work properly, see the following notes and perform pairing again.
 - Confirm that the Bluetooth function of your smartphone is activated.
 - Delete the pairing information for the camera registered in the smartphone's Bluetooth settings.
 - Confirm that the camera is not connected with other devices using the Bluetooth function.
 - Confirm that [Airplane Mode] for the camera is set to [Off].
 - Delete the pairing information for the camera registered in Imaging Edge Mobile.
 - Execute [Reset Network Set.] of the camera.
- For more detailed instructions, refer to the following support page.
<https://www.sony.net/iem/btg/>

Note

- When you initialize the camera, the pairing information is also deleted. Before performing pairing again, first delete the pairing information for the camera registered in the smartphone's Bluetooth settings and Imaging Edge Mobile.
- The location information will not be recorded when it cannot be obtained, such as when the Bluetooth connection is disconnected.
- The camera can be paired with up to 15 Bluetooth devices, but can link the location information with that of only one smartphone. If you want to link the location information with that of another smartphone, turn off the [Location Information Linkage] function of the smartphone that is already linked.
- If the Bluetooth connection is unstable, remove any obstacles, such as people or metal objects from between the camera and the paired smartphone.
- When pairing the camera and your smartphone, be sure to use the [Location Information Linkage] menu on Imaging Edge Mobile.
- To use the location information linkage function, set [Bluetooth Rmt Ctrl] to [Off].
- The communication distance for Bluetooth or Wi-Fi may vary depending on the conditions of use.

Supported smartphones

Refer to the support page for the latest information.

<https://www.sony.net/iem/>

- For details on Bluetooth versions compatible with your smartphone, check the product website for your smartphone.
-



Related Topic

- [Imaging Edge Mobile](#)
- [Send to Smartphone Func.: Send to Smartphone](#)
- [Bluetooth Settings](#)
- [Bluetooth Rmt Ctrl](#)

5-016-934-11(1) Copyright 2020 Sony Corporation

Bluetooth Rmt Ctrl

You can operate the camera using a Bluetooth remote commander (sold separately). For details on compatible remote commander, visit the Sony web site in your area, or consult your Sony dealer or local authorized Sony service facility. Select MENU →  (Network) → [Bluetooth Settings] → [Bluetooth Function] → [On] in advance. Refer to the instruction manual for the Bluetooth remote commander as well.

- 1 On the camera, select MENU →  (Network) → [Bluetooth Rmt Ctrl] → [On].**
 - If there is no Bluetooth device currently paired with the camera, the screen for pairing as described in Step 2 will appear.
- 2 On the camera, select MENU →  (Network) → [Bluetooth Settings] → [Pairing] to display the screen for pairing.**
- 3 On the Bluetooth remote commander, perform pairing.**
 - For details, refer to the instruction manual for the Bluetooth remote commander.
- 4 On the camera, select [OK] on the confirmation screen for the Bluetooth connection.**
 - Pairing is complete, and you can now operate the camera from the Bluetooth remote commander. After pairing the device once, you can connect the camera and the Bluetooth remote commander again in the future by setting [Bluetooth Rmt Ctrl] to [On].

Menu item details

On:

Enables Bluetooth remote commander operation.

Off:

Disables Bluetooth remote commander operation.

Hint

- The Bluetooth connection is only active while you are operating the camera using the Bluetooth remote commander.
- If the function does not work properly, check the following notes and then try pairing again.
 - Confirm that the camera is not connected with other devices using the Bluetooth function.
 - Confirm that [Airplane Mode] for the camera is set to [Off].
 - Execute [Reset Network Set.] of the camera.

Note

- When you initialize the camera, the pairing information is also deleted. To use the Bluetooth remote commander, perform pairing again.
- If the Bluetooth connection is unstable, remove any obstacles, such as people or metal objects from between the camera and the paired Bluetooth remote commander.
- You cannot use the function for linking location information with a smartphone while [Bluetooth Rmt Ctrl] is set to [On].
- While [Bluetooth Rmt Ctrl] is set to [On], the camera will not switch to the power-saving mode. Change the setting to [Off] when you are done using the Bluetooth remote commander.

Related Topic

- [Bluetooth Settings](#)

5-016-934-11(1) Copyright 2020 Sony Corporation

View on TV

You can view images on a network-enabled TV by transferring them from the product without connecting the product and TV with a cable. For some TVs, you may need to perform operations on the TV. For details, refer to the operating instructions supplied with the TV.

1 MENU →  (Network) → [View on TV] → **desired device to be connected.**

2 When you want to play back images using slideshow, press the center of the control wheel.

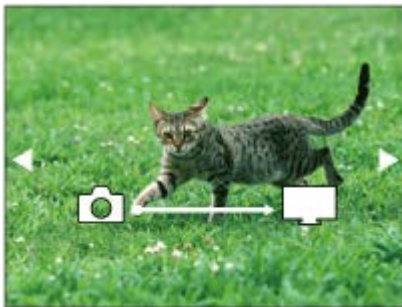

- To display the next/previous image manually, press the right/left sides of the control wheel.
- To change the device to be connected, press the down side of the control wheel, then select [Device list].

Slideshow settings

You can change the slideshow settings by pressing the down side of the control wheel.

Playback Selection:

Selects the group of images to be shown.

Folder View(Still):

Selects from [All] and [All in Folder].

Date View:

Selects from [All] and [All with this date].

Interval:

Selects from [Short] and [Long].

Effects*:

Selects from [On] and [Off].

Playback Image Size:

Selects from [HD] and [4K].

* The settings are effective only for BRAVIA TV which is compatible with the functions.

Note

- You can use this function on a TV that supports DLNA renderer.
- You can view images on a Wi-Fi Direct-enabled TV or network-enabled TV (including wired network-enabled TVs).
- If you connect TV and this product and do not use Wi-Fi Direct, you need to register your access point first.
- Displaying the images on the TV may take time.
- Movies cannot be shown on a TV via Wi-Fi. Use an HDMI cable (sold separately).
- When [Display as Group] is set to [On], only the first image of the group is transferred to the TV.

Related Topic

- [Wi-Fi Settings: WPS Push](#)
- [Wi-Fi Settings: Access Point Set.](#)

5-016-934-11(1) Copyright 2020 Sony Corporation

Digital Camera
ZV-1

Airplane Mode

When you board an airplane, etc., you can temporarily disable all the wireless-related functions including Wi-Fi.

1 MENU →  (Network) → [Airplane Mode] → **desired setting.**

If you set [Airplane Mode] to [On], an airplane mark will be displayed on the screen.

Wi-Fi Settings: WPS Push

If your access point has a Wi-Fi Protected Setup (WPS) button, you can register the access point to this product easily.

- 1 MENU →  (Network) → [Wi-Fi Settings] → [WPS Push].
- 2 Push the Wi-Fi Protected Setup (WPS) button on the access point to connect.

Note

- [WPS Push] works only if the security setting of your access point is set to WPA or WPA2 and your access point supports the Wi-Fi Protected Setup (WPS) button method. If the security setting is set to WEP or your access point does not support the Wi-Fi Protected Setup (WPS) button method, perform [Access Point Set].
- For details about the available functions and settings of your access point, see the access point operating instructions or contact the administrator of the access point.
- A connection may not be possible or the communication distance may be shorter depending on the surrounding conditions, such as the type of wall material and the presence of obstructions or radio waves between the product and access point. In this case, change the location of the product or move the product closer to the access point.

Related Topic

- [Wi-Fi Settings: Access Point Set.](#)

Wi-Fi Settings: Access Point Set.

You can register your access point manually. Before starting the procedure, check the SSID name of the access point, security system, and password. The password may be preset in some devices. For details, see the access point operating instructions, or consult the access point administrator.

1 MENU →  (Network) → [Wi-Fi Settings] → [Access Point Set.].

2 Select the access point you want to register.

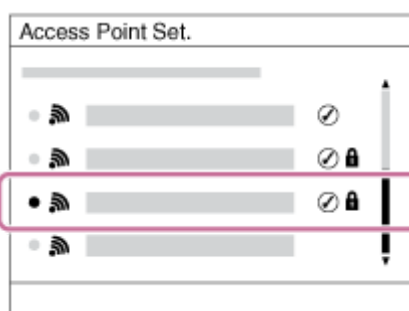

When the desired access point is displayed on the screen: Select the desired access point.

When the desired access point is not displayed on the screen: Select [Manual Setting] and set the access point.

- If you select [Manual Setting], input the SSID name of the access point, then select the security system.

3 Input the password, and select [OK].

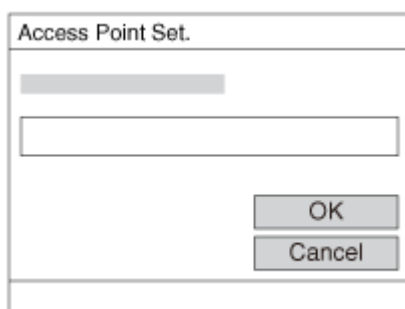

- Access points without the  (lock) mark do not require a password.

4 Select [OK].

Other setting items

Depending on the status or the setting method of your access point, you may want to set more items.

WPS PIN:

Displays the PIN code you enter into the connected device.

Priority Connection:

Select [On] or [Off].

IP Address Setting:

Select [Auto] or [Manual].

IP Address:

If you are entering the IP address manually, enter the set address.

Subnet Mask/Default Gateway:

If you have set [IP Address Setting] to [Manual], enter each address according to your network environment.

Note

- To give the registered access point priority in the future, set [Priority Connection] to [On].

Related Topic

- [Wi-Fi Settings: WPS Push](#)
- [How to use the keyboard](#)

Digital Camera
ZV-1

Wi-Fi Settings: Display Wi-Fi Info.

Displays Wi-Fi information for the camera such as the MAC address, IP address, etc.

1 MENU →  (Network) → [Wi-Fi Settings] → [Display Wi-Fi Info.].

Digital Camera
ZV-1

Wi-Fi Settings: SSID/PW Reset

This product shares connection information for [Send to Smartphone] and [Connection] under [Ctrl w/ Smartphone] with devices that have permission to connect. If you want to change the devices that are permitted to connect, reset the connection information.

1 MENU →  (Network) → [Wi-Fi Settings] → [SSID/PW Reset] → [OK].

Note

- If you connect this product to a smartphone after resetting the connection information, you must make the settings for the smartphone again.

Related Topic

- [Send to Smartphone Func.: Send to Smartphone](#)
- [Ctrl w/ Smartphone](#)

Digital Camera
ZV-1

Bluetooth Settings

Controls the settings for connecting the camera to a smartphone or Bluetooth remote commander via a Bluetooth connection.

If you want to pair the camera and smartphone in order to use the location information link function, refer to “Location Info. Link Set..”

If you want to perform pairing in order to use a Bluetooth remote commander, refer to “Bluetooth Rmt Ctrl.”

1 MENU →  (Network) → [Bluetooth Settings] → desired setting.

Menu item details

Bluetooth Function (On/Off):

Sets whether to activate or not the Bluetooth function of the camera.

Pairing:

Displays the screen for pairing the camera and smartphone or Bluetooth remote commander.

Disp Device Address:

Displays the BD address of the camera.

Related Topic

- [Location Info. Link Set.](#)
- [Bluetooth Rmt Ctrl](#)

Digital Camera
ZV-1

Edit Device Name

You can change the device name for Wi-Fi Direct, [PC Remote], or Bluetooth connections.

- 1** MENU →  (Network) → [Edit Device Name].
 - 2** Select the input box, then input the device name → [OK].
-

Related Topic

- [Wi-Fi Settings: WPS Push](#)
- [Wi-Fi Settings: Access Point Set.](#)
- [Operating the camera from a computer \(PC Remote Function\)](#)
- [How to use the keyboard](#)

Digital Camera
ZV-1

Reset Network Set.

Resets all the network settings to default settings.

1 MENU →  (Network) → [Reset Network Set.] → [Enter].

Digital Camera
ZV-1

Recommended computer environment

You can confirm the operating computer environment of the software from the following URL:

<https://www.sony.net/pcenv/>

Connecting to a computer

- 1 Insert a sufficiently charged battery pack into the camera.
- 2 Turn on the camera and the computer.
- 3 Check that [USB Connection] under  (Setup) is set to [Mass Storage].
- 4 Connect the camera to the computer using the micro USB cable (supplied).
 - Connect the micro USB cable to the Multi/Micro USB Terminal on the camera.
 - When you connect the camera to the computer for the first time, the procedure for recognizing the camera may start automatically on the computer. Wait until the procedure is finished.
 - If you connect the product to your computer using the micro USB cable when [USB Power Supply] is set to [On], power is supplied from your computer. (Default setting: [On])
 - Use the supplied USB cable or a cable that is compliant with the USB standard.

Note

- Do not turn on/off or restart the computer, or wake the computer from sleep mode when a USB connection has been established between the computer and the camera. Doing so may cause a malfunction. Before turning on/off or restarting the computer, or waking the computer from sleep mode, disconnect the camera from the computer.

Related Topic

- [Identifying parts](#)
- [USB Connection](#)
- [USB LUN Setting](#)

Disconnecting the camera from the computer

Perform steps 1 and 2 below before performing the following operations:

- Disconnecting the micro USB cable.
- Removing a memory card.
- Turning off the product.

1 Click  (Safely Remove Hardware and Eject Media) in the taskbar.

2 Click the displayed message.

Note

- On Mac computers, drag and drop the memory card icon or the drive icon into the “Trash” icon. The camera will be disconnected from the computer.
- On some computers, the disconnection icon may not appear. In this case, you can skip the steps above.
- Do not remove the micro USB cable from the camera while the access lamp is lit. The data may be damaged.

Digital Camera
ZV-1

Introduction to computer software (PlayMemories Home/Imaging Edge)

PlayMemories Home

PlayMemories Home is software for Windows, and includes functions for managing, editing, and sharing your still images and movies.

For details on how to use PlayMemories Home, refer to the support page.

<https://www.sony.co.jp/pmh-se/>

Installing PlayMemories Home on your computer

Download and install the software by accessing the following URL:

<https://www.sony.net/pm/>

Imaging Edge

Imaging Edge is a software suite that includes functions such as remote shooting from a computer, and adjusting or developing RAW images recorded with the camera.

For details on how to use Imaging Edge, refer to the support page.

<https://www.sony.net/disoft/help/>

Installing Imaging Edge on your computer

Download and install the software by accessing the following URL:

<https://www.sony.net/disoft/d/>

Importing images to the computer without using computer software

Importing images to the Windows computer

When the AutoPlay Wizard appears after making a USB connection between this product and a computer, click [Open folder to view files] → [OK] → [DCIM]. Then copy the desired images to the computer.

Importing images to the Mac computer

Connect the product to your Mac computer. Double-click the newly recognized icon on the desktop → the folder in which the image you want to import is stored. Then drag and drop the image file on to the hard disk icon.

Note

- For operations such as importing XAVC S movies or AVCHD movies to the computer, use PlayMemories Home. (Windows only)
- Do not edit or otherwise process AVCHD or XAVC S movie files/folders from the connected computer. Movie files may be damaged or become unplayable. Do not delete or copy AVCHD movies or XAVC S movies on the memory card from the computer. Sony is not held liable for consequences resulting from such operations via the computer.
- If you delete images or perform other operations from the connected computer, the image database file may become inconsistent. In this case, repair the image database file.

Digital Camera
ZV-1

Send to Computer

You can transfer images stored in the product to a computer connected to a wireless access point or wireless broadband router and easily make backup copies using this operation. Before starting this operation, install PlayMemories Home on your computer and register the access point on the product.

- 1 **Start your computer.**
- 2 **MENU** →  **(Network)** → **[Send to Computer]**.

Note

- Depending on the application settings of your computer, the product will turn off after saving the images to your computer.
- You can transfer images from the product to only one computer at a time.
- If you want to transfer images to another computer, connect the product and the computer via a USB connection and follow the instructions in PlayMemories Home.
- Proxy movies cannot be transferred.

Related Topic

- [Introduction to computer software \(PlayMemories Home/Imaging Edge\)](#)
- [Wi-Fi Settings: WPS Push](#)
- [Wi-Fi Settings: Access Point Set.](#)

Operating the camera from a computer (PC Remote Function)

With a USB connection, you can control the camera from a computer, including such functions as shooting and storing images on the computer.

Select MENU →  (Network) → [Ctrl w/ Smartphone] → [Ctrl w/ Smartphone] → [Off] beforehand.

- 1 MENU →  (Network) → [PC Remote Function] → Select an item to set, and then select the desired setting.**
- 2 Connect the camera to the computer using the micro USB cable (supplied), and then launch Imaging Edge (Remote) on the computer.**

You can now operate the camera using Imaging Edge (Remote).

Menu item details

PC Remote:

Sets whether or not to use the [PC Remote] function. ([On] / [Off])

Still Img. Save Dest.:

Sets whether or not to save still images to both the camera and the computer during PC Remote shooting. ([PC Only]/[PC+Camera]/[Camera Only])

RAW+J PC Save Img:

Selects the file type for images to be transferred to the computer when [Still Img. Save Dest.] is set to [PC+Camera]. ([RAW & JPEG]/[JPEG Only]/[RAW Only])

Note

- When an unrecordable memory card is inserted into the camera, you cannot record still images even if [Still Img. Save Dest.] is set to [Camera Only] or [PC+Camera].
- When [Camera Only] or [PC+Camera] is selected and no memory card is inserted into the camera, the shutter will not be released even if [Release w/o Card] is set to [Enable].
- While a still image is being played back on the camera, you cannot shoot with [PC Remote].
- [RAW+J PC Save Img] can only be selected when [ File Format] is set to [RAW & JPEG].

Related Topic

- [Introduction to computer software \(PlayMemories Home/Imaging Edge\)](#)

Using MENU items

You can change settings related to all the camera operations including shooting, playback, and operating method. You can also execute camera functions from the MENU.

- 1 Press the MENU button to display the menu screen.

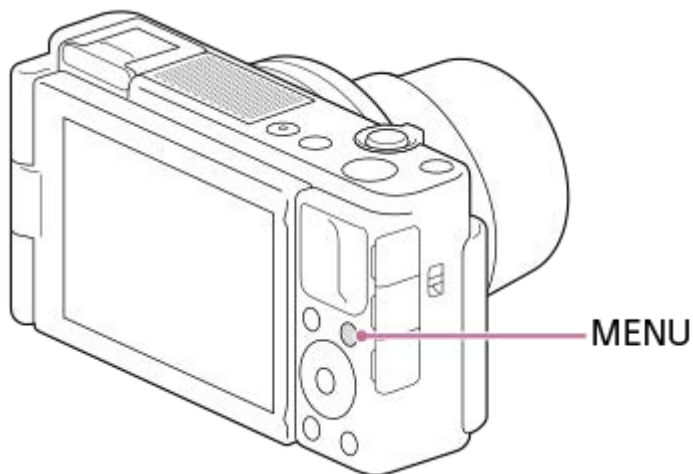

- 2 Select the desired setting you want to adjust using the top/bottom/left/right sides of the control wheel or by turning the control wheel, and then press the center of the control wheel.

- Select a MENU tab (A) at the top of the screen, and press the left/right side of the control wheel to move to another MENU tab.
- You can move to the next MENU tab by pressing the Fn button.
- You can go back to the previous screen by pressing the MENU button.



- 3 Select the desired setting value, and press the center to confirm your selection.



Related Topic

- [Tile Menu](#)
- [Add Item](#)
- [Display From My Menu](#)

Digital Camera
ZV-1

File Format (still image)

Sets the file format for still images.

1 MENU →  (Camera Settings1) → [ File Format] → desired setting.

Menu item details

RAW:

Digital processing is not performed on this file format. Select this format to process images on a computer for professional purposes.

RAW & JPEG:

A RAW image and a JPEG image are created at the same time. This is suitable when you need two image files, a JPEG for viewing, and a RAW for editing.

JPEG:

The image is recorded in the JPEG format.

About RAW images

- To open a RAW image file recorded with this camera, the software Imaging Edge is needed. With Imaging Edge, you can open a RAW image file, then convert it into a popular image format such as JPEG or TIFF, or readjust the white balance, saturation or contrast of the image.
- You cannot apply [Auto HDR] or [Picture Effect] functions with RAW images.
- RAW images shot by the camera are recorded in the compressed RAW format.

Note

- If you do not intend to edit the images on your computer, we recommend that you record in JPEG format.
- You cannot add DPOF (print order) registration marks to RAW images.



Related Topic

- [JPEG Quality \(still image\)](#)

Digital Camera
ZV-1

JPEG Quality (still image)

Selects the JPEG image quality when [ File Format] is set to [RAW & JPEG] or [JPEG].

1 MENU →  (Camera Settings1) → [ JPEG Quality] → **desired setting.**

Menu item details

Extra fine/Fine/Standard:

Since the compression rate increases from [Extra fine] to [Fine] to [Standard], the file size decreases in the same order. This allows more files to be recorded on one memory card, but the image quality is lower.



Related Topic

- [File Format \(still image\)](#)

Digital Camera
ZV-1

JPEG Image Size (still image)

The larger the image size, the more detail will be reproduced when the image is printed on large-format paper. The smaller the image size, the more images can be recorded.

1 MENU →  (Camera Settings1) → [ JPEG Image Size] → desired setting.

Menu item details

When [ Aspect Ratio] is set to 3:2

Parameter	Number of pixels (horizontal × vertical)
L: 20M	5472×3648 pixels
M: 10M	3888×2592 pixels
S: 5.0M	2736×1824 pixels

When [ Aspect Ratio] is set to 4:3

Parameter	Number of pixels (horizontal × vertical)
L: 18M	4864×3648 pixels
M: 10M	3648×2736 pixels
S: 5.0M	2592×1944 pixels
VGA	640×480 pixels

When [ Aspect Ratio] is set to 16:9

Parameter	Number of pixels (horizontal × vertical)
L: 17M	5472×3080 pixels
M: 7.5M	3648×2056 pixels
S: 4.2M	2720×1528 pixels

When [ Aspect Ratio] is set to 1:1

Parameter	Number of pixels (horizontal × vertical)
L: 13M	3648×3648 pixels
M: 6.5M	2544×2544 pixels
S: 3.7M	1920×1920 pixels

Note

- When [ File Format] is set to [RAW] or [RAW & JPEG], the image size for RAW images corresponds to “L.”



Related Topic

- [Aspect Ratio \(still image\)](#)

5-016-934-11(1) Copyright 2020 Sony Corporation

Digital Camera
ZV-1

Aspect Ratio (still image)

① MENU →  1 (Camera Settings1) → [ Aspect Ratio] → desired setting.

Menu item details

3:2:

Same aspect ratio as 35 mm film

4:3:

The aspect ratio is 4:3.

16:9:

The aspect ratio is 16:9.

1:1:

The horizontal and vertical ratio is equal.

Digital Camera
ZV-1

Panorama: Size

Sets the image size when shooting panoramic images. The image size varies depending on the [Panorama: Direction] setting.

1 MENU →  (Camera Settings1) → [Panorama: Size] → desired setting.

Menu item details

When [Panorama: Direction] is set to [Up] or [Down]

Standard: 3872×2160

Wide: 5536×2160

When [Panorama: Direction] is set to [Left] or [Right]

Standard: 8192×1856

Wide: 12416×1856

Related Topic

- [Sweep Panorama](#)
- [Panorama: Direction](#)

Digital Camera
ZV-1

Panorama: Direction

Sets the direction to pan the camera when shooting panoramic images.

1 MENU →  1 (Camera Settings1) → [Panorama: Direction] → desired setting.

Menu item details

Right:

Pan the camera from the left to the right.

Left:

Pan the camera from the right to the left.

Up:

Pan the camera from the bottom to the top.

Down:

Pan the camera from the top to the bottom.



Related Topic

- [Sweep Panorama](#)

Digital Camera
ZV-1

Long Exposure NR (still image)

When you set the shutter speed to 1/3 second(s) or longer (long exposure shooting), noise reduction is turned on for the duration that the shutter is open. With the function turned on, the grainy noise typical of long exposures is reduced.

1 MENU →  (Camera Settings1) → [ Long Exposure NR] → desired setting.

Menu item details





On:

Activates noise reduction for the same duration that the shutter is open. When noise reduction is in progress, a message appears and you cannot take another picture. Select this to prioritize the image quality.

Off:

Does not activate noise reduction. Select this to prioritize the timing of shooting.



Note

- [ Long Exposure NR] is not available when [ Shutter Type] is set to [Electronic Shutter].
- Noise reduction may not be activated even if [ Long Exposure NR] is set to [On] in the following situations:
 - The shooting mode is set to [Sweep Panorama].
 - [Drive Mode] is set to [Cont. Shooting], [Cont. Bracket], or [Self-timer(Cont)].
 - The shooting mode is set to [Scene Selection] and [Sports Action], [Hand-held Twilight] or [Anti Motion Blur] is selected.
 - The ISO sensitivity is set to [Multi Frame NR].
- [ Long Exposure NR] cannot be set to [Off] in the following shooting modes:
 - [Intelligent Auto]
 - [Scene Selection]
- Depending on the shooting conditions, the camera may not perform noise reduction, even if the shutter speed is 1/3 second(s) or longer.

Digital Camera
ZV-1

High ISO NR (still image)

When shooting with high ISO sensitivity, the product reduces noise that becomes more noticeable when the product sensitivity is high.

1 MENU →  1 (Camera Settings1) → [ High ISO NR] → desired setting.

Menu item details

Normal:

Activates high ISO noise reduction normally.





Low:

Activates high ISO noise reduction moderately.

Off:

Does not activate high ISO noise reduction. Select this to prioritize the timing of shooting.



Note

- [ High ISO NR] is fixed to [Normal] in the following shooting modes:
 - [Intelligent Auto]
 - [Scene Selection]
 - [Sweep Panorama]
- When [ File Format] is set to [RAW], this function is not available.
- [ High ISO NR] does not work for RAW images when the [ File Format] is [RAW & JPEG].

Digital Camera
ZV-1

Color Space (still image)

The way colors are represented using combinations of numbers or the range of color reproduction is called “color space.” You can change the color space depending on the purpose of the image.

1 MENU →  (Camera Settings1) → [ Color Space] → desired setting.

Menu item details

sRGB:

This is the standard color space of the digital camera. Use [sRGB] in normal shooting, such as when you intend to print out the images without any modification.

AdobeRGB:

This color space has a wide range of color reproduction. When a large part of the subject is vivid green or red, Adobe RGB is effective. The file name of the recorded image starts with “_.”

Note

- [AdobeRGB] is for applications or printers that support color management and DCF2.0 option color space. Images may not be printed or viewed in the correct colors if you use applications or printers that do not support Adobe RGB.
- When displaying images that were recorded with [AdobeRGB] on non-Adobe RGB-compliant devices, the images will be displayed with low saturation.

Changing shooting modes (Shoot Mode)

You can set the shooting mode according to the subject you wish to shoot or the function you wish to adjust.

- 1 Press the **MODE (Mode)** button, and then use the control wheel to select the desired shooting mode.

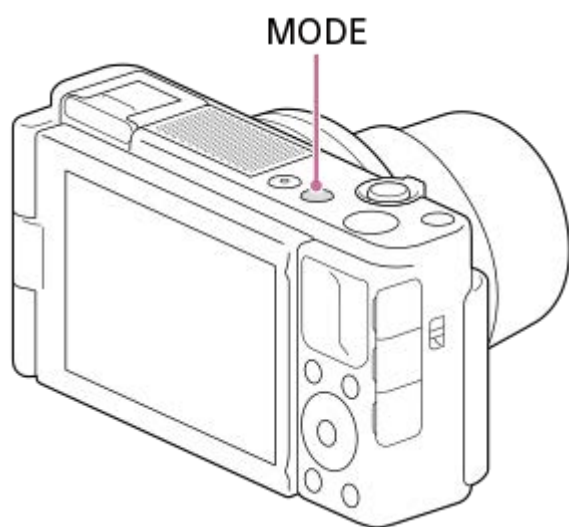

- You can also set the shooting mode by selecting MENU → 1 (Camera Settings1) → [Shoot Mode].

Available functions

(Intelligent Auto):

Allows you to shoot with automatic scene recognition.

P (Program Auto):

Allows you to shoot with the exposure adjusted automatically (both the shutter speed and the aperture value (F value)). Also you can select various settings using the menu.

A (Aperture Priority):

Allows you to adjust the aperture and shoot when you want to blur the background, etc.

S (Shutter Priority):

Allows you to shoot fast-moving subjects etc., by manually adjusting the shutter speed.

M (Manual Exposure):

Allows you to shoot still images with the desired exposure by adjusting the exposure (both the shutter speed and the aperture value (F value)).

(Sweep Panorama):

Allows you to shoot a panoramic image by compositing the images.

SCN (Scene Selection):

Allows you to shoot with preset settings according to the scene.

MR (Memory recall):

Allows you to shoot an image after recalling often-used modes or numeric settings registered in advance.

HFR (High Frame Rate):

Allows you to shoot movies with a higher frame rate than the recording format so that you can record smooth super-slow-motion movies.

(Movie):

Allows you to change the exposure mode for movie recording.

(Intelligent Auto):

Allows you to record movies with automatic scene recognition.

Related Topic

- [Intelligent Auto](#)
- [Program Auto](#)
- [Aperture Priority](#)
- [Shutter Priority](#)
- [Manual Exposure](#)
- [Sweep Panorama](#)
- [Scene Selection](#)
- [Recall \(Camera Settings1/Camera Settings2\)](#)
- [Shooting super-slow-motion movies \(HFR Settings\)](#)
- [HFR \(High Frame Rate\): Exposure Mode](#)
- [Movie: Exposure Mode](#)
- [Intelligent Auto \(movie\)](#)

Intelligent Auto

The camera shoots with automatic scene recognition.

1 **MODE (Mode) button** → **[Intelligent Auto]** → **press the center of the control wheel.**

- You can also set the shooting mode by selecting MENU →  1 (Camera Settings1) → [Shoot Mode].

2 **Point the camera at the subject.**

When the camera recognized the scene, the icon for the recognized scene appears on the screen.



3 **Adjust the focus and shoot the image.**

Note

- The product will not recognize the scene when you shoot images with zoom functions other than optical zoom.
- The product may not properly recognize the scene under certain shooting conditions.
- For [Intelligent Auto] mode, most of the functions are set automatically, and you cannot adjust the settings on your own.

Related Topic

- [About Scene Recognition](#)

Scene Selection

Allows you to shoot with preset settings according to the scene.

- 1 MODE (Mode) button → [Scene Selection] → press the center of the control wheel.**
 - You can also set the shooting mode by selecting MENU →  1 (Camera Settings1) → [Shoot Mode].
- 2 Turn the control wheel to select the desired setting.**

Menu item details

Portrait:

Blurs background and sharpens the subject. Accentuates the skin tones softly.



Sports Action:

Shoots a moving subject at a fast shutter speed so that the subject looks as if it is standing still. The product shoots images continuously while the shutter button is pressed.



Macro:

Shoots close-ups of the subjects, such as flowers, insects, food, or small items.



Landscape:

Shoots the entire range of a scenery in sharp focus with vivid colors.



Sunset:

Shoots the red of the sunset beautifully.



🌙 Night Scene:

Shoots night scenes without losing the dark atmosphere.



👋 Hand-held Twilight:

Shoots night scenes with less noise and blur without using a tripod. A burst of shots are taken, and image processing is applied to reduce subject blur, camera-shake, and noise.



👤🌙 Night Portrait:

Shoots night scene portraits using the flash (sold separately).



👤👤 Anti Motion Blur:

Allows you to shoot indoor shots without using the flash and reduces subject blur. The product shoots burst images and combines them to create the image, reducing subject blur and noise.



🐱 Pet:

Allows you to shoot images of your pet with the best settings.



🍴 Gourmet:

Allows you to shoot food arrangements in delicious and bright colors.



Fireworks:

Allows you to shoot images of fireworks in all their splendor.



High Sensitivity:

Allows you to shoot still images even in dark locations without using the flash, and reduces subject blur. Also allows you to shoot dark movie scenes more brightly.



Hint

- To change the scene, rotate the control wheel on the shooting screen and select a new scene.

Note



- Under the following settings, the shutter speed is slower, so use of a tripod, etc. is recommended to prevent the image from blurring:
 - [Night Scene]
 - [Night Portrait]
 - [Fireworks]
- In the [Hand-held Twilight] or [Anti Motion Blur] mode, the shutter clicks 4 times and an image is recorded.
- If you select [Hand-held Twilight] or [Anti Motion Blur] with [RAW] or [RAW & JPEG], [ File Format] becomes [JPEG] temporarily.
- Reducing blur is less effective even in [Hand-held Twilight] or [Anti Motion Blur] when shooting the following subjects:
 - Subjects with erratic movement.
 - Subjects that are too close to the product.
 - Subjects with continuously similar patterns, such as the sky, a beach, or a lawn.
 - Subjects with constant change such as waves or water falls.
- In the case of [Hand-held Twilight] or [Anti Motion Blur], block noise may occur when using a light source that flickers, such as fluorescent lighting.
- The minimum distance that you can come close to a subject does not change even if you select [Macro]. For the minimum in-focus range, refer to the minimum distance of the lens.
- [Product Showcase Set] and [Background Defocus] are unavailable when the shooting mode is set to [Scene Selection].

Related Topic

- [Using flash \(sold separately\)](#)

Drive Mode

Select the appropriate mode for the subject, such as single shooting, continuous shooting or bracketing shooting.

- 1 Select  (Drive Mode) on the control wheel → desired setting.
 - You can also set the drive mode by selecting MENU →  1 (Camera Settings1) → [Drive Mode].
- 2 Select the desired mode using the right/left side of the control wheel.

Menu item details

Single Shooting :

Normal shooting mode.

Cont. Shooting :

Shoots images continuously while you press and hold down the shutter button.

Self-timer :

Shoots an image using the self-timer after a designated number of seconds have elapsed since the shutter button was pressed.

Self-timer(Cont) :

Shoots a designated number of images using the self-timer after a designated number of seconds have elapsed since the shutter button was pressed.

Cont. Bracket :

Shoots images while holding the shutter button down, each with different degrees of exposure.

Single Bracket :

Shoots a specified number of images, one by one, each with a different degrees of exposure.

WB bracket :

Shoots a total of three images, each with different color tones according to the selected settings for white balance, color temperature and color filter.

DRO Bracket :

Shoots a total of three images, each at a different degree of D-Range Optimizer.

Note





- When the shooting mode is set to [Scene Selection] and [Sports Action] is selected, [Single Shooting] cannot be performed.

Related Topic

- [Cont. Shooting](#)
- [Self-timer](#)
- [Self-timer\(Cont\)](#)
- [Cont. Bracket](#)
- [Single Bracket](#)
- [WB bracket](#)
- [DRO Bracket](#)

Bracket Settings

You can set the self-timer in bracket shooting mode, and the shooting order for exposure bracketing and white balance bracketing.

- 1 Select  /  (Drive Mode) of the control wheel → select bracket shooting mode.
 - You can also set the drive mode by selecting MENU →  1 (Camera Settings1) → [Drive Mode].
- 2 MENU →  1 (Camera Settings1) → [Bracket Settings] → desired setting.

Menu item details

Selftimer during Bracket:

Sets whether to use the self-timer during bracket shooting. Also sets the number of seconds until the shutter is released if using the self-timer.

(OFF/2 Sec/5 Sec/10 Sec)

Bracket order:

Sets the order of exposure bracketing and white balance bracketing.

(0→-→+/-→0→+)

Related Topic





- [Cont. Bracket](#)
- [Single Bracket](#)
- [WB bracket](#)
- [DRO Bracket](#)

Interval Shoot Func.

You can automatically shoot a series of still images with the shooting interval and number of shots that you set in advance (Interval shooting). You can then create a movie from the still images produced by interval shooting using the computer software Imaging Edge (Viewer). You cannot create a movie from the still images on the camera.

For details on interval shooting, refer to the following URL:

<https://support.d-imaging.sony.co.jp/support/tutorial/dc/zv-1//interval.php>

- 1 **MENU** →  1 (Camera Settings1) → [ Interval Shoot Func.] → [Interval Shooting] → [On].
- 2 **MENU** →  1 (Camera Settings1) → [ Interval Shoot Func.] → Select the item you want to set and the desired setting.
- 3 **Press the shutter button.**
When the time set for [Shooting Start Time] has elapsed, shooting will start.
 - When the number of shots set for [Number of Shots] is completed, the camera will return to the standby screen for interval shooting.

Menu item details

Interval Shooting:

Sets whether to perform interval shooting. ([On]/[Off])

Shooting Start Time:

Sets the time from when you press the shutter button to when interval shooting starts. (1 second to 99 minutes 59 seconds)

Shooting Interval:

Sets the shooting interval (time from when one exposure starts to when the exposure for the next shot starts). (1 second to 60 seconds)

Number of Shots:

Sets the number of shots for interval shooting. (1 shot to 9999 shots)

AE Tracking Sensitivity:

Sets the tracking sensitivity of the auto exposure against the change in luminance during interval shooting. If you select [Low], exposure changes during interval shooting will be smoother. ([High]/[Mid]/[Low])



Shutter Type in Interval:

Sets the shutter type during interval shooting. ([Mechanical Shutter]/[Electronic Shutter])

Shoot Interval Priority:

Sets whether or not to prioritize the shooting interval when the exposure mode is [Program Auto] or [Aperture Priority] and the shutter speed becomes longer than the time set for [Shooting Interval]. ([On]/[Off])

Hint

- If you press the shutter button during interval shooting, interval shooting will end and the camera will return to the standby screen for interval shooting.
- To go back to the normal shooting mode, select MENU →  1 (Camera Settings1) → [ Interval Shoot Func.] → [Interval Shooting] → [Off].
- If you press a key to which one of the following functions has been assigned at the moment when shooting starts, the function will remain active during interval shooting even without you holding down the button.

- [AEL hold]
- [ AEL hold]
- [AF/MF Control Hold]

- If you set [Display as Group] to [On], still images shot with the interval shooting function will be displayed in groups.
- Still images shot with interval shooting can be played back continuously on the camera. If you intend to create a movie using the still images, you can preview the result.



Note





- You may not be able to record the set number of images depending on the remaining battery level and the amount of free space on the recording medium. Supply power via USB while shooting, and use a memory card with sufficient space.
- When the shooting interval is short, the camera may get hot easily. Depending on the ambient temperature, you may not be able to record the set number of images because the camera may stop recording to protect the equipment.
- During interval shooting (including the time between pressing the shutter button and the start of shooting), you cannot operate the dedicated shooting setting screen or MENU screen. However, you can adjust some settings assigned to the control wheel, such as the shutter speed.
- During interval shooting, auto review is not displayed.
- [Shutter Type in Interval] is set to [Electronic Shutter] as a default, regardless of the setting for [ Shutter Type].
- Interval shooting is unavailable in the following situations:
 - The shooting mode is set to other than P/A/S/M
- Selectable shutter speeds may differ depending on the setting for [Shutter Type in Interval].

Related Topic

- [Introduction to computer software \(PlayMemories Home/Imaging Edge\)](#)
- [Cont. PB for Interval](#)
- [Supplying power from a wall outlet \(wall socket\)](#)

Recall (Camera Settings1/Camera Settings2)



Allows you to shoot an image after recalling often-used modes or camera settings registered with [**MR**   Memory] in advance.

- 1 MODE (Mode) button → [Memory recall] → press the center of the control wheel.**
 - You can also set the shooting mode by selecting MENU →  1 (Camera Settings1) → [Shoot Mode].
- 2 Press the left/right side of the control wheel or turn the control wheel to select the desired number, then press the center of the control wheel.**
 - You can also recall registered modes or settings by selecting MENU →  1 (Camera Settings1) → [**MR**   Recall].

Hint

- Settings registered to a memory card using another camera of the same model name can be recalled with this camera.

Note

- If you set [**MR**   Recall] after completing the shooting settings, the registered settings are given priority and the original settings may become invalid. Check the indicators on the screen before shooting.



Related Topic

- [Memory \(Camera Settings1/Camera Settings2\)](#)

Digital Camera
ZV-1

Memory (Camera Settings1/Camera Settings2)

Allows you to register up to 3 often-used modes or product settings to the product and up to 4 (M1 through M4) to the memory card. You can recall the settings using just the MODE (Mode) button.

- 1 Set the product to the setting you want to register.
- 2 MENU →  (Camera Settings1) → [MR  /  Memory] → desired number.
- 3 Press the center of the control wheel to confirm.

Items that can be registered

- You can register various functions for shooting. The items that can actually be registered are displayed on the menu of the camera.
- Aperture (F number)
- Shutter speed
- Optical zoom scale

To change registered settings

Change the setting to the desired one and re-register the setting to the same mode number.

Note

- M1 through M4 can be selected only when a memory card is inserted into the product.
- Program Shift cannot be registered.

Related Topic

- [Recall \(Camera Settings1/Camera Settings2\)](#)

Digital Camera
ZV-1

Focus Mode

Selects the focus method to suit the movement of the subject.

1 MENU →  1 (Camera Settings1) → [Focus Mode] → desired setting.

Menu item details

AF-S (Single-shot AF):

The product locks the focus once focusing is complete. Use this when the subject is motionless.

AF-A (Automatic AF):

[Single-shot AF] and [Continuous AF] are switched according to the movement of the subject. When the shutter button is pressed halfway down, the product locks the focus when it determines that the subject is motionless, or continues to focus when the subject is in motion. During continuous shooting, the product automatically shoots with Continuous AF from the second shot.

AF-C (Continuous AF):

The product continues to focus while the shutter button is pressed and held halfway down. Use this when the subject is in motion. In [Continuous AF] mode, there is no beep when the camera focuses.

DMF (DMF):

You can make fine adjustments manually after performing auto focusing, letting you focus on a subject more quickly than when using the manual focus from the beginning. This is convenient in situations such as macro shooting.

MF (Manual Focus):

Adjusts the focus manually. If you cannot focus on the intended subject using auto focus, use manual focus.

Focus indicator

● (lit):

The subject is in focus and the focus is locked.

● (flashing):

The subject is not in focus.

⦿ (lit):

The subject is in focus. The focus will be adjusted continuously according to the movements of the subject.

⦿ (lit):

Focusing is in progress.

Subjects on which it is difficult to focus using auto focus

- Dark and distant subjects
- Subjects with poor contrast
- Subjects seen through glass
- Fast-moving subjects
- Reflective light or shiny surfaces
- Flashing light
- Back-lit subjects
- Continuously repetitive patterns, such as the facades of buildings
- Subjects in the focusing area with different focal distances

Hint

- When you set the focus to infinity in the manual focus mode or the direct manual focus mode, make sure that the focus is on a sufficiently distant subject by checking the monitor.

Note

- Only [Continuous AF] and [Manual Focus] are available when shooting movies or when the shooting mode is set to **HFR** (High Frame Rate).

Related Topic

- [Direct manual focus \(DMF\)](#)
- [Manual Focus \(Set Focus\)](#)
- [MF Assist \(still image\)](#)
- [Phase detection AF](#)

5-016-934-11(1) Copyright 2020 Sony Corporation

Focus Area

Selects the focusing area. Use this function when it is difficult to focus properly in the auto focus mode.

1 MENU →  (Camera Settings1) → [Focus Area] → desired setting.

Menu item details

Wide :

Focuses on a subject covering the whole range of the screen automatically. When you press the shutter button halfway down in the still image shooting mode, a green frame is displayed around the area that is in focus.

Zone :

Select a zone on the monitor on which to focus, and the product will automatically select a focus area.

Center :

Focuses automatically on a subject in the center of the image. Use together with the focus-lock function to create the composition you want.

Flexible Spot :

Allows you to move the focusing frame to a desired point on the screen and focus on an extremely small subject in a narrow area.

On the Flexible Spot shooting screen, you can change the size of the focusing frame by turning the control wheel.

Expand Flexible Spot :

If the product cannot focus on a single selected point, it uses focus points around the flexible spot as a secondary priority area for focusing.







Tracking:

When the shutter button is pressed and held halfway down, the product tracks the subject within the selected autofocus area. This setting is available only when the focus mode is set to [Continuous AF]. Point the cursor at [Tracking] on the [Focus Area] setting screen, and then select the desired area to start tracking using the left/right sides of the control wheel. You can also move the tracking start area to the desired point by designating the area as a zone, flexible spot or expand flexible spot. On the Flexible Spot shooting screen, you can change the size of the focusing frame by turning the control wheel.

To move the focus area

- When [Focus Area] is set to [Zone], [Flexible Spot] or [Expand Flexible Spot], if pressing the button to which [Focus Standard] is assigned, you can shoot while moving the focusing frame using the top/bottom/left/right sides of the control wheel. To return the focusing frame to the center of the monitor, press the  (Delete) button while moving the frame. To change the shooting settings using the control wheel, press the button to which [Focus Standard] is assigned.
- You can move the focusing frame quickly by touching and dragging it on the monitor. Set [Touch Operation] to [On], and set [Func. of Touch Operation] to [Touch Focus] beforehand.

Note

- [Focus Area] is locked to [Wide] in the following situations:
 - [Scene Selection]
 - During Smile Shutter mode
 - The shooting mode is set to  (Movie) or  ( Intelligent Auto), and [Auto Dual Rec] is set to [On].
- The focus area may not light up during continuous shooting or when the shutter button is pressed all the way down at once.
- When the shooting mode is set to  (Movie),  ( Intelligent Auto), or **HFR** (High Frame Rate), or during movie shooting, [Tracking] cannot be selected for [Focus Area].
- When [Subject Detection] for [Face/Eye AF Set.] is set to [Animal], [Tracking] cannot be selected as the [Focus Area].

- You cannot perform functions assigned to the control wheel or the custom button 2 while moving the focusing frame.

Related Topic

- [Touch Operation](#)

5-016-934-11(1) Copyright 2020 Sony Corporation

Focusing on eyes (Face/Eye AF Set.)

[Face/Eye AF Set.] is used to determine whether or not the camera focuses with priority on faces/eyes.

There are two methods for performing [Eye AF], with some differences between their specifications. Select the appropriate method according to your purpose.

Item	[Eye AF] via [Face/Eye AF Set.]	[Eye AF] via a custom key Details can be found here. →
Subject detection	The camera will detect faces/eyes with greater priority.	The camera will detect faces/eyes exclusively.
Advance preparation	Select [Face/Eye AF Set.] → [Face/Eye Priority in AF] → [On].	Assign [Eye AF] to the desired key using [Custom Key] or [Custom Key].
How to perform [Eye AF]	Press the shutter button halfway down.	Press the key to which you have assigned the [Eye AF] function*.
Specifications	<ul style="list-style-type: none"> When the camera detects a face or eye inside or around the designated focus area, it focuses on the face or eye with greater priority. If the camera does not detect any faces or eyes inside or around the designated focus area, it will focus on another detectable subject. 	<ul style="list-style-type: none"> The camera focuses exclusively on faces or eyes anywhere on the screen, regardless of the setting for [Focus Area]. The camera will not automatically focus on another subject if no face or eye is detected anywhere on the screen.
Focus mode	Follows the setting designated with [Focus Mode]	Follows the setting designated with [Focus Mode]
Focus area	Follows the setting designated with [Focus Area]	The focus area temporarily becomes the entire screen, regardless of the setting for [Focus Area].
How the following functions under [Face/Eye AF Set.] work <ul style="list-style-type: none"> Subject Detection Right/Left Eye Select Face/Eye Frame Display Animal Eye Display 	Follows the setting designated with each menu item	Follows the setting designated with each menu item

* Regardless of whether [Face/Eye Priority in AF] under [Face/Eye AF Set.] is set to [On] or [Off], you can use [Eye AF] via a custom key while you are pressing the custom key to which you have assigned [Eye AF].

1 MENU →  1 (Camera Settings1) → [Face/Eye AF Set.] → desired setting item.

Menu item details

Face/Eye Priority in AF :

Sets whether or not to detect faces or eyes inside the focusing area and focus on the eyes (Eye AF) when autofocus is activated. ([On]/[Off])

(Note: The camera operations are different when using the custom key to execute [Eye AF].)

Subject Detection :

Selects the target to be detected.

[Human]: Detects human faces/eyes.

[Animal]: Detects animal eyes. Animal faces are not detected.

Right/Left Eye Select :

Specifies the eye to be detected when [Subject Detection] is set to [Human]. If [Right Eye] or [Left Eye] is selected, only the selected eye is detected. When [Subject Detection] is set to [Animal], [Right/Left Eye Select] cannot be used.

[Auto]: The camera detects eyes automatically.

[Right Eye]: The right eye of the subject (the eye on the left side from the photographer's perspective) is detected.

[Left Eye]: The left eye of the subject (the eye on the right side from the photographer's perspective) is detected.

Face/Eye Frame Display :

Sets whether or not to display the face/eye detection frame when a human face or eyes are detected. ([On]/[Off])

Animal Eye Display :

Sets whether or not to display the eye detection frame when the eye of an animal is detected. ([On]/[Off])

Face detection frame

When the product detects a face, the gray face detection frame appears. When the product determines that autofocus is enabled, the face detection frame turns white.

In case you have registered the priority order for each face using [Face Registration], the product automatically selects the first prioritized face and the face detection frame over that face turns white. The face detection frames of other registered faces turn reddish-purple.



Eye detection frame

A white eye detection frame appears when an eye is detected and the camera determines that autofocusing is possible, depending on the settings.

The eye detection frame is displayed when [Subject Detection] is set to [Animal].



[Eye AF] by custom key

The Eye AF function can also be used by assigning [Eye AF] to a custom key. The camera can focus on eyes as long as you are pressing the key. This is useful when you want to temporarily apply the Eye AF function to the entire screen regardless of the setting for [Focus Area]. The camera does not focus automatically if no faces or eyes are detected. (Note: When you try to focus on eyes by pressing the shutter button halfway down, the camera only detects faces or eyes inside or around the focus area designated with [Focus Area]. If the camera detects no faces or eyes, it performs normal auto-focusing.)

1. MENU → (Camera Settings2) → [Custom Key] or [Custom Key] → desired key, then assign the [Eye AF] function to the key.
2. MENU → (Camera Settings1) → [Face/Eye AF Set.] → [Subject Detection] → desired setting.
3. Point the camera at the face of a human or animal, and press the key to which you have assigned the [Eye AF] function.
To shoot a still image, press the shutter button while pressing the key.

[Switch Right/Left Eye] by custom key

When [Subject Detection] is set to [Human] and [Right/Left Eye Select] is set to [Right Eye] or [Left Eye], you can switch the eye to be detected by pressing the custom key to which you have assigned the [Switch Right/Left Eye] function. When [Right/Left Eye Select] is set to [Auto], you can temporarily switch the eye to be detected by pressing the custom key to which you have assigned the [Switch Right/Left Eye] function.

The temporary left/right selection is cancelled when you perform the following operations, etc. The camera returns to automatic eye detection.

- Pressing the center of the control wheel
- Stopping pressing the shutter button halfway down (only during still image shooting)
- Stopping pressing the custom key to which [Eye AF] is assigned (only during still image shooting)
- Pressing the MENU button

Hint

- When [Right/Left Eye Select] is not set to [Auto], or you execute [Switch Right/Left Eye] using the custom key, the eye detection frame appears. Even when [Right/Left Eye Select] is set to [Auto], if [Face/Eye Frame Display] is set to [On], the eye detection frame will appear over detected eyes during movie shooting.
- If you want the face or eye detection frame to disappear within a certain period of time after the camera has focused on the face or eye, set [AF Area Auto Clear] to [On].

Note

- When [Subject Detection] is set to [Human], the eyes of animals are not detected. When [Subject Detection] is set to [Animal], human faces are not detected.
- When [Scene Selection] is set to [Portrait], [Face/Eye Priority in AF] is locked to [On], and [Subject Detection] is locked to [Human].
- When [Scene Selection] is set to [Pet], [Face/Eye Priority in AF] is locked to [On], and [Subject Detection] is locked to [Animal].
- When [Smile Shutter] is set to [On], [Face/Eye Priority in AF] is locked to [On], and [Subject Detection] is locked to [Human].
- When [Subject Detection] is set to [Animal], the following functions cannot be used.
 - Right/Left Eye Select
 - Tracking function
 - Face Priority in Multi Metering
 - Regist. Faces Priority
 - Soft Skin Effect
- The [Eye AF] function may not function very well in the following situations:

- When the person is wearing sunglasses.
 - When the front hair covers the person's eyes.
 - In low-light or back-lit conditions.
 - When the eyes are closed.
 - When the subject is in the shade.
 - When the subject is out of focus.
 - When the subject is moving too much.
- If the subject is moving too much, the detection frame may not be displayed correctly over their eyes.
 - Depending on the circumstances, the eyes cannot be focused.
 - When the camera cannot focus on human eyes, it will detect and focus on the face instead. The camera cannot focus on eyes when no human faces are detected.
 - The product may not detect faces at all or may accidentally detect other objects as faces in some conditions.
 - When recording movies with [Subject Detection] set to [Animal], you cannot use the eye detection function.
 - When shooting movies, eyes at the right and left edges of the screen cannot be detected.
 - The eye detection frame is not displayed when the Eye AF function is unavailable.
 - You cannot use the face/eye detection function with the following functions:
 - Zoom functions other than the optical zoom.
 - [Sweep Panorama]
 - [Posterization] under [Picture Effect]
 - Focus Magnifier
 - When [Scene Selection] is set to [Landscape], [Night Scene], or [Sunset]
 - Movie shooting with [Record Setting] set to [120p]/[100p]
 - When shooting with a high frame rate.
 - When [File Format] is set to [XAVC S 4K], [Record Setting] is set to [30p 100M]/[25p 100M] or [30p 60M]/[25p 60M], and [4K Output Select] is set to [Memory Card+HDMI]
 - When [File Format] is set to [XAVC S 4K] and [Proxy Recording] is set to [On]
 - Up to 8 faces of your subjects can be detected.
 - Even if [Face/Eye Frame Display] or [Animal Eye Display] is set to [Off], a green focusing frame will be displayed over faces or eyes that are in focus.
 - To detect animal eyes, arrange the composition so that both eyes and the nose of the animal are within the angle of view. Once you focus on the animal's face, the animal's eyes will be detected more easily.
 - Even when [Subject Detection] is set to [Animal], the eyes of some types of animals cannot be detected.

Related Topic

- [Focus Mode](#)
- [Focus Area](#)
- [AF Area Auto Clear](#)
- [Assigning frequently used functions to buttons \(Custom Key\)](#)

Digital Camera
ZV-1

Pre-AF (still image)

The product automatically adjusts focus before you press the shutter button halfway down. During focusing operations, the screen may shake.

1 MENU →  1 (Camera Settings1) → [ Pre-AF] → **desired setting.**

Menu item details

On:

Adjusts focus before you press the shutter button halfway down.

Off:

Does not adjust focus before you press the shutter button halfway down.

Digital Camera
ZV-1

Focus Frame Color

You can specify the color of the frame indicating the focusing area. If the frame is difficult to see because of the subject, make it more visible by changing its color.

1 MENU →  1 (Camera Settings1) → [Focus Frame Color] → desired color.

Menu item details

White:

Displays the frame indicating the focusing area in white.

Red:

Displays the frame indicating the focusing area in red.

Digital Camera
ZV-1

AF Area Auto Clear

Sets whether the focus area should be displayed all the time or should disappear automatically shortly after focus is achieved.

1 MENU →  1 (Camera Settings1) → [AF Area Auto Clear] → desired setting.

Menu item details

On:

The focus area disappears automatically shortly after focus is achieved.

Off:

The focus area is displayed all the time.

Digital Camera
ZV-1

Disp. cont. AF area

You can set whether or not to display the area that is in focus when [Focus Area] is set to [Wide] or [Zone], in [Continuous AF] mode.

1 MENU →  1 (Camera Settings1) → [Disp. cont. AF area] → desired setting.

Menu item details

On:

Displays the focus area that is in focus.

Off:

Does not display the focus area that is in focus.

Note

- When [Focus Area] is set to one of the following, the focusing frames in the area that is in focus turn green:
 - [Center]
 - [Flexible Spot]
 - [Expand Flexible Spot]

Digital Camera
ZV-1

Phase Detect. Area

Sets whether or not to display the Phase Detection AF area.

1 MENU →  1 (Camera Settings1) → [Phase Detect. Area] → desired setting.

Menu item details



On:

Displays the Phase Detection AF area.

Off:

Does not display the Phase Detection AF area.

Note

- When the F-value is larger than F8, Phase Detection AF cannot be used. Only Contrast AF is available.
- When [ File Format] is set to [XAVC S HD] and [ Record Setting] is set to [120p]/[100p], Phase Detection AF cannot be used. Only Contrast AF is available.
- When recording movies, the Phase Detection AF area will not be displayed.

Digital Camera
ZV-1

Circ. of Focus Point

Sets whether to allow the focusing frame to jump from one end to the other when you move the focusing frame with [Focus Area] set to [Zone], [Flexible Spot], [Expand Flexible Spot], [Tracking: Zone], [Tracking: Flexible Spot] or [Tracking: Expand Flexible Spot]. This function is useful when you want to move the focusing frame from one end to the other quickly.

1 MENU →  (Camera Settings1) → [Circ. of Focus Point] → desired setting.

When [Circulate] is selected:

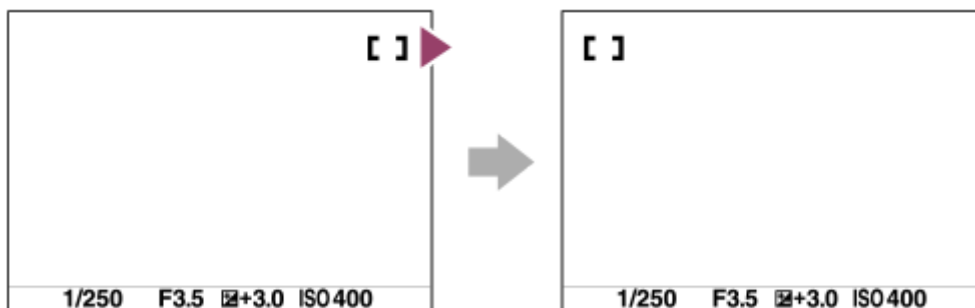

Menu item details

Does Not Circulate :

The cursor does not move when you try to move the focusing frame past the end.

Circulate :

The cursor jumps to the opposite end when you try to move the focusing frame past the end.

Related Topic

- [Focus Area](#)



Manual Focus (Set Focus)

If it is difficult to focus properly in the autofocus mode, you can adjust the focus manually.

1 MENU →  (Camera Settings1) → [Focus Mode] → [Manual Focus].

2 MENU →  (Camera Settings1) → [Set Focus].

The screen for manual focusing operations will appear.

- The screen for manual focusing operations can also be displayed by pressing the key to which [Focus Standard] has been assigned using [ Custom Key] or [ Custom Key].

3 Press the left/right side of the control wheel or turn the control wheel to adjust the focus.

- The focus distance will be displayed on the screen.
- To enable fine adjustments to the focus under various conditions, the focusing indicator can be moved beyond infinity. When you want to focus at infinity, do not move the indicator to the end of the bar. Instead, adjust the focus while checking the monitor, etc.
- To return to the shooting screen, press the center of the control wheel.

4 Press the shutter button all the way down to shoot.

Hint

- Using [ MF Assist] allows you to manually focus more easily because the image is automatically enlarged during manual focus adjustments. While the magnified image is displayed, you can use the top/bottom/left/right side of the control wheel to adjust which part of the image to magnify. Turn the control wheel to adjust the focus. You can also change the magnification scale by pressing the center of the control wheel.
- When you use [Peaking Setting], the outlines of in-focus ranges are enhanced using a specific color. This function allows you to check the focus easily.

Note

- Manually set focus distances are cancelled when [Focus Mode] is reselected.
- The displayed focus distance is just a reference.

Related Topic

- [MF Assist \(still image\)](#)
- [Peaking Setting](#)

Exposure Comp.

Normally, exposure is set automatically (auto exposure). Based on the exposure value set by auto exposure, you can make the entire image brighter or darker if you adjust [Exposure Comp.] to the plus side or minus side, respectively (exposure compensation).

- 1  (Exposure Comp.) on the control wheel → press the left/right side of the control wheel or turn the control wheel, and select the desired setting.

+ (over) side:

Images become brighter.

- (under) side:

Images become darker.

- You can also select MENU →  1 (Camera Settings1) → [Exposure Comp.].

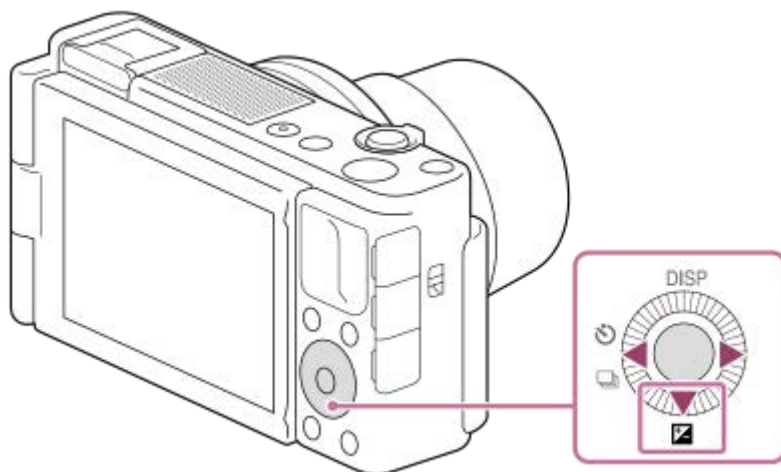

- You can adjust the exposure compensation value within the range of -3.0 EV to +3.0 EV.
- You can confirm the exposure compensation value that you set on the shooting screen.

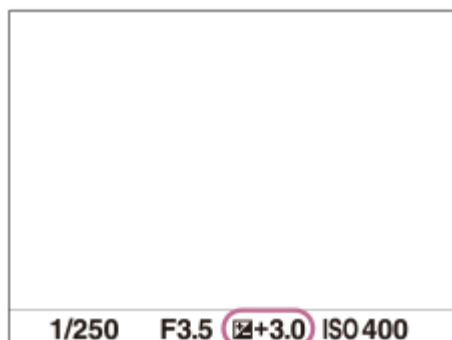

Note

- You cannot perform the exposure compensation in the following shooting modes:
 - [Intelligent Auto]
 - [Scene Selection]
 - [ Intelligent Auto]
- When using [Manual Exposure], you can perform the exposure compensation only when [ISO] is set to [ISO AUTO].

- You can adjust the exposure compensation value within the range of -2.0 EV to +2.0 EV for movies.
- If you shoot a subject in extremely bright or dark conditions, or when you use the flash, you may not be able to get a satisfactory effect.

Related Topic

- [Exp.comp.set](#)
- [Cont. Bracket](#)
- [Single Bracket](#)
- [Zebra Setting](#)

5-016-934-11(1) Copyright 2020 Sony Corporation

Digital Camera
ZV-1

ISO

Sensitivity to light is expressed by the ISO number (recommended exposure index). The larger the number, the higher the sensitivity.

1 MENU →  (Camera Settings1) → [ISO] → desired setting.

Menu item details

Multi Frame NR:

Combines continuous shots to create an image with less noise. Press the right side to display the setting screen, then select a desired value using the top/bottom sides of the control wheel.

Select the desired ISO number from ISO AUTO or ISO 200 – ISO 25600.

ISO AUTO:

Sets the ISO sensitivity automatically.



ISO 80 – ISO 12800:

Sets the ISO sensitivity manually. Selecting a larger number increases the ISO sensitivity.

Hint

- You can change the range of ISO sensitivity that is set automatically in [ISO AUTO] mode. Select [ISO AUTO] and press the right side of the control wheel, and set the desired values for [ISO AUTO Maximum] and [ISO AUTO Minimum]. The values are also applied when shooting in [ISO AUTO] mode under [Multi Frame NR].

Note

- When [ File Format] is set to [RAW] or [RAW & JPEG], [Multi Frame NR] cannot be selected.
- When [Multi Frame NR] is selected, the flash (sold separately), [D-Range Optimizer], or [Auto HDR] cannot be used.
- When [Picture Profile] is set to other than [Off], [Multi Frame NR] cannot be selected.
- When [Picture Effect] is set to other than [Off], [Multi Frame NR] cannot be selected.
- [ISO AUTO] is selected when using the following functions:
 - [Intelligent Auto]
 - [Scene Selection]
 - [Sweep Panorama]
 - [ Intelligent Auto]
- When the ISO sensitivity is set to a value lower than ISO 125, the range for recordable subject brightness (dynamic range) may decrease.
- The higher the ISO value, the more noise will appear on the images.
- The available ISO settings will differ depending on whether you are shooting still images, shooting movies, or using HFR.
- [Multi Frame NR] is not available when [Drive Mode] is set to [Cont. Shooting].
- When shooting movies, ISO values between 125 and 12800 are available. If the ISO value is set to a value smaller than 125, the setting is automatically switched to 125. When you finish recording the movie, the ISO value returns to the original setting.
- The available range for ISO sensitivity varies depending on the setting for [Gamma] under [Picture Profile].
- When you use [Multi Frame NR], it takes some time for the product to perform the overlay processing of images.
- When you select [ISO AUTO] with the shooting mode set to [P], [A], [S] or [M], the ISO sensitivity will be automatically adjusted within the set range.

Digital Camera
ZV-1

ND Filter

If you use an ND filter, the amount of light entering the camera is reduced. You can slow down the shutter speed and decrease the aperture value for a better exposure.

1 MENU →  1 (Camera Settings1) → [ND Filter] → desired setting.

Menu item details

 **Auto:**

Automatically turns on the ND filter based on the shooting mode and brightness.

 **On:**

Always uses [ND Filter].

 **Off:**

Disables the [ND Filter] function.

Hint

- When the ND filter is activated, the icon is displayed on the bottom of the screen.

Note

- [Auto] cannot be selected in the movie mode. When recording movies, the setting for [ND Filter] is locked to the value at the start of movie recording.

Metering Mode

Selects the metering mode that sets which part of the screen to measure for determining the exposure.

1 MENU →  (Camera Settings1) → [Metering Mode] → desired setting.

Menu item details

Multi:

Measures light on each area after dividing the total area into multiple areas and determines the proper exposure of the entire screen (Multi-pattern metering).

Center:

Measures the average brightness of the entire screen, while emphasizing the central area of the screen (Center-weighted metering).

Spot:

Measures only inside the metering circle. This mode is suitable for measuring light at the center of the screen. The size of the metering circle can be selected from [Spot: Standard] and [Spot: Large].

Entire Screen Avg.:

Measures the average brightness of the entire screen. The exposure will be stable even if the composition or the position of the subject changes.

Highlight:

Measures the brightness while emphasizing the highlighted area on the screen. This mode is suitable for shooting the subject while avoiding overexposure.

Hint

- When [Multi] is selected and [Face Priority in Multi Metering] is set to [On], the camera measures brightness based on detected faces.
- When [Metering Mode] is set to [Highlight] and the [D-Range Optimizer] or [Auto HDR] function is activated, the brightness and the contrast will be corrected automatically by dividing the image into small areas and analyzing the contrast of light and shadow. Make settings based on the shooting circumstances.

Note

- [Metering Mode] is locked to [Multi] in the following shooting modes:
 - [Intelligent Auto]
 - [Scene Selection]
 -  Intelligent Auto
 - Other zoom functions than the optical zoom
- In [Highlight] mode, the subject may be dark if a brighter part exists on the screen.

Related Topic

- [AE lock](#)
- [Face Priority in Multi Metering](#)
- [D-Range Optimizer \(DRO\)](#)
- [Auto HDR](#)

Digital Camera
ZV-1

Face Priority in Multi Metering

Sets whether the camera measures brightness based on detected faces when [Metering Mode] is set to [Multi].

1 MENU →  1 (Camera Settings1) → [Face Priority in Multi Metering] → desired setting.

Menu item details

On:

The camera measures brightness based on detected faces.

Off:

The camera measures brightness using the [Multi] setting, without detecting faces.

Note

- When the shooting mode is set to [Intelligent Auto] or [ Intelligent Auto], [Face Priority in Multi Metering] is locked to [On].
- When [Face/Eye Priority in AF] is set to [On] and [Subject Detection] is set to [Animal] under [Face/Eye AF Set.], [Face Priority in Multi Metering] does not work.

Related Topic

- [Metering Mode](#)

Digital Camera
ZV-1

Flash Mode

You can set the flash mode of the flash (sold separately).

1 MENU →  1 (Camera Settings1) → [Flash Mode] → desired setting.

Menu item details

Flash Off:

The flash does not operate.

Autoflash:

The flash works in dark environments or when shooting towards bright light.

Fill-flash:

The flash works every time you trigger the shutter.

Slow Sync.:

The flash works every time you trigger the shutter. Slow sync shooting allows you to shoot a clear image of both the subject and the background by slowing the shutter speed.

Rear Sync.:

The flash works right before the exposure is completed every time you trigger the shutter. Rear sync shooting allows you to shoot a natural image of the trail of a moving subject such as a moving car or a walking person.

Note

- The default setting depends on the shooting mode.
- Some [Flash Mode] settings are not available, depending on the shooting mode.

Related Topic

- [Using flash \(sold separately\)](#)

Flash Comp.

Adjusts the amount of flash light in a range of -3.0 EV to $+3.0$ EV. Flash compensation changes the amount of flash light only. Exposure compensation changes the amount of flash light along with the change of the shutter speed and aperture.

1 MENU →  1 (Camera Settings1) → [Flash Comp.] → desired setting.

- Selecting higher values (+ side) makes the flash level higher, and lower values (- side) makes the flash level lower.

Note

- [Flash Comp.] does not work when the shooting mode is set to the following modes:
 - [Intelligent Auto]
 - [Sweep Panorama]
 - [Scene Selection]
- The higher flash effect (+ side) may not be visible due to the limited amount of flash light available, if the subject is outside the maximum range of the flash. If the subject is very close, the lower flash effect (- side) may not be visible.

Related Topic

- [Using flash \(sold separately\)](#)

Digital Camera
ZV-1

Exp.comp.set

Sets whether to apply the exposure compensation value to control both flash light and ambient light, or just ambient light.

1 MENU →  (Camera Settings1) → [Exp.comp.set] → desired setting.

Menu item details

Ambient&flash:

Applies the exposure compensation value to control both flash light and ambient light.

Ambient only:

Applies the exposure compensation value to control ambient light only.

Related Topic

- [Flash Comp.](#)

White Balance

Corrects the tone effect of the ambient light condition to record a neutral white subject in white. Use this function when the color tones of the image did not come out as you expected, or when you want to change the color tones on purpose for photographic expression.

1 MENU → 1 (Camera Settings1) → [White Balance] → desired setting.

Menu item details

AWB **Auto** / **Daylight** / **Shade** / **Cloudy** / **Incandescent** / **-1 Fluor.: Warm White** / **0 Fluor.: Cool White** / **+1 Fluor.: Day White** / **+2 Fluor.: Daylight** / **Flash** / **Underwater Auto** :

When you select a light source that illuminates the subject, the product adjusts the color tones to suit to the selected light source (preset white balance). When you select [Auto], the product automatically detects the light source and adjusts the color tones.

C.Temp./Filter:

Adjusts the color tones depending on the light source. Achieves the effect of CC (Color Compensation) filters for photography.

Custom 1/Custom 2/Custom 3:

Memorizes the basic white color under the light conditions for the shooting environment.

Hint

- You can display the fine adjustment screen and perform fine adjustments of the color tones as required by pressing the right side of the control wheel.
- If the color tones do not come out as you expected in the selected settings, perform [WB bracket] shooting.
- (Ambience) or (White) is displayed only when [Priority Set in AWB] is set to [Ambience] or [White].

Note

- [White Balance] is fixed to [Auto] in the following shooting modes:
 - [Intelligent Auto]
 - [Scene Selection]
 - [Intelligent Auto]
- If you use a mercury lamp or a sodium lamp as a light source, the accurate white balance will not be obtained because of the characteristics of the light. It is recommended to shoot images using a flash (sold separately) or select [Custom 1] to [Custom 3].

Related Topic

- [Capturing a standard white color to set the white balance \(custom white balance\)](#)
- [Priority Set in AWB](#)
- [WB bracket](#)

Digital Camera
ZV-1

Priority Set in AWB

Selects which tone to prioritize when shooting under lighting conditions such as incandescent light when [White Balance] is set to [Auto].

1 MENU →  1 (Camera Settings1) → [Priority Set in AWB] → desired setting.

Menu item details

AWB
STD **Standard:**

Shoots with standard auto white balance. The camera automatically adjusts the color tones.

AWB
Ambi **Ambience:**

Prioritizes the color tone of the light source. This is suitable when you want to produce a warm atmosphere.

AWB
White **White:**

Prioritizes a reproduction of white color when the color temperature of the light source is low.

Related Topic

- [White Balance](#)

Digital Camera
ZV-1

D-Range Optimizer (DRO)

By dividing the image into small areas, the product analyzes the contrast of light and shadow between the subject and the background, and creates an image with the optimal brightness and gradation.

- 1 MENU →  (Camera Settings1) → [DRO/Auto HDR] → [D-Range Optimizer].
- 2 Select the desired setting using the left/right sides of the control wheel.

Menu item details

D-Range Optimizer: Auto:

Corrects the brightness automatically.

D-Range Optimizer: Lv1 — D-Range Optimizer: Lv5:

Optimizes the gradation of a recorded image for each divided area. Select the optimization level from Lv1 (weak) to Lv5 (strong).

Note

- In the following situations, [DRO/Auto HDR] is fixed to [Off]:
 - The shooting mode is set to [Sweep Panorama].
 - Multi Frame NR
 - When [Picture Effect] is set to other than [Off]
 - When [Picture Profile] is set to other than [Off]
- [DRO/Auto HDR] is fixed to [Off] when the following modes are selected in [Scene Selection].
 - [Sunset]
 - [Night Scene]
 - [Night Portrait]
 - [Hand-held Twilight]
 - [Anti Motion Blur]
 - [Fireworks]

The setting is fixed to [D-Range Optimizer: Auto] when [Scene Selection] modes other than the above modes are selected.
- When [ Record Setting] is set to [120p 100M], [100p 100M], [120p 60M], or [100p 60M], [DRO/Auto HDR] switches to [Off].
- When shooting with [D-Range Optimizer], the image may be noisy. Select the proper level by checking the recorded image, especially when you enhance the effect.

Digital Camera
ZV-1

Auto HDR

Shoots three images using different exposures and combines the images with correct exposure, the bright parts of an underexposed image, and the dark parts of an overexposed image to create images with a greater range of gradation (High Dynamic Range). One image with proper exposure and one overlaid image are recorded.

1 MENU →  1 (Camera Settings1) → [DRO/Auto HDR] → [Auto HDR].

2 Select the desired setting using the left/right sides of the control wheel.

Menu item details

 **Auto HDR: Exposure Diff. Auto:**
Corrects the brightness automatically.

 **Auto HDR: Exposure Diff. 1.0EV — Auto HDR: Exposure Diff. 6.0EV:**



Sets the exposure difference, based on the contrast of the subject. Select the optimization level from 1.0EV (weak) to 6.0EV (strong).

For example, if you set the exposure value to 2.0 EV, three images will be composed with the following exposure levels: -1.0 EV, correct exposure and +1.0 EV.

Hint

- The shutter is released three times for one shot. Be careful about the following:
 - Use this function when the subject is motionless or does not flash light.
 - Do not change the composition during shooting.

Note

- This function is not available when the [ File Format] is [RAW] or [RAW & JPEG].
- [Auto HDR] is not available in the following shooting modes:
 - [Intelligent Auto]
 - [Sweep Panorama]
 - [Scene Selection]
- [Auto HDR] is not available in the following situations:
 - When [Multi Frame NR] is selected.
 - When [Picture Effect] is set to other than [Off].
 - When [Picture Profile] is set to other than [Off].
- You cannot start the next shot until the capture process is completed after you shoot.
- You may not obtain the desired effect depending on the luminance difference of a subject and the shooting conditions.
- When the flash is used, this function has little effect.
- When the contrast of the scene is low or when product shake or subject blur occurs, you may not obtain good HDR images.   (Auto HDR error) will be displayed over the recorded image to inform you when the camera detects image blurring. Change the composition or re-shoot the image carefully to avoid image blur, as needed.

Creative Style

Allows you to set the desired image processing and finely adjust contrast, saturation and sharpness for each image style. You can adjust exposure (shutter speed and aperture) as you like with this function, unlike with [Scene Selection], where the product adjusts the exposure.

- 1 MENU → 1 (Camera Settings1) → [Creative Style].
- 2 Select the desired style using the top/bottom sides of the control wheel.
- 3 To adjust (Contrast), (Saturation) and (Sharpness), select the desired item using the right/left sides, and then select the value using the top/bottom sides.

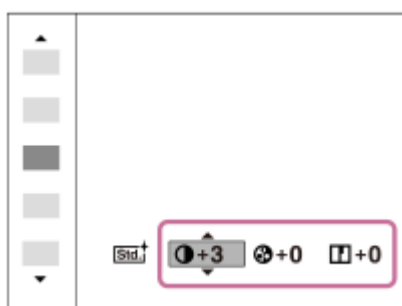

Menu item details

Standard:

For shooting various scenes with rich gradation and beautiful colors.

Vivid:

The saturation and contrast are heightened for shooting striking images of colorful scenes and subjects such as flowers, spring greenery, blue sky, or ocean views.

Portrait:

For capturing skin in a soft tone, ideally suited for shooting portraits.

Landscape:

The saturation, contrast, and sharpness are heightened for shooting vivid and crisp scenery. Distant landscapes also stand out more.

Sunset:

For shooting the beautiful red of the setting sun.

Black & White:

For shooting images in black and white monotone.

Sepia:

For shooting images in sepia monotone.

To set [Contrast], [Saturation] and [Sharpness]

[Contrast], [Saturation], and [Sharpness] can be adjusted for each image style preset such as [Standard] and [Landscape].

Select an item to be set by pressing the right/left sides of the control wheel, then set the value using the top/bottom sides of the control wheel.

Contrast:

The higher the value selected, the more the difference of light and shadow is accentuated, and the bigger the effect on the image.

 **Saturation:**

The higher the value selected, the more vivid the color. When a lower value is selected, the color of the image is restrained and subdued.

 **Sharpness:**

Adjusts the sharpness. The higher the value selected, the more the contours are accentuated, and the lower the value selected, the more the contours are softened.

Note

- [Creative Style] is fixed to [Standard] in the following situations:
 - [Intelligent Auto]
 - [Scene Selection]
 - [ Intelligent Auto]
 - [Picture Effect] is set to other than [Off].
 - [Picture Profile] is set to other than [Off].

- When this function is set to [Black & White] or [Sepia], [Saturation] cannot be adjusted.

Digital Camera
ZV-1

Picture Effect

Select the desired effect filter to achieve more impressive and artistic images.

1 MENU →  (Camera Settings1) → [Picture Effect] → desired setting.

Menu item details

 **Off:**

Disables the [Picture Effect] function.

 **Toy Camera:**

Creates a soft image with shaded corners and reduced sharpness.

 **Pop Color:**

Creates a vivid look by emphasizing color tones.

 **Posterization:**

Creates a high contrast, abstract look by heavily emphasizing primary colors, or in black and white.

 **Retro Photo:**

Creates the look of an aged photo with sepia color tones and faded contrast.

 **Soft High-key:**

Creates an image with the indicated atmosphere: bright, transparent, ethereal, tender, soft.

 **Partial Color:**

Creates an image which retains a specific color, but converts others to black and white.

 **High Contrast Mono.:**

Creates a high-contrast image in black and white.

 **Soft Focus:**

Creates an image filled with a soft lighting effect.

 **HDR Painting:**

Creates the look of a painting, enhancing the colors and details.

 **Rich-tone Mono.:**

Creates an image in black and white with rich gradation and reproduction of details.

 **Miniature:**

Creates an image which enhances the subject vividly, with the background defocused considerably. This effect may often be found in pictures of miniature models.

 **Watercolor:**

Creates an image with ink bleed and blurring effects as if painted using watercolors.

 **Illustration:**

Creates an illustration-like image by emphasizing the outlines.

Hint



- You can perform detailed settings for some items using the left/right sides of the control wheel.

Note

- When you use a zoom function other than the optical zoom, setting the zoom scale larger makes [Toy Camera] less effective.
- When [Partial Color] is selected, images may not retain the selected color, depending on the subject or shooting conditions.
- You cannot check the following effects on the shooting screen, because the product processes the image after the shot. Also, you cannot shoot another image until image processing is finished. You cannot use these effects with movies.
 - [Soft Focus]
 - [HDR Painting]

- [Rich-tone Mono.]
 - [Miniature]
 - [Watercolor]
 - [Illustration]
- In the case of [HDR Painting] and [Rich-tone Mono.], the shutter is released three times for one shot. Be careful about the following:
 - Use this function when the subject is motionless or does not flash light.
 - Do not change the composition during shooting.

When the contrast of the scene is low or when significant camera-shake or subject blur has occurred, you may not be able to obtain good HDR images. If the product detects such a situation,  (Picture Effect error) will appear on the recorded image to inform you of this situation. Change the composition or re-shoot the image carefully to avoid image blur, as needed.

- This function is not available in the following shooting modes:
 - [Intelligent Auto]
 - [Scene Selection]
 - [Sweep Panorama]
 - [ Intelligent Auto]
- When [ File Format] is set to [RAW] or [RAW & JPEG], this function is not available.

Picture Profile

Allows you to change the settings for the color, gradation, etc. For details on "Picture Profile," refer to <https://helpguide.sony.net/di/pp/v1/en/index.html>.

Customizing the picture profile

You can customize the picture quality by adjusting picture profile items such as [Gamma] and [Detail]. When setting these parameters, connect the camera to a TV or monitor, and adjust them while observing the picture on the screen.

- 1 MENU →  1 (Camera Settings1) → [Picture Profile] → the profile you want to change.**
- 2 Move to the item index screen by pressing the right side of the control wheel.**
- 3 Select the item to change using the top/bottom sides of the control wheel.**
- 4 Select the desired value using the top/bottom sides of the control wheel and press in the center.**

Using the preset of the picture profile

The default settings [PP1] through [PP10] for movies have been set in advance in the camera based on various shooting conditions.

MENU →  1 (Camera Settings1) → [Picture Profile] → desired setting.

PP1:

Example setting using [Movie] gamma.

PP2:

Example setting using [Still] gamma.

PP3:

Example setting of natural color tone using the [ITU709] gamma.

PP4:

Example setting of a color tone faithful to the ITU709 standard.

PP5:

Example setting using [Cine1] gamma.

PP6:

Example setting using [Cine2] gamma.

PP7:

Example setting using [S-Log2] gamma.

PP8:

Example setting using the [S-Log3] gamma and the [S-Gamut3.Cine] under [Color Mode].

PP9:

Example setting using the [S-Log3] gamma and the [S-Gamut3] under [Color Mode].

PP10:

Example setting for recording HDR movies using [HLG2] gamma.

HDR movie recording

The camera can record HDR movies when a gamma from [HLG], [HLG1] to [HLG3] is selected in the picture profile. Picture profile preset [PP10] provides an example setting for HDR recording. Movies recorded using [PP10] can be viewed with a wider range of brightness than usual when played back on a TV supporting Hybrid Log-Gamma (HLG).

This way, even scenes with a wide range of brightness can be recorded and displayed faithfully, without looking under or over-exposed. HLG is used in HDR TV program production, as defined in the international standard Recommendation ITU-R BT.2100.

Items of the picture profile

Black Level

Sets the black level. (-15 to +15)

Gamma

Selects a gamma curve.

Movie: Standard gamma curve for movies

Still: Standard gamma curve for still images

Cine1: Softens the contrast in dark parts and emphasizes gradation in bright parts to produce a relaxed color movie. (equivalent to HG4609G33)

Cine2: Similar to [Cine1] but optimized for editing with up to 100% video signal. (equivalent to HG4600G30)

ITU709: Gamma curve that corresponds to ITU709.

ITU709(800%): Gamma curve for confirming scenes on the assumption of shooting using [S-Log2] or [S-Log3].

S-Log2: Gamma curve for [S-Log2]. This setting is based on the assumption that the picture will be processed after shooting.

S-Log3: Gamma curve for [S-Log3] with more similar features to film. This setting is based on the assumption that the picture will be processed after shooting.

HLG: Gamma curve for HDR recording. Equivalent to the HDR standard Hybrid Log-Gamma, ITU-R BT.2100.

HLG1: Gamma curve for HDR recording. Emphasizes noise reduction. However, shooting is restricted to a narrower dynamic range than with [HLG2] or [HLG3].

HLG2: Gamma curve for HDR recording. Provides a balance of dynamic range and noise reduction.

HLG3: Gamma curve for HDR recording. Wider dynamic range than [HLG2]. However, noise may increase.

- [HLG1], [HLG2], and [HLG3] all apply a gamma curve with the same characteristics, but each offers a different balance between dynamic range and noise reduction. Each has a different maximum video output level, as follows: [HLG1]: approx. 87%, [HLG2]: approx. 95%, [HLG3]: approx. 100%.

Black Gamma

Corrects gamma in low intensity areas.

[Black Gamma] is fixed at "0" and cannot be adjusted when [Gamma] is set to [HLG], [HLG1], [HLG2], or [HLG3].

Range: Selects the correcting range. (Wide / Middle / Narrow)

Level: Sets the correcting level. (-7 (maximum black compression) to +7 (maximum black stretch))

Knee

Sets knee point and slope for video signal compression to prevent over-exposure by limiting signals in high intensity areas of the subject to the dynamic range of your camera.

[Knee] is disabled if [Mode] is set to [Auto] when [Gamma] is set to [Still], [Cine1], [Cine2], [ITU709(800%)], [S-Log2], [S-Log3], [HLG], [HLG1], [HLG2], or [HLG3]. To enable [Knee], set [Mode] to [Manual].

Mode: Selects auto/manual settings.

- Auto: The knee point and slope are set automatically.
- Manual: The knee point and slope are set manually.

Auto Set: Settings when [Auto] is selected for [Mode].

- Max Point: Sets the maximum point of the knee point. (90% to 100%)
- Sensitivity: Sets the sensitivity. (High / Mid / Low)

Manual Set: Settings when [Manual] is selected for [Mode].

- Point: Sets the knee point. (75% to 105%)
- Slope: Sets the knee slope. (-5 (gentle) to +5 (steep))

Color Mode

Sets type and level of colors.

In [Color Mode], only [BT.2020] and [709] are available when [Gamma] is set to [HLG], [HLG1], [HLG2], or [HLG3].

Movie: Suitable colors when [Gamma] is set to [Movie].

Still: Suitable colors when [Gamma] is set to [Still].

Cinema: Suitable colors when [Gamma] is set to [Cine1] or [Cine2].

Pro: Similar color tones to the standard image quality of Sony professional cameras (when combined with ITU709 gamma)

ITU709 Matrix: Colors corresponding to ITU709 standard (when combined with ITU709 gamma)

Black & White: Sets the saturation to zero for shooting in black and white.

S-Gamut: Setting based on the assumption that the pictures will be processed after shooting. Used when [Gamma] is set to [S-Log2].

S-Gamut3.Cine: Setting based on the assumption that the pictures will be processed after shooting. Used when [Gamma] is set to [S-Log3]. This setting allows you to shoot in a color space that can easily be converted for digital cinema.

S-Gamut3: Setting based on the assumption that the pictures will be processed after shooting. Used when [Gamma] is set to [S-Log3]. This setting allows you to shoot in a wide color space.

BT.2020: Standard color tone when [Gamma] is set to [HLG], [HLG1], [HLG2], or [HLG3].

709: Color tone when [Gamma] is set to [HLG], [HLG1], [HLG2], or [HLG3] and movies are recorded with HDTV color (BT.709).

Saturation

Sets the color saturation. (-32 to +32)

Color Phase

Sets the color phase. (-7 to +7)

Color Depth

Sets the color depth for each color phase. This function is more effective for chromatic colors and less effective for achromatic colors. The color looks deeper as you increase the setting value towards the positive side, and lighter as you decrease the value towards the negative side. This function is effective even if you set [Color Mode] to [Black & White].

[R] -7 (light red) to +7 (deep red)

[G] -7 (light green) to +7 (deep green)

[B] -7 (light blue) to +7 (deep blue)

[C] -7 (light cyan) to +7 (deep cyan)

[M] -7 (light magenta) to +7 (deep magenta)

[Y] -7 (light yellow) to +7 (deep yellow)

Detail

Sets items for [Detail].

Level: Sets the [Detail] level. (-7 to +7)

Adjust: The following parameters can be selected manually.

- Mode: Selects auto/manual setting. (Auto (automatic optimization) / Manual (The details are set manually.))
- V/H Balance: Sets the vertical (V) and horizontal (H) balance of DETAIL. (-2 (off to the vertical (V) side) to +2 (off to the horizontal (H) side))
- B/W Balance: Selects the balance of the lower DETAIL (B) and the upper DETAIL (W). (Type1 (off to the lower DETAIL (B) side) to Type5 (off to the upper DETAIL (W) side))
- Limit: Sets the limit level of [Detail]. (0 (Low limit level: likely to be limited) to 7 (High limit level: unlikely to be limited))
- Crisping: Sets the crisping level. (0 (shallow crisping level) to 7 (deep crisping level))
- Hi-Light Detail: Sets the [Detail] level in the high intensity areas. (0 to 4)

To copy the settings to another picture profile number

You can copy the settings of the picture profile to another picture profile number.

MENU →  1 (Camera Settings1) → [Picture Profile] → [Copy].

To reset the picture profile to the default setting

You can reset the picture profile to the default setting. You cannot reset all picture profile settings at once.

MENU →  1 (Camera Settings1) → [Picture Profile] → [Reset].

Note

- Since the parameters are shared for movie and still images, adjust the value when you change the shooting mode.
- If you develop RAW images with shooting settings, the following settings are not reflected:
 - Black Level
 - Black Gamma
 - Knee
 - Color Depth
- When the [ Record Setting] is [120p 100M]/[100p 100M] or [120p 60M]/[100p 60M], [Black Gamma] is fixed at “0” and cannot be adjusted.
- If you change [Gamma], the available ISO value range changes.
- When using S-Log2 or S-Log3 gamma, the noise becomes more noticeable compared to when using other gammas. If the noise still is significant even after processing pictures, it may be improved by shooting with a brighter setting. However, the dynamic range becomes narrower accordingly when you shoot with a brighter setting. We recommend checking the picture in advance by test shooting when using S-Log2 or S-Log3.
- Setting [ITU709(800%)], [S-Log2] or [S-Log3] may cause an error in the white balance custom setup. In this case, perform custom setup with a gamma other than [ITU709(800%)], [S-Log2], or [S-Log3] first, and then reselect [ITU709(800%)], [S-Log2], or [S-Log3] gamma.
- Setting [ITU709(800%)], [S-Log2] or [S-Log3] disables the [Black Level] setting.
- If you set [Slope] to +5 in [Manual Set] under [Knee], [Knee] will be disabled.
- S-Gamut, S-Gamut3.Cine, and S-Gamut3 are color spaces exclusive to Sony. However, this camera's S-Gamut setting does not support the whole S-Gamut color space; it is a setting to achieve a color reproduction equivalent to S-Gamut.

Related Topic

- [Gamma Disp. Assist](#)

Digital Camera
ZV-1

Soft Skin Effect

Sets the effect used for shooting the skin smoothly in the Face Detection function.

1 MENU →  1 (Camera Settings1) → [Soft Skin Effect] → desired setting.

Menu item details













 Off:

Does not use the [Soft Skin Effect] function.

 On:

Uses the [Soft Skin Effect]. You can set the effect level by pressing the right/left side of the control wheel.





Note

- [Soft Skin Effect] is not available when [ File Format] is [RAW].
- [Soft Skin Effect] is not available for RAW images when the [ File Format] is [RAW & JPEG].
- [Soft Skin Effect] is not applied to still images shot using the Dual Rec function.
- [Soft Skin Effect] is not available in the following situations.
 - When the shooting mode is set to [Sweep Panorama]
 - During shooting standby or recording with the shooting mode set to [High Frame Rate]
 - When the shooting mode is set to [Landscape], [Sunset], [Night Scene], [Pet], [Gourmet], or [Fireworks] under [Scene Selection]
 - When [Picture Effect] is set to [Posterization]
 - While using the digital zoom function
- When the shooting mode is [Movie], [Soft Skin Effect] is not available in the following situations.
 - [ File Format] is set to [XAVC S 4K], and [ Proxy Recording] is set to [On].
 - [ File Format] is set to [XAVC S 4K], [ Record Setting] is set to [30p 100M] or [30p 60M], and [ 4K Output Select] is set to [Memory Card+HDMI].
 - [ File Format] is set to [XAVC S 4K], and [PC Remote] is set to [On].
 - [ File Format] is set to [XAVC S 4K], and [Ctrl w/ Smartphone] is in use.
 - [ File Format] is set to [XAVC S HD], and [ Record Setting] is set to [120p]/[100p].
- When the shooting mode is [Movie] or [ Intelligent Auto] and [ File Format] is set to [XAVC S 4K], the effect is not applied to the image on the monitor during shooting, but it is applied to the recorded image.

Focus Magnifier

You can check the focus by enlarging the image before shooting.

Unlike with [ MF Assist], you can magnify the image without needing to perform manual focusing operations.

- 1 MENU →  (Camera Settings1) → [Focus Magnifier].**
- 2 Press the center of the control wheel to enlarge the image and select the area you want to enlarge using top/bottom/left/right side of the control wheel.**
 - When you press the center of the control wheel, the magnification scale changes.
 - You can set the initial magnification by selecting MENU →  (Camera Settings1) → [ Initial Focus Mag.].
- 3 Confirm the focus.**
 - Press the  (Delete) button to bring the magnified position into the center of an image.
 - When the focus mode is [Manual Focus], you can adjust the focus while an image is magnified. The [Focus Magnifier] function will be canceled when the shutter button is pressed halfway.
 - You can set how long the image is to be shown magnified by selecting MENU →  (Camera Settings1) → [Focus Magnif. Time].
- 4 Press the shutter button fully down to shoot the image.**

To use the focus magnifier function by touch operation

You can magnify the image and adjust the focus by touching the monitor. Set [Touch Operation] to [On] beforehand. When the focus mode is [Manual Focus], you can perform [Focus Magnifier] by double-tapping the area to focus on.

Hint

- While using the focus magnifier function, you can move the magnified area by dragging it on the touch panel.
- To exit the focus magnifier function, double-tap the monitor again. You can also exit the focus magnifier function by pressing the shutter button halfway down.

Related Topic

- [MF Assist \(still image\)](#)
- [Focus Magnif. Time](#)
- [Initial Focus Mag. \(still image\)](#)
- [Touch Operation](#)

Digital Camera
ZV-1

Focus Magnif. Time

Set the duration for which an image is to be magnified using the [ MF Assist] or [Focus Magnifier] function.

1 MENU →  1 (Camera Settings1) → [Focus Magnif. Time] → desired setting.

Menu item details

2 Sec:

Magnifies the images for 2 seconds.

5 Sec:

Magnifies the images for 5 seconds.

No Limit:

Magnifies the images until you press the shutter button.



Related Topic

- [Focus Magnifier](#)
- [MF Assist \(still image\)](#)

Digital Camera
ZV-1

Initial Focus Mag. (still image)

Sets the initial magnification scale when using [Focus Magnifier]. Select a setting that will help you frame your shot.

1 MENU →  1 (Camera Settings1) → [ Initial Focus Mag.] → desired setting.

Menu item details

x1.0:

Displays the image with the same magnification as the shooting screen.

x5.3:

Displays a 5.3-times enlarged image.

Related Topic

- [Focus Magnifier](#)

Digital Camera
ZV-1

MF Assist (still image)

Enlarges the image on the screen automatically to make manual focusing easier. This works in Manual Focus or Direct Manual Focus shooting.

1 MENU →  1 (Camera Settings1) → [ MF Assist] → [On].

2 MENU →  1 (Camera Settings1) → [Set Focus].

- The image is enlarged. You can magnify images further by pressing the center of the control wheel.

Hint

- You can set how long the image is to be shown magnified by selecting MENU →  1 (Camera Settings1) → [Focus Magnif. Time].

Note

- You cannot use [ MF Assist] when shooting movies. Use the [Focus Magnifier] function instead.

Related Topic

- [Manual Focus \(Set Focus\)](#)
- [Direct manual focus \(DMF\)](#)
- [Focus Magnif. Time](#)

Peaking Setting

Sets the peaking function, which enhances the outline of in-focus areas during shooting with Manual Focus or Direct Manual Focus.

1 MENU →  1 (Camera Settings1) → [Peaking Setting] → desired setting.

Menu item details

Peaking Display:

Sets whether to display peaking.

Peaking Level:

Sets the level of enhancement of in-focus areas.

Peaking Color:

Sets the color used to enhance in-focus areas.

Note

- Since the product recognizes sharp areas as in focus, the effect of peaking differs, depending on the subject.
- The outline of in-focus ranges is not enhanced on devices connected via HDMI.

Related Topic

- [Manual Focus \(Set Focus\)](#)
- [Direct manual focus \(DMF\)](#)

Digital Camera
ZV-1

Product Showcase Set

The camera settings are optimally configured for situations such as movie shooting for product reviews. The camera tends to focus on objects that are closer to it.

1 MENU →  1 (Camera Settings1) → [Product Showcase Set] → desired setting.

Menu item details



On:

Shoots with optimal settings for product reviews. [Face/Eye Priority in AF] under [Face/Eye AF Set.] and [ SteadyShot] are both locked to [Off].

Off:

Shoots in the ordinary shooting mode.

Hint

- When you assign [Product Showcase Set] to a desired key using MENU →  2 (Camera Settings2) → [ Custom Key] or [ Custom Key], each time you press the key, [Product Showcase Set] switches between [On] and [Off]. In the default settings, [Product Showcase Set] is assigned to the C2 button.

Note

- [Product Showcase Set] is not available in the following shooting modes:
 - [Sweep Panorama]
 - [Scene Selection]
- Settings for [Product Showcase Set] cannot be changed during movie recording.
- Since [ SteadyShot] becomes set to [Off], we recommend that you use a tripod.

Face Registration (New Registration)

If you register faces in advance, the product can focus on the registered face as a priority.

- 1 MENU →  (Camera Settings1) → [Face Registration] → [New Registration].
- 2 Align the guide frame with the face to be registered, and press the shutter button.
- 3 When a confirmation message appears, select [Enter].

Note

- Up to eight faces can be registered.
- Shoot the face from the front in a brightly lit place. The face may not be registered correctly if it is obscured by a hat, a mask, sunglasses, etc.

Related Topic

- [Regist. Faces Priority](#)
- [Smile Shutter](#)

Digital Camera
ZV-1

Face Registration (Order Exchanging)

When multiple faces are registered to be given priority, the face registered first will be given priority. You can change the priority order.

- 1 MENU →  1 (Camera Settings1) → [Face Registration] → [Order Exchanging].
 - 2 Select a face to change the order of priority.
 - 3 Select the destination.
-

Related Topic

- [Regist. Faces Priority](#)
- [Smile Shutter](#)

Digital Camera
ZV-1

Face Registration (Delete)

Deletes a registered face.

1 MENU →  (Camera Settings1) → [Face Registration] → [Delete].

If you select [Delete All], you can delete all registered faces.

Note

- Even if you execute [Delete], the data for registered face will remain in the product. To delete the data for registered faces from the product, select [Delete All].

Digital Camera
ZV-1

Regist. Faces Priority

Sets whether to focus with higher priority on faces registered using [Face Registration].

1 MENU →  1 (Camera Settings1) → [Regist. Faces Priority] → desired setting.

Menu item details

On:

Focuses with higher priority on faces registered using [Face Registration].

Off:

Focuses without giving higher priority to registered faces.

Hint

- To use the [Regist. Faces Priority] function, set as follows.
 - [Face/Eye Priority in AF] under [Face/Eye AF Set.]: [On]
 - [Subject Detection] under [Face/Eye AF Set.]: [Human]

Related Topic

- [Focusing on eyes \(Face/Eye AF Set.\)](#)
- [Face Registration \(New Registration\)](#)
- [Face Registration \(Order Exchanging\)](#)

Digital Camera
ZV-1

Smile Shutter

The camera automatically shoots an image when it detects a smiling face.

1 MENU →  (Camera Settings1) → [Smile Shutter] → desired setting.

Menu item details

Off:

Does not use the [Smile Shutter] function.

On:

The camera automatically shoots an image when it detects a smiling face. You can select [On: Slight Smile], [On: Normal Smile], or [On: Big Smile] for the sensitivity of detection.

Tips for capturing smiles more effectively

- Do not cover the eyes with front hair and keep the eyes narrowed.
- Do not obscure the face by a hat, masks, sunglasses, etc.
- Try to orient the face in front of the product and be as level as possible.
- Give a clear smile with an open mouth. The smile is easier to be detected when the teeth are shown.
- If you press the shutter button during Smile Shutter, the product shoots the image. After shooting, the product returns to Smile Shutter mode.

Note

- You cannot use the [Smile Shutter] function with the following functions:
 - [Sweep Panorama]
 - [Picture Effect]
 - When using the [Focus Magnifier] function.
 - [Scene Selection] is set to [Landscape], [Night Scene], [Sunset], [Hand-held Twilight], [Anti Motion Blur], [Pet], [Gourmet] or [Fireworks].
 - When recording movies.
 - During High Frame Rate shooting
- Up to 8 faces of your subjects can be detected.
- The product may not detect faces at all or may accidentally detect other objects as faces in some conditions.
- If the product cannot detect a smile, adjust the Smile Detection Sensitivity.
- If [Func. of Touch Operation] is set to [Touch Tracking] and you touch a face on the monitor to track while [Smile Shutter] is active, smile detection will only apply to that face.

Digital Camera
ZV-1

Auto Object Framing (still image)

When this product detects and shoots faces, macro shooting subjects or subjects that are tracked by [Tracking], the product automatically trims the image into an appropriate composition, and then saves it. Both the original and the trimmed images are saved. The trimmed image is recorded in the same size as the original image size.



1 MENU → 1 (Camera Settings1) → [Auto Object Framing] → desired setting.

Menu item details

Off:

Does not trim images.

Auto:

Automatically trims images into an appropriate composition.

Note

- The trimmed image may not be the best possible composition, depending on the shooting conditions.
- [Auto Object Framing] cannot be set when [File Format] is set to [RAW] or [RAW & JPEG].
- [Auto Object Framing] is not available in the following situations.
 - When shooting movies
 - The shooting mode is set to [Sweep Panorama]
 - The shooting mode is set to [Hand-held Twilight], [Sports Action], [Anti Motion Blur], or [Fireworks] in [Scene Selection]
 - [Drive Mode] is set to [Cont. Shooting], [Self-timer(Cont)], [Cont. Bracket], [Single Bracket], [WB bracket], or [DRO Bracket].
 - The ISO sensitivity is set to [Multi Frame NR].
 - [DRO/Auto HDR] is set to [Auto HDR].
 - Other zoom functions than the optical zoom
 - When shooting in Manual Focus mode
 - [Picture Effect] is set to [Soft Focus], [HDR Painting], [Rich-tone Mono.], [Miniature], [Watercolor], or [Illustration].

Self-portrait/ -timer

You can change the angle of the monitor and shoot images while watching the monitor.

- 1 MENU →  1 (Camera Settings1) → [Self-portrait/ -timer] → [On].
- 2 Open the monitor transversely, face it forward, and then point the lens at yourself.

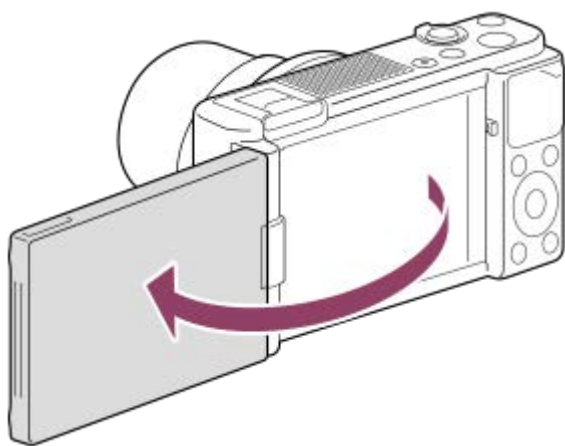

- 3 Press the shutter button. Alternatively, touch the subject on the monitor.



A picture is taken after 3 seconds using the self-timer function.

Hint

- If you want to use a drive mode other than the 3-second self-timer mode, first set [Self-portrait/ -timer] to [Off], and then face the monitor forward.

Movie: Exposure Mode

You can set the exposure mode for movie shooting.

- 1 MODE (Mode) button → [Movie] → press the center of the control wheel.**
 - You can also set the shooting mode by selecting MENU →  1 (Camera Settings1) → [Shoot Mode].
- 2 MENU →  2 (Camera Settings2) → [ Exposure Mode] → desired setting.**
- 3 Press the MOVIE (movie) button to start recording.**
 - Press the MOVIE button again to stop recording.

Menu item details

Program Auto:

Allows you to shoot with the exposure adjusted automatically (both the shutter speed and the aperture value).

Aperture Priority:

Allows you to shoot after adjusting the aperture value manually.

Shutter Priority:



Allows you to shoot after adjusting the shutter speed manually.

Manual Exposure:

Allows you to shoot after adjusting the exposure (both the shutter speed and the aperture value) manually.

HFR (High Frame Rate): Exposure Mode

You can select the exposure mode for HFR shooting based on the subject and effect you want.

- 1 MODE (Mode) button → [High Frame Rate] → press the center of the control wheel.**
 - You can also set the shooting mode by selecting MENU →  1 (Camera Settings1) → [Shoot Mode].
- 2 MENU →  2 (Camera Settings2) → [HFR Exposure Mode] → desired setting.**

Menu item details

HFR Program Auto:

Allows you to shoot with the exposure adjusted automatically (both the shutter speed and the aperture value).

HFR Aperture Priority:

Allows you to shoot after adjusting the aperture value manually.

HFR Shutter Priority:

Allows you to shoot after adjusting the shutter speed manually.

HFR Manual Exposure:



Allows you to shoot after adjusting the exposure (both the shutter speed and the aperture value) manually.

Related Topic

- [Shooting super-slow-motion movies \(HFR Settings\)](#)

File Format (movie)

Selects the movie file format.

1 MENU →  2 (Camera Settings2) → [ File Format] → desired setting.

Menu item details

Parameter	Description	What you can do using PlayMemories Home
XAVC S 4K	Records movies in 4K resolution (3840×2160).	You can save movies on a computer.
XAVC S HD	Records movies in crisper quality than AVCHD with larger amounts of data.	You can save movies on a computer.
AVCHD	The AVCHD format has a high degree of compatibility with storage devices other than computers.	You can save movies on a computer or create an AVCHD media.



Note

- When recording XAVC S 4K or XAVC S HD movies in 120p/100p, the amount of time available for continuous recording is approximately 5 minutes. The remaining time for movie recording is displayed on the monitor. However, when [Auto Power OFF Temp.] is set to [High], you can record movies continuously for over 5 minutes. If you want to record another session of 4K or HD 120p/100p movie shooting, turn off the camera and wait for some time before you start the next session of shooting. Even if the recording time was less than 5 minutes, recording may stop to protect the camera, depending on the temperature of the shooting environment.
- When [ File Format] is set to [AVCHD], the file size of movies is limited to approx. 2 GB. If the movie file size reaches approx. 2 GB during recording, a new movie file will be created automatically.

Digital Camera
ZV-1

Record Setting (movie)

Selects the frame rate and bit-rate for movie recording.

1 MENU →  2 (Camera Settings2) → [ Record Setting] → desired setting.

- The higher the bit-rate, the higher the image quality.

Menu item details

When [ File Format] is set to [XAVC S 4K]

 Record Setting	Bit-rate	Description
30p 100M/ 25p 100M	Approx. 100 Mbps	Records movies in 3840×2160 (30p/25p).
30p 60M/ 25p 60M	Approx. 60 Mbps	Records movies in 3840×2160 (30p/25p).
24p 100M *	Approx. 100 Mbps	Records movies in 3840×2160 (24p).
24p 60M *	Approx. 60 Mbps	Records movies in 3840×2160 (24p).

* Only when [NTSC/PAL Selector] is set to NTSC

When [ File Format] is set to [XAVC S HD]

 Record Setting	Bit-rate	Description
60p 50M/50p 50M	Approx. 50 Mbps	Records movies in 1920×1080 (60p/50p).
60p 25M/50p 25M	Approx. 25 Mbps	Records movies in 1920×1080 (60p/50p).
30p 50M/25p 50M	Approx. 50 Mbps	Records movies in 1920×1080 (30p/25p).
30p 16M/25p 16M	Approx. 16 Mbps	Records movies in 1920×1080 (30p/25p).
24p 50M *	Approx. 50 Mbps	Records movies in 1920×1080 (24p).
120p 100M/100p 100M	Approx. 100 Mbps	Records high-speed movies in 1920×1080 (120p/100p). You can record movies in 120 fps or 100 fps. <ul style="list-style-type: none"> • You can create smoother slow-motion movies by using compatible editing devices.



 Record Setting	Bit-rate	Description
120p 60M/100p 60M	Approx. 60 Mbps	Records high-speed movies in 1920×1080 (120p/100p). You can record movies in 120 fps or 100 fps. <ul style="list-style-type: none"> You can create smoother slow-motion movies by using compatible editing devices.

* Only when [NTSC/PAL Selector] is set to NTSC

When [File Format] is set to [AVCHD]

 Record Setting	Bit-rate	Description
60i 24M(FX)/50i 24M(FX)	24 Mbps at maximum	Records movies in 1920×1080 (60i/50i).
60i 17M(FH)/50i 17M(FH)	Approx. 17 Mbps on average	Records movies in 1920×1080 (60i/50i).

Note



- Creating an AVCHD recording disc from movies that were recorded with [60i 24M(FX)]/[50i 24M(FX)] as the [ Record Setting] takes a long time because the image quality of movies is converted. If you want to store movies without converting them, use a Blu-ray Disc.
- [120p]/[100p] cannot be selected for the following settings.
 - [Intelligent Auto]
 - [Scene Selection]
 - [ Intelligent Auto]

Shooting super-slow-motion movies (HFR Settings)

By shooting with a higher frame rate than the recording format, you can record a smooth super-slow-motion movie.

1 MODE (Mode) button → [High Frame Rate] → press the center of the control wheel.

The shooting mode becomes set to [High Frame Rate], and the shooting setting screen appears.

- You can also set the shooting mode by selecting MENU →  1 (Camera Settings1) → [Shoot Mode].
- You can select the desired exposure mode by selecting MENU →  2 (Camera Settings2) → [**HFR** Exposure Mode].

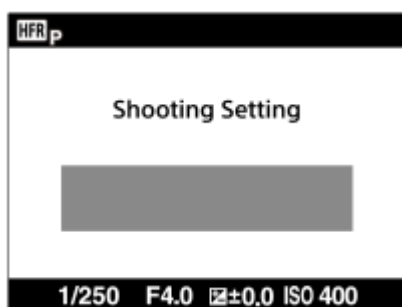

2 MENU → 2 (Camera Settings2) → [**HFR** HFR Settings] and select the desired settings for [**HFR** Record Setting], [**HFR** Frame Rate], [**HFR** Priority Setting], and [**HFR** REC Timing].

3 Point the camera at the subject and adjust settings such as the focus.

- You can also change other settings, such as focus mode, ISO sensitivity, etc.
- The focus becomes locked once the camera enters the shooting standby, even when using the auto focus. If you cannot focus on the intended subject using the auto focus, use the manual focus.

4 Press the center of the control wheel.

The shooting setting screen will close and the camera will switch to the shooting standby.

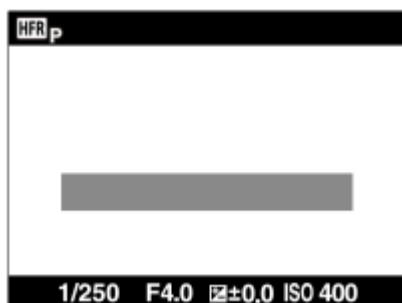

- You cannot adjust the exposure, adjust the focus, operate the zoom, etc. during the shooting standby. If you want to change the shooting settings, press the center of the control wheel again to return to the shooting setting screen.

5 Press the MOVIE (Movie) button.

When [**HFR** REC Timing] is set to [Start Trigger]:

Movie capturing (shooting) starts. When the MOVIE button is pressed again, or when the recordable duration of

time has elapsed, movie capturing ends and the camera starts to record the captured movie to the memory card.

When [HFR REC Timing] is set to [End Trigger] or [End Trigger Half]:

Movie capturing ends and the camera starts to record the captured movie to the memory card.

Menu item details

HFR Record Setting :

Selects the frame rate of the movie from [60p 50M]/[50p 50M], [30p 50M]/[25p 50M], and [24p 50M*].

* Only when [NTSC/PAL Selector] is set to NTSC.

HFR Frame Rate :

Selects the shooting frame rate from [240fps]/[250fps], [480fps]/[500fps], and [960fps]/[1000fps].

HFR Priority Setting :

Select from [Quality Priority] which prioritizes the image quality and [Shoot Time Priority] which prioritizes the duration of time of the movie.

HFR REC Timing :

Selects whether to record for a set amount of time after you press the MOVIE button ([Start Trigger]), or for a set amount of time until you press the MOVIE button ([End Trigger]/[End Trigger Half]).

Frame rate

In super-slow-motion movie shooting, the camera shoots at a faster shutter speed than the number of shooting frames per second. For example, when [HFR Frame Rate] is set to [960fps], the shutter speed per frame will be faster than approx. 1/1000 second in order to shoot 960 frames per second. To maintain this shutter speed, sufficient ambient light is necessary during shooting. If the ambient light is insufficient, the ISO sensitivity will become higher, resulting in more noise.

Shortest shooting distance

The image becomes out of focus when the subject is too close, such as during macro shooting. Shoot from the shortest shooting distance (W side: approximately 5 cm (0.16 ft), T side: approximately 30 cm (0.98 ft) (from the lens)) or further.

Timing of recording

Depending on the [HFR REC Timing] setting, the relationship between when you press the MOVIE button and the recorded section of the movie is as shown below.

[Start Trigger]

Movie capturing (shooting) starts when the MOVIE button is pressed. When the MOVIE button is pressed again, or when the recordable duration of time has elapsed, movie capturing ends and the camera starts to record the captured movie to the memory card.

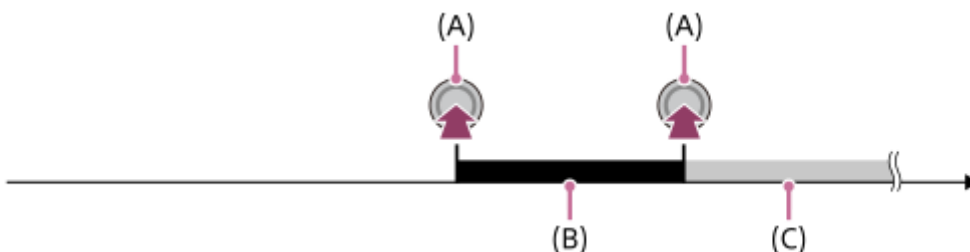

(A): The point when the MOVIE button is pressed

(B): Recorded section

(C): Recording to memory card in progress (You cannot start the next session of shooting.)

[End Trigger]/[End Trigger Half]

Buffering (temporarily capturing a movie on the camera) starts once the camera enters the shooting standby. When the

captured data fills the buffering capacity, old data is overwritten sequentially. When you press the MOVIE button, the camera starts to record a movie of the set duration calculated retroactively from that point on the memory card.

- With [End Trigger], a movie of the maximum possible duration is recorded. With [End Trigger Half], a movie of half the maximum possible duration is recorded. With [End Trigger Half], the time it takes to record to the memory card is also shorter than with [End Trigger].

End Trigger

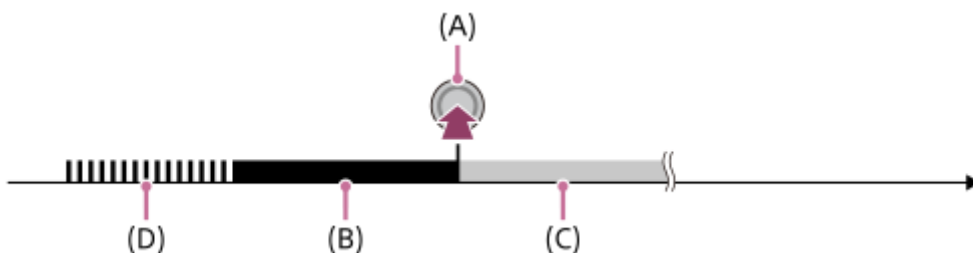

End Trigger Half

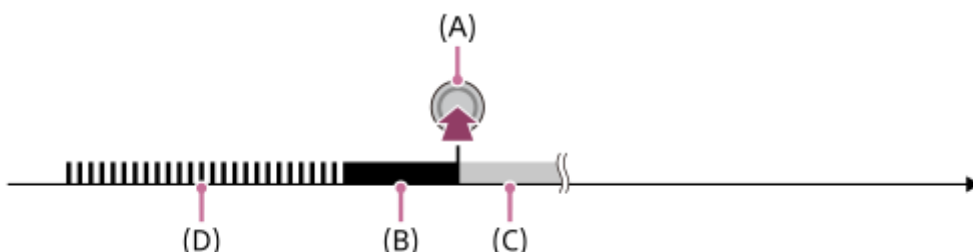

- (A): The point when the MOVIE button is pressed
- (B): Recorded section
- (C): Recording to memory card in progress (You cannot start the next session of shooting.)
- (D): Buffering in progress

To redo shooting

You can cancel recording by selecting [Cancel] on the screen. However, the movie recorded up to the point you cancelled will be saved.

Playback speed

The playback speed will vary as below depending on the assigned [HFR Frame Rate] and [HFR Record Setting].

HFR Frame Rate	HFR Record Setting: 24p 50M*	HFR Record Setting: 30p 50M/25p 50M	HFR Record Setting: 60p 50M/50p 50M
240fps/250fps	10 times slower	8 times slower/10 times slower	4 times slower/5 times slower
480fps/500fps	20 times slower	16 times slower/20 times slower	8 times slower/10 times slower
960fps/1000fps	40 times slower	32 times slower/40 times slower	16 times slower/20 times slower

* Only when [NTSC/PAL Selector] is set to NTSC.

[HFR Priority Setting] and shooting duration

HFR Priority Setting	HFR Frame Rate	Effective pixel number read out from image sensor	Shooting duration
Quality Priority	240fps/250fps	1824×1026	Approx. 2 seconds
Quality Priority	480fps/500fps	1824×616	Approx. 1 seconds
Quality Priority	960fps/1000fps	1244×420	Approx. 1 seconds

HFR Priority Setting	HFR Frame Rate	Effective pixel number read out from image sensor	Shooting duration
Shoot Time Priority	240fps/250fps	1824×616	Approx. 3 seconds
Shoot Time Priority	480fps/500fps	1292×436	Approx. 3 seconds
Shoot Time Priority	960fps/1000fps	912×308	Approx. 3 seconds

Playback time

For example, if you shoot for approx. 4 seconds with [**HFR** Record Setting] set to [24p 50M]*, [**HFR** Frame Rate] set to [960fps], and [**HFR** Priority Setting] set to [Shoot Time Priority], the playback speed will be 40 times slower and the playback time will be approx. 160 seconds (approx. 2 minutes and 40 seconds).

* Only when [NTSC/PAL Selector] is set to NTSC.

Note

- Sound will not be recorded.
- The movie will be recorded in XAVC S HD format.
- It may take time for recording to finish after you press the MOVIE button. Wait until the camera enters the shooting standby to start the next session of shooting.

Related Topic

- [HFR \(High Frame Rate\): Exposure Mode](#)

Digital Camera
ZV-1

Quality(Dual Rec)

Selects the quality of still images to be shot while recording movies.

1 MENU →  2 (Camera Settings2) → [Quality(Dual Rec)] → desired setting.

Menu item details

Extra fine/Fine/Standard

Digital Camera
ZV-1

Img. Size(Dual Rec)

Selects the size of still images to be shot while recording movies.



1 MENU →  2 (Camera Settings2) → [Img. Size(Dual Rec)] → desired setting.

Menu item details

L: 17M/M: 7.5M/S: 4.2M

Auto Dual Rec

Sets whether or not to automatically shoot still images when shooting movies. Shoots when impressive compositions, including people, are detected. This function may also record versions of the automatically shot images that have been trimmed into optimal compositions. When a trimmed image is recorded, both the image before trimming and the trimmed image will be recorded.

- 1 **MENU** →  **2 (Camera Settings2)** → **[Auto Dual Rec]** → **desired setting.**
- 2 **Press the MOVIE button to start movie recording.**
 - Still images will be shot automatically. While capturing a still image, the message [CAPTURE] is displayed on the monitor.
- 3 **Press the MOVIE button again to finish movie recording.**
 - To view the movies and still images recorded, press the  (Playback) button.

Menu item details

Off:

Auto Dual Rec is not performed.

On: Shoot. Frequency Low/On: Shoot. Frequency Standard/On: Shoot. Frequency High:

Auto Dual Rec is performed with the specified shooting frequency.

- The positions, orientation, expressions of faces are detected in order to shoot still images with the impressive compositions.

Hint

- If you want to change the size or quality of still images, use MENU →  **2 (Camera Settings2)** → [Img. Size(Dual Rec)]/[Quality(Dual Rec)].
- Even when [Auto Dual Rec] is set to On, you can record still images by pressing the shutter button.

Note

- Depending on the recording conditions, still images may not be shot with the optimal timing.
- Auto Dual Rec is unavailable when shooting movies vertically.



Related Topic

- [Capturing still images while recording movies \(Dual Rec\)](#)
- [Quality\(Dual Rec\)](#)
- [Img. Size\(Dual Rec\)](#)

Digital Camera
ZV-1

Proxy Recording

Sets whether to simultaneously record low-bit-rate proxy movies when recording XAVC S movies. Since proxy movies are small in file size, they are suitable for transferring to smartphones or uploading to websites.

1 MENU →  2 (Camera Settings2) → [ Proxy Recording] → desired setting.

Menu item details

On :

Proxy movies are simultaneously recorded.



Off :

Proxy movies are not recorded.

Hint

- Proxy movies are recorded in the XAVC S HD format (1280×720) at 9 Mbps. The frame rate of the proxy movie is the same as that of the original movie.
- Proxy movies are not displayed on the playback screen (single-image playback screen or image index screen).  (Proxy) is displayed over movies for which a proxy movie was simultaneously recorded.

Note



- Proxy movies cannot be played back on this camera.
- Proxy recording is not available in the following situations.
 - When [ File Format] is set to [AVCHD]
 - When [ File Format] is set to [XAVC S HD] and [ Record Setting] is set to [120p]/[100p]
- Deleting/protecting movies that have proxy movies removes/protects both the original and proxy movies. You cannot delete/protect only original movies or proxy movies.
- Movies cannot be edited on this camera.

Related Topic

- [Send to Smartphone Func.: Sending Target \(proxy movies\)](#)
- [Movie recording formats](#)
- [Playing back images on the image index screen \(Image Index\)](#)
- [Memory cards that can be used](#)

AF drive speed (movie)

You can switch focusing speed when using autofocus in movie mode.

1 MENU →  2 (Camera Settings2) → [ AF drive speed] → desired setting.

Menu item details

Fast:

Sets the AF drive speed to fast. This mode is suitable for shooting active scenes, such as sports.

Normal:

Sets the AF drive speed to normal.

Slow:



Sets the AF drive speed to slow. With this mode, the focus switches smoothly when the subject to be focused is changed.

Note

- When [ Record Setting] is set to [120p]/[100p], [ AF drive speed] cannot be used.

AF Tracking Sens. (movie)

You can set the AF sensitivity in movie mode.

1 MENU →  2 (Camera Settings2) →  AF Tracking Sens.] → desired setting.

Menu item details



Responsive:

Sets the AF sensitivity to high. This mode is useful when recording movies in which the subject is moving quickly.

Standard:

Sets the AF sensitivity to normal. This mode is useful when there are obstacles in front of the subject or in crowded places.



Note

- When  Record Setting] is set to [120p]/[100p],  AF Tracking Sens.] cannot be used.

Digital Camera
ZV-1

Auto Slow Shutter (movie)

Sets whether or not to adjust the shutter speed automatically when recording movies if the subject is dark.

1 MENU →  2 (Camera Settings2) → [ Auto Slow Shutter] → desired setting.

Menu item details



On:

Uses Auto Slow Shutter. The shutter speed automatically slows when recording in dark locations. You can reduce noise in the movie by using a slow shutter speed when recording in dark locations.

Off:

Does not use Auto Slow Shutter. The recorded movie will be darker than when [On] is selected, but you can record movies with smoother motion and less object blur.



Note

- [ Auto Slow Shutter] does not function in the following situations:
 - During High Frame Rate shooting
 -  S (Shutter Priority)
 -  M (Manual Exposure)
 - When [ISO] is set to other than [ISO AUTO]

Digital Camera
ZV-1

Initial Focus Mag. (movie)

Sets the initial magnification scale for [Focus Magnifier] in the movie shooting mode.

1 MENU →  2 (Camera Settings2) → [ Initial Focus Mag.] → **desired setting.**

Menu item details

x1.0:

Displays the image with the same magnification as the shooting screen.

x4.0:

Displays a 4.0-times enlarged image.

Related Topic

- [Focus Magnifier](#)

Digital Camera
ZV-1

Audio Recording

Sets whether to record sounds when shooting movies. Select [Off] to avoid recording the sounds of the lens and the camera operating.

1 MENU →  2 (Camera Settings2) → [Audio Recording] → desired setting.

Menu item details

On:

Records sound (stereo).

Off:

Does not record sound.

Digital Camera
ZV-1

Audio Rec Level

You can adjust the audio recording level while checking the level meter.

- 1 MENU →  2 (Camera Settings2) → [Audio Rec Level].
- 2 Select the desired level using the right/left sides of the control wheel.

Menu item details

+:

Turns up the audio recording level.

-:

Turns down the audio recording level.

Reset:

Resets the audio recording level to the default setting.

Hint

- When you record audio movies with loud volumes, set [Audio Rec Level] to a lower sound level. Doing so enables you to record more realistic audio. When you record audio movies with lower volumes, set [Audio Rec Level] to a greater sound level to make the sound easier to hear.
- The [Audio Rec Level] settings are applied for both the internal microphone and the  (microphone) terminal input.

Note

- Regardless of the [Audio Rec Level] settings, the limiter always operates.
- [Audio Rec Level] is available only when the shooting mode is set to movie mode.
- [Audio Rec Level] is unavailable during High Frame Rate shooting.

Audio Level Display

Sets whether to display the audio level on the screen.

1 MENU →  2 (Camera Settings2) → [Audio Level Display] → desired setting.

Menu item details

On:

Displays the audio level.

Off:

Does not display the audio level.

Note

- The audio level is not displayed in the following situations:
 - When [Audio Recording] is set to [Off].
 - When DISP (Display Setting) is set to [No Disp. Info.].
 - During High Frame Rate shooting
- The audio level is also displayed while shooting stand-by in movie recording mode.

Digital Camera
ZV-1

Wind Noise Reduct.

Sets whether or not to reduce wind noise by cutting the low-range sound of the input audio from the built-in microphone.

1 MENU →  2 (Camera Settings2) → [Wind Noise Reduct.] → desired setting.

Menu item details

On:

Reduces wind noise.

Off:

Does not reduce wind noise.



Hint



- Wind noise may also be reduced by attaching the wind screen (supplied).

Note

- Setting this item to [On] where wind is not blowing sufficiently hard may cause normal sound to be recorded with too low volume.
- When an external microphone (sold separately) is used, [Wind Noise Reduct.] does not function.

SteadyShot (movie)

Sets [ SteadyShot] effect when shooting movies. If you set the [ SteadyShot] effect to [Off] when using a tripod (sold separately), a natural image is produced.

1 MENU →  2 (Camera Settings2) → [ SteadyShot] → desired setting.

Menu item details

Active:

Provides a more powerful SteadyShot effect.

Standard:

Reduces camera shake under stable movie shooting conditions.

Off:

Does not use [ SteadyShot].

Note



- If you change the setting for [ SteadyShot], the angle of view will change.

Related Topic

- [SteadyShot \(still image\)](#)

Marker Display (movie)

Sets whether or not to display markers set using [ Marker Settings] on the monitor while shooting movies.

1 MENU →  (Camera Settings2) → [ Marker Display] → **desired setting.**

Menu item details

On:

Markers are displayed. The markers are not recorded.

Off:

No marker is displayed.

Note

- The markers are displayed during movie shooting standby, or while recording movies.
- You cannot display markers when using [Focus Magnifier].
- The markers are displayed on the monitor. (You cannot output the markers.)



Related Topic

- [Marker Settings \(movie\)](#)

Digital Camera
ZV-1

Marker Settings (movie)

Sets the markers to be displayed while shooting movies.

1 MENU →  2 (Camera Settings2) → [ Marker Settings] → desired setting.

Menu item details

Center:

Sets whether or not to display the center marker in the center of the shooting screen.

[Off]/[On]

Aspect:

Sets the aspect marker display.

[Off]/[4:3]/[13:9]/[14:9]/[15:9]/[1.66:1]/[1.85:1]/[2.35:1]

Safety Zone:

Sets the safety zone display. This becomes the standard range that can be received by a general household TV.

[Off]/[80%]/[90%]

Guideframe:

Sets whether or not to display the guide frame. You can verify whether the subject is level or perpendicular to the ground.

[Off]/[On]

Hint

- You can display several markers at the same time.
- Place the subject on the cross point of the [Guideframe] to make a balanced composition.

Digital Camera
ZV-1

REC Lamp

You can choose whether or not the recording lamp lights up during recording.

1 MENU →  2 (Camera Settings2) → [REC Lamp] → desired setting.

Menu item details

On:

The recording lamp lights up during recording.

Off:

The recording lamp does not light up during recording.

Hint

- Set [REC Lamp] to [Off] if the light of the recording lamp reflected by an object, such as glass, is captured by the camera.

Digital Camera
ZV-1

Movie w/ shutter

You can start or stop recording movies by pressing the shutter button instead of the MOVIE (Movie) button.

1 MENU →  2 (Camera Settings2) → [Movie w/ shutter] → desired setting.

Menu item details

On:
Enables movie recording using the shutter button when the shooting mode is set to [Movie] or [ Intelligent Auto], or during High Frame Rate shooting.

Off:
Disables movie recording using the shutter button.

Hint



- When [Movie w/ shutter] is set to [On], you can still start or stop recording movies using the MOVIE button.
- When [Movie w/ shutter] is set to [On], you can use the shutter button to start or stop recording movies on an external recording/playback device using [ REC Control].

Related Topic

- [Shooting movies](#)

Shutter Type (still image)

You can set whether to shoot with a mechanical shutter or an electronic shutter.

1 MENU →  2 (Camera Settings2) → [ Shutter Type] → desired setting.

Menu item details

Auto:

The shutter type is automatically switched based on the shooting conditions and shutter speed.



Mechanical Shutter:

Shoot with the mechanical shutter only.





Electronic Shutter:

Shoot with the electronic shutter only.

Hint

- In the following situations, set the [ Shutter Type] to [Auto] or [Electronic Shutter].
 - When shooting with a high-speed shutter in a bright environment such as outside in bright sunlight, the beach, or snowy mountains.
 - When you want to increase the speed of continuous shooting.
- In the following situations, set the [ Shutter Type] to [Auto] or [Mechanical Shutter].
 - When you want to use the flash with a shutter speed faster than 1/100 second.
 - When you are concerned about distortion in the image due to the movement of the subject or the movement of the camera.

Note

- When shooting with the electronic shutter, there may be distortion in the image due to the movement of the subject or the camera itself.
- During shooting with the electronic shutter, band-like light-and-dark shading may appear when shooting under flickering light such as fluorescent light or instantaneous light (such as the flash of another camera).
- In rare cases, the shutter sound may be produced when the power is turned off even if the [ Shutter Type] is set to [Electronic Shutter]. However, this is not a malfunction.
- In the following situations, the mechanical shutter will be activated even if the [ Shutter Type] is set to [Electronic Shutter].
 - When capturing a standard white color for the custom white balance
 - [Face Registration]
- The following functions are unavailable when the [ Shutter Type] is set to [Electronic Shutter].
 -  Long Exposure NR
 - Bulb shooting
- When using an external flash, the highest shutter speed you can set is 1/4000 seconds. However, because this shutter speed uses the electronic shutter, a belt-like contrast may be recorded on the image. If this occurs, set the [ Shutter Type] to [Mechanical Shutter].

Digital Camera
ZV-1

Release w/o Card

Sets whether the shutter can be released when no memory card has been inserted.

1 MENU →  2 (Camera Settings2) → [Release w/o Card] → desired setting.

Menu item details

Enable:

Releases the shutter even if no memory card has been inserted.

Disable:

Does not release the shutter when no memory card has been inserted.



Note

- When no memory card has been inserted, the images shot will not be saved.
- The default setting is [Enable]. It is recommended that you select [Disable] prior to actual shooting.

Digital Camera
ZV-1

SteadyShot (still image)

Sets whether or not to use the SteadyShot function.

1 MENU →  2 (Camera Settings2) → [ SteadyShot] → desired setting.

Menu item details

On:

Uses [ SteadyShot].

Off:

Does not use [ SteadyShot].

We recommend that you set the camera to [Off] when using a tripod.

Related Topic

- [SteadyShot \(movie\)](#)

Digital Camera
ZV-1

Zoom Setting

You can select the zoom setting of the product.

1 MENU →  2 (Camera Settings2) → [Zoom Setting] → desired setting.

Menu item details

Optical zoom only:

Limits the zoom range to the optical zoom. You can use the Smart Zoom function if you set [ JPEG Image Size] to [M], [S] or [VGA].

ClearImage Zoom :

Select this setting to use Clear Image Zoom. Even if the zoom range exceeds the optical zoom, the product magnifies images using an image process with less deterioration.

Digital Zoom :

When the zoom range of the Clear Image Zoom is exceeded, the product magnifies images to the largest scale. However, the image quality will deteriorate.

Note

- Set [Optical zoom only] if you want to magnify images within the range in which image quality does not deteriorate.

Related Topic

- [The zoom features available with this product](#)
- [About zoom scale](#)

Digital Camera
ZV-1

Zoom Speed

Sets the zoom speed of the camera's zoom lever.

1 MENU →  2 (Camera Settings2) → [Zoom Speed] → desired setting.

Menu item details

Normal:

Sets the zoom speed of the zoom lever to normal.

Fast:

Sets the zoom speed of the zoom lever to fast.

Hint

- The [Zoom Speed] settings are also used when you are zooming with a remote controller (sold separately) connected to the camera.

Note

- Selecting [Fast] increases the likelihood that the zoom sound will be recorded.

Related Topic

- [Zoom](#)

Digital Camera
ZV-1

DISP Button

Allows you to set the screen display modes that can be selected using DISP (Display Setting) in shooting mode.

1 MENU →  2 (Camera Settings2) → [DISP Button] → desired setting → [Enter].

The items marked with ✓ (check mark) are available.

Menu item details

Graphic Display :

Shows basic shooting information. Graphically shows the shutter speed and aperture value.

Display All Info. :

Shows recording information.

No Disp. Info. :

Does not show recording information.

Histogram :

Displays the luminance distribution graphically.

Level :

Indicates whether the product is level in both the front-back **(A)** and horizontal **(B)** directions. When the product is level in either direction, the indicator turns to green.

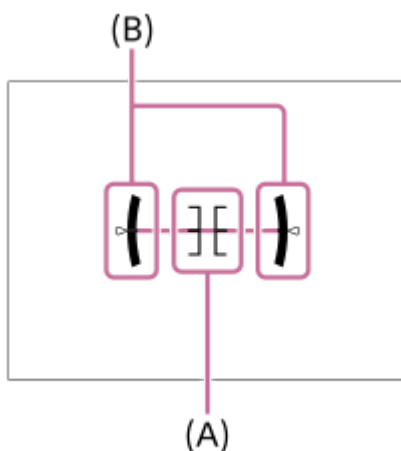

Note

- If you tilt the product forward or backward by a large degree, the level error will be great.
- The product may have a margin of error of almost $\pm 1^\circ$ even when the inclination is corrected by the level.

Related Topic

- [Switching the screen display \(while shooting/during playback\)](#)

Digital Camera
ZV-1

Zebra Setting

Sets a zebra pattern, which appears over part of an image if the brightness level of that part meets the IRE level that you have set. Use this zebra pattern as a guide to adjust the brightness.

1 MENU →  2 (Camera Settings2) → [Zebra Setting] → desired setting.

Menu item details

Zebra Display:

Sets whether to display the zebra pattern.

Zebra Level:

Adjusts the brightness level of the zebra pattern.

Hint

- You can register values to check the correct exposure or overexposure as well as the brightness level for [Zebra Level]. The settings for correct exposure confirmation and overexposure confirmation are registered to [Custom1] and [Custom2] respectively in the default settings.
- To check the correct exposure, set a standard value and the range for the brightness level. The zebra pattern will appear on areas that fall within the range you set.
- To check the overexposure, set a minimum value for the brightness level. The zebra pattern will appear over areas with a brightness level equal to or higher than the value you set.

Note

- The zebra pattern is not displayed on devices connected via HDMI.

Grid Line

Sets whether the grid line is displayed or not. The grid line will help you to adjust the composition of images.

1 MENU →  2 (Camera Settings2) → [Grid Line] → **desired setting.**

Menu item details

Rule of 3rds Grid:

Place main subjects close to one of the grid lines that divide the image into thirds for a well-balanced composition.

Square Grid:

Square grids make it easier to confirm the horizontal level of your composition. This is useful for assessing the composition when shooting landscapes, closeups, or when performing camera scanning.

Diag. + Square Grid:

Place a subject on the diagonal line to express an uplifting and powerful feeling.

Off:

Does not display the grid line.

Digital Camera
ZV-1

Exposure Set. Guide

You can set whether to display a guide when you change the exposure.

1 MENU →  2 (Camera Settings2) → [Exposure Set. Guide] → desired setting.

Menu item details

Off:

Does not display the guide.

On:

Displays the guide.

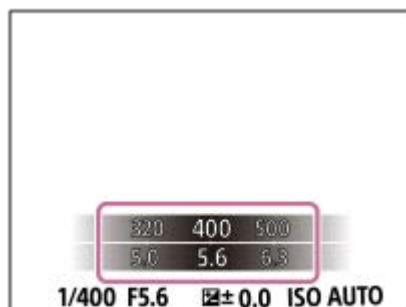

Digital Camera
ZV-1

Live View Display

Sets whether or not to show images altered with effects of the exposure compensation, white balance, [Creative Style], or [Picture Effect] on the screen.

1 MENU →  2 (Camera Settings2) → [Live View Display] → desired setting.

Menu item details

Setting Effect ON:

Displays Live View in conditions close to what your picture will look like as a result of applying all your settings. This setting is useful when you want to shoot pictures while checking the results of the shot on the Live View screen.

Setting Effect OFF:

Displays Live View without the effects of exposure compensation, white balance, [Creative Style], or [Picture Effect]. When this setting is used, you can easily check the image composition.

Live View is always displayed with the appropriate brightness even in [Manual Exposure] mode.

When [Setting Effect OFF] is selected, the **VIEW** (VIEW) icon is displayed on the Live View screen.

Hint

- When you use a third-party flash, such as a studio flash, Live View Display may be dark for some shutter speed settings. When [Live View Display] is set to [Setting Effect OFF], Live View Display will be displayed brightly, so that you can easily check the composition.

Note

- [Live View Display] cannot be set to [Setting Effect OFF] in the following shooting modes:
 - [Intelligent Auto]
 - [Sweep Panorama]
 - [Movie]
 - [High Frame Rate]
 - [Scene Selection]
 - [ Intelligent Auto]
- When [Live View Display] is set to [Setting Effect OFF], the brightness of the shot image will not be the same as that of the displayed Live View.

Digital Camera
ZV-1

Auto Review

You can check the recorded image on the screen right after the shooting. You can also set the display time for Auto Review.

1 MENU →  2 (Camera Settings2) → [Auto Review] → desired setting.

Menu item details

10 Sec/5 Sec/2 Sec:

Displays the recorded image on the screen right after shooting for the selected duration of time. If you perform a magnifying operation during Auto Review, you can check that image using the magnified scale.

Off:

Does not display the Auto Review.

Note



- When you use a function that performs image processing, the image before processing may be displayed temporarily, followed by the image after processing.
- The DISP (Display Setting) settings are applied for the Auto Review display.

Related Topic

- [Enlarging an image being played back \(Enlarge Image\)](#)

Assigning frequently used functions to buttons (Custom Key)

You can use the custom key function to assign the functions you use most frequently to easily operable keys. This lets you skip the process of selecting items from MENU, so you can recall the functions more quickly. You can also assign [Not set] to easily operable keys to prevent accidental operation.

You can separately assign functions to custom keys for the still image shooting mode ( Custom Key), movie shooting mode ( Custom Key), and playback mode ( Custom Key).

- Assignable functions vary depending on the keys.

You can assign functions to the following keys.

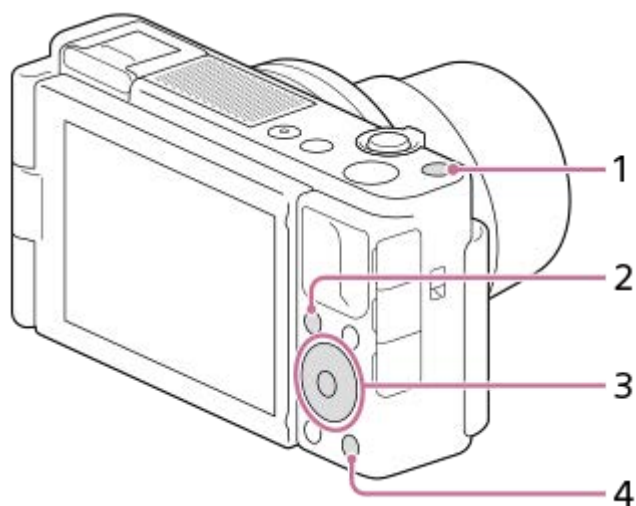





1. Custom Button 1
2. Fn/  Button
3. Center Button /Left Button/Right Button
4. Custom Button 2

Hint







- You can recall functions more quickly by using the Function menu to configure each setting directly from the Fn button, along with the custom keys. Refer to the related functions under “Related Topic” at the bottom of this page.

The following is the procedure for assigning the [Eye AF] function to the C2 button.

- 1** MENU →  2 (Camera Settings2) → [ Custom Key].
 - If you want to assign a function to recall while shooting movies, select [ Custom Key]. If you want to assign a function to recall while playing back images, select [ Custom Key].
- 2** Move to the [Rear] screen using the left/right side of the control wheel. Then, select [Custom Button 2] and press the center of the control wheel.
- 3** Press the left/right side of the control wheel until [Eye AF] is displayed. Select [Eye AF], and then press the center.

- If you press the C2 button in the still image shooting mode and eyes are detected, [Eye AF] will activate, and the camera will focus on the eyes. Shoot images while holding down the C2 button.

Note

- If you assign [Follow Custom ()] to a custom key using [ Custom Key], but the function is one that is unavailable in the movie shooting mode such as [ JPEG Quality] or [Flash Mode], the function will not be recalled when you press the key in the movie shooting mode.
- If you assign [Follow Custom ( / )] to a custom key using [ Custom Key], the camera will switch to the shooting mode and recall the assigned function when you press the key in the playback mode.

Related Topic

- [Using Fn \(Function\) button \(Function menu\)](#)

Using Fn (Function) button (Function menu)

The Function menu is a menu of 12 functions that is displayed at the bottom of the screen when you press the Fn (Function) button in the shooting mode. You can access frequently used functions more quickly by registering them to the function menu.



Hint

- You can register twelve functions to the Function menus for still image shooting and movie shooting, respectively.
- You can recall functions more quickly by using the custom key function to assign frequently used functions to desired keys, along with the function menu. Refer to the related functions under “Related Topic” at the bottom of this page.

1 Press the Fn (Function) button in shooting mode.

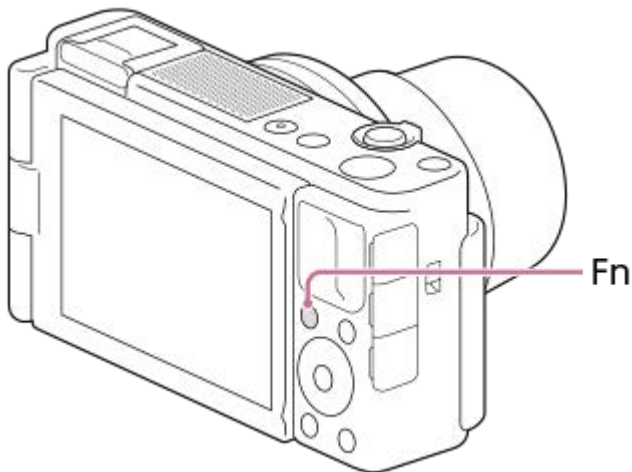

2 Select the desired function by pressing the top/bottom/left/right side of the control wheel.

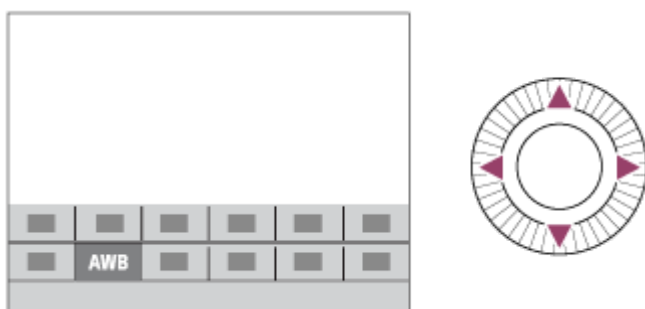

- 3 Select the desired setting by turning the control wheel, and press the center of the control wheel.

To adjust settings from the dedicated setting screens

Select the desired function in step 2, then press the center of the control wheel. The dedicated setting screen for the function will appear. Follow the operating guide **(A)** to adjust settings.

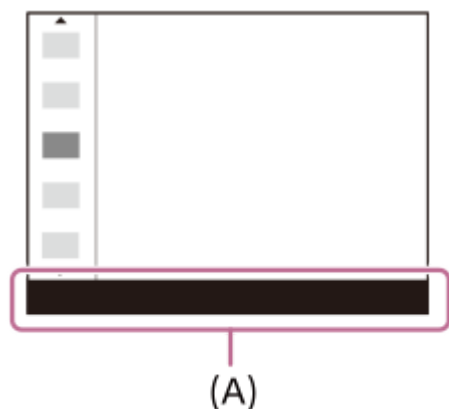

To change the functions in the function menu (Function Menu Set.)

The following is the procedure for changing [Drive Mode] in the still image function menu to [Grid Line].

- To change the movie function menu, select a movie function menu item in Step 2.
1. MENU → 2 (Camera Settings2) → [Function Menu Set.].
 2. Select (Drive Mode) from among the twelve still image function menu items using the top/bottom/left/right side of the control wheel, and then press the center.
 3. Move to the [Display/Auto Review] screen using the left/right side of the control wheel. Then, select [Grid Line] and press the center of the control wheel.
 - (Grid Line) will be displayed in the former location of (Drive Mode) in the function menu.

Related Topic

- [Assigning frequently used functions to buttons \(Custom Key\)](#)

Func. of Touch Operation: Touch Shutter

The camera automatically focuses on the point you touch and shoots a still image.

Set MENU →  (Setup) → [Touch Operation] to [On] in advance.

1 Select MENU →  2 (Camera Settings2) → [Func. of Touch Operation] → [Touch Shutter].

2 Touch the  icon inside the rectangle in the top right of the monitor while the shooting screen is displayed.

The mark to the left of the icon turns orange, and the touch shutter function is activated.

- To cancel [Touch Shutter], touch the  icon again.
- The touch shutter function is canceled when the camera is restarted.

3 Touch the subject to focus on.

The camera focuses on the subject you touched, and a still image is recorded.

Hint

- You can operate the shooting functions below by touching the monitor:
 - Shooting burst images using the touch shutter
When [Drive Mode] is set to [Cont. Shooting], you can record burst images while touching the monitor.
 - Shooting burst images of sports scenes using the touch shutter
When [Scene Selection] is set to [Sports Action], you can record burst images while touching the monitor.
 - Shooting continuous bracket images using the touch shutter
The product shoots three images while automatically shifting the exposure from base, to darker, and then to lighter. When [Drive Mode] is set to [Cont. Bracket], keep touching the monitor until the shooting ends. After the recording you can select the image you prefer.

Note

- The [Touch Shutter] function is unavailable in the following situations:
 - When shooting movies
 - When the shooting mode is set to [Sweep Panorama]
 - During [Smile Shutter] mode
 - When [Focus Mode] is [Manual Focus]
 - When [Focus Area] is [Flexible Spot]
 - When [Focus Area] is [Expand Flexible Spot]
 - When [Focus Area] is [Tracking: Flexible Spot]
 - When [Focus Area] is [Tracking: Expand Flexible Spot]
 - While using the digital zoom function
 - While using the  Clear Image Zoom]

Related Topic

- [Touch Operation](#)

Func. of Touch Operation: Touch Focus

[Touch Focus] allows you to specify a position where you want to focus using touch operations. This function is available when [Focus Area] is set to a parameter other than [Flexible Spot], [Expand Flexible Spot], [Tracking: Flexible Spot] or [Tracking: Expand Flexible Spot]. Select MENU →  (Setup) → [Touch Operation] → [On] beforehand.

1 MENU →  (Camera Settings2) → [Func. of Touch Operation] → [Touch Focus].

Specifying the position where you want to focus in the still image mode

You can specify a position where you want to focus using touch operations. After touching the monitor and specifying a position, press the shutter button halfway down to focus.

1. Touch the monitor.
 - Touch the subject to focus.
 - To cancel focusing with touch operations, touch the  (Focus Cancel) icon or press the center of the control wheel.
2. Press the shutter button halfway down to focus.
 - Press the shutter button all the way down to shoot images.

Specifying the position where you want to focus in the movie recording mode (spot focus)

The camera will focus on the touched subject.

1. Touch the subject on which you want to focus before or during recording.
 - To cancel spot focus, touch the  (Focus Cancel) icon or press the center of the control wheel.

Hint

- In addition to the touch focus function, touch operations such as the following are also available.
 - When [Focus Area] is set to [Flexible Spot], [Expand Flexible Spot], [Tracking: Flexible Spot] or [Tracking: Expand Flexible Spot], the focusing frame can be moved using touch operations.
 - When the [Focus Mode] is set to [Manual Focus], the focus magnifier can be used by double-tapping the monitor.

Note

- The touch focus function is not available in the following situations:
 - When the shooting mode is set to [Sweep Panorama].
 - When [Focus Mode] is set to [Manual Focus].
 - When using the digital zoom

Related Topic

- [Touch Operation](#)

Func. of Touch Operation: Touch Tracking



You can use touch operations to select a subject you want to track in the still image and movie recording modes.
Select MENU →  (Setup) → [Touch Operation] → [On] in advance.

- 1 MENU →  2 (Camera Settings2) → [Func. of Touch Operation] → [Touch Tracking].
- 2 Touch the subject that you want to track on the monitor.
Tracking will start.
- 3 Press the shutter button halfway down to focus.
 - Press the shutter button all the way down to shoot images.

Hint

- To cancel tracking, touch the  (Tracking Cancel) icon or press the center of the control wheel.

Note

- [Touch Tracking] is unavailable in the following situations:
 - When [Scene Selection] is [Hand-held Twilight] or [Anti Motion Blur].
 - When shooting movies with [ Record Setting] set to [120p]/[100p].
 - When shooting mode is set to [Sweep Panorama].
 - When [Focus Mode] is set to [Manual Focus] or [DMF]
 - When using the Smart Zoom, Clear Image Zoom and Digital Zoom
 - When [Subject Detection] under [Face/Eye AF Set.] is set to [Animal]
 - When [ File Format] is set to [XAVC S 4K] and [ Proxy Recording] is set to [On]

Related Topic

- [Touch Operation](#)

Digital Camera
ZV-1

MOVIE Button

Sets whether or not to activate the MOVIE (Movie) button.

1 MENU →  2 (Camera Settings2) → [MOVIE Button] → desired setting.

Menu item details

Always:

Starts movie recording when you press the MOVIE button in any mode. (except when the shooting mode is set to **HFR** (High Frame Rate).)

Movie Mode Only:

Starts movie recording when you press the MOVIE button only if the shooting mode is set to [Movie] or [ Intelligent Auto].

Digital Camera
ZV-1

Audio signals

Selects whether the product produces a sound or not.

1 MENU →  2 (Camera Settings2) → [Audio signals] → desired setting.

Menu item details

On:all:

Sounds are produced for example when the focus is achieved by pressing the shutter button halfway down.

On:Shutter Only:

Only the shutter sound is produced.

Off:



Sounds are not produced.

Note

- If [Focus Mode] is set to [Continuous AF], the camera will not beep when it focuses on a subject.

Write Date (still image)

Sets whether to record a shooting date on the still image.

1 MENU →  2 (Camera Settings2) → [ Write Date] → desired setting.

Menu item details

On:

Records a shooting date.

Off:

Does not record a shooting date.

Note

- If you shoot images with the date once, you cannot delete the date from the images later.
- The dates are doubly printed if you set the product to print dates when printing the images using PCs or printers.
- The recorded time of the image cannot be superimposed on the image.
- [ Write Date] is not available for RAW images.

Send to Smartphone Func.: Send to Smartphone

You can transfer still images, XAVC S movies, or high-frame-rate movies to a smartphone and view them. The application Imaging Edge Mobile must be installed on your smartphone.

1 MENU → (Network) → [Send to Smartphone Func.] → [Send to Smartphone] → desired setting.

- If you press the  (Send to Smartphone) button in playback mode, the setting screen for [Send to Smartphone] will appear.

2 If the product is ready for the transfer, the information screen appears on the product. Connect the smartphone and the product using that information.

- The setting method for connecting the smartphone and the product varies depending on the smartphone.



Menu item details

Select on This Device:

Selects an image on the product to be transferred to the smartphone.

(1) Select from among [This Image], [All with this date] or [Multiple Images].

- The options displayed may differ depending on the View Mode selected on the camera.

(2) If you select [Multiple Images], select the desired images using the center of the control wheel, then press MENU → [Enter].

Select on Smartphone:

Displays all images recorded on the product's memory card on the smartphone.

Note

- You can only transfer images that are saved on the camera's memory card.
- You can select an image size to be sent to the smartphone from [Original], [2M] or [VGA]. To change the image size, refer to the following steps.
 - For Android smartphone
Start Imaging Edge Mobile, and change the image size by [Settings] → [Copy Image Size].
 - For iPhone/iPad
Select Imaging Edge Mobile in the setting menu, and change the image size by [Copy Image Size].
- RAW images are converted to JPEG format when they are sent.
- You cannot send AVCHD format movies.
- Depending on the smartphone, the transferred movie may not be played back correctly. For example, the movie may not play smoothly, or there may be no sound.

- Depending on the format of the still image, movie, or high-frame-rate movie, it may not be possible to play it back on a smartphone.
- This product shares the connection information for [Send to Smartphone] with a device that has permission to connect. If you want to change the device that is permitted to connect to the product, reset the connection information by following these steps. MENU →  (Network) → [Wi-Fi Settings] → [SSID/PW Reset]. After resetting the connection information, you must register the smartphone again.
- When [Airplane Mode] is set to [On], you cannot connect this product and the smartphone. Set [Airplane Mode] to [Off].
- While you transfer large numbers of images or long movies, we recommend that you supply power to the camera from a wall outlet (wall socket) using an AC adaptor, etc.



Related Topic

- [Imaging Edge Mobile](#)
- [Controlling the camera using an Android smartphone \(QR Code\)](#)
- [Controlling the camera using an Android smartphone \(SSID\)](#)
- [Controlling the camera using an iPhone or iPad \(QR Code\)](#)
- [Controlling the camera using an iPhone or iPad \(SSID\)](#)
- [Send to Smartphone Func.: Sending Target \(proxy movies\)](#)
- [Airplane Mode](#)

Digital Camera
ZV-1

Send to Smartphone Func.: Sending Target (proxy movies)

When transferring XAVC S video to a smartphone with [Send to Smartphone], you can set whether to transfer the low-bit-rate proxy movie or the high-bit-rate original movie.

1 MENU →  (Network) → [Send to Smartphone Func.] → [ Sending Target] → desired setting.

Menu item details

Proxy Only:

Transfers only proxy movies.

Original Only:

Transfers only original movies.

Proxy & Original:

Transfers both proxy and original movies.

Note

- While you transfer large numbers of images or long movies, we recommend that you supply power to the camera from a wall outlet (wall socket) using an AC adaptor, etc.

Related Topic

- [Send to Smartphone Func.: Send to Smartphone](#)
- [Proxy Recording](#)

Send to Smartphone Func.: Cnct. during Power OFF

Sets whether or not to accept Bluetooth connections from a smartphone while the camera is turned off. When [Cnct. during Power OFF] is set to [On], you can browse images on the camera's memory card and transfer images from the camera to a smartphone by operating the smartphone.

- 1 MENU →  (Network) → [Send to Smartphone Func.] → [Cnct. during Power OFF] → desired setting.

Menu Item Details

On :

Accepts Bluetooth connections from a smartphone while the camera is turned off.



The battery level is depleted gradually while the camera is turned off. If you do not want to use [Cnct. during Power OFF], turn it off.

Off :

Does not accept Bluetooth connections from a smartphone while the camera is turned off.

How to browse/transfer images on the smartphone

Advance Preparation

1. Select MENU →  (Network) → [Bluetooth Settings] → [Bluetooth Function] → [On] on the camera.
2. MENU →  (Network) → [Send to Smartphone Func.] → [Cnct. during Power OFF] → [On].
3. Select MENU →  (Network) → [Bluetooth Settings] → [Pairing] on the camera to display the screen for pairing.
4. Launch Imaging Edge Mobile on the smartphone, and then select the camera to be paired on the [Camera Remote Power ON/OFF] screen.

Operations

1. Turn off the camera.
2. Select the camera on the [Camera Remote Power ON/OFF] screen of Imaging Edge Mobile to turn on the camera.
 - The camera's power lamp will light up, and the browsing and transferring functions will become available.

Note

- If the smartphone is not operated for a certain period of time, the Bluetooth connection will become deactivated. Select [Camera Remote Power ON/OFF] again on the smartphone.
- When the camera is turned on, the camera switches to the shooting mode, and [Send to Smartphone Func.] ends.

Related Topic

- [Imaging Edge Mobile](#)
- [Send to Smartphone Func.: Send to Smartphone](#)
- [Bluetooth Settings](#)

Send to Computer

You can transfer images stored in the product to a computer connected to a wireless access point or wireless broadband router and easily make backup copies using this operation. Before starting this operation, install PlayMemories Home on your computer and register the access point on the product.

- 1 **Start your computer.**
- 2 **MENU** →  **(Network)** → **[Send to Computer]**.

Note

- Depending on the application settings of your computer, the product will turn off after saving the images to your computer.
- You can transfer images from the product to only one computer at a time.
- If you want to transfer images to another computer, connect the product and the computer via a USB connection and follow the instructions in PlayMemories Home.
- Proxy movies cannot be transferred.

Related Topic

- [Introduction to computer software \(PlayMemories Home/Imaging Edge\)](#)
- [Wi-Fi Settings: WPS Push](#)
- [Wi-Fi Settings: Access Point Set.](#)

Digital Camera
ZV-1

View on TV

You can view images on a network-enabled TV by transferring them from the product without connecting the product and TV with a cable. For some TVs, you may need to perform operations on the TV. For details, refer to the operating instructions supplied with the TV.

1 MENU →  (Network) → [View on TV] → **desired device to be connected.**

2 When you want to play back images using slideshow, press the center of the control wheel.

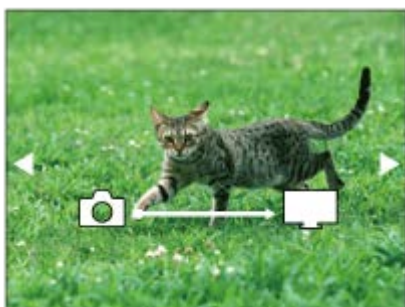

- To display the next/previous image manually, press the right/left sides of the control wheel.
- To change the device to be connected, press the down side of the control wheel, then select [Device list].

Slideshow settings

You can change the slideshow settings by pressing the down side of the control wheel.

Playback Selection:

Selects the group of images to be shown.

Folder View(Still):

Selects from [All] and [All in Folder].

Date View:

Selects from [All] and [All with this date].

Interval:

Selects from [Short] and [Long].

Effects*:

Selects from [On] and [Off].

Playback Image Size:

Selects from [HD] and [4K].

* The settings are effective only for BRAVIA TV which is compatible with the functions.

Note

- You can use this function on a TV that supports DLNA renderer.
- You can view images on a Wi-Fi Direct-enabled TV or network-enabled TV (including wired network-enabled TVs).
- If you connect TV and this product and do not use Wi-Fi Direct, you need to register your access point first.
- Displaying the images on the TV may take time.
- Movies cannot be shown on a TV via Wi-Fi. Use an HDMI cable (sold separately).
- When [Display as Group] is set to [On], only the first image of the group is transferred to the TV.

Related Topic

- [Wi-Fi Settings: WPS Push](#)
- [Wi-Fi Settings: Access Point Set.](#)

5-016-934-11(1) Copyright 2020 Sony Corporation

Digital Camera
ZV-1

Ctrl w/ Smartphone

Sets the condition for connecting the camera to a smartphone.

1 MENU →  (Network) → [Ctrl w/ Smartphone] → desired setting.

Menu item details

Ctrl w/ Smartphone:

Sets whether to connect the camera and a smartphone using Wi-Fi. ([On]/[Off])

Connection:

Displays the QR code or SSID used to connect the camera to a smartphone.

Always Connected:

Sets whether to keep the camera connected to a smartphone. If this item is set to [On], once you connect the camera to a smartphone, it will remain connected to the smartphone at all times. If it is set to [Off], the camera will connect to a smartphone only when the connection procedure is performed.

Note

- If [Always Connected] is set to [On], the power consumption will be greater than when it is set to [Off].

Related Topic

- [Controlling the camera using an Android smartphone \(QR Code\)](#)
- [Controlling the camera using an Android smartphone \(SSID\)](#)
- [Controlling the camera using an iPhone or iPad \(QR Code\)](#)
- [Controlling the camera using an iPhone or iPad \(SSID\)](#)
- [Send to Smartphone Func.: Send to Smartphone](#)

Operating the camera from a computer (PC Remote Function)

With a USB connection, you can control the camera from a computer, including such functions as shooting and storing images on the computer.

Select MENU →  (Network) → [Ctrl w/ Smartphone] → [Ctrl w/ Smartphone] → [Off] beforehand.

- 1 MENU →  (Network) → [PC Remote Function] → Select an item to set, and then select the desired setting.**
- 2 Connect the camera to the computer using the micro USB cable (supplied), and then launch Imaging Edge (Remote) on the computer.**

You can now operate the camera using Imaging Edge (Remote).

Menu item details

PC Remote:

Sets whether or not to use the [PC Remote] function. ([On] / [Off])

Still Img. Save Dest.:

Sets whether or not to save still images to both the camera and the computer during PC Remote shooting. ([PC Only]/[PC+Camera]/[Camera Only])

RAW+J PC Save Img:

Selects the file type for images to be transferred to the computer when [Still Img. Save Dest.] is set to [PC+Camera]. ([RAW & JPEG]/[JPEG Only]/[RAW Only])

Note

- When an unrecordable memory card is inserted into the camera, you cannot record still images even if [Still Img. Save Dest.] is set to [Camera Only] or [PC+Camera].
- When [Camera Only] or [PC+Camera] is selected and no memory card is inserted into the camera, the shutter will not be released even if [Release w/o Card] is set to [Enable].
- While a still image is being played back on the camera, you cannot shoot with [PC Remote].
- [RAW+J PC Save Img] can only be selected when [ File Format] is set to [RAW & JPEG].

Related Topic

- [Introduction to computer software \(PlayMemories Home/Imaging Edge\)](#)

Digital Camera
ZV-1

Airplane Mode

When you board an airplane, etc., you can temporarily disable all the wireless-related functions including Wi-Fi.

1 MENU →  (Network) → [Airplane Mode] → **desired setting.**

If you set [Airplane Mode] to [On], an airplane mark will be displayed on the screen.

Wi-Fi Settings: WPS Push

If your access point has a Wi-Fi Protected Setup (WPS) button, you can register the access point to this product easily.

- 1 MENU →  (Network) → [Wi-Fi Settings] → [WPS Push].
- 2 Push the Wi-Fi Protected Setup (WPS) button on the access point to connect.

Note

- [WPS Push] works only if the security setting of your access point is set to WPA or WPA2 and your access point supports the Wi-Fi Protected Setup (WPS) button method. If the security setting is set to WEP or your access point does not support the Wi-Fi Protected Setup (WPS) button method, perform [Access Point Set].
- For details about the available functions and settings of your access point, see the access point operating instructions or contact the administrator of the access point.
- A connection may not be possible or the communication distance may be shorter depending on the surrounding conditions, such as the type of wall material and the presence of obstructions or radio waves between the product and access point. In this case, change the location of the product or move the product closer to the access point.

Related Topic

- [Wi-Fi Settings: Access Point Set.](#)

Digital Camera
ZV-1

Wi-Fi Settings: Access Point Set.

You can register your access point manually. Before starting the procedure, check the SSID name of the access point, security system, and password. The password may be preset in some devices. For details, see the access point operating instructions, or consult the access point administrator.

1 MENU →  (Network) → [Wi-Fi Settings] → [Access Point Set.].

2 Select the access point you want to register.

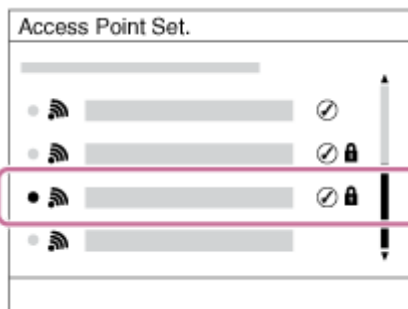

When the desired access point is displayed on the screen: Select the desired access point.

When the desired access point is not displayed on the screen: Select [Manual Setting] and set the access point.

- If you select [Manual Setting], input the SSID name of the access point, then select the security system.

3 Input the password, and select [OK].

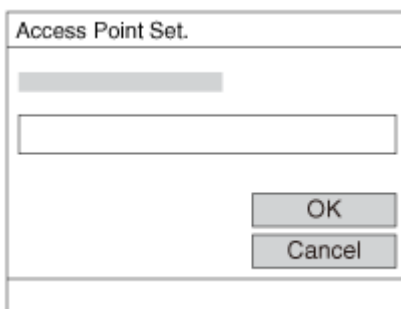

- Access points without the  (lock) mark do not require a password.

4 Select [OK].

Other setting items

Depending on the status or the setting method of your access point, you may want to set more items.

WPS PIN:

Displays the PIN code you enter into the connected device.

Priority Connection:

Select [On] or [Off].

IP Address Setting:

Select [Auto] or [Manual].

IP Address:

If you are entering the IP address manually, enter the set address.

Subnet Mask/Default Gateway:

If you have set [IP Address Setting] to [Manual], enter each address according to your network environment.

Note

- To give the registered access point priority in the future, set [Priority Connection] to [On].

Related Topic

- [Wi-Fi Settings: WPS Push](#)
- [How to use the keyboard](#)

Digital Camera
ZV-1

Wi-Fi Settings: Display Wi-Fi Info.

Displays Wi-Fi information for the camera such as the MAC address, IP address, etc.

1 MENU →  (Network) → [Wi-Fi Settings] → [Display Wi-Fi Info.].

Wi-Fi Settings: SSID/PW Reset

This product shares connection information for [Send to Smartphone] and [Connection] under [Ctrl w/ Smartphone] with devices that have permission to connect. If you want to change the devices that are permitted to connect, reset the connection information.

1 MENU →  (Network) → [Wi-Fi Settings] → [SSID/PW Reset] → [OK].

Note

- If you connect this product to a smartphone after resetting the connection information, you must make the settings for the smartphone again.

Related Topic

- [Send to Smartphone Func.: Send to Smartphone](#)
- [Ctrl w/ Smartphone](#)

Digital Camera
ZV-1

Bluetooth Settings

Controls the settings for connecting the camera to a smartphone or Bluetooth remote commander via a Bluetooth connection.

If you want to pair the camera and smartphone in order to use the location information link function, refer to “Location Info. Link Set..”

If you want to perform pairing in order to use a Bluetooth remote commander, refer to “Bluetooth Rmt Ctrl.”

1 MENU →  (Network) → [Bluetooth Settings] → desired setting.

Menu item details

Bluetooth Function (On/Off):

Sets whether to activate or not the Bluetooth function of the camera.

Pairing:

Displays the screen for pairing the camera and smartphone or Bluetooth remote commander.

Disp Device Address:

Displays the BD address of the camera.

Related Topic

- [Location Info. Link Set.](#)
- [Bluetooth Rmt Ctrl](#)

Digital Camera
ZV-1

Location Info. Link Set.

You can use the application Imaging Edge Mobile to obtain location information from a smartphone that is connected with your camera using Bluetooth communication. You can record the obtained location information when shooting images.

Preparation in advance









To use the location information linking function of the camera, the application Imaging Edge Mobile is required. If “Location Information Linkage” is not displayed on the top page of Imaging Edge Mobile, you need to perform the following steps beforehand.



1. Install Imaging Edge Mobile on your smartphone.
 - You can install Imaging Edge Mobile from the application store of your smartphone. If you have already installed the application, update it to the latest version.
2. Transfer a pre-recorded image to your smartphone using the [Send to Smartphone] function of the camera.
 - After you transfer an image recorded using the camera to your smartphone, “Location Information Linkage” will appear on the top page of the application.

Operating procedure

: Operations performed on the smartphone

: Operations performed on the camera

1. : Confirm that the Bluetooth function of your smartphone is activated.
 - Do not perform the Bluetooth pairing operation on the smartphone setting screen. In steps 2 to 7, the pairing operation is performed using the camera and the application Imaging Edge Mobile.
 - If you accidentally perform the pairing operation on the smartphone setting screen in step 1, cancel the pairing and then perform the pairing operation by following Steps 2 through 7 using the camera and the application Imaging Edge Mobile.
2. : On the camera, select MENU →  (Network) → [Bluetooth Settings] → [Bluetooth Function] → [On].
3. : On the camera, select MENU →  (Network) → [Bluetooth Settings] → [Pairing].
4. : Launch Imaging Edge Mobile on your smartphone and tap “Location Information Linkage.”
 - If “Location Information Linkage” is not displayed, follow the steps in “Preparation in advance” above.
5. : Activate [Location Information Linkage] on the [Location Information Linkage] setting screen of Imaging Edge Mobile.
6. : Follow the instructions on the [Location Information Linkage] setting screen of Imaging Edge Mobile, and then select your camera from the list.
7. : Select [OK] when a message is displayed on the monitor of the camera.
 - Pairing of the camera and Imaging Edge Mobile is complete.

8.  : On the camera, select MENU →  (Network) → [ Location Info. Link Set.] → [Location Info. Link] → [On].

-  (obtaining location information icon) will be displayed on the monitor of the camera. Location information obtained by your smartphone using GPS, etc., will be recorded when shooting images.

Menu item details

Location Info. Link:

Sets whether to obtain the location information by linking with a smartphone.

Auto Time Correct.:

Sets whether to automatically correct the date setting of the camera using information from a linked smartphone.

Auto Area Adjust.:

Sets whether to automatically correct the area setting of the camera using information from a linked smartphone.

Icons displayed when obtaining the location information

 (Obtaining location information): The camera is obtaining the location information.

 (Location information cannot be obtained): The camera cannot obtain the location information.

 (Bluetooth connection available): Bluetooth connection with the smartphone is established.

 (Bluetooth connection unavailable): Bluetooth connection with the smartphone is not established.

Hint

- Location information can be linked when Imaging Edge Mobile is running on your smartphone even if the smartphone monitor is off. However, if the camera has been turned off for a while, location information may not be linked immediately when you turn the camera back on. In this case, location information will be linked immediately if you open the Imaging Edge Mobile screen on the smartphone.
- When Imaging Edge Mobile is not operating, such as when the smartphone is restarted, launch Imaging Edge Mobile to resume location information linking.
- If the location information linking function does not work properly, see the following notes and perform pairing again.
 - Confirm that the Bluetooth function of your smartphone is activated.
 - Delete the pairing information for the camera registered in the smartphone's Bluetooth settings.
 - Confirm that the camera is not connected with other devices using the Bluetooth function.
 - Confirm that [Airplane Mode] for the camera is set to [Off].
 - Delete the pairing information for the camera registered in Imaging Edge Mobile.
 - Execute [Reset Network Set.] of the camera.
- For more detailed instructions, refer to the following support page.
<https://www.sony.net/iem/btg/>

Note

- When you initialize the camera, the pairing information is also deleted. Before performing pairing again, first delete the pairing information for the camera registered in the smartphone's Bluetooth settings and Imaging Edge Mobile.
- The location information will not be recorded when it cannot be obtained, such as when the Bluetooth connection is disconnected.
- The camera can be paired with up to 15 Bluetooth devices, but can link the location information with that of only one smartphone. If you want to link the location information with that of another smartphone, turn off the [Location Information Linkage] function of the smartphone that is already linked.
- If the Bluetooth connection is unstable, remove any obstacles, such as people or metal objects from between the camera and the paired smartphone.
- When pairing the camera and your smartphone, be sure to use the [Location Information Linkage] menu on Imaging Edge Mobile.
- To use the location information linkage function, set [Bluetooth Rmt Ctrl] to [Off].
- The communication distance for Bluetooth or Wi-Fi may vary depending on the conditions of use.

Supported smartphones

Refer to the support page for the latest information.

<https://www.sony.net/iem/>

- For details on Bluetooth versions compatible with your smartphone, check the product website for your smartphone.
-



Related Topic

- [Imaging Edge Mobile](#)
- [Send to Smartphone Func.: Send to Smartphone](#)
- [Bluetooth Settings](#)
- [Bluetooth Rmt Ctrl](#)

5-016-934-11(1) Copyright 2020 Sony Corporation

Bluetooth Rmt Ctrl

You can operate the camera using a Bluetooth remote commander (sold separately). For details on compatible remote commander, visit the Sony web site in your area, or consult your Sony dealer or local authorized Sony service facility. Select MENU →  (Network) → [Bluetooth Settings] → [Bluetooth Function] → [On] in advance. Refer to the instruction manual for the Bluetooth remote commander as well.

- 1 On the camera, select MENU →  (Network) → [Bluetooth Rmt Ctrl] → [On].**
 - If there is no Bluetooth device currently paired with the camera, the screen for pairing as described in Step 2 will appear.
- 2 On the camera, select MENU →  (Network) → [Bluetooth Settings] → [Pairing] to display the screen for pairing.**
- 3 On the Bluetooth remote commander, perform pairing.**
 - For details, refer to the instruction manual for the Bluetooth remote commander.
- 4 On the camera, select [OK] on the confirmation screen for the Bluetooth connection.**
 - Pairing is complete, and you can now operate the camera from the Bluetooth remote commander. After pairing the device once, you can connect the camera and the Bluetooth remote commander again in the future by setting [Bluetooth Rmt Ctrl] to [On].

Menu item details

On:

Enables Bluetooth remote commander operation.

Off:

Disables Bluetooth remote commander operation.

Hint

- The Bluetooth connection is only active while you are operating the camera using the Bluetooth remote commander.
- If the function does not work properly, check the following notes and then try pairing again.
 - Confirm that the camera is not connected with other devices using the Bluetooth function.
 - Confirm that [Airplane Mode] for the camera is set to [Off].
 - Execute [Reset Network Set.] of the camera.

Note

- When you initialize the camera, the pairing information is also deleted. To use the Bluetooth remote commander, perform pairing again.
- If the Bluetooth connection is unstable, remove any obstacles, such as people or metal objects from between the camera and the paired Bluetooth remote commander.
- You cannot use the function for linking location information with a smartphone while [Bluetooth Rmt Ctrl] is set to [On].
- While [Bluetooth Rmt Ctrl] is set to [On], the camera will not switch to the power-saving mode. Change the setting to [Off] when you are done using the Bluetooth remote commander.

Related Topic

- [Bluetooth Settings](#)

5-016-934-11(1) Copyright 2020 Sony Corporation

Digital Camera
ZV-1

Edit Device Name

You can change the device name for Wi-Fi Direct, [PC Remote], or Bluetooth connections.

- 1 MENU** →  **(Network)** → **[Edit Device Name]**.
- 2 Select the input box, then input the device name**→**[OK]**.

Related Topic

- [Wi-Fi Settings: WPS Push](#)
- [Wi-Fi Settings: Access Point Set.](#)
- [Operating the camera from a computer \(PC Remote Function\)](#)
- [How to use the keyboard](#)

Digital Camera
ZV-1

Reset Network Set.

Resets all the network settings to default settings.

1 MENU →  (Network) → [Reset Network Set.] → [Enter].

Protecting images (Protect)

Protects recorded images against accidental erasure. The  (Protect) mark is displayed on protected images.

1 MENU →  (Playback) → [Protect] → desired setting.

Menu item details

Multiple Img.:

Applies the protection of the selected multiple images.

(1) Select the image to be protected, then press the center of the control wheel. A  (check) mark is displayed in the check box. To cancel the selection, press the center again to clear the check box.

(2) To protect other images, repeat step (1).

(3) MENU → [OK].

All in this Folder:

Protects all images in the selected folder.

All with this date:

Protects all images taken on the selected date.

Cancel All in this Folder:

Cancels the protection of all images in the selected folder.

Cancel All with this date:

Cancels the protection of all images taken on the selected date.

All Images in This Group:

Protects all the images in the selected group.

Cancel All in This Group:

Cancels the protection of all the images in the selected group.

Hint

- If you assign [Protect] to the key of your choice using MENU →  (Camera Settings2) → [ Custom Key], you can protect images or cancel protection by simply pressing the key.
- If you select a group in [Multiple Img.], all the images in the group will be protected. To select and protect particular images within the group, execute [Multiple Img.] while displaying the images within the group.

Note

- The menu items that can be selected vary according to the [View Mode] setting and the selected content.

Rotating an image (Rotate)

Rotates a recorded image counter-clockwise.

1 Display the image to be rotated, then select **MENU** →  (Playback) → **[Rotate]**.

2 Press the center of the control wheel.

The image is rotated counter-clockwise. The image rotates as you press the center.
If you rotate the image once, the image remains rotated even after the product is turned off.

Note

- Even if you rotate a movie file, it will be played back horizontally on the monitor of the camera.
- You may not be able to rotate images shot using other products.
- When viewing rotated images on a computer, the images may be displayed in their original orientation depending on the software.

Deleting multiple selected images (Delete)

You can delete multiple selected images. Once you have deleted an image, you cannot restore it. Confirm the image to be deleted beforehand.

- 1 MENU →  (Playback) → [Delete] → desired setting.

Menu item details

Multiple Img.:

Deletes the selected images.

- (1) Select the images to be deleted, then press the center of the control wheel. A  (check) mark is displayed in the check box. To cancel the selection, press the center again to clear the check box.
- (2) To delete other images, repeat step (1).
- (3) MENU → [OK].

All in this Folder:

Deletes all images in the selected folder.

All with this date:

Deletes all images taken on the selected date.

All Other Than This Img.:

Deletes all images in the group except the selection.

All Images in This Group:

Deletes all images in the selected group.

Hint

- Perform [Format] to delete all images, including protected images.
- To display the desired folder or date, select the desired folder or date during playback by performing the following procedure:
 (Image Index) lever → select the bar on the left using the control wheel → select the desired folder or date using the top/bottom sides of the control wheel.
- If you select a group in [Multiple Img.], all the images in the group will be deleted. To select and delete particular images within the group, execute [Multiple Img.] while displaying the images within the group.

Note

- The protected images cannot be deleted.
- The menu items that can be selected vary according to the [View Mode] setting and the selected content.

Related Topic

- [Display as Group](#)
- [Deleting a displayed image](#)
- [Format](#)

Digital Camera
ZV-1

Rating

You can assign ratings to recorded images on a scale of the number of stars (★ - ★★★) to make it easier to find images.

1 MENU →  (Playback) → [Rating].

The image rating selection screen will appear.

2 Press the left/right sides of the control wheel to display an image to which you want to assign a rating, and then press the center.

3 Select the level of ★ (Rating) by pressing the left/right side of the control wheel, and then press the center.

4 Press the MENU button to exit the rating setting screen.

Hint

- You can also assign ratings when playing back images by using the custom key. Assign [Rating] to the desired key using [ Custom Key] beforehand, and then press the custom key while playing back an image to which you want to assign a rating. The level of ★ (Rating) changes each time you press the custom key.

Note

- You can assign ratings to still images only.



Related Topic

- [Assigning frequently used functions to buttons \(Custom Key\)](#)
- [Rating Set\(Custom Key\)](#)

Digital Camera
ZV-1

Rating Set(Custom Key)

Sets the available number of stars (★) when rating images with the key to which you have assigned [Rating] using [ Custom Key].

- 1 MENU →  (Playback) → [Rating Set(Custom Key)].
 - 2 Add a  (check) mark to the level of ★ (rating) that you want to activate.
You can select the checked number when setting [Rating] using the custom key.
-

Related Topic

- [Rating](#)
- [Assigning frequently used functions to buttons \(Custom Key\)](#)

Specifying images to be printed (Specify Printing)

You can specify in advance on the memory card which still images you want to print out later. The **DPOF** (print order) icon will appear on the specified images. DPOF refers to “Digital Print Order Format.” DPOF setting will be retained after the image is printed. We recommend that you cancel this setting after printing.

1 MENU →  (Playback) → [Specify Printing] → desired setting.

Menu item details

Multiple Img.:

Selects images to order printing.

(1) Select an image and press the center of the control wheel. A  (check) mark is displayed in the check box. To cancel the selection, press the center again and clear the check box.

(2) Repeat step (1) to print other images. To select all the images from a certain date or in a certain folder, select the check box for the date or folder.

(3) MENU → [OK].

Cancel All:

Clears all DPOF marks.

Print Setting:

Sets whether to print the date on images registered with DPOF marks.

- The position or size of the date (inside or outside of the image) may differ depending on the printer.

Note

- You cannot add the DPOF mark to the following files:
 - RAW images
- The number of copies cannot be specified.
- Some printers do not support the date print function.

Beauty Effect

Allows you to apply the Beauty Effect to retouch the still image of a person and make it look better, for example, by retouching it for smoother skin, larger eyes, and whiter teeth. You can set the effects from level 1 to level 5. An image on which the Beauty Effect is used is saved as a new file. The original image is retained as it is.

- 1 MENU →  (Playback) → [Beauty Effect].
- 2 Select the face for which you want to use the Beauty Effect.
- 3 Select the desired effect, and adjust the retouching level using the control wheel.

(Skin Toning):

Adjusts the skin color as you like.

1. Select the base skin color using up/down, and then press the center.
2. Adjust the color tone using up/down.

(Skin Smoothing):

Removes age spots and wrinkles from the skin.

Adjust the effect level using up/down.

(Shine Removal):

Reduces the look of oily skin. Adjusts the skin color as you like.

Adjust the effect level using up/down.

(Eye Widening):

Enlarges the eyes of the subject. Adjust the size of the eyes using up/down.

(Teeth Whitening):

Whiten the teeth of the subject. You may not be able to whiten the teeth in some images.

Adjust the whiteness of the teeth using up/down.

To apply two or more effects consecutively using [Beauty Effect], first apply one effect to the image, and then select another effect using left/right.



Note

- You cannot use [Beauty Effect] for the following images:
 - Panoramic images
 - Movies
 - RAW images
- You cannot use the Beauty Effect on an extremely small facial image.
- To use the Beauty Effect on two or more faces, select the same image again after the effect has been applied once, and then use the effect on another face.
- The [Beauty Effect] may not work properly for some images.

Digital Camera
ZV-1

Photo Capture

Captures a chosen scene in a movie to save as a still image. First shoot a movie, then pause the movie during playback to capture decisive moments that tend to be missed when shooting still images, and save them as still images.

- 1 **Display the movie that you want to capture as a still image.**
 - 2 **MENU →  (Playback) → [Photo Capture].**
 - 3 **Play back the movie and pause it.**
 - 4 **Find the desired scene using forward slow playback, reverse slow playback, displays the next frame, and displays the previous frame, and then stop the movie.**
 - 5 **Press  (Photo Capture) to capture the chosen scene.**
The scene is saved as a still image.
-

Related Topic



- [Shooting movies](#)
- [Playing back movies](#)

Enlarging an image being played back (Enlarge Image)

Enlarges the image being played back. Use this function to check the focus of the image, etc.

- 1 Display the image you want to enlarge, and slide the W/T (zoom) lever to the T side.**
 - Slide the W/T (zoom) lever to the W side to adjust the zoom scale.
 - The view will zoom in on the part of the image where the camera focused during shooting. If the focus location information cannot be obtained, the camera will zoom in on the center of the image.
- 2 Select the portion you want to enlarge by pressing the top/bottom/right/left sides of the control wheel.**
- 3 Press the MENU button or the center of the control wheel to exit the playback zoom.**

Hint

- You can also enlarge an image being played back using MENU.
- You can change the initial magnification and initial position of enlarged images by selecting MENU →  (Playback) → [ Enlarge Initial Mag.] or [ Enlarge Initial Position].
- You can also enlarge an image by double-tapping the monitor. In addition, you can drag and move the magnified position on the monitor. Set [Touch Operation] to [On] beforehand.

Note

- You cannot enlarge movies.

Related Topic

- [Touch Operation](#)
- [Enlarge Initial Mag.](#)
- [Enlarge Initial Position](#)

Digital Camera
ZV-1

Enlarge Initial Mag.

Sets the initial magnification scale when playing back enlarged images.

1 MENU →  (Playback) → [ Enlarge Initial Mag.] → desired setting.

Menu item details

Standard. Mag.:

Displays an image with the standard magnification.

Previous Mag.:

Displays an image with the previous magnification. The previous magnification is stored even after exiting the playback zoom mode.

Related Topic

- [Enlarging an image being played back \(Enlarge Image\)](#)
- [Enlarge Initial Position](#)

Enlarge Initial Position

Sets the initial position when enlarging an image in playback.

1 MENU →  (Playback) → [ Enlarge Initial Position] → desired setting.

Menu item details

Focused Position:

Enlarges the image from the point of focus during shooting.

Center:

Enlarges the image from the center of the screen.

Related Topic

- [Enlarging an image being played back \(Enlarge Image\)](#)
- [Enlarge Initial Mag.](#)

Digital Camera
ZV-1

Motion Interval ADJ

You can adjust the interval of the tracking of the subject's motion.

1 MENU →  (Playback) → [Motion Interval ADJ] → desired setting.

Related Topic



- [Motion Shot Video](#)

Digital Camera
ZV-1

Cont. PB for Interval



Continuously plays back images shot using interval shooting.

You can create movies from still images produced by interval shooting using the computer software Imaging Edge (Viewer). You cannot create movies from the still images on the camera.

1 MENU →  (Playback) → [Cont. PB for  Interval].

2 Select the image group that you want to play back, and then press the center of the control wheel.

Hint

- On the playback screen, you can start continuous playback by pressing the down button while displaying an image in the group.
- You can resume play or pause by pressing the down button during playback.
- You can change the playback speed by turning the control wheel during playback. You can also change the playback speed by selecting MENU →  (Playback) → [PB Speed for  Interval].
- You can continuously play back images shot with continuous shooting as well.

Related Topic

- [Interval Shoot Func.](#)
- [PB Speed for Interval](#)
- [Introduction to computer software \(PlayMemories Home/Imaging Edge\)](#)

Digital Camera
ZV-1

PB Speed for Interval

Sets the playback speed for still images during [Cont. PB for  Interval].

1 MENU →  (Playback) → [PB Speed for  Interval] → **desired setting.**

Hint

- You can also change the playback speed by turning the control wheel during [Cont. PB for  Interval].

Related Topic

- [Cont. PB for Interval](#)

Playing back images using slideshow (Slide Show)

Automatically plays back images continuously.

1 MENU →  (Playback) → [Slide Show] → desired setting.

2 Select [Enter].

Menu item details

Repeat:

Select [On], in which images are played back in a continuous loop, or [Off], in which the product exits the slideshow when all the images are played back once.

Interval:

Select the display interval for images from among [1 Sec], [3 Sec], [5 Sec], [10 Sec] or [30 Sec].

To quit the slideshow in the middle of playback

Press the MENU button to quit the slideshow. You cannot pause the slideshow.

Hint

- During playback, you can display the next/previous image by pressing the right/left side of the control wheel.
- You can activate a slideshow only when [View Mode] is set to [Date View] or [Folder View(Still)].

Switching between still images and movies (View Mode)

Sets the View Mode (image display method).

1 MENU →  (Playback) → [View Mode] → desired setting.

Menu item details

Date View:

Displays the images by date.

Folder View(Still):

Displays only still images.

AVCHD View:

Displays only AVCHD-format movies.

XAVC S HD View:

Displays only XAVC S HD-format movies.

XAVC S 4K View:

Displays only XAVC S 4K-format movies.

Playing back images on the image index screen (Image Index)

You can display multiple images at the same time in playback mode.

- 1 Slide the W/T (zoom) lever to the W side while the image is being played back.
- 2 Select the image by pressing the top/bottom/right/left sides of the control wheel or turning the control wheel.

To change the number of images to be displayed

MENU →  (Playback) → [Image Index] → desired setting.

Menu item details

9 Images/25 Images

To return to single-image playback

Select the desired image and press the center of the control wheel.

To display a desired image quickly

Select the bar on the left of the image index screen using the control wheel, then press the top/bottom sides of the control wheel. While the bar is being selected, you can display the calendar screen or folder selection screen by pressing the center. In addition, you can switch View Mode by selecting an icon.

Related Topic

- [Switching between still images and movies \(View Mode\)](#)

Display as Group

Sets whether or not to display continuously shot images or images shot using interval shooting as a group.

- 1 MENU →  (Playback) → [Display as Group] → desired setting.

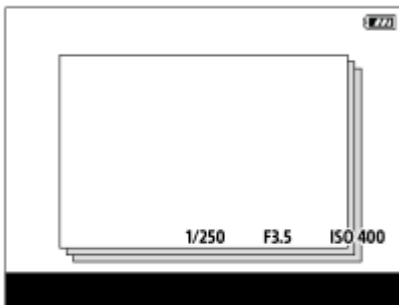

Menu item details

On:



Displays images as a group.

Select a group and press the center of the control wheel to play back images in the group.

Off:

Does not display images as a group.

Hint

- The following images are grouped.
 - Images shot with [Drive Mode] set to [Cont. Shooting] (One sequence of images shot continuously by holding down the shutter button during continuous shooting becomes one group.)
 - Images shot with [ Interval Shoot Func.] (Images shot during one session of interval shooting become one group.)
- On the image index screen, the  (Display as Group) icon is displayed over the group.

Note

- Images can be grouped and displayed only when [View Mode] is set to [Date View]. When it is not set to [Date View], images cannot be grouped and displayed, even if [Display as Group] is set to [On].
- If you delete the group, all the images in the group will be deleted.

Related Topic

- [Cont. Shooting](#)
- [Interval Shoot Func.](#)

Rotating recorded images automatically (Display Rotation)

Selects the orientation when playing back recorded images.

1 MENU →  (Playback) → [Display Rotation] → desired setting.

Menu item details

Auto:

When you rotate the camera, the displayed image rotates automatically by detecting the orientation of the camera.

Manual:

Images shot vertically are displayed vertically. If you have set the image orientation using the [Rotate] function, the image will be displayed accordingly.

Off:

Images are always displayed horizontally.

Note

- Movies shot vertically are played back horizontally on the screen or the finder of the camera during movie playback.

Related Topic

- [Rotating an image \(Rotate\)](#)

Monitor Brightness

Adjust the brightness of the screen.

- 1 **MENU** →  (Setup) → **[Monitor Brightness]** → **desired setting.**

Menu item details



Manual:

Adjusts the brightness within the range of -2 to +2.

Sunny Weather:

Sets the brightness appropriately for shooting outdoors.

Note

- The [Sunny Weather] setting is too bright for shooting indoors. Set [Monitor Brightness] to [Manual] for indoor shooting.
- The monitor brightness cannot be adjusted in the following situations. The maximum brightness will be [±0].
 - When [ File Format] is set to [XAVC S 4K].
 - When [ File Format] is set to [XAVC S HD] and [ Record Setting] is set to [120p]/[100p].
- The monitor brightness is locked at [-2] when shooting a movie using the Wi-Fi functions.
- The monitor brightness is locked at [-2] when an overheating warning is displayed.

Gamma Disp. Assist

Movies with S-Log gamma are assumed to be processed after shooting in order to make use of the wide dynamic range. Movies with the HLG gamma are assumed to be displayed on HDR-compatible monitors. They are therefore displayed in low contrast during shooting, and may be difficult to monitor. However, you can use the [Gamma Disp. Assist] function to reproduce contrast equivalent to that of normal gamma. In addition, [Gamma Disp. Assist] can also be applied when playing back movies on the camera's monitor.

- 1 **MENU** →  (Setup) → [Gamma Disp. Assist].
- 2 **Select the desired setting using the top/bottom sides of the control wheel.**

Menu item details

Assist
OFF **Off:**

Does not apply [Gamma Disp. Assist].

Assist
AUTO **Auto:**

Displays movies with an [S-Log2→709(800%)] effect when the gamma set in [Picture Profile] is [S-Log2], and with an [S-Log3→709(800%)] effect when the gamma is set to [S-Log3]. Displays movies with an [HLG(BT.2020)] effect when the gamma set in [Picture Profile] is [HLG], [HLG1], [HLG2] or [HLG3], and [Color Mode] is set to [BT.2020].

Displays movies with an [HLG(709)] effect when the gamma set in [Picture Profile] is [HLG], [HLG1], [HLG2] or [HLG3], and [Color Mode] is set to [709].

Assist
S-Log2 **S-Log2→709(800%):**

Displays movies with an S-Log2 gamma reproducing contrast equivalent to ITU709 (800%).

Assist
S-Log3 **S-Log3→709(800%):**

Displays movies with an S-Log3 gamma reproducing contrast equivalent to ITU709 (800%).

Assist
HLG 2020 **HLG(BT.2020):**

Displays movies after adjusting the image quality of the monitor to a quality that is almost the same as when movies are displayed on an [HLG(BT.2020)] compatible monitor.

Assist
HLG 709 **HLG(709):**

Displays movies after adjusting the image quality of the monitor to a quality that is almost the same as when movies are displayed on an [HLG(709)] compatible monitor.

Note

- Movies in the XAVC S 4K or XAVC S HD format with the [HLG], [HLG1], [HLG2], or [HLG3] gamma are displayed with an [HLG(BT.2020)] effect or [HLG(709)] effect depending on the movie's gamma value and color mode. In other situations, movies are displayed according to the gamma setting and color mode setting in [Picture Profile].
- [Gamma Disp. Assist] is not applied to movies when displayed on a TV or monitor connected to the camera.

Related Topic

- [Picture Profile](#)

Digital Camera
ZV-1

Volume Settings

Sets the sound volume for movie playback.

1 MENU →  (Setup) → [Volume Settings] → desired setting.

Adjusting the volume during playback

Press the bottom side of the control wheel while playing back movies to display the operation panel, then adjust the volume. You can adjust the volume while listening to the actual sound.

Digital Camera
ZV-1

Tile Menu

Selects whether to always display the first screen of the menu when you press the MENU button.

1 MENU →  (Setup) → [Tile Menu] → desired setting.

Menu item details

On:

Always displays the first screen of the menu (Tile Menu).

Off:

Deactivates the Tile Menu display.

Digital Camera
ZV-1

Delete confirm.

You can set whether [Delete] or [Cancel] is selected as a default on the delete confirmation screen.

1 MENU →  (Setup) → [Delete confirm.] → desired setting.

Menu item details

"Delete" first:

[Delete] is selected as the default setting.

"Cancel" first:

[Cancel] is selected as the default setting.

Digital Camera
ZV-1

Auto Monitor OFF

The camera automatically switches to the power-saving mode if you do not operate the camera for a certain period of time in the still-image shooting mode. This function is useful for reducing the power consumption.

1 MENU →  (Setup) → [Auto Monitor OFF] → desired setting

Menu item details

Does not turn OFF:

The camera does not switch to the power-saving mode automatically.

2 Sec/5 Sec/10 Sec:

The camera switches to the power-saving mode and the monitor turns off if a certain number of seconds elapses without any operations.

When [5 Sec] or [10 Sec] is selected, the monitor darkens two seconds before the end of the duration you have set.

Note

- [Auto Monitor OFF] does not activate in the following situations:
 - When the monitor is facing forward
 - When the shooting mode is set to [Sweep Panorama]
 - In cases which the power-saving function will not activate (As an exception, [Auto Monitor OFF] will activate when [Bluetooth Rmt Ctrl] is set to [On].)

Digital Camera
ZV-1

Power Save Start Time

You can set the time by which the power goes off automatically.

1 MENU →  (Setup) → [Power Save Start Time] → desired setting.

Menu item details

30 Min/5 Min/2 Min/1 Min

Note

- The power save function is deactivated in the following situations:
 - While power is being supplied via USB
 - While playing back slideshows
 - While recording movies
 - While connected to a computer or TV
 - When [Bluetooth Rmt Ctrl] is set to [On]

Power OFF w/ monitor

Sets whether or not the power turns off when the monitor is closed facing inward.

1 MENU →  (Setup) → [Power OFF w/ monitor] → **desired setting.**

Menu item details

Power OFF:

The power turns off when the monitor is closed facing inward.

Not Power OFF:

The power does not turn off when the monitor is closed facing inward.

Hint

- When you want to keep shooting images with the monitor closed facing inward, such as during interval shooting or movie recording, set [Power OFF w/ monitor] to [Not Power OFF].

Digital Camera
ZV-1

Auto Power OFF Temp.

Sets the temperature of the camera at which the camera turns off automatically during shooting. When it is set to [High], you can continue shooting even when the temperature of the camera gets hotter than normal.

1 MENU →  (Setup) → [Auto Power OFF Temp.] → desired setting.

Menu item details

Standard:

Sets the standard temperature for the camera to turn off.

High:

Sets the temperature at which the camera turns off to higher than [Standard].

Notes when [Auto Power OFF Temp.] is set to [High]

- Do not shoot while holding the camera in your hand. Use a tripod.
- Using the camera while holding it in your hand for a long period of time may cause low-temperature burns.

Continuous recording time for movies when [Auto Power OFF Temp.] is set to [High]

The duration of time available for continuous movie recording is as follows when the camera starts recording with the default settings after the power has been turned off for a while. The following values indicate the continuous time from when the camera starts recording until the camera stops recording.

Ambient temperature: 20°C (68°F)

Continuous recording time for movies (HD): Approx. 30 minutes

Continuous recording time for movies (4K): Approx. 30 minutes

Ambient temperature: 30°C (86°F)

Continuous recording time for movies (HD): Approx. 30 minutes

Continuous recording time for movies (4K): Approx. 30 minutes

Ambient temperature: 40°C (104°F)

Continuous recording time for movies (HD): Approx. 20 minutes

Continuous recording time for movies (4K): Approx. 20 minutes

HD: XAVC S HD (60p 50M/50p 50M, when the camera is not connected via Wi-Fi)

4K: XAVC S 4K (24p 60M/25p 60M, when the camera is not connected via Wi-Fi)

Note

- Even if [Auto Power OFF Temp.] is set to [High], depending on the conditions or the temperature of the camera, the recordable time for movies may not change.

Related Topic

- [Recordable movie times](#)

NTSC/PAL Selector

Plays back movies recorded with the product on a NTSC/PAL system TV.

1 MENU →  (Setup) → [NTSC/PAL Selector] → [Enter]

Note

- If you insert a memory card that has previously been formatted with a different video system, a message telling you that you must reformat the card will appear.
If you want to record using another system, re-format the memory card or use another memory card.
- When you perform [NTSC/PAL Selector], and the setting is changed from the default one, a message "Running on NTSC." or "Running on PAL." will appear on the start-up screen.

Digital Camera
ZV-1

Touch Operation

Sets whether or not to activate touch operations on the monitor.

1 MENU →  (Setup) → [Touch Operation] → desired setting.

Menu item details

On:

Activates the touch operation.

Off:

Deactivates the touch operation.

Related Topic

- [Func. of Touch Operation: Touch Shutter](#)
- [Func. of Touch Operation: Touch Focus](#)
- [Func. of Touch Operation: Touch Tracking](#)

Digital Camera
ZV-1

Demo Mode

The [Demo Mode] function displays the movies recorded on the memory card automatically (demonstration), when the camera has not been operated for a certain time. Normally select [Off].

1 MENU →  (Setup) → [Demo Mode] → desired setting.

Menu item details

On:

The movie playback demonstration starts automatically if the product is not operated for about one minute. Only protected AVCHD movies can be played back.

Set the view mode to [AVCHD View], and protect the movie file with the oldest recorded date and time.

Off:

Does not show the demonstration.

Note

- When there is no protected AVCHD movies on the memory card, you cannot select [On].

Digital Camera
ZV-1

TC/UB Settings

The time code (TC) and the user bit (UB) information can be recorded as data attached to movies.

- 1 MENU →  (Setup) → [TC/UB Settings] → setting value you want to change.

Menu item details

TC/UB Disp. Setting:

Sets the display for the counter, time code, and user bit.

TC Preset:

Sets the time code.

UB Preset:

Sets the user bit.

TC Format:

Sets the recording method for the time code. (Only when [NTSC/PAL Selector] is set to NTSC.)

TC Run:

Sets the count up format for the time code.

TC Make:

Sets the recording format for the time code on the recording medium.

UB Time Rec:

Sets whether or not to record the time as a user bit.



How to set the time code (TC Preset)

1. MENU →  (Setup) → [TC/UB Settings] → [TC Preset].
2. Press the top/bottom side of the control wheel, and select the first two digits.
 - The time code can be set between the following range.
When [60i] is selected: 00:00:00:00 to 23:59:59:29
 - * When [24p] is selected, you can select the last two digits of the time code in multiples of four from 0 to 23 frames.
When [50i] is selected: 00:00:00:00 to 23:59:59:24
3. Set the other digits following the same procedure as in step 2, then press in the center of the control wheel.

Note

- When you rotate the monitor to shoot a self-portrait, the time code and user bit will not be displayed.



How to reset the time code

1. MENU →  (Setup) → [TC/UB Settings] → [TC Preset].
 2. Press the  (Delete) button to reset the time code (00:00:00:00).
- You can also reset the time code (00:00:00:00) using the RMT-VP1K remote commander (sold separately).

How to set the user bit (UB Preset)

1. MENU →  (Setup) → [TC/UB Settings] → [UB Preset].
2. Press the top/bottom side of the control wheel, and select the first two digits.
3. Set the other digits following the same procedure as in step 2, then press in the center of the control wheel.

How to reset the user bit

1. MENU →  (Setup) → [TC/UB Settings] → [UB Preset].
2. Press the  (Delete) button to reset the user bit (00 00 00 00).

How to select the recording method for the time code (TC Format ^{*1})

1. MENU →  (Setup) → [TC/UB Settings] → [TC Format].

DF:

Records the time code in Drop Frame^{*2} format.

NDF:

Records the time code in Non-Drop Frame format.

*1 Only when [NTSC/PAL Selector] is set to NTSC.

*2 The time code is based on 30 frames per second. However, a gap between the actual time and the time code will occur during extended periods of recording as the frame frequency of the NTSC image signal is approximately 29.97 frames per second. Drop frame corrects this gap to make the time code and actual time equal. In drop frame, the first 2 frame numbers are removed every minute except for every tenth minute. The time code without this correction is called non-drop frame.

- The setting is fixed to [NDF] when recording in 4K/24p or 1080/24p.

How to select the count up format for the time code (TC Run)

1. MENU →  (Setup) → [TC/UB Settings] → [TC Run].

Rec Run:

Sets the stepping mode for the time code to advance only while recording. The time code is recorded sequentially from the last time code of the previous recording.

Free Run:

Sets the stepping mode for the time code to advance anytime, regardless of the camera operation.

- The time code may not be recorded sequentially in the following situations even when the time code advances in [Rec Run] mode.
 - When the recording format is changed.
 - When the recording medium is removed.

How to select how the time code is recorded (TC Make)

1. MENU →  (Setup) → [TC/UB Settings] → [TC Make].

Preset:

Records the newly set time code on the recording medium.

Regenerate:

Reads the last time code for the previous recording from the recording medium and records the new time code consecutively from the last time code. The time code advances in [Rec Run] mode regardless of the [TC Run] setting.

Digital Camera
ZV-1

HDMI Settings: HDMI Resolution

When you connect the product to a High Definition (HD) TV with HDMI terminals using an HDMI cable (sold separately), you can select HDMI Resolution to output images to the TV.

1 MENU →  (Setup) → [HDMI Settings] → [HDMI Resolution] → **desired setting.**

Menu item details

Auto:

The product automatically recognizes an HD TV and sets the output resolution.

2160p/1080p:

Outputs signals in 2160p/1080p.

1080p:

Outputs signals in HD picture quality (1080p).

1080i:

Outputs signals in HD picture quality (1080i).



Note

- If the images are not displayed properly using the [Auto] setting, select either [1080i], [1080p] or [2160p/1080p], based on which TV is to be connected.

Digital Camera
ZV-1

HDMI Settings: 24p/60p Output (movie) (Only for 1080 60i compatible models)

You can set 1080/24p or 1080/60p as the HDMI output format when [ Record Setting] is set to [24p 50M], [24p 60M] or [24p 100M].

- 1 MENU →  (Setup) → [HDMI Settings] → [HDMI Resolution] → [1080p] or [2160p/1080p].
- 2 MENU →  (Setup) → [HDMI Settings] → [ 24p/60p Output] → desired setting.

Menu item details

60p:

Movies are output as 60p.

24p:

Movies are output as 24p.

Note

- Steps 1 and 2 can be set in either order.

Related Topic

- [Record Setting \(movie\)](#)

Digital Camera
ZV-1

HDMI Settings: HDMI Info. Display

Selects whether to display the shooting information when this product and the TV are connected using an HDMI cable (sold separately).

1 MENU →  (Setup) → [HDMI Settings] → [HDMI Info. Display] → desired setting.

Menu item details

On:

Displays the shooting information on the TV.

The recorded image and the shooting information are displayed on the TV, while nothing is displayed on the camera's monitor.

Off:

Does not display the shooting information on the TV.

Only the recorded image is displayed on the TV, while the recorded image and the shooting information are displayed on the camera's monitor.

Note

- When the camera is connected to an HDMI device while [ File Format] is set to [XAVC S 4K], the setting switches to [Off].

Digital Camera
ZV-1

HDMI Settings: TC Output (movie)

Sets whether or not to layer the TC (time code) information on the output signal via the HDMI terminal when outputting the signal to other professional-use devices.

This function layers the time code information on the HDMI output signal. The product sends the time code information as digital data, not as an image displayed on the screen. The connected device can then refer to the digital data to recognize the time data.

1 MENU →  (Setup) → [HDMI Settings] → [ TC Output] → desired setting.

Menu item details



On:

Time code is output to other devices.

Off:

Time code is not output to other devices.

Note

- When [ TC Output] is set to [On], the image may not be output properly to the TV or recording device. In such cases, set [ TC Output] to [Off].

Digital Camera
ZV-1

HDMI Settings: REC Control (movie)

If you connect the camera to an external recorder/player, you can remotely command the recorder/player to start/stop recording using the camera.

1 MENU →  (Setup) → [HDMI Settings] → [ REC Control] → desired setting.

Menu item details

On:









 STBY (STBY) The camera can send a recording command to an external recorder/player.

 REC (REC) The camera is sending a recording command to an external recorder/player.

Off:

The camera is not able to send a command to an external recorder/player to start/stop recording.

Note

- Available for external recorders/players compatible with [ REC Control].
- When you use the [ REC Control] function, set the shooting mode to  (Movie) or  ( Intelligent Auto).
- When [ TC Output] is set to [Off], you cannot use the [ REC Control] function.
- Even when  REC (REC) is displayed, the external recorder/player may not work properly depending on the settings or status of the recorder/player. Check if the external recorder/player works properly before use.

Digital Camera
ZV-1

HDMI Settings: CTRL FOR HDMI

When connecting this product to a “BRAVIA” Sync-compatible TV using an HDMI cable (sold separately), you can operate this product by aiming the TV remote control at the TV.

1 MENU →  (Setup) → [HDMI Settings] → [CTRL FOR HDMI] → desired setting.

2 Connect this product to a “BRAVIA” Sync-compatible TV.

The input of the TV is switched automatically and images on this product are displayed on the TV screen.

3 Press the SYNC MENU button of the TV’s remote control.

4 Operate this product using the TV’s remote control.

Menu item details

On:

You can operate this product with a TV’s remote control.

Off:

You cannot operate this product with a TV’s remote control.



Note

- If you connect this product to a TV using an HDMI cable, available menu items are limited.
- [CTRL FOR HDMI] is available only with a “BRAVIA” Sync-compatible TV. Also, the SYNC MENU operation differs depending on the TV you are using. For details, refer to the operating instructions supplied with the TV.
- If the product performs unwanted operations in response to the TV remote control when the product is connected to another manufacturer’s TV using an HDMI connection, select MENU →  (Setup) → [HDMI Settings] → [CTRL FOR HDMI] → [Off].

Digital Camera
ZV-1

4K Output Select (movie)

You can set how to record movies and perform HDMI output when your camera is connected to 4K-compatible external recording/playback devices, etc.

- 1 Set the shooting mode to [Movie] or [ Intelligent Auto].
- 2 Connect the camera to the desired device via an HDMI cable.
- 3 MENU →  (Setup) → [ 4K Output Select] → desired setting.

Menu item details

Memory Card+HDMI:

Simultaneously outputs to the external recording/playback device and records on the camera's memory card.

HDMI Only(30p):

Outputs a 4K movie in 30p to the external recording/playback device without recording on the camera's memory card.

HDMI Only(24p):



Outputs a 4K movie in 24p to the external recording/playback device without recording on the camera's memory card.

HDMI Only(25p) *:

Outputs a 4K movie in 25p to the external recording/playback device without recording on the camera's memory card.

* Only when [NTSC/PAL Selector] is set to PAL.

Note

- This item can be set only when the camera is in movie mode and connected to a 4K-compatible device.
- When [HDMI Only(30p)], [HDMI Only(24p)] or [HDMI Only(25p)] is set, [HDMI Info. Display] will temporarily be set to [Off].
- When [HDMI Only(30p)], [HDMI Only(24p)] or [HDMI Only(25p)] is set, the counter does not move forward (the actual recording time is not counted) while the movie is being recorded on an external recording/playback device.
- When shooting 4K movies using the setting [Memory Card+HDMI], the movies will not be output to a device connected by HDMI cable if you simultaneously record a proxy movie. If you want to perform HDMI output, set [ Proxy Recording] to [Off]. (In this case, if you set [ Record Setting] to other values except [24p], the image will not be displayed on the screen of the camera).
- When [ File Format] is set to [XAVC S 4K] and the camera is connected via HDMI, the following functions are partially restricted.
 - [Face/Eye Priority in AF]
 - [Face Priority in Multi Metering]
 - Tracking function

Related Topic

- [HDMI Settings: REC Control \(movie\)](#)
- [File Format \(movie\)](#)
- [Record Setting \(movie\)](#)
- [HDMI Settings: HDMI Info. Display](#)

Digital Camera
ZV-1

USB Connection

Selects the USB connection method when this product is connected to a computer, etc.

Select MENU →  (Network) → [Ctrl w/ Smartphone] → [Ctrl w/ Smartphone] → [Off] beforehand.

Also, when you set MENU →  (Network) → [PC Remote Function] → [PC Remote Cnct Method] to [USB], set [PC Remote] under [PC Remote Function] to [Off].

1 MENU →  (Setup) → [USB Connection] → desired setting.

Menu item details

Auto:

Establishes a Mass Storage or MTP connection automatically, depending on the computer or other USB devices to be connected. Windows 8.1 or Windows 10 computers are connected in MTP, and their unique functions are enabled for use.

Mass Storage:

Establishes a Mass Storage connection between this product, a computer, and other USB devices.

MTP:

Establishes an MTP connection between this product, a computer, and other USB devices. Windows 8.1 or Windows 10 computers are connected in MTP, and their unique functions are enabled for use.

Note

- It may take some time to make the connection between this product and a computer when [USB Connection] is set to [Auto].

Digital Camera
ZV-1

USB LUN Setting

Enhances compatibility by limiting of USB connection functions.

1 MENU →  (Setup) → [USB LUN Setting] → desired setting.

Menu item details

Multi:

Normally, use [Multi].

Single:

Set [USB LUN Setting] to [Single] only if you cannot make a connection.

Digital Camera
ZV-1

USB Power Supply

Sets whether to supply power via the micro USB cable when the product is connected to a computer or an USB device.

1 MENU →  (Setup) → [USB Power Supply] → desired setting.

Menu item details

On:

Power is supplied to the product via a micro USB cable when the product is connected to a computer, etc.

Off:

Power is not supplied to the product via a micro USB cable when the product is connected to a computer, etc.

Operations available while supplying power via a USB cable

The following table shows you which operations are available/unavailable while supplying power via a USB cable.

Operation	Available / Unavailable
Shooting images	Available
Playing back images	Available
Wi-Fi/Bluetooth connections	Available
Charging a battery pack	Unavailable
Turning the camera on without a battery pack inserted	Unavailable

Note

- Insert the battery pack into the product to supply power via USB cable.

Digital Camera
ZV-1

Language

Selects the language to be used in the menu items, warnings and messages.

1 MENU →  (Setup) → [ Language] → **desired language**.

Digital Camera
ZV-1

Date/Time Setup

The Clock Set screen is displayed automatically when you turn on this product for the first time or when the internal rechargeable backup battery has fully discharged. Select this menu when setting the date and time after the first time.

1 MENU →  (Setup) → [Date/Time Setup] → desired setting.

Menu item details

Daylight Savings:

Selects Daylight Savings [On]/[Off].

Date/Time:

Sets the date and time.

Date Format:

Selects the date and time display format.

Hint

- To charge the internal rechargeable backup battery, insert a charged battery pack, and leave the product for 24 hours or more with the power off.
- If the clock resets every time the battery is charged, the internal rechargeable backup battery may be worn out. Consult your service facility.

Digital Camera
ZV-1

Area Setting

Sets the area where you are using the product.

1 MENU →  (Setup) → [Area Setting] → desired area.

Format

When you use a memory card with this camera for the first time, we recommend that you format the card using the camera for stable performance of the memory card. Note that formatting permanently erases all data on the memory card, and is unrecoverable. Save valuable data on a computer, etc.

1 MENU →  (Setup) → [Format].

Note

- Formatting permanently erases all data including protected images and registered settings (from M1 to M4).
- The access lamp lights up during formatting. Do not remove the memory card while the access lamp is lit up.
- Format the memory card on this camera. If you format the memory card on the computer, the memory card may not be usable depending on the format type.
- It may take a few minutes to complete formatting, depending on the memory card.
- You cannot format the memory card if the remaining battery charge is less than 1%.

Digital Camera
ZV-1

Select REC Folder

If [Folder Name] under [ File/Folder Settings] is set to [Standard Form] and there are 2 folders or more, you can select the folder on the memory card to which images are to be recorded.

1 MENU →  (Setup) → [Select REC Folder] → desired folder.

Note

- You cannot select the folder when [Folder Name] under [ File/Folder Settings] is set to [Date Form].

Related Topic

- [File/Folder Settings \(still image\)](#)

Digital Camera
ZV-1

New Folder

Creates a new folder on the memory card for recording still images. A new folder is created with a folder number one greater than the largest folder number currently used. Images are recorded in the newly created folder.

1 MENU →  (Setup) → [New Folder].

Note

- When you insert a memory card that was used with other equipment into this product and shoot images, a new folder may be automatically created.
- Up to 4,000 images in total can be stored in one folder. When the folder capacity is exceeded, a new folder may be automatically created.

Digital Camera
ZV-1

File/Folder Settings (still image)

Sets file names for still images to be shot, and specifies folders for storing the shot still images.

1 MENU →  (Setup) → [ File/Folder Settings] → desired setting.

Menu item details

File Number:

You can set how to assign file numbers to still images.

[Series]: Does not reset file numbers for each folder.

[Reset]: Resets file numbers for each folder.

Set File Name:

You can specify the first three characters of the file name.

Folder Name:

You can set how folder names are assigned.

[Standard Form]: Folders are named as “folder number + MSDCF”.

Example: 100MSDCF

[Date Form]: Folders are named as “folder number + Y (the last digit of the year)/MM/DD”.

Example: 10000405 (Folder number: 100; date: 04/05/2020)



Note

- Only capital letters, numbers, and underscores can be used for [Set File Name]. Underscores cannot be used for the first character.
- The three characters specified using [Set File Name] are only applied to files recorded after the setting is made.

Digital Camera
ZV-1

File Settings (movie)

Configure settings for the file names of recorded movies.

1 MENU →  (Setup) → [ File Settings] → desired setting.

Menu item details

File Number:

You can set how to assign file numbers to movies.

[Series]: Does not reset file numbers even if the memory card is changed.

[Reset]: Resets the file number when the memory card is changed.

Series Counter Reset:

Resets the series counter used when [File Number] is set to [Series].

File Name Format:

You can set the format for movie file names.

[Standard]: The file name of the recorded movie starts with "C." Example: C0001

[Title]: The file name of the recorded movie becomes "Title+File number."

[Date + Title]: The file name of the recorded movie becomes "Date+Title+File number."

[Title + Date]: The file name of the recorded movie becomes "Title+Date+ File number."

Title Name Settings:

You can set the title when [File Name Format] is set to [Title], [Date + Title], or [Title + Date].

Note

- Only alphanumeric characters and symbols can be input for [Title Name Settings]. Up to 37 characters can be entered.
- Titles specified using [Title Name Settings] are only applied to movies recorded after the setting is made.
- [ File Settings] does not apply to AVCHD movies.
- You cannot set how folder names are assigned for movies.
- If you are using an SDHC memory card, [File Name Format] is locked to [Standard].
- If there are unused numbers due to file deletion, etc., these numbers will be reused when the movie file number reaches "9999."

Digital Camera
ZV-1

Recover Image DB

If image files were processed on a computer, problems may occur in the image database file. In such cases, the images on the memory card will not be played back on this product. If these problems happen, repair the file using [Recover Image DB].

1 MENU →  (Setup) → [Recover Image DB] → [Enter].

Note

- If the battery pack is extremely depleted, image database files cannot be repaired. Use a sufficiently charged battery pack.
- Images recorded on the memory card are not deleted by [Recover Image DB].

Digital Camera
ZV-1

Display Media Info.

Displays the recordable time of movies for the inserted memory card. Also displays the number of recordable still images for the inserted memory card.

① MENU →  (Setup) → [Display Media Info.].

Digital Camera
ZV-1

Version

Displays the version of this product's software. Check the version when updates for this product's software are released, etc.

1 MENU →  (Setup) → [Version].

Note

- Updating can be performed only when the battery level is  (3 remaining battery bars) or more. Use a sufficiently charged battery pack.

Digital Camera
ZV-1

Setting Reset

Resets the product to the default settings. Even if you perform [Setting Reset], the recorded images are retained.

1 MENU →  (Setup) → [Setting Reset] → desired setting.

Menu item details

Camera Settings Reset:

Initializes the main shooting settings to the default settings.

Initialize:

Initializes all the settings to the default settings.

Note

- Be sure not to eject the battery pack while resetting.
- Settings of [Picture Profile] will not be reset even when [Camera Settings Reset] or [Initialize] is performed.

Digital Camera
ZV-1

Add Item

You can register the desired menu items to ★ (My Menu) under MENU.

- 1 MENU → ★ (My Menu) → [Add Item].
- 2 Select an item that you want to add to ★ (My Menu) using the top/bottom/left/right sides of the control wheel.
- 3 Select a destination using the top/bottom/left/right sides of the control wheel.

Hint

- You can add up to 30 items to ★ (My Menu).

Note

- You cannot add the following items to ★ (My Menu).
 - Any item under MENU →  (Playback)
 - [View on TV]

Related Topic

- [Sort Item](#)
- [Delete Item](#)
- [Using MENU items](#)

Digital Camera
ZV-1

Sort Item

You can rearrange the menu items added to ★ (My Menu) under MENU.

- 1 MENU → ★ (My Menu) → [Sort Item].
 - 2 Select an item that you want to move using the top/bottom/left/right sides of the control wheel.
 - 3 Select a destination using the top/bottom/left/right sides of the control wheel.
-
-

Related Topic

- [Add Item](#)

Delete Item

You can delete menu items added to ★ (My Menu) of MENU.

- 1 MENU → ★ (My Menu) → [Delete Item].
- 2 Select an item that you want to delete using the top/bottom/left/right sides of the control wheel, and then press the center to delete the selected item.

Hint

- To delete all the items on a page, select MENU → ★ (My Menu) → [Delete Page].
- You can delete all the items added to ★ (My Menu) by selecting MENU → ★ (My Menu) → [Delete All].

Related Topic

- [Delete Page](#)
- [Delete All](#)
- [Add Item](#)

Digital Camera
ZV-1

Delete Page

You can delete all the menu items added to a page under ★ (My Menu) in MENU.

- 1 MENU → ★ (My Menu) → [Delete Page].
 - 2 Select a page that you want to delete using the left/right sides of the control wheel, and then press the center of the control wheel to delete the items.
-

Related Topic

- [Add Item](#)
- [Delete All](#)

Digital Camera
ZV-1

Delete All

You can delete all the menu items added to ★ (My Menu) in MENU.

1 MENU → ★ (My Menu) → [Delete All].

2 Select [OK].

Related Topic

- [Add Item](#)
- [Delete Page](#)

Digital Camera
ZV-1

Display From My Menu

You can set My Menu to appear first when you press the MENU button.

1 MENU → ★ (My Menu) → [Display From My Menu] → desired setting.

Menu item details

On:

My Menu appears first when you press the MENU button.

Off:

The most recently displayed menu appears when you press the MENU button.

Related Topic

- [Add Item](#)

Precautions

Refer also to “Notes on use” in the Startup Guide (supplied) for this product.

On the data specifications described in this manual

- The data on performance and specifications in this manual are based on an ordinary ambient temperature of 25°C (77°F), except where otherwise indicated.
- For the battery pack, the data are based on a battery pack that was fully charged until the charge lamp turned off.

On operating temperatures

- Shooting in extremely cold or hot environments that exceed the operating temperature range is not recommended.
- Under high ambient temperatures, the temperature of the camera rises quickly.
- When the temperature of the camera rises, the image quality may deteriorate. It is recommended that you wait until the temperature of the camera drops before continuing to shoot.
- Depending on the camera and battery temperature, the camera may become unable to record movies or the power may turn off automatically to protect the camera. A message will be displayed on the screen before the power turns off or you can no longer record movies. In this case, leave the power off and wait until the camera and battery temperature goes down. If you turn on the power without letting the camera and battery cool sufficiently, the power may turn off again, or you may still be unable to record movies.

Notes on recording for long periods of time or recording 4K movies

Especially during 4K movie shooting, the recording time may be shorter under low temperature conditions. Warm up the battery pack or replace it with a new battery.

Notes on playing movies on other devices

XAVC S movies can be played back only on XAVC S-supported devices.

Notes on recording/playback

- Before you start recording, make a trial recording to make sure that the camera is working correctly.
- Playback of images recorded with your product on other equipment and playback of images recorded or edited with other equipment on your product are not guaranteed.
- Sony can provide no guarantees in the event of failure to record, or loss of or damage to recorded images or audio data, due to a malfunction of the camera or recording media, etc. We recommend backing up important data.
- Once you format the memory card, all the data recorded on the memory card will be deleted and cannot be restored. Before formatting, copy the data to a computer or other device.

Backing up memory cards

Data may be corrupted in the following cases. Be sure to back up the data for protection.

- When the memory card is removed, the USB cable is disconnected, or the product is turned off in the middle of a read or write operation.
- When the memory card is used in locations subject to static electricity or electrical noise.

Database file error

- If you insert a memory card that does not contain an image database file into the product and turn on the power, the product automatically creates an image database file using some of the memory card's capacity. The process may take a long time and you cannot operate the product until the process is completed.

- If a database file error occurs, export all images to your computer using PlayMemories Home, and then format the memory card using this product.

Do not use/store the product in the following places

- In an extremely hot, cold or humid place
In places such as in a car parked in the sun, the camera body may become deformed and this may cause a malfunction.
- Storing under direct sunlight or near a heater
The camera body may become discolored or deformed, and this may cause a malfunction.
- In a location subject to rocking vibration
It may cause malfunctions and an inability to record data. In addition, the recording media may become unusable, and recorded data may be corrupted.
- Near strong magnetic place
- In sandy or dusty places
Be careful not to let sand or dust get into the product. This may cause the product to malfunction, and in some cases this malfunction cannot be repaired.
- In places with high humidity
This may cause the lens to mold.
- In areas where strong radio waves or radiation are being emitted
Recording and playback may not function correctly.

On moisture condensation

- If the product is brought directly from a cold to a warm location, moisture may condense inside or outside the product. This moisture condensation may cause a malfunction of the product.
- To prevent moisture condensation when you bring the product directly from a cold to a warm location, first put it in a plastic bag and seal it to prevent air from entering. Wait for about an hour until the temperature of the product has reached the ambient temperature.
- If moisture condensation occurs, turn off the product and wait about an hour for the moisture to evaporate. Note that if you attempt to shoot with moisture remaining inside the lens, you will be unable to record clear images.

Precaution on carrying

- Do not hold, hit, or apply excessive force to the following parts, if your camera is equipped with them. Also, take care to avoid getting your fingers or hand caught in the parts.
 - The lens part
 - The movable monitor part
 - The movable flash part
 - The movable viewfinder part
- Do not carry the camera with the tripod attached. This may cause the tripod socket hole to break.
- Do not sit down in a chair or other place with the camera in the back pocket of your trousers or skirt, as this may cause malfunction or damage the camera.

Notes on handling the product

- Before you connect the cable to the terminal, be sure to check the orientation of the terminal. Then, insert the cable straight. Do not insert or remove the cable forcefully. This may cause the terminal part to break.
- The camera uses magnetic parts including magnets. Do not bring objects affected by magnetism, including credit cards and floppy disks, close to the camera.
- The recorded image may be different from the image you monitored before recording.

On storing

- For lens-integrated cameras
Always attach the lens cap when you are not using the camera. (Only for models supplied with a lens cap)
- For interchangeable-lens cameras
Always attach the lens front cap or body cap when you are not using the camera. To prevent dust or debris from getting inside the camera, remove dust from the body cap before attaching it to the camera.

- If the camera is dirty after use, clean it. Water, sand, dust, salt, etc. left in the camera may cause a malfunction.

Notes on using lenses

- When using the power zoom lens, be careful not to get your fingers or any other objects caught in the lens. (Only for models with a power zoom feature or interchangeable lens cameras)
- If you must place the camera under a light source such as sunlight, attach the lens cap to the camera. (Only for models supplied with a lens cap or interchangeable lens cameras)
- When you shoot with backlighting, keep the sun sufficiently far away from the angle of view. Otherwise, the sunlight may enter the focus inside the camera and cause smoke or fire. Even if the sun is slightly away from the angle of view, it may still cause smoke or fire.
- Do not directly expose the lens to beams such as laser beams. That may damage the image sensor and cause the camera to malfunction.
- If the subject is too close, the image may show any dust or fingerprints on the lens. Wipe the lens with a soft cloth, etc.

Notes on the flash (Only for models with a flash)

- Keep your fingers away from the flash. The light-emitting part may get hot.
- Remove any dirt from the surface of the flash. Dirt on the surface of the flash may emit smoke or burn due to heat generated by the emission of light. If there is dirt/dust, clean it off with a soft cloth.
- Restore the flash to its original position after using it. Make sure that the flash portion is not sticking up. (Only for models with a movable flash)

Notes on the Multi Interface Shoe (Only for models with a Multi Interface Shoe)

- When attaching or detaching accessories such as an external flash to the Multi Interface Shoe, first turn the power to OFF. When attaching the accessory, confirm that it is firmly fastened to the camera.
- Do not use the Multi Interface Shoe with a commercially available flash that applies voltages of 250 V or more or has the opposite polarity of the camera. It may cause a malfunction.

Notes on the viewfinder and flash (Only for models with a viewfinder or a flash)

- Take care that your finger is not in the way when pushing the viewfinder or flash down. (Only for models with a movable viewfinder or a movable flash)
- If water, dust or sand adheres to the viewfinder or flash unit, it may cause a malfunction. (Only for models with a movable viewfinder or a movable flash)

Notes on the viewfinder (Only for models with a viewfinder)

- When shooting with the viewfinder, you may experience symptoms such as eyestrain, fatigue, travel sickness, or nausea. We recommend that you take a break at regular intervals when you are shooting with the viewfinder. In case you may feel uncomfortable, refrain from using the viewfinder until your condition recovers, and consult your doctor if necessary.
- Do not forcibly push down the viewfinder when the eyepiece is pulled out. It may cause a malfunction. (Only for models with a movable viewfinder and an eyepiece that can be pulled out)
- If you pan the camera while looking into the viewfinder or move your eyes around, the image in the viewfinder may be distorted or the color of the image may change. This is a characteristic of the lens or display device and is not a malfunction. When you shoot an image, we recommend that you look at the center area of the viewfinder.
- The image may be slightly distorted near the corners of the viewfinder. This is not a malfunction. When you want to see the full composition with all its details, you can also use the monitor.
- If you use the camera in a cold location, the image may have a trailing appearance. This is not a malfunction.

Notes on the monitor

- Do not press against the monitor. The monitor may be discolored and that may cause a malfunction.
- If the monitor has drops of water or other liquids on it, wipe it with a soft cloth. If the monitor stays wet, the surface of the monitor may change or deteriorate. This may cause a malfunction.
- If you use the camera in a cold location, the image may have a trailing appearance. This is not a malfunction.

On image data compatibility

-
This product conforms with DCF (Design rule for Camera File system) universal standard established by JEITA (Japan Electronics and Information Technology Industries Association).

Services and software provided by other companies

Network services, content, and the [operating system and] software of this Product may be subject to individual terms and conditions and changed, interrupted or discontinued at any time and may require fees, registration and credit card information.

Notes on connecting to the Internet

Connect the camera to the network via a router, or connect to a LAN port with the same function. If you connect using a different method, security problems may occur.

5-016-934-11(1) Copyright 2020 Sony Corporation

Digital Camera
ZV-1

On cleaning

Cleaning the lens

- Do not use a cleaning solution containing organic solvents, such as thinner, or benzine.
- When cleaning the lens surface, remove dust with a commercially available blower. In case of dust that sticks to the surface, wipe it off with a soft cloth or tissue paper slightly moistened with lens cleaning solution. Wipe in a spiral pattern from the center to the outside. Do not spray lens cleaning solution directly onto the lens surface.

Cleaning the product surface

Clean the product surface with a soft cloth slightly moistened with water, then wipe the surface with a dry cloth. To prevent damage to the finish or casing:

- Do not expose the product to chemical products such as thinner, benzine, alcohol, disposable cloths, insect repellent, sunscreen or insecticide.
- Do not touch the product with any of the above on your hand.
- Do not leave the product in contact with rubber or vinyl for a long time.

Cleaning the monitor

- If you wipe the monitor firmly using tissue paper, etc., the coating may be scratched.
- If the monitor becomes dirty with fingerprints or dust, gently remove the dust from the surface, and then clean the monitor using soft cloth, etc.

Number of recordable images

When you insert a memory card into the camera and turn the camera on, the number of images that can be recorded (should you continue to shoot using the current settings) is displayed on the screen.

Note

- When “0” (the number of recordable images) flashes in orange, the memory card is full. Replace the memory card with another one, or delete images from the current memory card.
- When “NO CARD” flashes in orange, it means no memory card has been inserted. Insert a memory card.

The number of images that can be recorded on a memory card



The table below shows the approximate number of images that can be recorded on a memory card formatted with this camera. The values are defined using Sony standard memory cards for testing.

The values may vary depending on the shooting conditions and the type of memory card used.

[ JPEG Image Size]: [L: 20M]

[ Aspect Ratio] is set to [3:2] *1

(Units: Images)

 JPEG Quality/  File Format	8 GB	32 GB	64 GB	256 GB
Standard	1150	4750	9600	37500
Fine	690	2750	5500	22000
Extra fine	510	2050	4150	16000
RAW & JPEG *2	230	940	1850	7500
RAW	355	1400	2850	11000

*1 When [ Aspect Ratio] is set to other than [3:2], you can record more images than the numbers shown in the table above (except when [RAW] is selected).

*2 [ JPEG Quality] when [RAW & JPEG] is selected: [Fine]



Note

- Even if the number of recordable images is higher than 9999 images, “9999” will appear.
- The numbers shown are when using a Sony memory card.



Digital Camera
ZV-1

Recordable movie times

The table below shows the approximate total recording times using a memory card formatted with this camera. The values may vary depending on the shooting conditions and the type of memory card used.

The recording times for when [ File Format] is set to [XAVC S 4K] and [XAVC S HD] are recording times when shooting with [ Proxy Recording] set to [Off].

(h (hour), min (minute))

 File Format/  Record Setting	8 GB	32 GB	64 GB	256 GB
XAVC S 4K 30p 100M/25p 100M	8 min	35 min	1 h 15 min	5 h 5 min
XAVC S 4K 30p 60M/25p 60M	10 min	55 min	2 h	8 h 5 min
XAVC S 4K 24p 100M*/–	8 min	35 min	1 h 15 min	5 h 5 min
XAVC S 4K 24p 60M*/–	10 min	55 min	2 h	8 h 5 min
XAVC S HD 120p 100M/100p 100M	8 min	35 min	1 h 15 min	5 h 5 min
XAVC S HD 120p 60M/100p 60M	10 min	55 min	2 h	8 h 5 min
XAVC S HD 60p 50M/50p 50M	15 min	1 h 10 min	2 h 25 min	10 h
XAVC S HD 60p 25M/50p 25M	30 min	2 h 20 min	4 h 50 min	19 h 30 min
XAVC S HD 30p 50M/25p 50M	15 min	1 h 10 min	2 h 25 min	10 h
XAVC S HD 30p 16M/25p 16M	50 min	3 h 40 min	7 h 25 min	29 h 55 min
XAVC S HD 24p 50M*/–	15 min	1 h 10 min	2 h 25 min	10 h
AVCHD 60i 24M(FX)/50i 24M(FX)	40 min	2 h 55 min	6 h	24 h 15 min
AVCHD 60i 17M(FH)/50i 17M(FH)	55 min	4 h 5 min	8 h 15 min	33 h 15 min

* Only when [NTSC/PAL Selector] is set to NTSC.

- The duration of time available for movie recording varies depending on the file format/recording settings for movies, memory card, ambient temperature, Wi-Fi network environment, condition of the camera before you start recording, and condition of the charging of the battery.

The maximum continuous recording time for a single movie shooting session is approximately 13 hours. When recording XAVC S 4K or XAVC S HD movies in 120p/ 100p, the amount of time available for continuous recording is approximately 5 minutes (a product specification limit). However, when [Auto Power OFF Temp.] is set to [High], you can record movies continuously for over 5 minutes.

Note

- The recordable time of movies varies because the camera is equipped with VBR (Variable Bit-Rate), which automatically adjusts image quality depending on the shooting scene. When you record a fast-moving subject, the image is clearer but the recordable time is shorter because more memory is required for recording. The recordable time also varies depending on the shooting conditions, the subject or the image quality/size settings.
- The times shown are recordable times using a Sony memory card.

Notes on continuous movie recording

- High-quality movie recording and high-speed continuous shooting require large amounts of power. Therefore, if you continue to shoot, the temperature inside the camera will rise, especially that of the image sensor. In such cases, the camera will turn off automatically because the surface of the camera is heated to a high temperature or the high temperature affects the quality of the images or the internal mechanism of the camera.
- The duration of time available for continuous movie recording when the camera records with the default settings after the power has been turned off for a while is as follows. The values indicate the continuous time from when the camera starts recording until the camera stops recording.

When [Auto Power OFF Temp.] is set to [Standard]



 File Format	XAVC S HD	XAVC S 4K
Ambient temperature: 20°C (68°F)	Approx. 30 minutes	Approx. 5 minutes
Ambient temperature: 30°C (86°F)	Approx. 30 minutes	Approx. 5 minutes
Ambient temperature: 40°C (104°F)	Approx. 20 minutes	Approx. 5 minutes

When [Auto Power OFF Temp.] is set to [High]

 File Format	XAVC S HD	XAVC S 4K
Ambient temperature: 20°C (68°F)	Approx. 30 minutes	Approx. 30 minutes
Ambient temperature: 30°C (86°F)	Approx. 30 minutes	Approx. 30 minutes
Ambient temperature: 40°C (104°F)	Approx. 20 minutes	Approx. 20 minutes

XAVC S HD (60p 50M/50p 50M, when the camera is not connected via Wi-Fi)

XAVC S 4K (24p 60M/25p 60M, when the camera is not connected via Wi-Fi)

- The duration of time available for movie recording varies with the temperature, file format/record setting for movies, Wi-Fi network environment, or condition of the camera before you start recording. If you frequently recompose or shoot images after the power is turned on, the temperature inside the camera will rise and the recording time available will be shorter.
- If  (Overheating warning) appears, the temperature of the camera has risen.
- If the camera stops movie recording due to a high temperature, leave it for some time with the power turned off. Start recording after the temperature inside the camera drops fully.
- If you observe the following points, you will be able to record movies for longer periods of time.
 - Keep the camera out of direct sunlight.
 - Turn the camera off when it is not being used.
- When [ File Format] is set to [AVCHD], the file size of movies is limited to approx. 2 GB. If the movie file size reaches approx. 2 GB during recording, a new movie file will be created automatically.

Related Topic

- [Battery life and number of recordable images](#)

Digital Camera
ZV-1

Using the battery charger abroad

You can use the battery charger (sold separately) in any country or region where the power supply is within 100 V to 240 V AC and 50 Hz/60 Hz.

Depending on the country/region, a converting plug adaptor may be needed to connect to a wall outlet (wall socket). Consult a travel agency, etc., and prepare one in advance.

Note

- Do not use an electronic voltage transformer as doing so may cause a malfunction.

Digital Camera
ZV-1

AVCHD format

The AVCHD format was developed for high-definition digital video cameras when recording an HD (High-Definition) signal using high-efficiency compression coding technology. The MPEG-4 AVC/H.264 format is used to compress video data, and the Dolby Digital or Linear PCM system is used to compress audio data.

The MPEG-4 AVC/H.264 format is capable of compressing images at higher efficiency than that of the conventional image compressing format.

- As the AVCHD format uses compression coding technology, the picture may be unstable in scenes where the screen, angle of view, or brightness, etc. change drastically, but this is not a malfunction.

Digital Camera
ZV-1

License

Notes on the License

This product comes with software that are used based on licensing agreements with the owners of that software. Based on requests by the owners of copyright of these software applications, we have an obligation to inform you of the following. Licenses (in English) are recorded in the internal memory of your product. Establish a Mass Storage connection between the product and a computer to read licenses in the "PMHOME" - "LICENSE" folder.

THIS PRODUCT IS LICENSED UNDER THE AVC PATENT PORTFOLIO LICENSE FOR THE PERSONAL USE OF A CONSUMER OR OTHER USES IN WHICH IT DOES NOT RECEIVE REMUNERATION TO

(i) ENCODE VIDEO IN COMPLIANCE WITH THE AVC STANDARD ("AVC VIDEO")

AND/OR

(ii) DECODE AVC VIDEO THAT WAS ENCODED BY A CONSUMER ENGAGED IN A PERSONAL ACTIVITY AND/OR WAS OBTAINED FROM A VIDEO PROVIDER LICENSED TO PROVIDE AVC VIDEO.

NO LICENSE IS GRANTED OR SHALL BE IMPLIED FOR ANY OTHER USE. ADDITIONAL INFORMATION INCLUDING THAT RELATING TO PROMOTIONAL, INTERNAL AND COMMERCIAL USES AND LICENSING MAY BE OBTAINED FROM MPEG LA, L.L.C.

SEE [HTTP://WWW.MPEGLA.COM](http://www.mpegla.com)

On GNU GPL/LGPL applied software

The software that is eligible for the following GNU General Public License (hereinafter referred to as "GPL") or GNU Lesser General Public License (hereinafter referred to as "LGPL") are included in the product.

This informs you that you have a right to have access to, modify, and redistribute source code for these software programs under the conditions of the supplied GPL/LGPL.

Source code is provided on the web.

Use the following URL to download it.

<http://oss.sony.net/Products/Linux/>

We would prefer you do not contact us about the contents of source code.

Digital Camera
ZV-1

Specifications

Camera

[System]

Camera Type

Digital Camera

[Image sensor]

Image format

13.2 mm × 8.8 mm (1.0 type), CMOS image sensor

Effective pixel number of camera

Approx. 20 100 000 pixels

Total pixel number of camera

Approx. 21 000 000 pixels

[Lens]

ZEISS Vario-Sonnar T *

f = 9.4 mm – 25.7 mm

Angle of view: 84° - 34° (35 mm format equivalent: 24 mm - 70 mm)

F1.8 (W) – F2.8 (T)

[SteadyShot]

System

Optical

[Auto focus system]

Detection system

Phase detection system/Contrast detection system

[Monitor]

LCD monitor

7.5 cm (3.0 type) TFT drive, touch panel

Total number of dots

921 600 dots

[Recording format]

File format

JPEG (DCF Ver. 2.0, Exif Ver. 2.31, MPF Baseline) compliant, RAW (Sony ARW 2.3 format)

Movie (XAVC S format)

MPEG-4 AVC/H.264 XAVC S ver.1.0 format compliant

Video: MPEG-4 AVC/H.264

Audio: LPCM 2ch (48kHz 16bit)

Movie (AVCHD format)

AVCHD format Ver. 2.0 compatible

Video: MPEG-4 AVC/H.264

Audio: Dolby Digital 2ch, equipped with Dolby Digital Stereo Creator

- Manufactured under license from Dolby Laboratories.

[Recording media]

Memory Stick, SD cards

[Input/output terminals]

Multi/Micro USB Terminal*

Hi-Speed USB (USB 2.0)

* Supports Micro USB compatible devices.

HDMI

HDMI type D micro jack

(Microphone) terminal

Ø3.5 mm Stereo mini jack

[Power, general]

Rated input

3.6 V  , 2.1 W

Operating temperature

0 to 40°C (32 to 104°F)

Storage temperature

-20 to 55°C (-4 to 131°F)

Dimensions (W/H/D) (Approx.)

105.5 × 60.0 × 43.5 mm

(4 1/4 × 2 3/8 × 1 3/4 in.)

Mass (Approx.)

294 g (10.4 oz) (including battery pack, SD card)

Microphone

Stereo

Speaker

Monaural

Exif Print

Compatible

DPOF

Compatible

PRINT Image Matching III

Compatible

[Wireless LAN]

Supported format

IEEE 802.11 b/g/n

Frequency band

2.4 GHz

Security

WEP/WPA-PSK/WPA2-PSK

Connection method

Wi-Fi Protected Setup™ (WPS)/Manual

Access method

Infrastructure mode

[Bluetooth communications]

Bluetooth standard Ver. 4.1

Frequency band

2.4 GHz

Rechargeable battery pack NP-BX1**Rated voltage**

3.6 V 

Design and specifications are subject to change without notice.

5-016-934-11(1) Copyright 2020 Sony Corporation

Trademarks

- Memory Stick and  are trademarks or registered trademarks of Sony Corporation.
- XAVC S and  are registered trademarks of Sony Corporation.
- “Multi Interface Shoe” is a trademark of Sony Corporation.
- AVCHD and AVCHD logotype are trademarks of Panasonic Corporation and Sony Corporation.
- Mac is a trademark of Apple Inc., registered in the United States and other countries.
- iPhone and iPad are trademarks of Apple Inc., registered in the U.S. and other countries.
- Blu-ray Disc™ and Blu-ray™ are trademarks of the Blu-ray Disc Association.
- DLNA and DLNA CERTIFIED are trademarks of Digital Living Network Alliance.
- Dolby, Dolby Audio and double-D symbol are trademarks of Dolby Laboratories.
- The terms HDMI, HDMI High-Definition Multimedia Interface, and the HDMI Logo are trademarks or registered trademarks of HDMI Licensing Administrator, Inc.
- Microsoft and Windows are registered trademarks or trademarks of Microsoft Corporation in the United States and/or other countries.
- SDXC logo is a trademark of SD-3C, LLC.
- Android and Google Play are trademarks or registered trademarks of Google LLC.
- Wi-Fi, the Wi-Fi logo and Wi-Fi Protected Setup are registered trademarks or trademarks of the Wi-Fi Alliance.
- The Bluetooth® word mark and logos are registered trademarks owned by the Bluetooth SIG, Inc. and any use of such marks by Sony Corporation is under license.
- QR Code is a trademark of Denso Wave Inc.
- In addition, system and product names used in this manual are, in general, trademarks or registered trademarks of their respective developers or manufacturers. However, the ™ or ® marks may not be used in all cases in this manual.

Troubleshooting

If you experience trouble with the product, try the following solutions.

- 1 If a message such as “C/E:□□:□□” appears on the screen, refer to the self-diagnosis display.
- 2 Remove the battery pack, wait for about one minute, re-insert the battery pack, then turn on the power.
- 3 Initialize the settings.
- 4 Consult your dealer or local authorized service facility. Additional information on this product and answers to frequently asked questions can be found at our Customer Support Website.
<https://www.sony.net/>

Related Topic

- [Self-diagnosis display](#)
- [Setting Reset](#)

Digital Camera
ZV-1

Self-diagnosis display

If a code starting with a letter of the alphabet appears, the self-diagnosis function on this product is working. The last two digits (indicated by □□) will differ depending on the state of this product.

If you cannot solve the problem even after trying the following corrective actions a few times, this product may need repair. Contact your Sony dealer or local authorized Sony service facility.

C:32:□□

- There is trouble with the product's hardware. Turn the power off and on again.

C:13:□□

- This product cannot read or write data on the memory card. Try turning off and on this product again, or taking out and inserting the memory card several times.
- An unformatted memory card is inserted. Format the memory card.
- The inserted memory card cannot be used with this product, or the data is damaged. Insert a new memory card.

E:61:□□

E:62:□□

E:91:□□

- A product malfunction has occurred. Initialize this product, then turn the power on again.

E:94:□□

- There is a malfunction when writing or deleting data. Repair is required. Contact your Sony dealer or local authorized Sony service facility. Be prepared to give all numbers in the error code beginning from the E.

Warning messages

Set Area/Date/Time.

- Set the area, date and time. If you have not used the product for a long time, charge the internal rechargeable backup battery.

Unable to use memory card. Format?

- The memory card was formatted on a computer and the file format was modified. Select [Enter] and then format the memory card. You can use the memory card again, however, all previous data in the memory card is erased. It may take some time to complete the format. If the message still appears, change the memory card.

Memory Card Error

- An incompatible memory card is inserted.
- Formatting has failed. Format the memory card again.

Unable to read memory card. Reinsert memory card.

- An incompatible memory card is inserted.
- The memory card is damaged.
- The terminal section of the memory card is dirty.

Memory card locked.

- You are using a memory card with a write-protect switch or a delete-protect switch with the switch set to the LOCK position. Set the switch to the record position.

Cannot open the shutter since the memory card is not inserted.

- No memory card has been inserted.
- To release the shutter without inserting a memory card into the camera, set [Release w/o Card] to [Enable]. In this case, images will not be saved.

This memory card may not be capable of recording and playing normally.

- An incompatible memory card is inserted.

Processing...

- When performing noise reduction, the reduction process takes place. You cannot do any further shooting during this reduction process.

Unable to display.

- Images recorded with other products or images modified with a computer may not be displayed.
- Processing on the computer such as deletion of the image files may cause inconsistencies in the image database files. Repair the image database files.

Unable to print.

- You tried to mark RAW images with a DPOF mark.

Internal temp. high. Allow it to cool.

- The product has become hot because you have been shooting continuously. Turn the power off and cool the product and wait until the product is ready to shoot again.

(Overheating warning)

- You have been recording images for a long time, the product temperature has risen.

(Database file full)

- The number of images exceeds that for which date management in a database file by the product is possible.

(Database file error)

- Unable to register to the database file. Import all the images to a computer using PlayMemories Home and recover the memory card.

Image DataBase File error

- There is something wrong in the Image Database File. Select [Setup] → [Recover Image DB].

System Error

Camera Error. Turn power off then on.

- Remove the battery pack, and then re-insert it. If the message appears frequently, consult local authorized Sony service facility.

Image Database File error. Recover?

- You cannot record and play back an AVCHD movie because the Image Database File is damaged. Recover the Image Database File following the on-screen instructions.

Unable to magnify.

Unable to rotate image.

- Images recorded with other products may not be enlarged or rotated.



Cannot create more folders.

- A folder in the memory card has the first three digits "999." You cannot create any more folders on this camera.

Related Topic

- [Notes on memory card](#)
- [Format](#)

Recommended pages

-  **Looking for valuable information, such as essential points on shooting (Tutorials)**
This website introduces convenient functions, ways of usage, and setting examples. Refer to the website when you set up your camera. (Another window will open.)
-  **ZV-1 accessories compatibility information**
This website provides the accessories compatibility information. (Another window will open.)