

KRAMER VP-553 USER MANUAL



Table of Contents

[Table of Contents](#)

[Achieving the Best Performance](#)

[Safety Instructions](#)

[Recycling Kramer Products](#)

[Using the USB Switcher](#)

[Using Twisted Pair Cable for HDBT](#)

[Shielded Twisted Pair \(STP\) / Unshielded Twisted Pair \(UTP\)](#)

[Defining the VP-553 Presentation Switcher/Scaler](#)

[Figure 1: VP-553 Presentation Switcher/Scaler Front Panel](#)

Figure 2: VP-553 Presentation Switcher/Scaler Rear Panel

Figure 3: Connecting the VP-553 Presentation Switcher / Scaler

Connecting the Balanced Stereo Audio Input and Outputs

Figure 4: Balanced Stereo Audio Connection

Figure 5: Unbalanced Stereo Audio Output Connection

Figure 6: balanced Stereo Audio Input Connection

Figure 7: Unbalanced Stereo Audio Input Connection

Controlling via the Front Panel Buttons

Using the OSD Menu

Connecting to the VP-553 via RS-232

Operating via Ethernet

Figure 8: Local Area Connection Properties Window

Figure 9: Internet Protocol Version 4 Properties Window

Figure 10: Internet Protocol Version 6 Properties Window

Figure 11: Internet Protocol Properties Window

Controlling via the Infrared Remote Control Transmitter

Figure 12: Infrared Remote Control Transmitter

Browsing the VP-553 Web Pages

The Switching Page

Figure 13: The Loading Page

Figure 14: Enter Username and Password

Figure 15: The Switching Page

Figure 16: Switching Page - Input and Output Icons

Figure 17: Edit Output Buttons

Figure 18: Edit Output Buttons

Figure 19: Edit Input Buttons

Figure 20: Switching Page - HDMI input Window

Figure 21: Switching Page - HDBT input Window

Figure 22: Switching Page - SID-X2N Setup Icon

Figure 23: Switching Page - SID-X2N Setup Window

Figure 24: Switching Page - PC, TP or CV input Window

Figure 25: HDBT IR transmission Example

The Scaler Page

Figure 26: The Scaler Page - Output 1

Figure 27: The Scaler Page - Output 1 for an Analog Input

Figure 28: The Scaler Page - Output 2

The Device Settings Page

Figure 29: The Device Settings Page

Figure 30: The Device Settings Page - Static IP Confirmation

Figure 31: The Device Settings Page - Uploading the New Firmware File

Figure 32: The Device Settings Page - New Firmware Updated

The USB Routing Page

Figure 33: The Device Settings Page - Soft Factory Reset Message

Figure 34: The USB Routing Page

The Audio Settings Page

Figure 35: The USB Tied to a Selected Input

Figure 36: The Audio Settings Page - Inputs

Figure 37: The Audio Settings Page - Output 1

Figure 38: The Audio Settings Page - Output 2

Figure 39: The Audio Settings Page - Monitor

The EDID Page

Figure 40: The EDID Page

Figure 41: The EDID Page - Copying the Native Timing

Figure 42: The EDID Page - Copying the Default

The Data Routing Page

Figure 43: The EDID Page -The Copy EDID Results

The Authentication Page

[Figure 44: The Data Routing Page](#)

[The About Page](#)

[Figure 45: The Authentication Page](#)

[Figure 46: The About Page](#)

[Default Communication Parameters](#)

[Input Resolutions](#)

[Kramer Protocol 3000 Syntax](#)

[Kramer Protocol 3000 - Command List](#)

[Kramer Protocol 3000 - Detailed Commands](#)

[Other Manuals](#)[Lib Projects](#)



KRAMER ELECTRONICS LTD.

USER MANUAL

MODEL:

VP-553

Presentation Switcher/Scaler

P/N: 2900-300326 Rev 2



VP-553 Quick Start Guide

This guide helps you install and use your product for the first time. For more detailed information, go to http://www.kramerelectronics.com/support/product_downloads.asp to download the latest manual or scan the QR code on the left.

Step 1: Check what's in the box

- The **VP-553** Presentation Switcher/Scaler
- 1 Power cord
- 1 Set of rack ears
- IR remote control transmitter with batteries
- 4 Rubber feet
- 1 Quick start guide

Save the original box and packaging materials in case you need to return your product for service.

Step 2: Install the VP-553

To rack mount the machine attach both ear brackets to the machine (by removing the five screws from each side of the machine and replacing those screws through the ear brackets) or place the machine on a table.

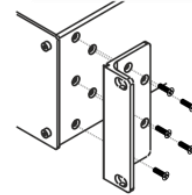

Step 3: Connect inputs and outputs

Always switch OFF the power on each device before connecting it to your **VP-553**.

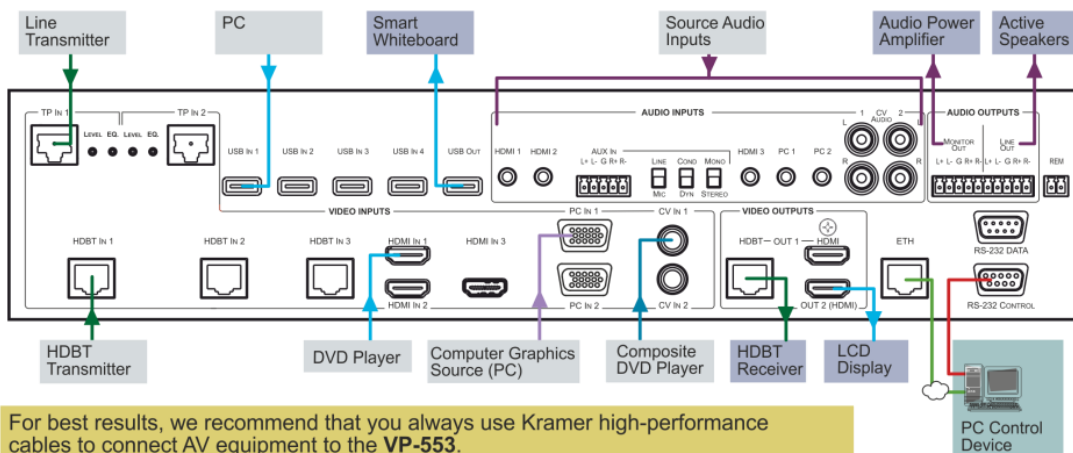

For best results, we recommend that you always use Kramer high-performance cables to connect AV equipment to the **VP-553**.

RJ-45 Pinout

For the Ethernet and HDBaseT connectors, see the proper wiring diagram below:

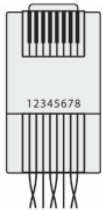

EIA / TIA 568B	
PIN	Wire Color
1	Orange / White
2	Orange
3	Green / White
4	Blue
5	Blue / White
6	Green
7	Brown / White
8	Brown

For optimum range and performance use Kramer's **BC-HDKat6a** cable. These specially built cables significantly outperform regular CAT 6 cables.

Connect the audio output:

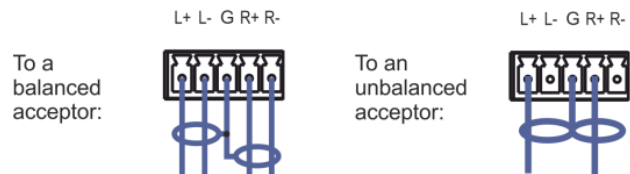

Connect the audio AUX IN input:

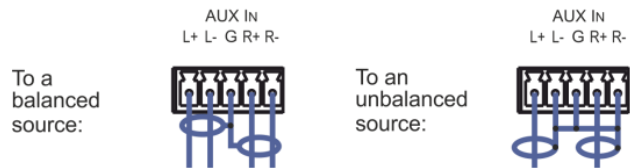

Step 4: Connect the power

Connect AC power to the rear of the **VP-553**, switch on its power and then switch on the power on each device.

Step 5: Set operation parameters via OSD menu

To View the OSD, press the OSD SELECT button until the front-panel OSD LED corresponding to the output you are viewing is lit.

Enter the OSD menu via the MENU button on the front panel or the IR remote control transmitter. Select a menu item and set parameters as required.

If you cannot see any images, verify that the display, TV, or projector is in good working order and is connected to the **VP-553**. If you still don't see an image, press and hold the RESET TO XGA/720P button for 2 seconds to reset the output to XGA or 720p resolution.

Mode	Function
OUTPUT 1	Set the output 1 parameters
OUTPUT 2	Set the output 2 parameters
AUDIO OUT	Set the audio output parameters
AUDIO SET	Set the audio input parameters
USB	Set the USB ports behavior
OSD	Set the OSD parameters
FACTORY	Select YES to reset to the default parameters.
ETHER(NET)	IP MODE, SET STATIC IP, CONTROL PORT
MISC.	Select the IR transmission route for each of the units that are connected to the HDBT connectors (IN+OUT): HDBT1 (IR OUT), HDBT2 (IR OUT), HDBT3 (IR OUT), HDBT OUT (IR OUT), DATA UART OUT
INFO.	Displays the RESOLUTION, HDCP, DIP SWITCH, VERSION

Step 6: Control peripheral devices via IR remote controller:

You can use a remote control transmitter (that is used for controlling a peripheral device, for example, a DVD player) to send commands (to the A/V equipment) from/to any of the transmitters /receiver connected to the HDBT connectors.

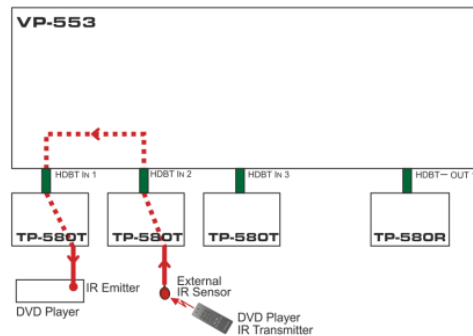

Step 7: Operate via the front panel buttons and via the:

IR Remote Controller



RS-232 and Ethernet

RS-232	
Baud Rate:	Any baud rate up to 115,200
Data Bits:	8
Stop Bits:	1
Parity:	None
Command Format	ASCII
Example (Route the video from the HDMI3 input to the HDMI1 output port):	#ROUTE 1,1,2<cr>
Ethernet	
To reset the IP settings to the factory reset values go to : Menu-> Factory-> RESET->Change the option to YES and press Enter	
IP Address:	192.168.1.39
Subnet mask:	255.255.255.0
Default gateway:	192.168.1.254
TCP Port #:	Not supported
Default UDP Port #:	50000
Maximum UDP Ports:	4
Full Factory Reset	
OSD	Go to : Menu-> Factory-> RESET->Change the option to YES and press Enter

Embedded Web Page

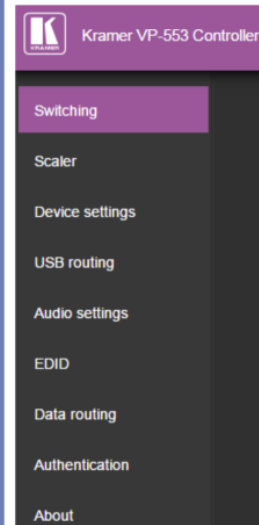

Contents

1	Introduction	1
2	Getting Started	2
2.1	Achieving the Best Performance	2
2.2	Safety Instructions	3
2.3	Recycling Kramer Products	3
3	Overview	4
3.1	Using the USB Switcher	6
3.2	Using Twisted Pair Cable for HDBT	6
3.3	Shielded Twisted Pair (STP) / Unshielded Twisted Pair (UTP)	7
3.4	Defining the VP-553 Presentation Switcher/Scaler	7
4	Installing in a Rack	11
5	Connecting the VP-553	12
5.1	Connecting the Balanced Stereo Audio Input and Outputs	15
6	Controlling the VP-553	16
6.1	Controlling via the Front Panel Buttons	16
6.2	Using the OSD Menu	17
6.3	Connecting to the VP-553 via RS-232	22
6.4	Operating via Ethernet	23
6.5	Controlling via the Infrared Remote Control Transmitter	27
7	Using the Embedded Web Pages	28
7.1	Browsing the VP-553 Web Pages	28
7.2	The Switching Page	29
7.3	The Scaler Page	36
7.4	The Device Settings Page	39
7.5	The USB Routing Page	41
7.6	The Audio Settings Page	42
7.7	The EDID Page	45
7.8	The Data Routing Page	47
7.9	The Authentication Page	48
7.10	The About Page	49
8	Technical Specifications	50
8.1	Default Communication Parameters	51
8.2	Input Resolutions	52
9	The VP-553 RS-232 Communication Protocol	53
9.1	Kramer Protocol 3000 Syntax	53
9.2	Kramer Protocol 3000 – Command List	56
9.3	Kramer Protocol 3000 – Detailed Commands	58

Figures

Figure 1:	VP-553 Presentation Switcher/Scaler Front Panel	8
Figure 2:	VP-553 Presentation Switcher/Scaler Rear Panel	9
Figure 3:	Connecting the VP-553 Presentation Switcher / Scaler	14
Figure 4:	Balanced Stereo Audio Connection	15
Figure 5:	Unbalanced Stereo Audio Output Connection	15
Figure 6:	balanced Stereo Audio Input Connection	15
Figure 7:	Unbalanced Stereo Audio Input Connection	15

Figure 8: Local Area Connection Properties Window	24
Figure 9: Internet Protocol Version 4 Properties Window	25
Figure 10: Internet Protocol Version 6 Properties Window	25
Figure 11: Internet Protocol Properties Window	26
Figure 12: Infrared Remote Control Transmitter	27
Figure 13: The Loading Page	29
Figure 14: Enter Username and Password	29
Figure 15: The Switching Page	30
Figure 16: Switching Page – Input and Output Icons	30
Figure 17: Edit Output Buttons	31
Figure 18: Edit Output Buttons	31
Figure 19: Edit Input Buttons	32
Figure 20: Switching Page – HDMI input Window	33
Figure 21: Switching Page – HDBT input Window	33
Figure 22: Switching Page – SID-X2N Setup Icon	34
Figure 23: Switching Page – SID-X2N Setup Window	34
Figure 24: Switching Page – PC, TP or CV input Window	34
Figure 25: HDBT IR transmission Example	35
Figure 26: The Scaler Page – Output 1	37
Figure 27: The Scaler Page – Output 1 for an Analog Input	37
Figure 28: The Scaler Page – Output 2	38
Figure 29: The Device Settings Page	39
Figure 30: The Device Settings Page – Static IP Confirmation	39
Figure 31: The Device Settings Page – Uploading the New Firmware File	40
Figure 32: The Device Settings Page – New Firmware Updated	40
Figure 33: The Device Settings Page – Soft Factory Reset Message	41
Figure 34: The USB Routing Page	41
Figure 35: The USB Tied to a Selected Input	42
Figure 36: The Audio Settings Page – Inputs	43
Figure 37: The Audio Settings Page – Output 1	43
Figure 38: The Audio Settings Page – Output 2	44
Figure 39: The Audio Settings Page – Monitor	44
Figure 40: The EDID Page	45
Figure 41: The EDID Page – Copying the Native Timing	46
Figure 42: The EDID Page – Copying the Default	46
Figure 43: The EDID Page –The Copy EDID Results	47
Figure 44: The Data Routing Page	48
Figure 45: The Authentication Page	49
Figure 46: The About Page	49

1 Introduction

Welcome to Kramer Electronics! Since 1981, Kramer Electronics has been providing a world of unique, creative, and affordable solutions to the vast range of problems that confront video, audio, presentation, and broadcasting professionals on a daily basis. In recent years, we have redesigned and upgraded most of our line, making the best even better!

Our 1,000-plus different models now appear in 14 groups that are clearly defined by function: GROUP 1: Distribution Amplifiers; GROUP 2: Switchers and Routers; GROUP 3: Control Systems; GROUP 4: Format/Standards Converters; GROUP 5: Range Extenders and Repeaters; GROUP 6: Specialty AV Products; GROUP 7: Scan Converters and Scalers; GROUP 8: Cables and Connectors; GROUP 9: Room Connectivity; GROUP 10: Accessories and Rack Adapters; GROUP 11: Sierra Video Products; GROUP 12: Digital Signage; GROUP 13: Audio; and GROUP 14: Collaboration.

Congratulations on purchasing your Kramer **VP-553** Presentation Switcher/Scaler. This product, which incorporates HDMI™ technology, is ideal for:

- Projection systems in conference rooms, boardrooms, hotels and churches
- Video conferencing setups

2 Getting Started

We recommend that you:

- Unpack the equipment carefully and save the original box and packaging materials for possible future shipment
- Review the contents of this user manual



Go to http://www.kramerelectronics.com/support/product_downloads.asp to check for up-to-date user manuals, application programs, and to check if firmware upgrades are available (where appropriate).

2.1 Achieving the Best Performance

To achieve the best performance:

- Use only good quality connection cables (we recommend Kramer high-performance, high-resolution cables) to avoid interference, deterioration in signal quality due to poor matching, and elevated noise levels (often associated with low quality cables)
- Do not secure the cables in tight bundles or roll the slack into tight coils
- Avoid interference from neighboring electrical appliances that may adversely influence signal quality
- Position your Kramer **VP-553** away from moisture, excessive sunlight and dust



This equipment is to be used only inside a building. It may only be connected to other equipment that is installed inside a building.

2.2 Safety Instructions



Caution: There are no operator serviceable parts inside the unit

Warning: Use only the power cord that is supplied with the unit

Warning: Do not open the unit. High voltages can cause electrical shock! Servicing by qualified personnel only

Warning: Disconnect the power and unplug the unit from the wall before installing

2.3 Recycling Kramer Products

The Waste Electrical and Electronic Equipment (WEEE) Directive 2002/96/EC aims to reduce the amount of WEEE sent for disposal to landfill or incineration by requiring it to be collected and recycled. To comply with the WEEE Directive, Kramer Electronics has made arrangements with the European Advanced Recycling Network (EARN) and will cover any costs of treatment, recycling and recovery of waste Kramer Electronics branded equipment on arrival at the EARN facility. For details of Kramer's recycling arrangements in your particular country go to our recycling pages at <http://www.kramerelectronics.com/support/recycling/>.

3 Overview

The **VP-553** is a high-performance 6x2 presentation switcher/scaler for HDMI, HDBaseT and analog signals, and a 4x1 USB switcher. The unit has dual, independent, scaled outputs, the first on both HDMI and HDBaseT connectors, and the second on an HDMI connector. Both can take from the six digital inputs: three HDBaseT and three HDMI signals; while the first also includes analog inputs – for two computer graphics signals, two composite video and two analog TP inputs. Analog, digital and embedded audio are supported, and the unit also includes a microphone input and rich DSP features.

The **VP-553** features:

- Pix-Perfect™ scaling technology - Kramer's precision pixel mapping and high quality scaling technology. High-quality 3:2 and 2:2 pull down de-interlacing and full up- and down-scaling of video input signals
- System Range for the HDBT inputs and outputs - Up to 70m (230ft)



For optimum range and performance using HDBaseT™, use Kramer's **BC-HDKat6a** cable. Note that the transmission range depends on the signal resolution, source and display used. The distance using non-Kramer CAT 6 cable may not reach these ranges.

- System Range for the TP inputs and outputs - over 250m (more than 820ft)



For optimum range and performance using TP, use Kramer's **BC-STP** cable where skewing is not an issue or the Kramer **BC-XTP** Unshielded Twisted Pair (UTP) skew-free cable. Note that the transmission range depends on the signal resolution, source and display used. The distance using non-Kramer CAT 6 cable may not reach these ranges.

- HDTV compatibility
- HDCP compliance - the HDCP (High Definition Content Protection) license agreement allows copy-protected data on the HDMI input to pass only to the HDMI outputs
- Video inputs - three HDMI connectors, two VGA on 15-pin HD connectors each with unbalanced stereo audio on 3.5mm connectors, two composite video on RCA connectors with unbalanced stereo audio on RCA connectors, three HDBaseT on RJ-45 connectors and two analog TP on RJ-45 connectors

- Two scaled HDMI outputs (OUT 1 also outputs HDBaseT)
- Output resolutions - HDTV and computer graphics and 1080p/UXGA with selectable refresh rates
- A 4x1 USB switcher that can be set to follow the switching of the video layer or can be used as an independent switcher
- OSD (On Screen Display) - for easy setup and adjustment, accessible via the IR remote control and via the front panel buttons
- Powerful audio features via DSP technology
- Input and output audio level adjustment
- Selectable microphone talkover or mix modes
- Automatic audio detection and selection of the HDMI input source (the default selection is HDMI). If not present, the unit uses the audio from the analog input. Manual audio selection is also available
- Audio inputs - three analog HDMI audio and two analog PC audio on 3.5mm mini jacks; two stereo CV audio on RCA connectors each with individual level controls
- A microphone input - dynamic or condenser (with 48V phantom voltage)
- Audio outputs - two balanced stereo audio on terminal blocks
- Multiple aspect ratio selections - full, over scan, under scan, letter box, pan scan and best fit
- Built-in ProcAmp - color, hue, sharpness, noise, contrast and brightness
- Front panel control - audio mute, video blanking and freeze frame
- Built-in Web pages for easy setup and remote control
- Firmware upgrade via the Ethernet
- Non-Volatile memory that saves the final settings

Control your **VP-553**:

- Directly, via the front panel push buttons
- By RS-232 serial commands transmitted by a touch screen system, PC, or other serial controller
- Remotely, from the infrared remote control transmitter with OSD (on-screen display)
- Via the Ethernet with built-in Web pages

The **VP-553** is housed in a 19" 2U rack mountable enclosure, with rack "ears" included, and is fed from a 100-240 VAC universal switching power supply.

3.1 Using the USB Switcher

The **VP-553** incorporates a simple, yet effective, 4:1 USB 1.1 switcher. The switcher can be used, for example, to connect one out of several PCs to a smart board or other USB client.

The USB switcher can be routed as a separate layer, or can be tied to the video switching layer of the unit. This creates a powerful "USB follows video" system – the PC routed to the display also connects to the smart board. In many meeting room setups these USB switching schemes are highly effective.

3.2 Using Twisted Pair Cable for HDBT

Kramer engineers have developed special twisted pair cables to best match our digital twisted pair products; **BC-HDKat6a** (CAT 6 23 AWG cable) significantly outperforms regular CAT 5 / CAT 6 cables.



We strongly recommend that you use shielded twisted pair cable.

3.3 Shielded Twisted Pair (STP) / Unshielded Twisted Pair (UTP)

We recommend that you use Shielded Twisted Pair (STP) cable, and stress that the compliance to electromagnetic interference was tested using STP cable. There are different levels of STP cable available, and we advise you to use the best quality STP cable that you can afford. Our non-skew-free cable, Kramer **BC-STP** is intended for analog signals where skewing is not an issue.

In cases where there is skewing in analog TP systems, our Unshielded Twisted Pair (UTP) skew-free cable, Kramer **BC-XTP**, may be advantageous, and UTP cable might also be preferable for long range applications. In any event when using UTP cable, it is advisable to ensure that the cable is installed far away from electric cables, motors and so on, which are prone to create electrical interference.

3.4 Defining the VP-553 Presentation Switcher/Scaler

This section defines the **VP-553**.

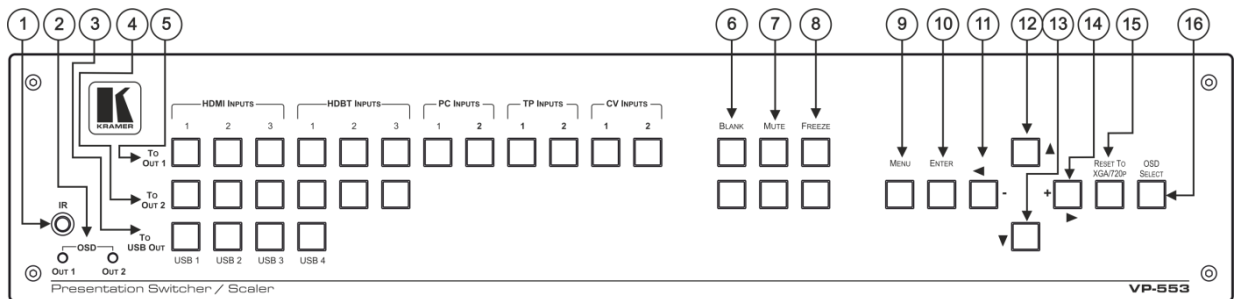

Figure 1: VP-553 Presentation Switcher/Scaler Front Panel

#	Feature	Function	
1	IR Receiver	Receives signals from the remote control transmitter	
2	OSD OUT LEDs	Red LEDs indicate whether the OSD is displayed on OUT 1 and/or OUT 2	
3	Input Selector Buttons	TO USB OUT	Press a button to switch a USB input to the output (from USB 1 to USB 4)
4		TO OUT 2	Press a button to switch an input to the OUT 2 output (HDMI inputs from 1 to 3 and HDBT inputs from 1 to 3)
5		TO OUT 1	Press a button to switch an input to the OUT 1 output (HDMI inputs from 1 to 3, HDBT inputs from 1 to 3, PC inputs from 1 to 2, TP inputs from 1 to 2 and CV inputs from 1 to 2)
6	BLANK Buttons	Press to toggle between a blank screen and the display on OUT 1 and OUT 2 separately; can be programmed to follow MUTE (see Section 6.2.5)	
7	MUTE Buttons	Press to toggle between muting (blocking out the sound) and enabling the embedded audio output for OUT 1 and OUT 2 separately Note that the mute button will not affect the LINE and MONITOR outputs	
8	FREEZE Buttons	Press to freeze/unfreeze the output video image on OUT 1 and OUT 2 separately; can be programmed to follow MUTE (see Section 6.2.5)	
9	MENU Button	Displays the OSD menu (see Section 6.2)	
10	ENTER Button	Press to accept changes and change the SETUP parameters (see Section 6.2)	
11	Navigation Buttons	◀/- Button	Press to decrease numerical values or select from several definitions When not within the OSD menu mode, press to reduce volume (for embedded HDMI inputs, this does not affect the embedded output)
12		▲ Button	Press to move up the menu list values (see Section 6.2)
13		▼ Button	Press to move down the menu list (see Section 6.2)
14		▶/+ Button	Press to increase numerical values or select from several definitions When not within the OSD menu mode, press to increase volume (for embedded HDMI inputs, this does not affect the embedded output)
15	RESET TO XGA/720p Button	Press to reset the video resolution of both scalers to XGA or 720p Press and hold for about 2 seconds to reset to XGA; or press and hold for about 5 seconds to reset to 720p	
16	OSD SELECT Button	Click to select the output on which the OSD will be displayed (on both outputs, on output 1, output 2 or none)	

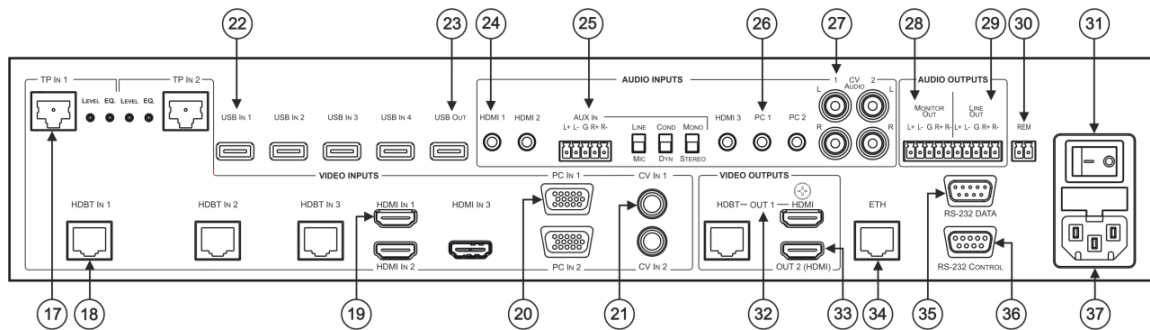

Figure 2: VP-553 Presentation Switcher/Scaler Rear Panel

#	Feature	Function		
17	VIDEO INPUT Connectors	TP IN	RJ-45	Connect to a TP transmitter, for example the TP-121xI (from 1 to 2)
		LEVEL Trimmer		Use to adjust the input signal level
		EQ. Trimmer		Use to adjust the cable compensation equalization level
18	HDBT IN	Connect to an HDBT Transmitter (for example, the Kramer TP-580Txr) to pass audio and video signals as well as serial commands (from 1 to 3)		
19	HDMI IN	Connect to the HDMI source (from 1 to 3)		
20	PC IN 15-pin HD	Connect to the computer graphics source (from 1 to 2)		
21	CV RCA	Connect to the composite video source (from 1 to 2)		
22	USB (A type) IN Connectors	Connect to a USB host (from 1 to 4)		
23	USB OUT (A type) Connector	Connect to a USB client		
24	AUDIO INPUT Connectors	HDMI 3.5mm Mini Jack	Connect to the analog audio HDMI source (from 1 to 3)	
		AUX IN	Terminal Block Connector	Connect to an auxiliary stereo balanced audio source or microphone
			LINE/MIC Selector	Select either a line or a microphone input
			COND/DYN Selector	Select between a condenser and a dynamic type microphone
26	PC 3.5mm Mini Jack	MONO/STEREO	Select between a stereo or mono input	
		PC 3.5mm Mini Jack	Connect to the analog audio computer graphics source (from 1 to 2)	
27	CV	Connect to the L and R analog audio composite video source (from 1 to 2)		

#	Feature		Function	
28	AUDIO OUTPUT	MONITOR OUT	Connect to a stereo analog audio acceptor (for example, active speakers or an audio power amplifier)	
29	Terminal Block Connectors	LINE OUT	Connect to a stereo analog audio acceptor (for example, active speakers or an audio power amplifier)	
30	REM Terminal Block Connector		Remote switch to mute the analog and embedded audio signal. Allows easy integration of the audio system with a public announcement audio system, usually used in cases of alarms or other audio messages	
31	POWER Switch		Switch for turning the unit ON or OFF	
32	VIDEO OUTPUT Connectors	OUT 1	HDMI	Connect to an HDMI acceptor
			HDBT RJ-45	Connect to an HDBT Receiver (for example, the Kramer TP-580Rxr)
33	OUT 2		Connect to an HDMI acceptor	
34	ETHERNET Connector		Connects to the PC or other Serial Controller through computer networking	
35	RS-232 DATA 9-pin D-sub Port		Connect to the PC or the remote controller and pass data between this RS-232 port and the HDBT OUT port or one of the HDBT IN ports	
36	RS-232 CONTROL 9-pin D-sub Port		Connect to the PC or the remote controller	
37	Power Connector with Fuse		AC connector, enabling power supply to the unit	

4 Installing in a Rack

This section provides instructions for rack mounting the unit.

Before installing in a rack, be sure that the environment is within the recommended range:

OPERATING TEMPERATURE:	0° to +40°C (32° to 104°F)
STORAGE TEMPERATURE:	-40° to +70°C (-40° to 158°F)
HUMIDITY:	10% to 90%, RHL non-condensing



CAUTION!

When installing on a 19" rack, avoid hazards by taking care that:

1. It is located within the recommended environmental conditions, as the operating ambient temperature of a closed or multi unit rack assembly may exceed the room ambient temperature.
2. Once rack mounted, enough air will still flow around the machine.
3. The machine is placed straight in the correct horizontal position.
4. You do not overload the circuit(s). When connecting the machine to the supply circuit, overloading the circuits might have a detrimental effect on overcurrent protection and supply wiring. Refer to the appropriate nameplate ratings for information. For example, for fuse replacement, see the value printed on the product label.
5. The machine is earthed (grounded) in a reliable way and is connected only to an electricity socket with grounding. Pay particular attention to situations where electricity is supplied indirectly (when the power cord is not plugged directly into the socket in the wall), for example, when using an extension cable or a power strip, and that you use only the power cord that is supplied with the machine.

To rack-mount a machine:

1. Attach both ear brackets to the machine. To do so, remove the screws from each side of the machine (5 on each side), and replace those screws through the ear brackets.

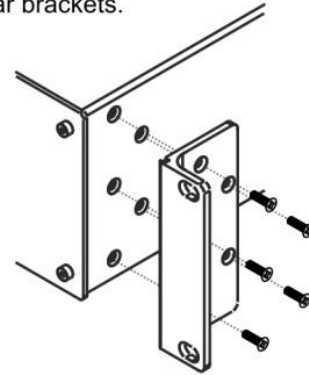

2. Place the ears of the machine against the rack rails, and insert the proper screws (not provided) through each of the four holes in the rack ears.

Note:

- In some models, the front panel may feature built-in rack ears
- Detachable rack ears can be removed for desktop use
- Always mount the machine in the rack before you attach any cables or connect the machine to the power
- If you are using a Kramer rack adapter kit (for a machine that is not 19"), see the Rack Adapters user manual for installation instructions available from our Web site

5 Connecting the VP-553



Always switch off the power to each device before connecting it to your **VP-553**. After connecting your **VP-553**, connect its power and then switch on the power to each device.



You do not have to connect all the inputs and outputs, connect only those that are required.

To connect the **VP-553**, as illustrated in the example in [Figure 3](#), do the following:

1. Connect an HDMI source (for example, a DVD player) to the HDMI VIDEO INPUT connector (from 1 to 3).
Alternatively, you can connect the DVI connector on the DVD player to the HDMI connector on the VP-553 via a DVI-HDMI adapter. When using this adapter, you can connect the audio signal via the terminal block connector
2. Connect a computer graphics source to the PC 1 15-pin HD VIDEO INPUT connector (from 1 to 2).
3. Connect a composite video source (for example, a composite video player) to the CV VIDEO INPUT RCA connector (from 1 to 2).
4. Connect a TP transmitter (for example, **TP-121xI**) to the RJ-45 TP IN connectors (from 1 to 2).
5. Connect an HDBT transmitter (for example, **TP-580T**) to the RJ-45 TP IN connectors (from 1 to 3).
6. Connect the USB IN ports (from 1 to 4) (for example, a PC) and USB OUT port (for example, a smart whiteboard).
7. Connect the audio inputs (not shown in [Figure 3](#)) to the:
 - HDMI audio input 3.5mm mini jacks (from 1 to 3)
 - PC audio input 3.5mm mini jacks (from 1 to 2)
 - CV audio inputs to the L and R RCA connectors (from 1 to 2)

8. Connect an external audio source to the AUX IN 5-pin terminal block connector (not shown in [Figure 3](#)).
9. Connect the video outputs. The:
 - OUT 1 HDMI and/or HDBT output to an HDMI acceptor (for example an LCD display) and/or an HDBT receiver (for example, the output of **TP-580R** connected to HDBT)
 - HDMI OUT 2 (for example, a projector)
10. Connect the LINE OUT and/or MONITOR OUT AUDIO OUTPUT terminal blocks to:
 - An audio power amplifier
 - Active speakers
11. Connect the:
 - RS-232 DATA 9-pin D-sub Port to a PC for sending RS-232 commands via HDBT
 - RS-232 CONTROL 9-pin D-sub Port to a PC to control the unit
12. Connect the REM 2-pin terminal block contact-closure remote-control pins to a switch to mute/unmute the audio output by momentarily pressing the switch.
13. Connect the ETHERNET port, see [Section 6.4](#)

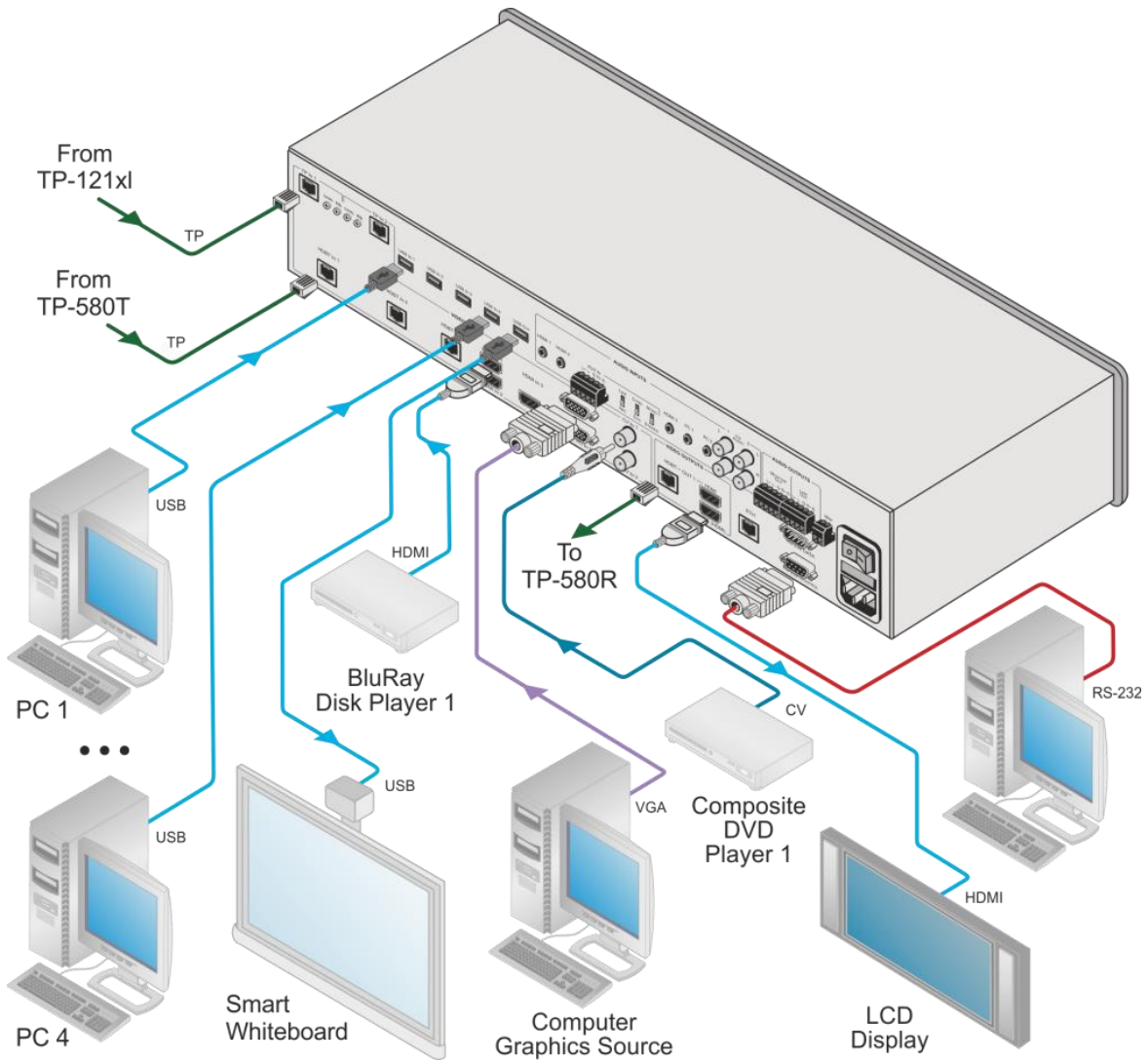

Figure 3: Connecting the VP-553 Presentation Switcher / Scaler

5.1 Connecting the Balanced Stereo Audio Input and Outputs

L+ L- G R+ R-

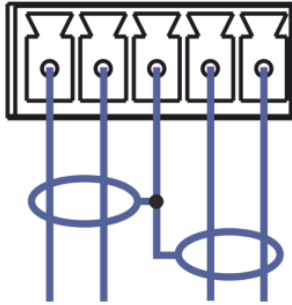

Figure 4: Balanced Stereo Audio Connection

L+ L- G R+ R-

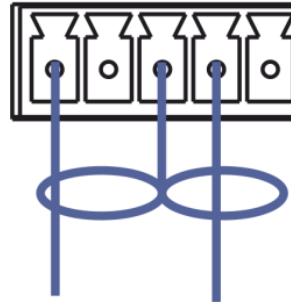

Figure 5: Unbalanced Stereo Audio Output Connection

AUX IN
L+ L- G R+ R-

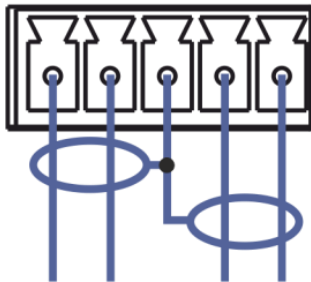

Figure 6: balanced Stereo Audio Input Connection

AUX IN
L+ L- G R+ R-

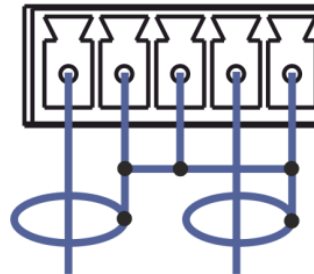

Figure 7: Unbalanced Stereo Audio Input Connection

6 Controlling the VP-553

The **VP-553** can be controlled via:

- The front panel buttons (see [Section 6.1](#))
- The OSD menu (see [Section 6.2](#))
- RS-232 serial commands transmitted by a touch screen system, PC, or other serial controller (see [Section 6.3](#))
- The ETHERNET (see [Section 6.4](#))
- The infrared remote control transmitter (see [Section 6.5](#))

6.1 Controlling via the Front Panel Buttons

The **VP-553** includes the following front panel buttons:

- Input selector buttons for selecting the required input: CV (1 and 2), TP (1 and 2), PC (1 and 2), HDBT (1 to 3), or HDMI (1 to 3) to OUT 1
- Input selector buttons for selecting the required input: HDBT (1 to 3), or HDMI (1 to 3) to OUT 2
- Input selector buttons for selecting the required USB port (1 to 4)
- BLANK, MUTE and FREEZE buttons (for OUT 1 and OUT 2)
- MENU, ENTER, and up, down, left and right arrow buttons
- RESET TO XGA/720p and OSD SELECT buttons

6.1.1 The Auto Adjust Feature

The auto adjust feature (applies only to the PC input) automatically centers the image on the screen when pressing the ENTER front panel button on the remote control transmitter (when not within the OSD menu).

You can also implement this feature every time the input is switched to VGA or when the input resolution changes, via the AUTO ADJUST menu (see [Section 6.2.2](#)).

6.2 Using the OSD Menu

The control buttons let you control the **VP-553** via the OSD menu. Press the:

- **MENU** button to enter the menu
The default timeout is set to 10 seconds
- **ENTER** button to accept changes and to change the menu settings
- **Arrow** buttons to move through the OSD menu, which is displayed on the video output

On the OSD menu, select **EXIT** to exit the menu.

6.2.1 The MAIN Menu

Mode	Function
OUTPUT 1	Set the output 1 parameters, see Section 6.2.2
OUTPUT 2	Set the output 2 parameters, see Section 6.2.3
AUDIO OUT	Set the audio output parameters, see Section 6.2.4
AUDIO SET	Set the audio input parameters, see Section 6.2.5
USB	Set the USB ports behavior, see Section 6.2.6
OSD	Set the OSD parameters: H POSITION, V POSITION, TIMER, BACKGROUND and DISPLAY, see Section 6.2.7
FACTORY	Select YES to reset to the default parameters. If you cannot see the display after factory reset, use the front panel RESET TO XGA/720p button to set the correct resolution: press to toggle between reset to XGA and reset to 720p
ETHER(NET)	IP MODE: Set to DHCP or STATIC. When selecting STATIC IP, the IP number appears next to IP ADDRESS SET STATIC IP: set the IP ADDRESS, DEF. GATEWAY (default gateway), and SUBNET MASK. CONTROL PORT: set the CONTROL PORT number
MISC.	You can use a remote control transmitter (that is used for controlling a peripheral device, for example, a DVD player) to send commands (to the A/V equipment) from/to any of the transmitters /receiver connected to the HDBT connectors (see Section 7.2.1). Select the IR transmission route for each of the units that are connected to the HDBT connectors (IN+OUT): HDBT1 (IR OUT): set to HDBT2, HDBT3 or HDBT OUT (to set the IR route from/to HDBT2, HDBT3 or HDBT OUT to HDBT1) HDBT2 (IR OUT): set to HDBT1, HDBT3 or HDBT OUT (to set the IR route from HDBT1, HDBT3 or HDBT OUT to HDBT2) HDBT3 (IR OUT): set to HDBT1, HDBT2 or HDBT OUT (to set the IR route from HDBT1, HDBT2 or HDBT OUT to HDBT3) HDBT OUT (IR OUT): set to HDBT1, HDBT2 or HDBT3 (to set the IR route from HDBT1, HDBT2 or HDBT3 to HDBT OUT) For example, set HDBT1 (IR OUT) to HDBT2 to control (via IR) the peripheral device that is connected to the device connected to HDBT 1 via the device connected to HDBT2, see Figure 25

Mode	Function
	<p>HDCP INPUT: select the HDCP option for each HDMI and HDBT input to either ON (the default) or OFF.</p> <p>Setting HDCP support to disabled (OFF) on the HDMI input allows the source to transmit a non-HDCP signal if required (for example, when working with a Mac computer)</p>
INFO.	<p>Displays the:</p> <p>OUTPUT 1 information – resolution, HDCP status and input source</p> <p>OUTPUT 2 information – resolution and input source</p> <p>DIP SWITCH: set MICHROPHONE, PHANTOM POWER, STEREO and MUTE CONTROL ON or OFF</p> <p>VERSION: shows the firmware version</p>

6.2.2 The OUTPUT 1 Menu

Mode	Function																																																				
SOURCE	<p>Select the source:</p> <table border="1"> <thead> <tr> <th>Source input</th> <th>Appears as:</th> <th>Source input</th> <th>Appears as:</th> </tr> </thead> <tbody> <tr> <td>HDMI 1</td> <td>HDMI1</td> <td>VGA 1</td> <td>PC1</td> </tr> <tr> <td>HDMI 2</td> <td>HDMI2</td> <td>VGA 2</td> <td>PC2</td> </tr> <tr> <td>HDMI 3</td> <td>HDMI3</td> <td>Twisted pair 1</td> <td>TP1</td> </tr> <tr> <td>HDBT 1</td> <td>HDBT1</td> <td>Twisted pair 2</td> <td>TP2</td> </tr> <tr> <td>HDBT 2</td> <td>HDBT2</td> <td>CV 1</td> <td>CV1</td> </tr> <tr> <td>HDBT 3</td> <td>HDBT3</td> <td>CV 2</td> <td>CV2</td> </tr> </tbody> </table>	Source input	Appears as:	Source input	Appears as:	HDMI 1	HDMI1	VGA 1	PC1	HDMI 2	HDMI2	VGA 2	PC2	HDMI 3	HDMI3	Twisted pair 1	TP1	HDBT 1	HDBT1	Twisted pair 2	TP2	HDBT 2	HDBT2	CV 1	CV1	HDBT 3	HDBT3	CV 2	CV2																								
Source input	Appears as:	Source input	Appears as:																																																		
HDMI 1	HDMI1	VGA 1	PC1																																																		
HDMI 2	HDMI2	VGA 2	PC2																																																		
HDMI 3	HDMI3	Twisted pair 1	TP1																																																		
HDBT 1	HDBT1	Twisted pair 2	TP2																																																		
HDBT 2	HDBT2	CV 1	CV1																																																		
HDBT 3	HDBT3	CV 2	CV2																																																		
PICTURE	<p>CONTRAST: Set the contrast (the range and default values vary according to the input signal)</p> <p>BRIGHTNESS: Set the brightness (the range and default values vary according to the input signal)</p> <p>COLOR: set the red (R), green (G) and blue (B) shades and offsets</p> <p>HUE: Set the color hue</p> <p>SATURATION: Set the color saturation</p> <p>SHARPNESS: Set the sharpness of the picture</p> <p>NR: Select the noise reduction: OFF, LOW, MIDDLE and HIGH</p>																																																				
SIZE	<p>Select the size of the display: FULL, OVER SCAN, UNDER1, UNDER2, LETTER BOX, PAN SCAN, BEST FIT (default, FULL)</p> <p>UNDER1 refers to an underscan of 6%; UNDER2 refers to an underscan of 9%</p>																																																				
RESOLUTION	<p>Select the output resolution from the menu (default NATIVE):</p> <table border="1"> <thead> <tr> <th>Output resolution:</th> <th>Appears as:</th> <th>Output resolution:</th> <th>Appears as:</th> </tr> </thead> <tbody> <tr> <td>Native</td> <td></td> <td>1600x1200</td> <td>1600x1200 60</td> </tr> <tr> <td>640x480</td> <td>640x480 60</td> <td>1920x1080</td> <td>1920x1080 60</td> </tr> <tr> <td>800x600</td> <td>800x600 60</td> <td>1920x1200</td> <td>1920x1200 60</td> </tr> <tr> <td>1024x768</td> <td>1024x768 60</td> <td>480p @60Hz</td> <td>720x480P 60</td> </tr> <tr> <td>1280x768</td> <td>1280x768 60</td> <td>720p @60Hz</td> <td>1280x720P 60</td> </tr> <tr> <td>1360x768</td> <td>1360x768 60</td> <td>1080i @60Hz</td> <td>1920x1080I 60</td> </tr> <tr> <td>1280x720</td> <td>1280x720 60</td> <td>1080p @60Hz</td> <td>1920x1080P 60</td> </tr> <tr> <td>1280x800</td> <td>1280x800 60</td> <td>576p @50Hz</td> <td>720x576P 60</td> </tr> <tr> <td>1280x1024</td> <td>1280x1024 60</td> <td>720p @50Hz</td> <td>1280x720P 50</td> </tr> <tr> <td>1440x900</td> <td>1440x900 60</td> <td>1080i @50Hz</td> <td>1920x1080I 50</td> </tr> <tr> <td>1400x1050</td> <td>1400x1050 60</td> <td>1080p @50Hz</td> <td>1920x1080P 50</td> </tr> <tr> <td>1680x1050</td> <td>1680x1050 60</td> <td></td> <td></td> </tr> </tbody> </table> <p>Native - Select Native to select the output resolution from the EDID of the connected HDMI monitor</p>	Output resolution:	Appears as:	Output resolution:	Appears as:	Native		1600x1200	1600x1200 60	640x480	640x480 60	1920x1080	1920x1080 60	800x600	800x600 60	1920x1200	1920x1200 60	1024x768	1024x768 60	480p @60Hz	720x480P 60	1280x768	1280x768 60	720p @60Hz	1280x720P 60	1360x768	1360x768 60	1080i @60Hz	1920x1080I 60	1280x720	1280x720 60	1080p @60Hz	1920x1080P 60	1280x800	1280x800 60	576p @50Hz	720x576P 60	1280x1024	1280x1024 60	720p @50Hz	1280x720P 50	1440x900	1440x900 60	1080i @50Hz	1920x1080I 50	1400x1050	1400x1050 60	1080p @50Hz	1920x1080P 50	1680x1050	1680x1050 60		
Output resolution:	Appears as:	Output resolution:	Appears as:																																																		
Native		1600x1200	1600x1200 60																																																		
640x480	640x480 60	1920x1080	1920x1080 60																																																		
800x600	800x600 60	1920x1200	1920x1200 60																																																		
1024x768	1024x768 60	480p @60Hz	720x480P 60																																																		
1280x768	1280x768 60	720p @60Hz	1280x720P 60																																																		
1360x768	1360x768 60	1080i @60Hz	1920x1080I 60																																																		
1280x720	1280x720 60	1080p @60Hz	1920x1080P 60																																																		
1280x800	1280x800 60	576p @50Hz	720x576P 60																																																		
1280x1024	1280x1024 60	720p @50Hz	1280x720P 50																																																		
1440x900	1440x900 60	1080i @50Hz	1920x1080I 50																																																		
1400x1050	1400x1050 60	1080p @50Hz	1920x1080P 50																																																		
1680x1050	1680x1050 60																																																				

Mode	Function	
OUTPUT HDCP	Select FOLLOW INPUT or FOLLOW OUTPUT to define whether the HDCP will follow the input or the output When FOLLOW INPUT is selected, it changes its HDCP output setting (for the HDMI output) according to the HDCP of the input. This option is recommended when the HDMI output is connected to a splitter/switcher When FOLLOW OUTPUT is selected, the scaler matches its HDCP output to the HDCP setting of the HDMI acceptor to which it is connected	
AUTOSYNC OFF	Turn the auto sync ON/OFF. When ON, this de-activates the output after a few minutes if no input is present. This is useful, for example, when the output is connected to a projector, and the projector will automatically shut down when it has no input	
AUDIO	Adjust audio parameters (see Section 6.2.2.1)	
AUDIO EQ	Set the audio EQ values in 0.5dB steps for: BELOW 120Hz, CENTER 200Hz, CENTER 500Hz, CENTER 1200Hz, CENTER 3000Hz, CENTER 7500Hz and ABOVE 12000Hz	
NO SIGNAL COLOR	Select a BLUE or BLACK window color if no signal is detected	
PC	AUTO ADJUST	When set to ON, auto adjusts the image (centers it correctly on the screen) every time the input is switched to VGA or when the input resolution changes
	H-POSITION	Set the horizontal position of the picture
	V-POSITION	Set the vertical position of the picture
	PHASE	Set the clock phase
	CLOCK	Set the clock frequency
	WXGA/XGA	Set to WXGA or XGA
	RESET	Reset settings to their default values

6.2.2.1 The AUDIO Parameters

Parameter	Function	
SOURCE	Select the audio source: FOLLOW VIDEO, HDMI1, HDMI2, HDMI3, HDBT1, HDBT2, HDBT3, PC1, PC2, TP1, TP2, CV1, CV2, or MIC	
EMBEDDED AUDIO	HDMI AUDIO IN (1, 2 and 3)	Select the HDMI 1, HDMI 2 and HDMI 3 audio sources behavior: AUTOMATIC: the embedded audio on the HDMI input is selected for an HDMI signal, or the analog audio input is selected if the input is not HDMI (for example, for a DVI input signal) EMBEDDED: the embedded audio in the HDMI signal is selected ANALOG: the analog audio input is selected HDMI AUDIO IN is enabled only when one of the HDMI inputs is selected
OUTPUT VOLUME	Set the output volume	
MUTE	Set MUTE to ON or OFF	
DELAY	Select the audio delay time: OFF, 10ms to 80ms in 10ms steps or DYNAMIC	
MICROPHONE MIX	Set mix ON to mix the microphone input with the selected audio input or set to OFF	
MIX LEVEL	Adjust the mix level (enabled when MICROPHONE MIX is set to ON)	

6.2.3 The OUTPUT 2 Menu

Mode	Function			
SOURCE	Select the source:			
	Source input	Appears as:	Source input	Appears as:
	HDMI 1	HDMI1	HDBT 1	HDBT1
	HDMI 2	HDMI2	HDBT 2	HDBT2
	HDMI 3	HDMI3	HDBT 3	HDBT3
PICTURE	<p>CONTRAST: Set the contrast (the range and default values vary according to the input signal)</p> <p>BRIGHTNESS: Set the brightness (the range and default values vary according to the input signal)</p> <p>COLOR: set the red (R), green (G) and blue (B) shades and offsets</p> <p>HUE: Set the color hue</p> <p>SATURATION: Set the color saturation</p> <p>SHARPNESS: Set the sharpness of the picture</p> <p>NR: Select the noise reduction: OFF, LOW, MIDDLE and HIGH</p>			
SIZE	<p>Select the size of the display: FULL, OVERS CAN, UNDER1, UNDER2, LETTER BOX, PANS CAN, BEST FIT (default, FULL)</p> <p>UNDER1 refers to an underscan of 6%; UNDER2 refers to an underscan of 9%</p>			
RESOLUTION	Select the output resolution from the menu (default NATIVE):			
	Output resolution:	Appears as:	Output resolution:	Appears as:
	Native		1600x1200	1600x1200 60
	640x480	640x480 60	1920x1080	1920x1080 60
	800x600	800x600 60	1920x1200	1920x1200 60
	1024x768	1024x768 60	480p @60Hz	720x480P 60
	1280x768	1280x768 60	720p @60Hz	1280x720P 60
	1360x768	1360x768 60	1080i @60Hz	1920x1080I 60
	1280x720	1280x720 60	1080p @60Hz	1920x1080P 60
	1280x800	1280x800 60	576p @50Hz	720x576P 60
	1280x1024	1280x1024 60	720p @50Hz	1280x720P 50
	1440x900	1440x900 60	1080i @50Hz	1920x1080I 50
	1400x1050	1400x1050 60	1080p @50Hz	1920x1080P 50
	1680x1050	1680x1050 60		
	Native - Select Native to select the output resolution from the EDID of the connected HDMI monitor			
OUTPUT HDCP	<p>Select FOLLOW INPUT or FOLLOW OUTPUT to define whether the HDCP will follow the input or the output</p> <p>When FOLLOW INPUT is selected, it changes its HDCP output setting (for the HDMI output) according to the HDCP of the input. This option is recommended when the HDMI output is connected to a splitter/switcher</p> <p>When FOLLOW OUTPUT is selected, the scaler matches its HDCP output to the HDCP setting of the HDMI acceptor to which it is connected</p>			
AUTOSYNC OFF	<p>Turn the auto sync ON/OFF. When ON, this de-activates the output after a few minutes if no input is present.</p> <p>This is useful, for example, when the output is connected to a projector, and the projector will automatically shut down when it has no input</p>			
AUDIO	Adjust audio parameters (see Section 6.2.3.1)			
AUDIO EQ	Set the audio EQ values in 0.5dB steps for: BELOW 120Hz, CENTER 200Hz, CENTER 500Hz, CENTER 1200Hz, CENTER 3000Hz, CENTER 7500Hz and ABOVE 12000Hz			
NO SIGNAL COLOR	Select a BLUE or BLACK window color if no signal is detected			

6.2.3.1 The AUDIO Parameters

Parameter	Function	
SOURCE	Select the audio source: FOLLOW VIDEO, HDMI1, HDMI2, HDMI3, HDBT1, HDBT2, HDBT3, PC1, PC2, TP1, TP2, CV1, CV2, or MIC	
EMBEDDED AUDIO	HDMI AUDIO IN (1, 2 and 3)	Select the HDMI 1, HDMI 2 and HDMI 3 audio sources behavior: AUTOMATIC: the embedded audio on the HDMI input is selected for an HDMI signal, or the analog audio input is selected if the input is not HDMI (for example, for a DVI input signal) EMBEDDED: the embedded audio in the HDMI signal is selected ANALOG: the analog audio input is selected HDMI AUDIO IN is enabled only when one of the HDMI inputs is selected
OUTPUT VOLUME	Set the output volume	
MUTE	Set MUTE to ON or OFF	
DELAY	Select the audio delay time: OFF, 10ms to 80ms in 10ms steps or DYNAMIC	
MICROPHONE MIX	Set mix ON to mix the microphone input with the selected audio input or set to OFF	
MIX LEVEL	Adjust the mix level (enabled when MICROPHONE MIX is set to ON)	

6.2.4 The AUD OUT Menu

Parameter	Function	
SOURCE	Select the audio source: HDMI1, HDMI2, HDMI3, HDBT1, HDBT2, HDBT3, PC1, PC2, TP1, TP2, CV1, CV2 or AUX	
EMBEDDED AUDIO	HDMI AUDIO IN (1, 2 and 3)	Select the HDMI 1, HDMI 2 and HDMI 3 audio sources behavior: AUTOMATIC: the embedded audio on the HDMI input is selected for an HDMI signal, or the analog audio input is selected if the input is not HDMI (for example, for a DVI input signal) EMBEDDED: the embedded audio in the HDMI signal is selected ANALOG: the analog audio input is selected HDMI AUDIO IN is enabled only when one of the HDMI inputs is selected
OUTPUT VOLUME	LINE	Set the LINE OUT volume
	MONITOR	Set the MONITOR OUT volume
LINE OUT MUTE	Set to ON or OFF	
MONITOR OUT MUTE	Set to ON or OFF	
DELAY	Select the audio delay time: OFF, 10 to 80ms in 10ms steps or DYNAMIC	
MICROPHONE MIX	Set to ON or OFF Set to ON to mix the microphone input with the selected audio input or set to OFF	
MIX LEVEL	Adjust the mix level	
EQ SAME AS	Set to NONE, OUTPUT 1 or OUTPUT 2	
AUDIO EQ	Set the audio EQ values in 0.5dB steps for: BELOW 120Hz, CENTER 200Hz, CENTER 500Hz, CENTER 1200Hz, CENTER 3000Hz, CENTER 7500Hz and ABOVE 12000Hz	

6.2.5 The AUD SET Menu

Parameter	Function
MICROPHONE GAIN	Set the microphone gain
INPUT VOLUME	Set the volume for each input: HDMI1 (embedded), HDMI2 (embedded), HDMI3 (embedded) HDBaseT1 (embedded), HDBaseT2 (embedded), HDBaseT3 (embedded), HDMI1 (analog), HDMI2 (analog), HDMI3 (analog), PC1, PC2. TP1, TP2, CV1, CV2
MUTE FOLLOWS	Select the action that will be followed by mute: NONE : the audio muting is independent of the FREEZE and BLANK functions FREEZE BLANK FREEZE+BLANK : when freezing or blanking the video, the audio will be muted (the MUTE function follows the FREEZE and the BLANK functions)

6.2.6 The USB Menu

Parameter	Function
SOURCE	Select the USB input: USB 1, USB 2, USB 3, USB 4 or TIE TO INPUT.
SETUP FOLLOW INPUT	If TIE TO INPUT was selected above, setup the input to which the selected USB port will be tied. For each of the inputs you can select a USB port that will follow. For example, if you want to set USB 3 to follow HDMI 3, select HDMI 3 and set to USB 3

6.2.7 The OSD Menu

Parameter	Function
SHOW ON OUTPUT	Select the output/s that will display the OSD: BOTH ON, BOTH OFF, OUTPUT 1 or OUTPUT 2
H POSITION	Set the horizontal position of the OSD
V POSITION	Set the vertical position of the OSD
TIMER	Set the timeout period in 5sec steps (from 5 to 60) or set to OFF
TRANSPARENCY	Set the OSD background between 0 (transparent) and 50 (opaque)
DISPLAY	Select the information shown on the screen during operation: OFF : the information is not shown ON : the information is shown permanently INFO : the information is shown for a few seconds

6.3 Connecting to the VP-553 via RS-232

The **VP-553** features two RS-232 ports:

- RS-232 DATA to pass data to and from the machines that are connected to the HDBT connectors
- RS-232 CONTROL to control the **VP-553**

You can connect to the **VP-553** via an RS-232 connection using, for example, a PC. Note that a null-modem adapter/connection is not required.

To connect to the **VP-553** via RS-232 Connect the RS-232 9-pin D-sub rear panel port on the product unit via a 9-wire straight cable (only pin 2 to pin 2, pin 3 to pin 3, and pin 5 to pin 5 need to be connected) to the RS-232 9-pin D-sub port on your PC.

6.4 Operating via Ethernet

You can connect to the **VP-553** via Ethernet using either of the following methods:

- Directly to the PC using a crossover cable (see [Section 6.4.1](#))
- Via a network hub, switch, or router, using a straight-through cable (see [Section 6.4.2](#))

Note: If you want to connect via a router and your IT system is based on IPv6, speak to your IT department for specific installation instructions.

6.4.1 Connecting the Ethernet Port Directly to a PC

You can connect the Ethernet port of the **VP-553** directly to the Ethernet port on your PC using a crossover cable with RJ-45 connectors.



This type of connection is recommended for identifying the **VP-553** with the factory configured default IP address.

After connecting the **VP-553** to the Ethernet port, configure your PC as follows:

1. Click **Start > Control Panel > Network and Sharing Center**.
2. Click **Change Adapter Settings**.
3. Highlight the network adapter you want to use to connect to the device and click **Change settings of this connection**.

The Local Area Connection Properties window for the selected network adapter appears as shown in [Figure 8](#).

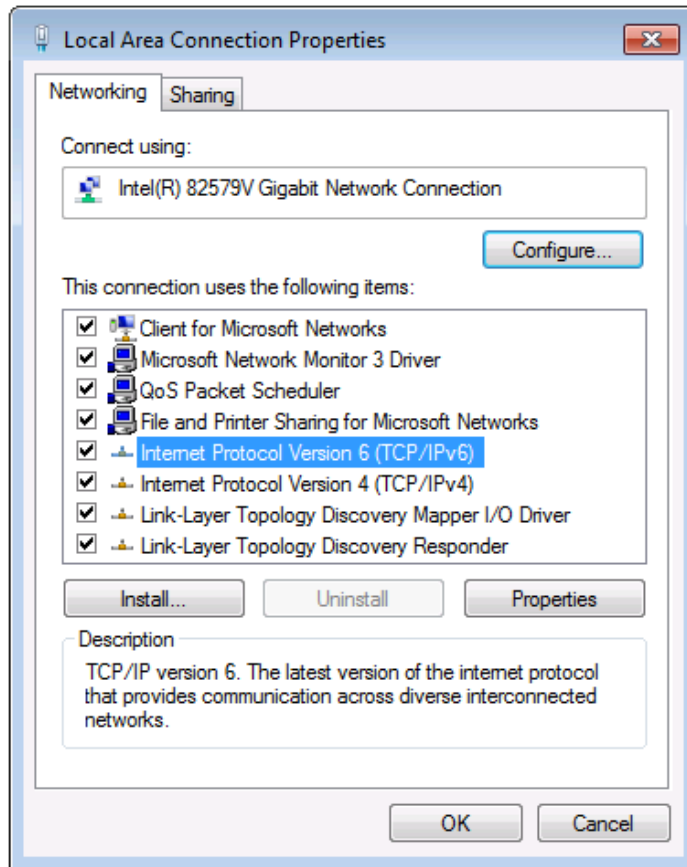

Figure 8: Local Area Connection Properties Window

4. Highlight either **Internet Protocol Version 6 (TCP/IPv6)** or **Internet Protocol Version 4 (TCP/IPv4)** depending on the requirements of your IT system.
5. Click **Properties**.
The Internet Protocol Properties window relevant to your IT system appears as shown in [Figure 9](#) or [Figure 10](#).

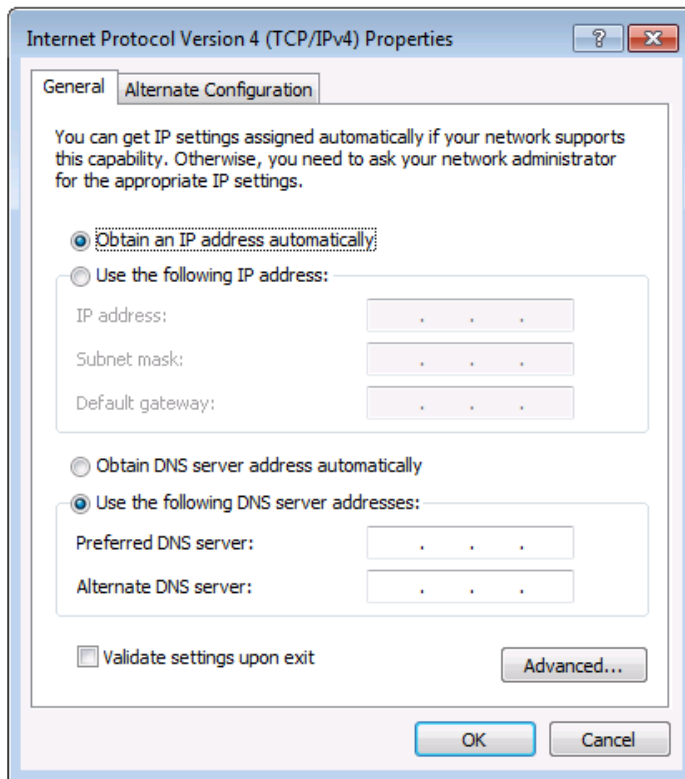

Figure 9: Internet Protocol Version 4 Properties Window

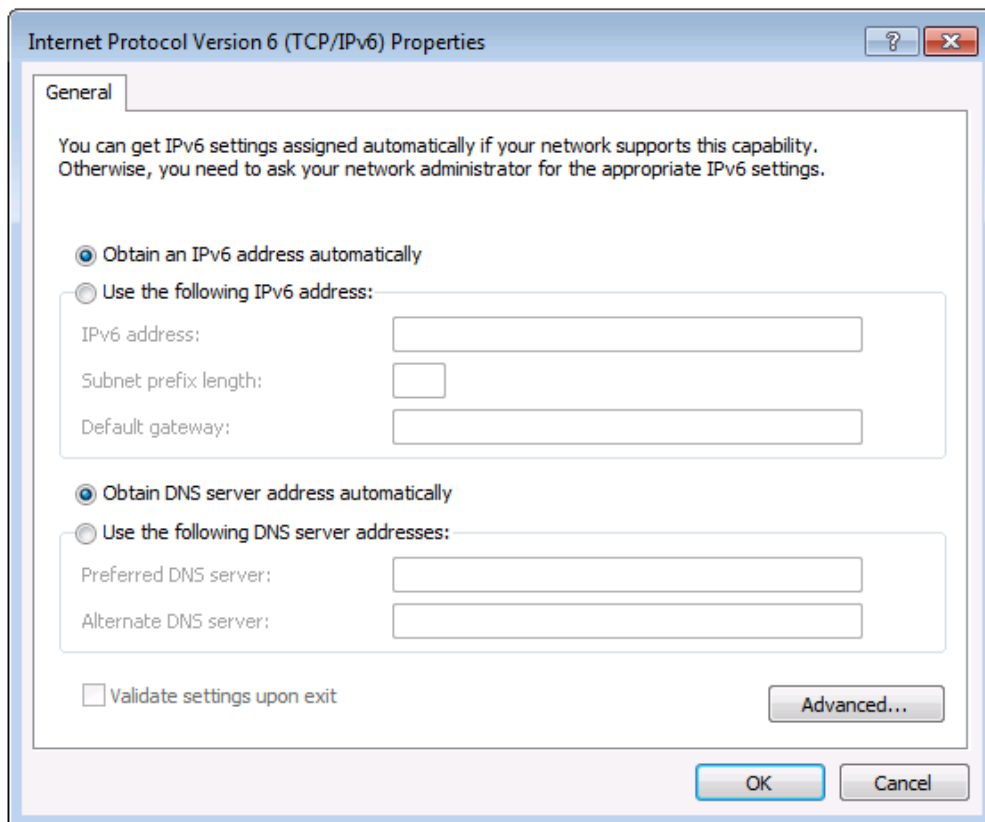

Figure 10: Internet Protocol Version 6 Properties Window

6. Select **Use the following IP Address** for static IP addressing and fill in the details as shown in [Figure 11](#).

For TCP/IPv4 you can use any IP address in the range 192.168.1.1 to 192.168.1.255 (excluding 192.168.1.39) that is provided by your IT department.

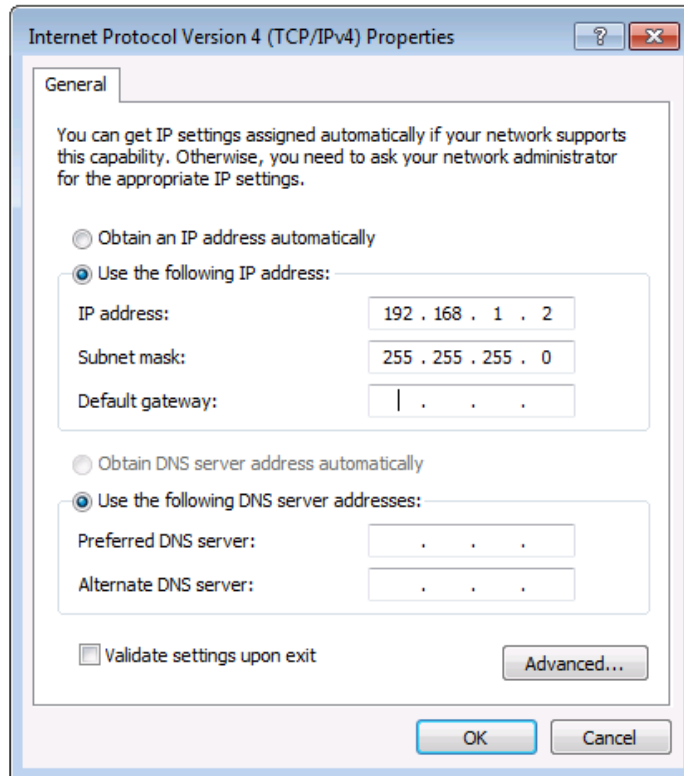

Figure 11: Internet Protocol Properties Window

7. Click **OK**.
8. Click **Close**.

6.4.2 Connecting the Ethernet Port via a Network Hub or Switch

You can connect the Ethernet port of the **VP-553** to the Ethernet port on a network hub or using a straight-through cable with RJ-45 connectors.

6.4.3 Control Configuration via the Ethernet Port

To control several units via Ethernet, connect the Master unit (Device 1) via the Ethernet port to the Ethernet port of your PC. Use the OSD menu to provide initial configuration of the settings (see [Section 6.2.1](#)).

6.5 Controlling via the Infrared Remote Control Transmitter

You can control the **VP-553** from the infrared remote control transmitter:



Figure 12: Infrared Remote Control Transmitter

Keys		Function
POWER		Toggle the power save mode ON or OFF
OUT 1	BLANK	Toggle between a blank screen black screen and the display (for both windows)
	MUTE	Toggle between muting (blocking out the sound) and enabling the audio output
	FREEZE	Freeze/unfreeze the output video image (for both windows)
OUT 2	BLANK	Toggle between a blank screen black screen and the display (for both windows)
	MUTE	Toggle between muting (blocking out the sound) and enabling the audio output
	FREEZE	Freeze/unfreeze the output video image (for both windows)
		Press ENTER to access menu levels (when in the OSD) Use the up and down arrows to adjust numerical values and adjust the output volume level (when not within the OSD)
MENU		Enter/Exit the OSD menu and return to the previous menu level
OSD		Select whether the OSD will appear on OUT 1, OUT 2, both or none of them
720p/XGA		Press to reset to the default resolution (toggles between XGA and 720p)
USB		Select a USB input: 1, 2, 3 or 4
OUT 1		Select one of the following inputs to switch to output 1: HDMI 1, HDMI 2, HDMI 3, HDBT 1, HDBT 2, HDBT 3, PC 1, PC 2, TP 1, TP 2, CV 1 or CV 2
OUT 2		Select one of the following inputs to switch to output 2: HDMI 1, HDMI 2, HDMI 3, HDBT 1, HDBT 2 or HDBT 3

7 Using the Embedded Web Pages

The **VP-553** can be operated remotely using the embedded Web pages. The Web pages are accessed using a Web browser and an Ethernet connection.

Before attempting to connect:

- Perform the procedures in [Section 6.4](#).
- Ensure that your browser is supported

The following operating systems and Web browsers are supported:

Windows 7:

- Chrome version 35
- Firefox version 30
- Internet Explorer version 10

Mac (PC):

- Chrome version 35
- Firefox version 27

Android OS:

- Chrome version 35

iOS:

- Chrome version 35
- Safari (depends on the IOS version)

7.1 Browsing the VP-553 Web Pages

To browse the VP-553 Web pages:

1. Open your Internet browser.
2. Type the IP number of the device in the Address bar of your browser. For example, the default IP number:



The Loading page appears.

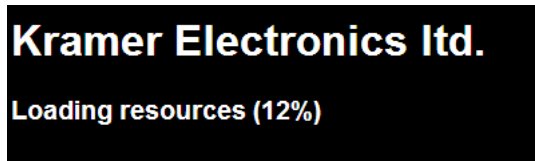

Figure 13: The Loading Page

Once loaded, enter your user name and password:

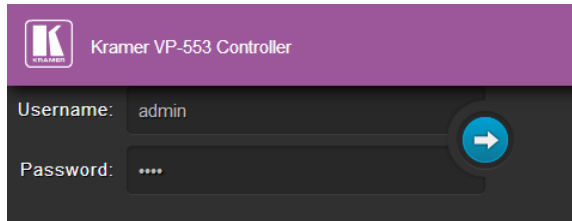

Figure 14: Enter Username and Password

There are eight Web pages:

- The Switching page (see [Section 7.2](#))
- The Scaler page (see [Section 7.3](#))
- The Device Settings page (See [Section 7.4](#))
- The USB Routing page (see [Section 7.5](#))
- The Audio Settings page (see [Section 7.6](#))
- The EDID page (see [Section 7.7](#))
- The Authentication page (see [Section 7.8](#))
- The About page (see [Section 7.10](#))

7.2 The Switching Page

[Figure 12](#) shows the Switching page that is also the first page that appears following the loading page. The column on the left shows the switching page selected and below a list of all the other available Web pages. The Switching area lets you switch an input to an output (audio, video or audio-follow-video) the Audio out (below Output) shows the audio input that is routed to the line and monitor outputs. The volume area lets you control the Line and Monitor output audio level.

The lower part of the screen lets you save the settings and upload a saved setting. The model name, FW version and IP number appear on the lower left side of the main page.

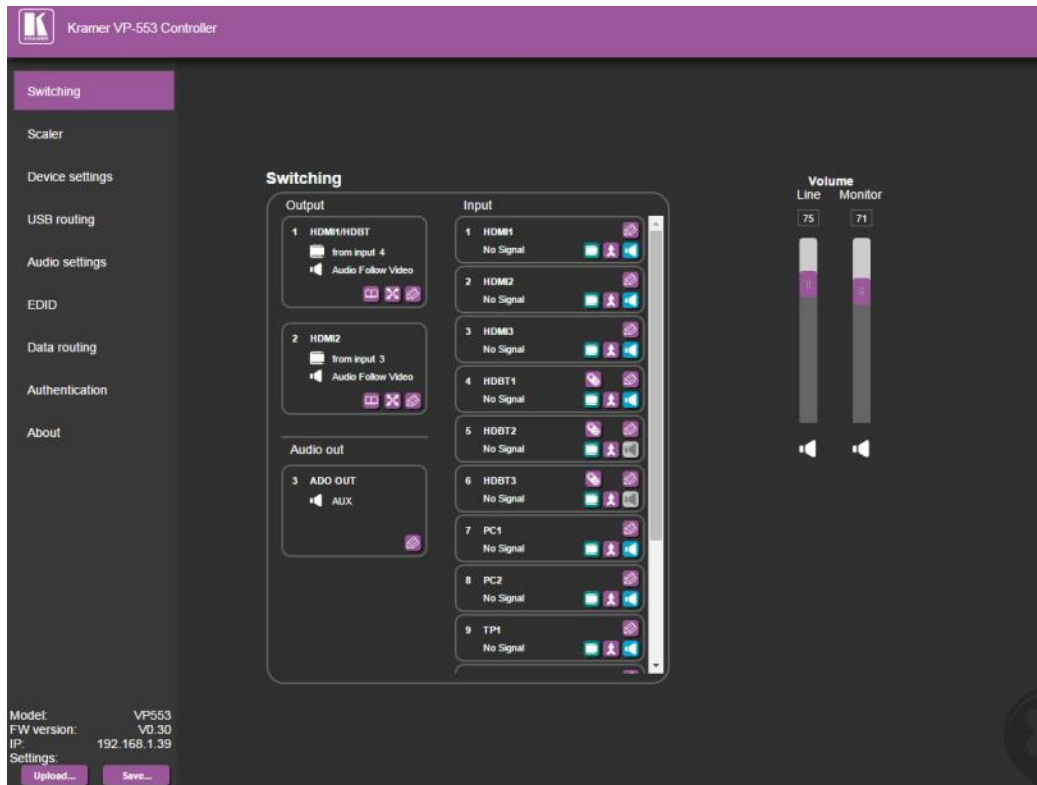

Figure 15: The Switching Page

[Figure 16](#) explains the icons used to switch inputs and outputs.

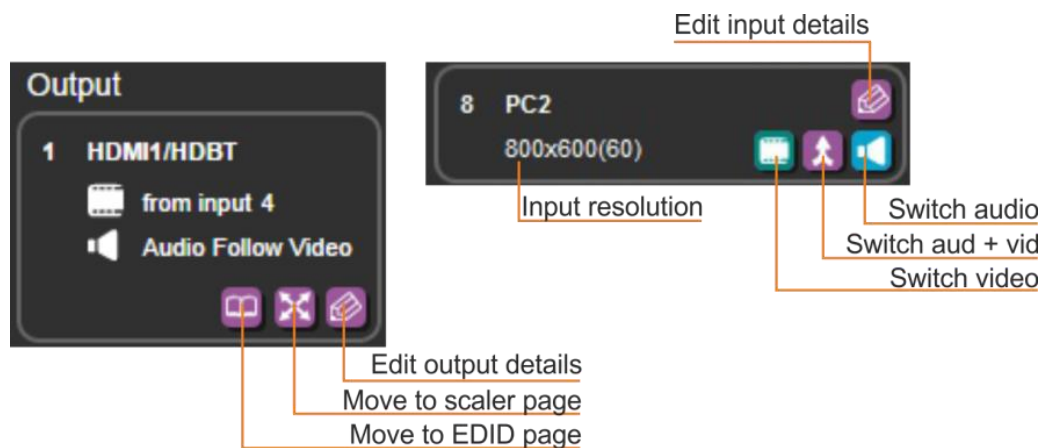

Figure 16: Switching Page – Input and Output Icons

You can also edit the input and output button by clicking the edit icon.

To edit an output button, select that button and click the edit icon. The output edit window appears:

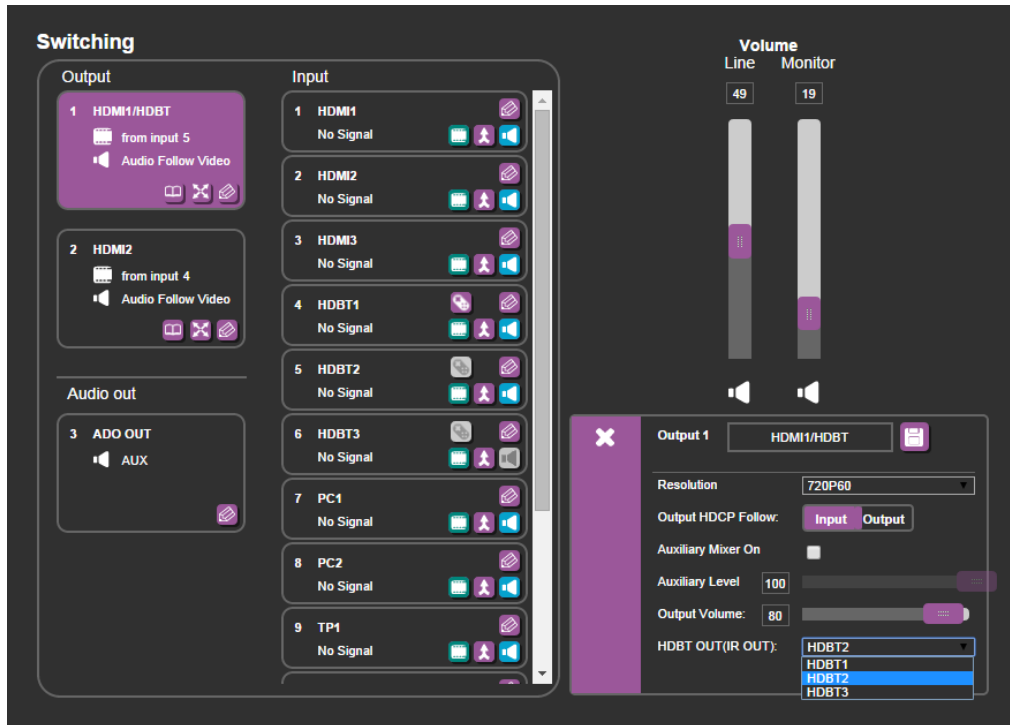

Figure 17: Edit Output Buttons

The OUT 1 edit window lets you change the name of the output as it will appear on the Web page and save it, set the resolution, the HDCP settings, the Auxiliary mixer ON or OFF and set the Auxiliary level as well as the output volume and the IR transmission route to the HDBT output (see [Section 7.2.1](#)).

OUT 2 does not include the IR routing selection line:

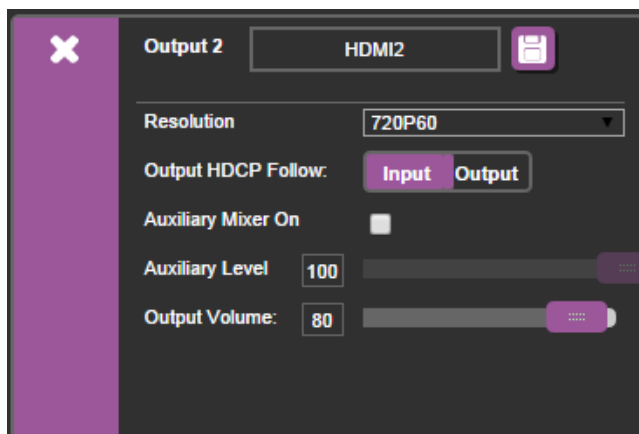

Figure 18: Edit Output Buttons

To edit an input button, select that button and click the edit icon. The input edit window appears:

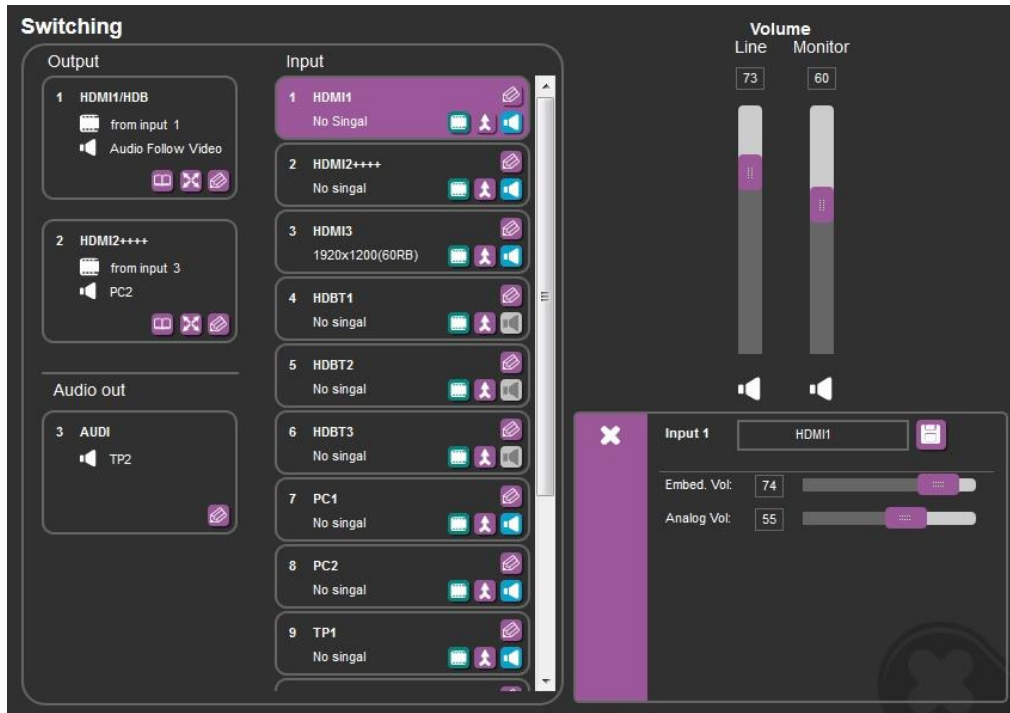

Figure 19: Edit Input Buttons

The input edit window lets you change the name of the input as it will appear on the Web page and save it, and also set the embedded and analog volume separately.

The input details editing window (see [Figure 16](#)) is slightly different for each input type.

When selecting an HDMI input you can rename the input, set the embedded and analog audio volume and set HDCP to ON or OFF:

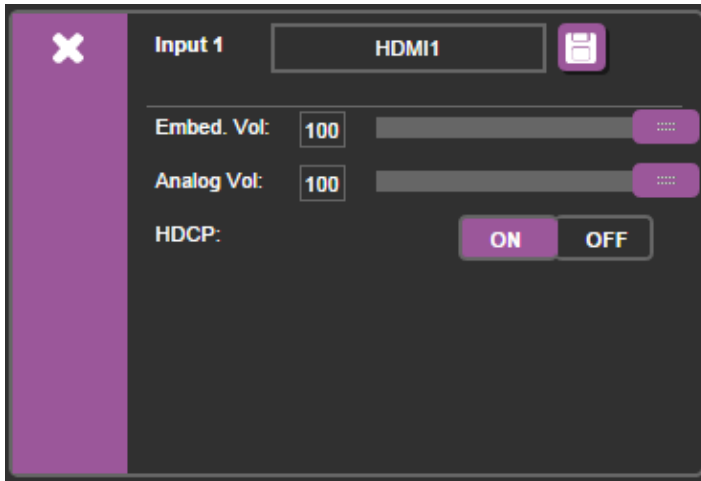

Figure 20: Switching Page – HDMI input Window

When selecting the HDBT input, you can rename the input, set the embedded audio volume, set the HDCP to ON or OFF, and set the HDBT IR OUT signal route (see [Section 7.2.1](#)):

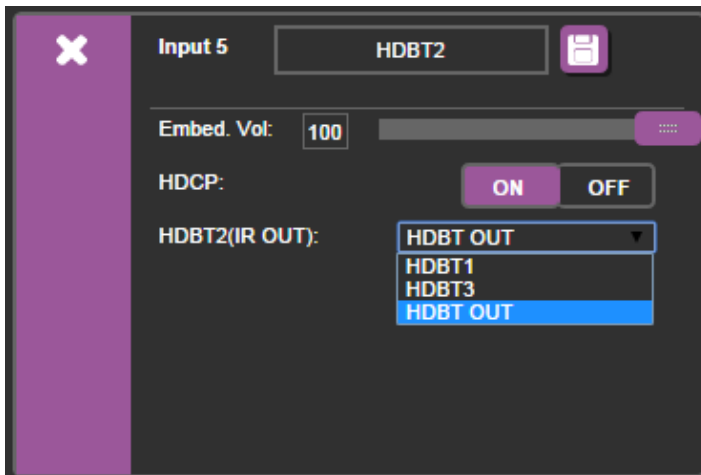

Figure 21: Switching Page – HDBT input Window

For HDBT inputs, when a Kramer **SID-X2N** unit is connected to the HDBT input, click the **SID-X2N** icon (see [Figure 22](#)) to open the **SID-X2N** setup window (see [Figure 23](#)).

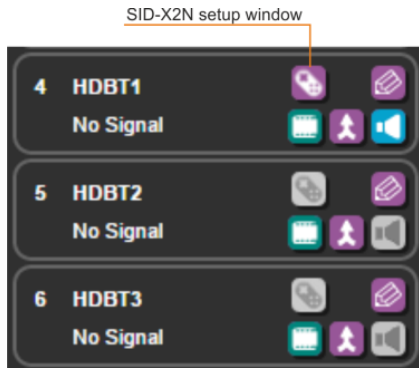

Figure 22: Switching Page – SID-X2N Setup Icon

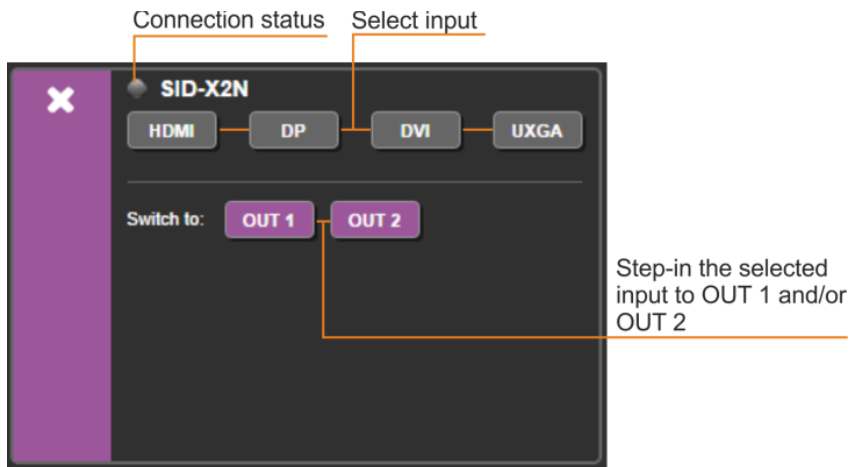

Figure 23: Switching Page – SID-X2N Setup Window

The connection status indicator appears gray if the device is not connected, red if it is connected but without a valid signal and green if a signal is routed to the output.

When connecting a PC or TP or CV input, you can rename the input and set the analog audio:

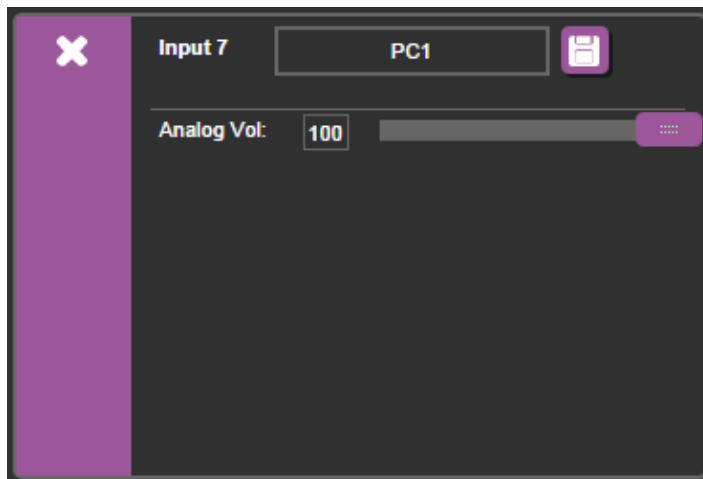

Figure 24: Switching Page – PC, TP or CV input Window

7.2.1 Setting the IR Transmission Route

IR can be routed from any of the HDBT ports to one or more of the other HDBT ports.

For example, Output 1, when used with its HDBT connector (not the HDMI) can be used as an IR output as well, defining the IR input via the drop down menu.

[Figure 25](#) shows the IR signal route when setting HDBT 1 (IR OUT) to HDBT 2. In this example, an External IR Sensor is connected to the IR connector of the **TP-580T** (connected to HDBT 2) and an IR Emitter is connected between the **TP-580T** (connected to HDBT 1) and a DVD player. The DVD remote control sends a command while pointing towards the External IR Sensor. The IR signal passes through the TP cables, the **VP-553** and the IR Emitter to the DVD player, which responds to the command sent. At the same time you can also set HDBT 3 to HDBT 1, thus sending IR commands from HDBT also to HDBT 3 (see blue line in [Figure 25](#)). This will work only if the devices are set appropriately.

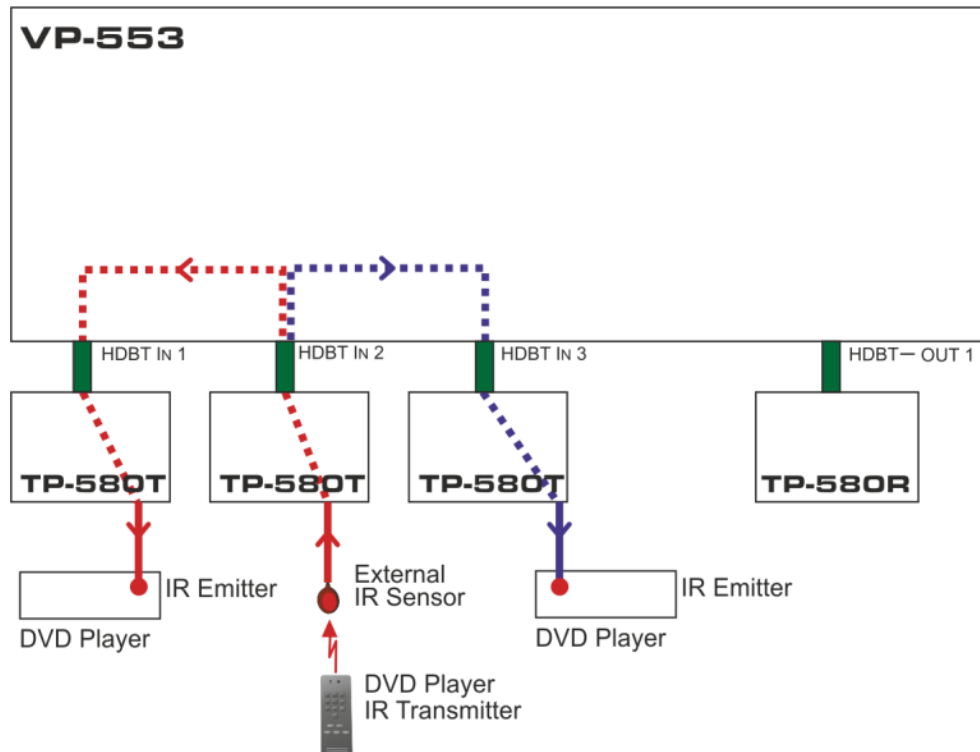



Figure 25: HDBT IR transmission Example



7.2.2 Switching an Input to an Output

You can switch the input audio and video signals together to a selected output (AFV) or separately.

To switch an Input to an Output in the AFV mode (see the output 1 button in [Figure 19](#)):

1. Click an output button.
The button changes color to purple.
2. Click on the Input AFV icon .
The Output shows the video input next to the video icon and Audio Follow Video next to its audio icon.

To switch separate audio and video inputs to an output (for example, selecting the video from INPUT 3 and the PC2 audio signal from INPUT 8, see the output 2 button in [Figure 19](#)):

1. Click an output button.
The button changes color to purple.
2. Click the video icon  on Input 3.
The output 2 button displays **from input 3** next to the video icon.
3. Click the audio icon  on Input 8.
The Output 2 button displays **PC2** next to the audio icon.

7.3 The Scaler Page

The Scaler page lets you set the output 1 and output 2 picture and PC mode separately.

[Figure 26](#) shows the Scaler page for output 1 which includes the picture setup and the PC mode setup.



Note that when the PC inputs are connected all the settings are available. If TP is selected, only the WXGA/XGA is enabled otherwise, PC mode is disabled.



Figure 26: The Scaler Page – Output 1

When an analog input is connected, the PC mode is enabled:

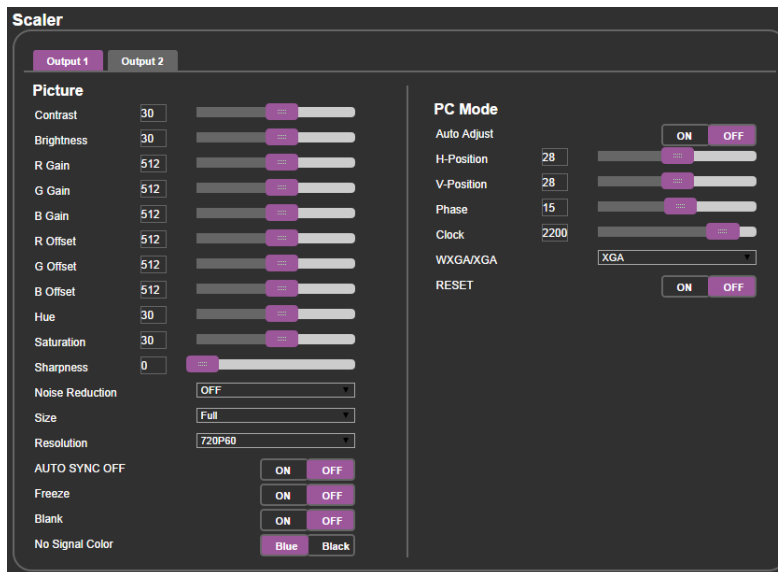

Figure 27: The Scaler Page – Output 1 for an Analog Input

[Figure 28](#) shows the setup for output 2:

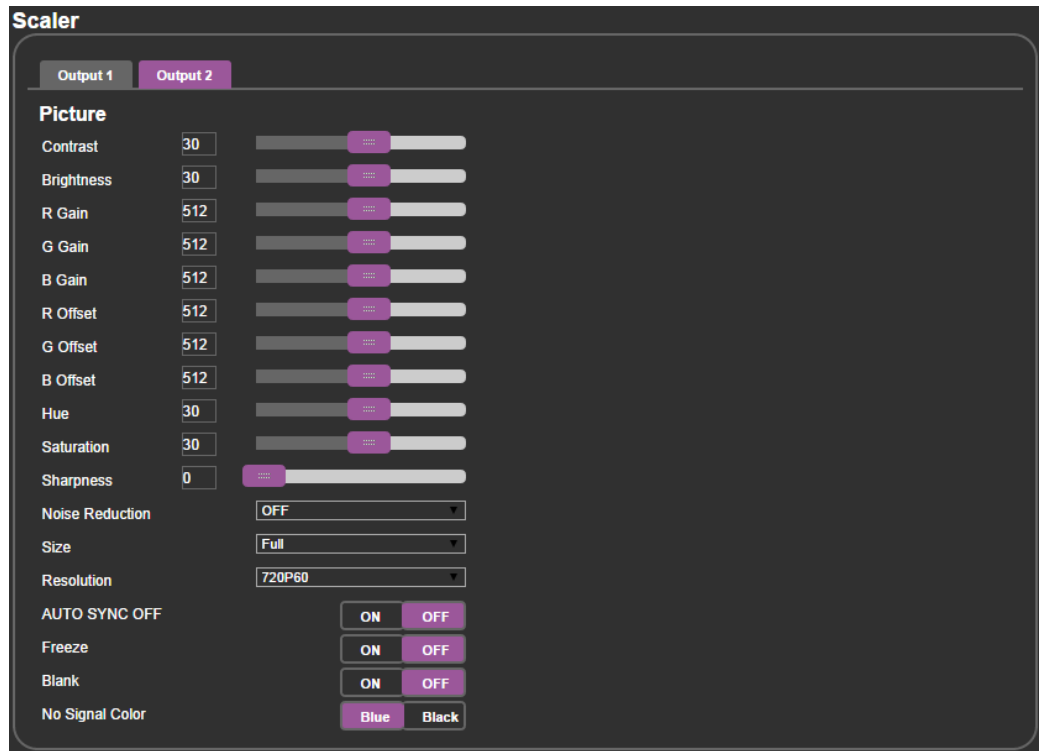
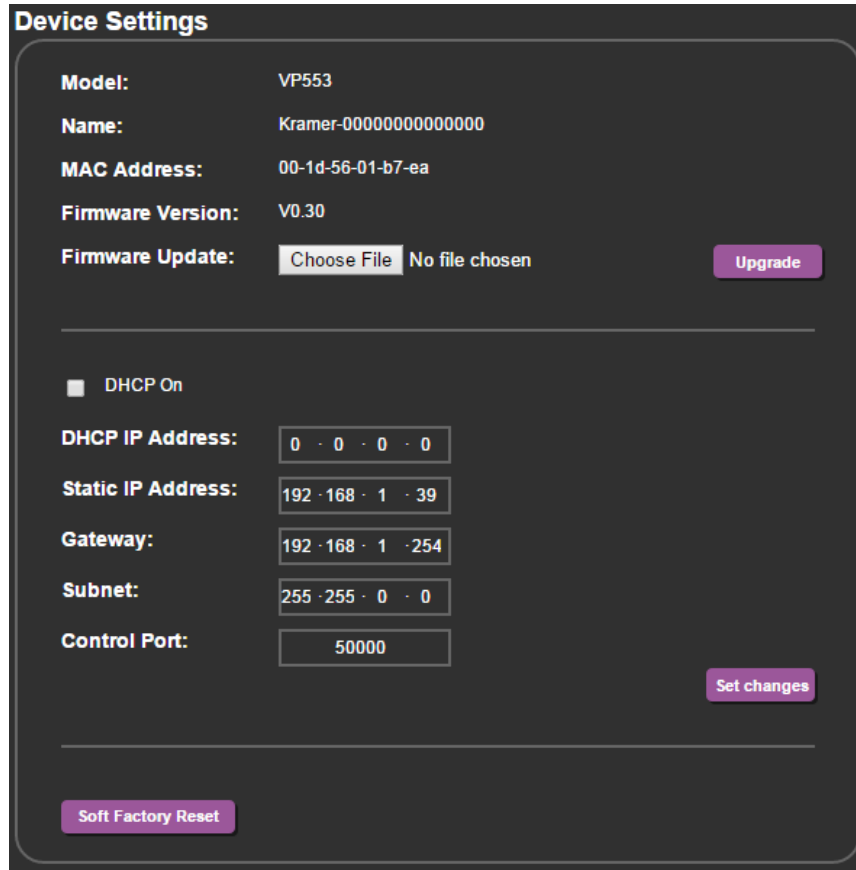

Figure 28: The Scaler Page – Output 2

7.4 The Device Settings Page

The device Settings window (in [Figure 29](#)) lets you upgrade the firmware and set the Ethernet parameters.



Device Settings

Model: VP553
Name: Kramer-0000000000000000
MAC Address: 00-1d-56-01-b7-**ea**
Firmware Version: V0.30
Firmware Update: No file chosen

DHCP On

DHCP IP Address:
Static IP Address:
Gateway:
Subnet:
Control Port:

Figure 29: The Device Settings Page

Any change in the device settings requires confirmation, as illustrated in the example in [Figure 30](#).



Are You Sure You Want To Change Static IP Setting?

Figure 30: The Device Settings Page – Static IP Confirmation

7.4.1 Firmware Upgrade

You can upgrade the firmware via the Device Settings page. To do so:

1. Choose the firmware file by clicking the Choose File button in the Firmware upgrade line.
2. Click the Upgrade button.

The new firmware is uploaded:

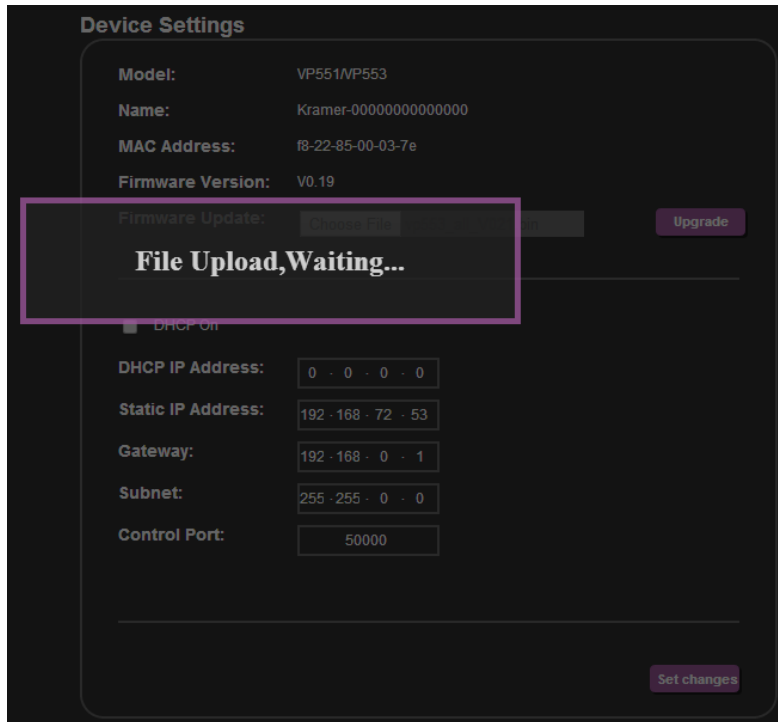

Figure 31: The Device Settings Page – Uploading the New Firmware File

3. Make sure that the new version appears on the Web page lower left side:

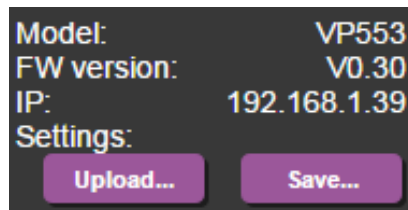

Figure 32: The Device Settings Page – New Firmware Updated

7.4.2 Soft Factory Reset

Click the Soft Factory Reset button to reset all the device parameters except for the IP Address. The following message appears:

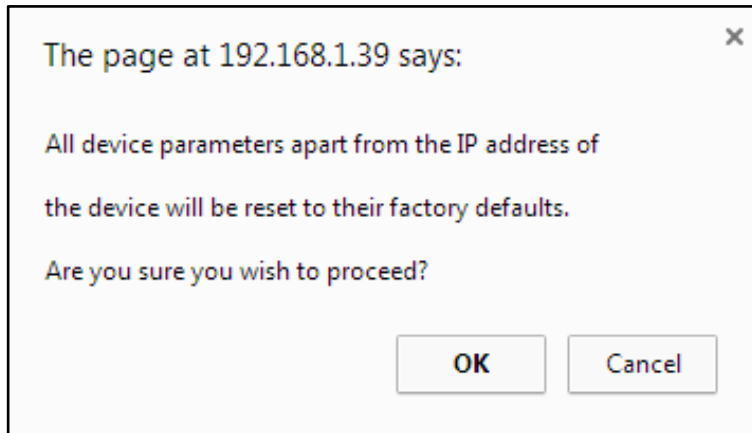

Figure 33: The Device Settings Page – Soft Factory Reset Message

Click OK to proceed.

7.5 The USB Routing Page

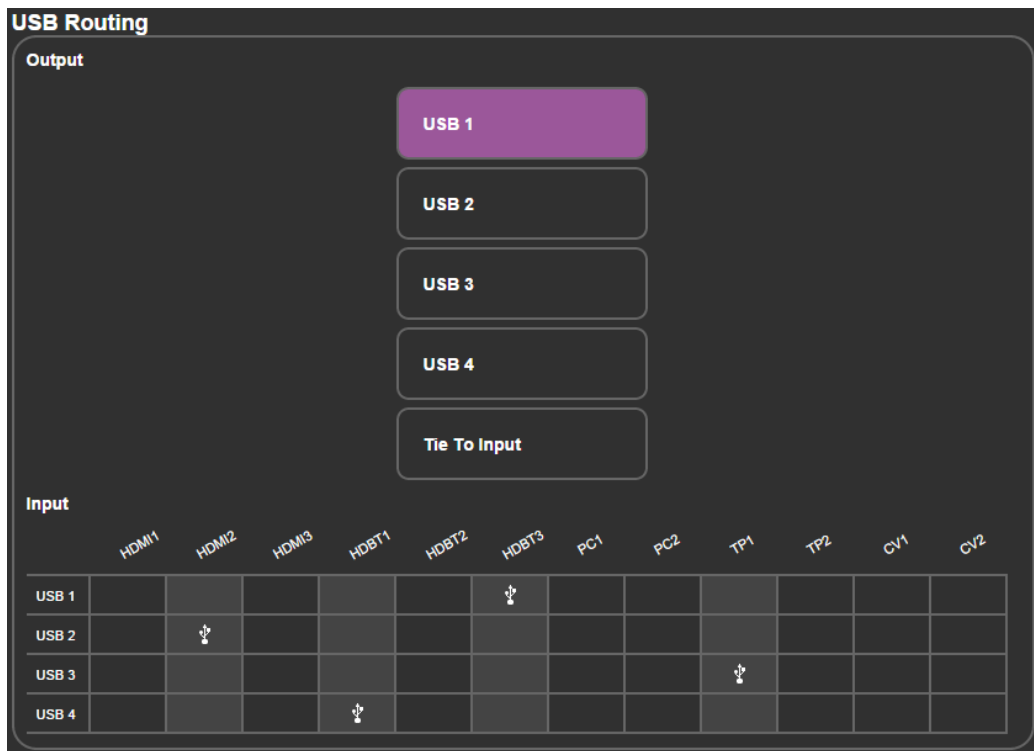

Figure 34: The USB Routing Page

The USB page lets you select one of the USB hosts (buttons USB 1, USB 2, USB 3 or USB 4 – in the example in [Figure 34](#), USB 1 is selected). The selected button is routed to the USB client.

The USB Routing page also lets you tie any of the USB ports to any of the switcher/scaler inputs that are routed to output 1. To do so click the **Tie To Input** button and then assign the USB 1 to 4 ports each to one of the inputs. In the example in [Figure 35](#) (if the Tie To INPUT button was selected) USB 1 is tied to HDMI 1, USB 2 is tied to HDMI 2 and so on.

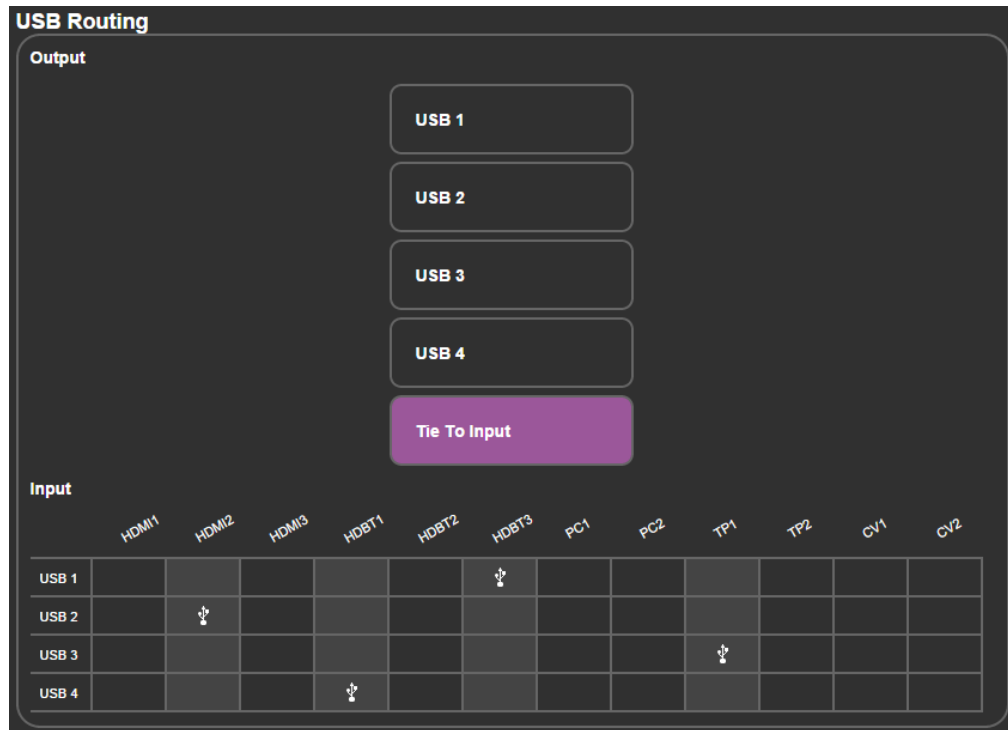

Figure 35: The USB Tied to a Selected Input

7.6 The Audio Settings Page

The audio settings page lets you define the audio parameters for the inputs, outputs (1 and 2), and the audio out (Monitor and Line out).

The main page lets you switch and set the selected audio signal to the two outputs and the independent audio output. The rear panel DIP-switch settings (see [Figure 2](#)): Auxiliary Settings, Stereo/Mono and Microphone, are displayed.

Note that the DIP-switch settings cannot be changed via the Web pages only physically on the rear panel.

The Input tab (see [Figure 36](#)) lets you set the volume individually for each input, including the analog and embedded audio HDMI signals.

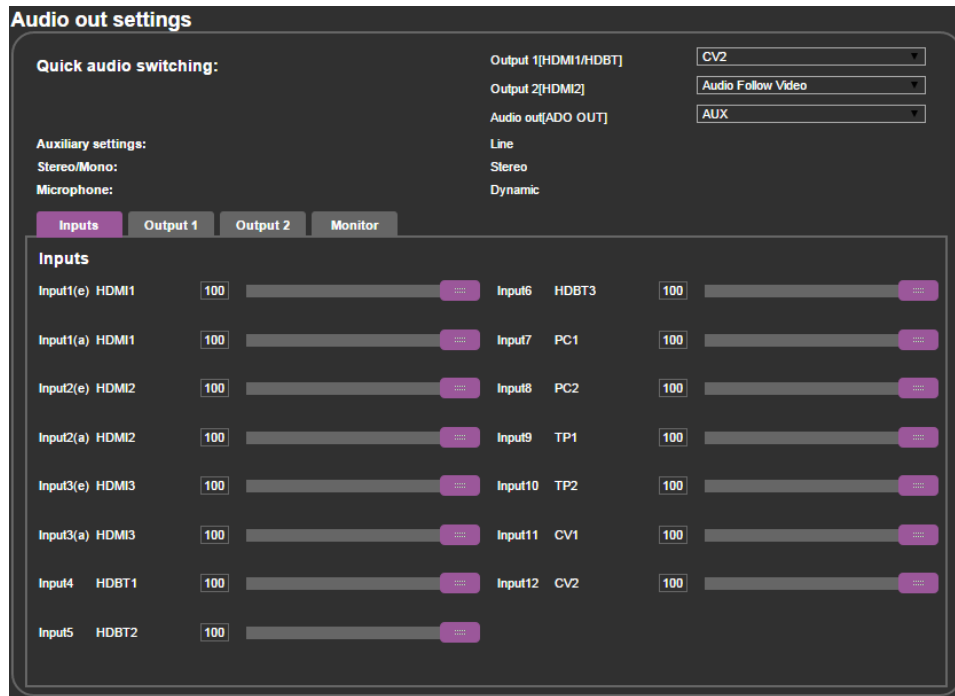

Figure 36: The Audio Settings Page – Inputs

[Figure 37](#) shows the output 1 equalizer settings:

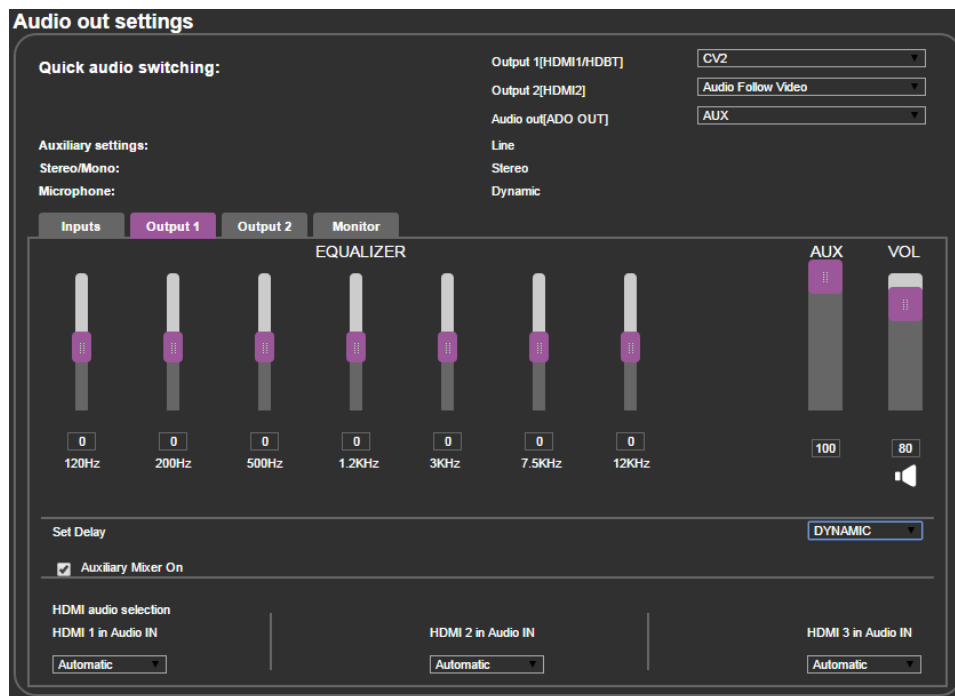

Figure 37: The Audio Settings Page – Output 1

[Figure 37](#) shows the output 2 equalizer settings:



Figure 38: The Audio Settings Page – Output 2

[Figure 37](#) shows the Monitor equalizer settings as well as the volume of the Aux, Line and Monitor volume levels:

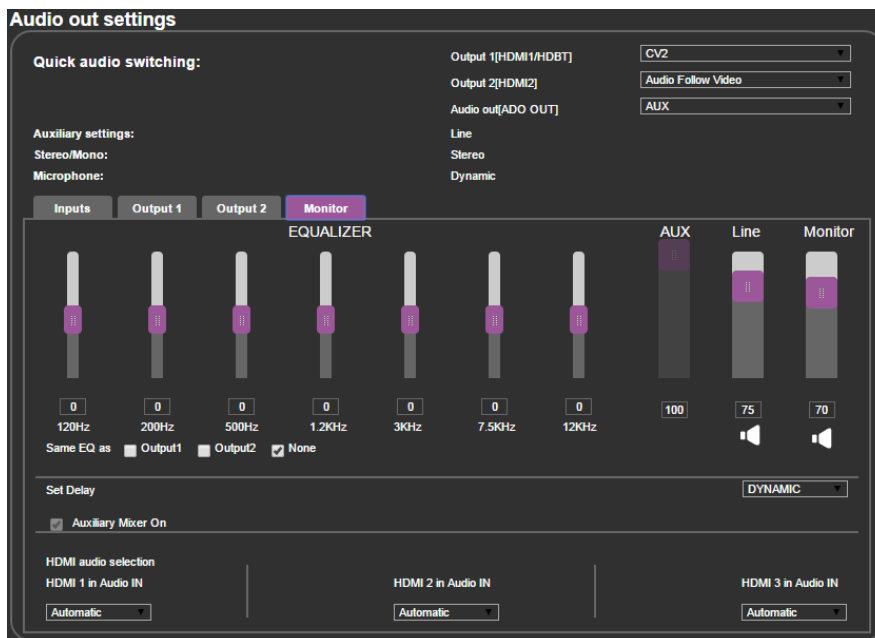

Figure 39: The Audio Settings Page – Monitor

7.7 The EDID Page

The EDID page lets you copy a selected resolution (Native Timing) or the default resolution (HDMI/HDBT or VGA) to one or more selected inputs.

EDID

Read from:

Default:

Default-HDMI/HDBT

Default-VGA

Native timing:

1024x768@60

1280x800@60

1280x1024@60

1366x768@60

1440x900@60

1400x1050@60

1600x900@60

1600x1200@60

1680x1050@60

1920x1200@60RB

Browser...

Copy to:

Inputs

HDMI 1

HDMI 2

HDMI 3

HDBT 1

HDBT 2

HDBT 3

PC 1

PC 2

Copy

NONE to NONE

Figure 40: The EDID Page

[Figure 41](#) shows how to select a resolution from the list and select one or more inputs. To copy, click the **Copy** button:

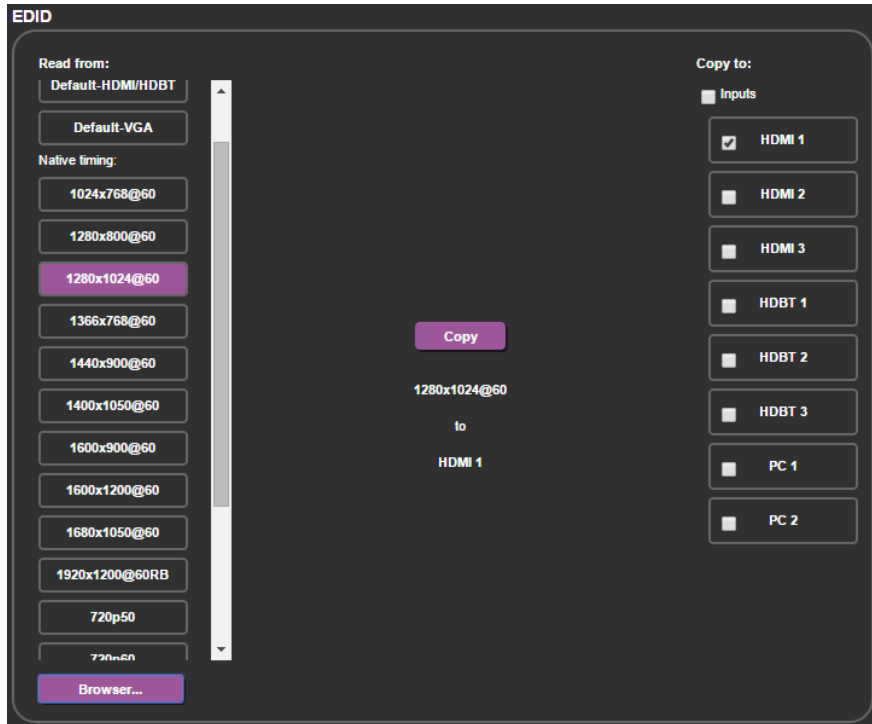

Figure 41: The EDID Page – Copying the Native Timing

[Figure 41](#) shows how to select one of the default resolutions from the list and select one or more inputs. To copy, click the **Copy** button:

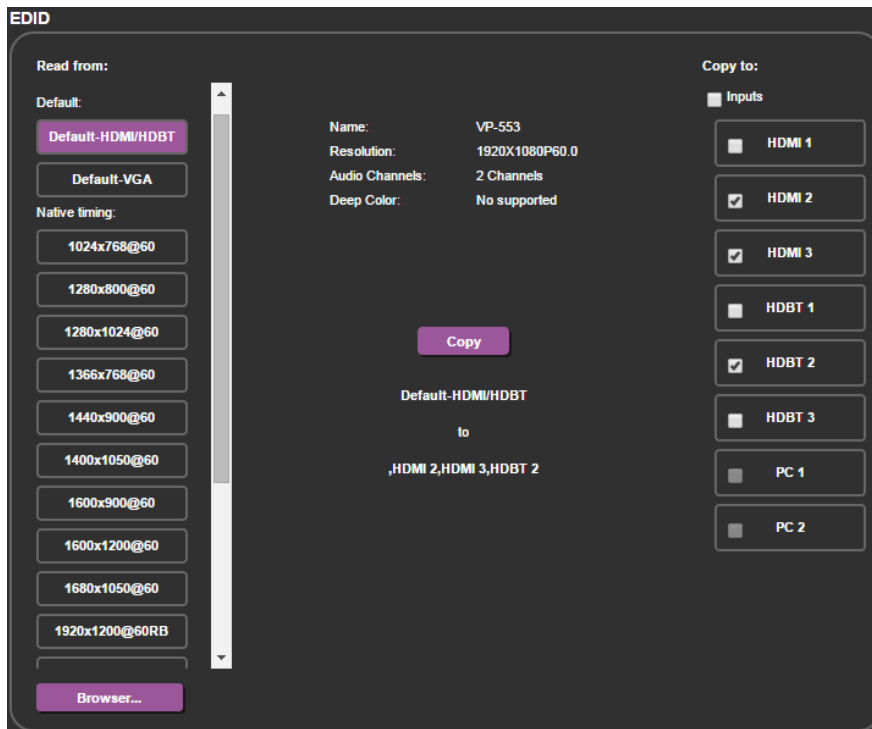

Figure 42: The EDID Page – Copying the Default

The EDID page displays the machine name, selected resolution, the audio channels and deep color support.

After clicking the **Copy** button, the EDID page shows the copy EDID results:

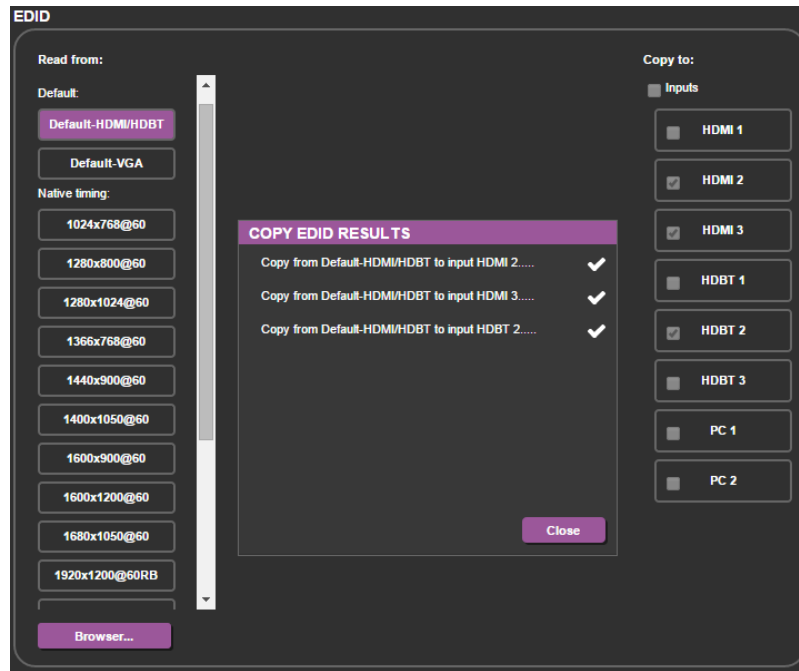

Figure 43: The EDID Page –The Copy EDID Results

7.8 The Data Routing Page

The data routing page lets you route the data over the HDBT ports (each port has a separate UDP IP port) via the RS-232 Data port, or the Ethernet (General or SID-X2N), see [Figure 44](#).

When selecting:

- RS-232 Data, you can transmit data from a controller connected to the RS-232 DATA port to one of the HDBaseT inputs or the HDBaseT output
- Ethernet-General, you can transmit data from a controller connected via the Ethernet port to one of the HDBaseT inputs or the HDBaseT output
- Ethernet-General, you can transmit data from a controller connected via the connected SID-X2 to the HDBaseT input to which it is connected

Figure 44: The Data Routing Page

Click the Set changes button to set the changes.

RS-232 Data Port: for each HDBaseT port you can set the following data settings:

- **Baud Rate:** 4800, 9600, 19200, 38400, 57600 or 115200
- **Data Bits:** 5, 6, 7 or 8
- **Parity:** NONE, EVEN, ODD, MARK or SPACE
- **Stop Bits:** 1 or 2
- **Flow Control:** OFF or ON

This way you can set the serial data in line with the serial data passed through.

SID-X2N Data transfer: if the Kramer SID-X2N is connected to an HDBT port

7.9 The Authentication Page

The Authentication page lets you set the user name and password as well as setting the inactivity logout. [Figure 45](#) shows the Authentication page:

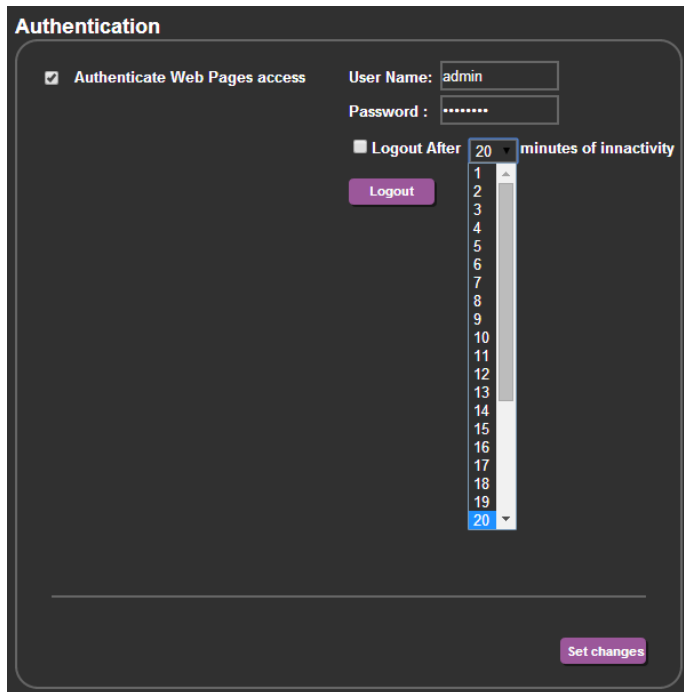

Figure 45: The Authentication Page

7.10 The About Page

The **VP-553** About page lets you view the Web page version and Kramer Electronics Ltd details.



Figure 46: The About Page

8 Technical Specifications

INPUTS:	<p>3 HDMI connectors (HDMI, HDCP) 2 VGA on 15-pin HD connectors 2 composite video on RCA connectors 2 analog TP on RJ-45 connectors 3 HDBT on RJ-45 connectors 4 USB ports 3 unbalanced analog audio on 3.5mm mini jacks for HDMI 2 unbalanced analog audio on 3.5mm mini jacks for PC 1 Aux in balanced stereo audio on 5-pin terminal block connectors 2 balanced audio (L and R) RCA connectors for CV</p>
OUTPUTS:	<p>1 HDBT on RJ-45 connector 2 HDMI connectors (HDMI, HDCP) 1 USB port Monitor out balanced stereo on a 5-pin terminal block connector Line out balanced stereo on a 5-pin terminal block connector</p>
OUTPUT RESOLUTIONS:	<p>NATIVE, 640x480@60, 800x600@60, 1024x768@60, 1280x768@60, 1360x768@60, 1280x720@60, 1280x800@60, 1280x1024@60, 1440x900@60, 1400x1050@60, 1680x1050@60, 1600x1200@60, 1920x1080@60, 1920x1200@60, 720x480p@60, 1280x720p@60, 1920x1080i@60, 1920x1080p@60, 720x576p@60, 1280x720p@50, 1920x1080i@50, 1920x1080p@50</p>
CONTROLS:	<p>TP 1, TP 2, CV 1, CV 2, HDBT 1, HDBT 2, HDBT 3, PC 1, PC 2, HDMI 1, HDMI 2, HDMI 3, USB 1, USB 2, USB 3, USB 4 input selector buttons; 2 blank, 2 mute, 2 freeze buttons; menu, enter, menu arrows, reset to XGA/720p, OSD SELECT, 2 RS-232, IR, Ethernet, 2 level and EQ trimmers, line/mic selector switch, cond/dyn selector switch, mono/stereo selector switch, REM for muting audio</p>
POWER CONSUMPTION:	100-240V AC, 43VA max.
OPERATING TEMPERATURE:	0° to +40°C (32° to 104°F)
STORAGE TEMPERATURE:	-40° to +70°C (-40° to 158°F)
HUMIDITY:	10% to 90%, RHL non-condensing
DIMENSIONS:	19" x 7" x 2U (W, D, H) rack mountable
WEIGHT:	2.7kg (6lbs) approx.
INCLUDED ACCESSORIES:	Power cord, rack ears, IR remote control
OPTIONS:	Kramer BC-HDKat6a cable
Specifications are subject to change without notice at http://www.kramerelectronics.com	

8.1 Default Communication Parameters

RS-232	
Baud Rate:	Any baud rate up to 115,200
Data Bits:	8
Stop Bits:	1
Parity:	None
Command Format:	ASCII
Example (Route the video from the HDMI3 input to the HDMI1 output port):	#ROUTE 1,1,2<cr>
Ethernet	
To reset the IP settings to the factory reset values go to : Menu-> Factory-> RESET->Change the option to YES and press Enter	
IP Address:	192.168.1.39
Subnet mask:	255.255.255.0
Default gateway:	192.168.1.254
TCP Port #:	Not supported
Default UDP Port #:	50000
Maximum UDP Ports:	4
Full Factory Reset	
OSD	Go to : Menu-> Factory-> RESET->Change the option to YES and press Enter

8.2 Input Resolutions

Resolution/Refresh Rate	CV	PC	HDMI
NTSC	Yes	No	No
PAL	Yes	No	No
640x480 (@60/72/75Hz)	No	Yes	Yes
800x600 (@56/60/72/75Hz)	No	Yes	Yes
1024x768 (@60/70/75Hz)	No	Yes	Yes
1152x864 @75Hz	No	Yes	Yes
1280x720 @60Hz	No	Yes	Yes
1280x768 @60Hz	No	Yes	No
1280x800 @60Hz	No	Yes	Yes
1280x960 @60Hz	No	Yes	Yes
1280x1024 (@60/75Hz)	No	Yes	Yes
1360x768 @60Hz	No	Yes	Yes
1400x1050 @60Hz	No	Yes	Yes
1440x900 @60Hz	No	Yes	Yes
1600x900 RB @60Hz	No	Yes	Yes
1600x1200 @60Hz	No	Yes	Yes
1680x1050 RB @60Hz	No	Yes	Yes
1920x1080 @60Hz	No	Yes	Yes
1920x1200 RB @60Hz	No	Yes	Yes
480I/576I	No	No	Yes
480P/576P	No	No	Yes
720P(@50/60Hz)	No	No	Yes
1080I(@50/60Hz)	No	No	Yes
1080P(@24/30Hz)	No	No	Yes
1080P(@50/60Hz)	No	No	Yes

9 The VP-553 RS-232 Communication Protocol

The **VP-553** can be operated using serial commands from a PC, remote controller, or touch screen. The unit communicates using the default Kramer Protocol 3000.

- Kramer Protocol 3000 syntax (see [Section 9.1](#))
- Kramer Protocol 3000 command list (see [Section 9.2](#))
- Kramer Protocol 3000 detailed commands (See [Section 9.3](#))

9.1 Kramer Protocol 3000 Syntax

Protocol 3000 communicates at a data rate of 115200 baud, no parity, 8 data bits and 1 stop bit.

9.1.1 Host Message Format

Start	Address (optional)	Body	Delimiter
#	<i>Destination_id@</i>	Message	CR

Simple Command

Command string with only one command without addressing:

Start	Body	Delimiter
#	Command SP <i>Parameter_1,Parameter_2,...</i>	CR

Command String

Formal syntax with commands concatenation and addressing:

Start	Address	Body	Delimiter
#	<i>Destination_id@</i>	Command_1 <i>Parameter1_1,Parameter1_2,...</i> Command_2 <i>Parameter2_1,Parameter2_2,...</i> Command_3 <i>Parameter3_1,Parameter3_2,...</i> ...	CR

9.1.2 Device Message Format

Start	Address (optional)	Body	delimiter
~	<i>Sender_id@</i>	Message	CR LF

Device Long Response

Echoing command:

Start	Address (optional)	Body	Delimiter
~	<i>Sender_id@</i>	Command SP [<i>Param1 ,Param2 ...</i>] result	CR LF

CR = Carriage return (ASCII 13 = 0x0D)

LF = Line feed (ASCII 10 = 0x0A)

SP = Space (ASCII 32 = 0x20)

9.1.3 Command Terms

Command

A sequence of ASCII letters ('A'-'Z', 'a'-'z' and '-').

Command and parameters must be separated by at least one space.

Parameters

A sequence of alphanumeric ASCII characters ('0'-'9', 'A'-'Z', 'a'-'z' and some special characters for specific commands). Parameters are separated by commas.

Message string

Every command entered as part of a message string begins with a **message starting character** and ends with a **message closing character**.

Note: A string can contain more than one command. Commands are separated by a pipe ('|') character.

Message starting character

'#' – For host command/query

'~' – For machine response

Device address (Optional, for K-NET)

K-NET Device ID followed by '@'

Query sign

'?' follows some commands to define a query request.

Message closing character

CR – For host messages; carriage return (ASCII 13)

CRLF – For machine messages; carriage return (ASCII 13) + line-feed (ASCII 10)

Command chain separator character

When a message string contains more than one command, a pipe ('|') character separates each command.

Spaces between parameters or command terms are ignored.

9.1.4 Entering Commands

You can directly enter all commands using a terminal with ASCII communications software, such as HyperTerminal, Hercules, etc. Connect the terminal to the serial or Ethernet port on the Kramer device. To enter **CR** press the Enter key. (**LF** is also sent but is ignored by command parser).

For commands sent from some non-Kramer controllers like Crestron, some characters require special coding (such as, /X##). Refer to the controller manual.

9.1.5 Command Forms

Some commands have short name syntax in addition to long name syntax to allow faster typing. The response is always in long syntax.

9.1.6 Command Chaining

Multiple commands can be chained in the same string. Each command is delimited by a pipe character ('|'). When chaining commands, enter the **message starting character** and the **message closing character** only once, at the beginning of the string and at the end.

Commands in the string do not execute until the closing character is entered.

A separate response is sent for every command in the chain.

9.1.7 Maximum String Length

64 characters

9.2 Kramer Protocol 3000 – Command List

Command	Short Form	Description
#		Protocol handshaking
#HELP		List of commands
#BUILD-DATE?		Read device build date
#FACTORY		Reset to factory default configuration
#MODEL?		Read device model
#PROT-VER?		Read device protocol version
#RESET		Reset device
#VERSION?		Read device firmware version
#NET-MAC?	NTMC?	Get MAC address
#NET-IP	NTIP	Set device IP address
#NET-IP?	NTIP?	Get device IP address
#NET-GATE	NTGT	Set Gateway IP
#NET-GATE?	NTGT?	Get Gateway IP
#NET-MASK	NTMSK	Set device subnet mask
#NET-MASK?	NTMSK?	Get device subnet mask
#NET-DHCP	NTDH	Set DHCP mode
#NET-DHCP?	NTDH?	Get DHCP mode
#LOAD		For K-upload tool
#CPEDID		
#GEDID		
#GEDID?		
#ROUTE		
#ROUTE?		
#SIGNAL?		Get input signal lock status
#DISPLAY?		Get output HPD status
#LOCK-FP	LCK	Lock front panel
#LOCK-FP?	LCK?	GET Lock front panel
#HDCP-MOD		
#HDCP-MOD?		
#VID-RES		Set input/output resolution
#VID-RES?		Get input/output resolution
#VMUTE		
#VMUTE?		
#VFRZ		
#VFRZ?		
#AUD-LVL		Set audio level
#AUD-LVL?		Get audio level
#MIX		
#MIX?		
#MIX-LVL		
#MIX-LVL?		

Command	Short Form	Description
#MUTE		
#MUTE?		
#SCLR-AS		
#SCLR-AS?		
#IMAGE-PROP		
#IMAGE-PROP?		
#SCLR-PCAUTO		
#SCLR-AUDIO-DELAY		
#SCLR-AUDIO-DELAY?		
#EQ-LVL		
#EQ-LVL?		
#SHOW-OSD		
#SHOW-OSD?		
#MIC-GAIN		
#MIC-GAIN?		
#DPSW-STATUS?		

9.3 Kramer Protocol 3000 – Detailed Commands

This section describes the detailed commands list (see [Section 9.3.3](#)) as well as the Port number key (see [Section 9.3.1](#)) and the video resolutions key (see [Section 9.3.2](#)).

9.3.1 Port Number Key

Video	#
HDMI 1	0
HDMI 2	1
HDMI 3	2
HDBT 1	3
HDBT 2	4
HDBT 3	5
PC 1	6
PC 2	7
TP 1	8
TP 2	9
CV 1	10
CV 2	11

Audio input	#
HDMI 1 (EMB)	0:1
HDMI 1 (A)	0:2
HDMI 2 (EMB)	1:1
HDMI 2 (A)	1:2
HDMI 3 (EMB)	2:1
HDMI 3 (A)	2:2
HDBT 1	3
HDBT 2	4
HDBT 3	5
PC 1	6
PC 2	7
TP 1	8
TP 2	9
CV 1	10
CV 2	11
Aux IN	12

Video Output	#
HDMI 1	0
HDBT 1	1
HDMI 2	2

USB Host	#
USB 1	0
USB 2	1
USB 3	2
USB 4	3

Audio Output	#
Line OUT	0:0
Monitor OUT	0:1

9.3.2 The Resolutions key

#	Resolution	#	Resolution
0	Native	14	N/A
1	640x480	15	N/A
2	800x600	16	1920x1200
3	1024x768	17	480P60
4	1280x768	18	720P60
5	1360x768	19	1080P60
6	1280x720	20	1080I60
7	1280x800	21	N/A
8	1280x1024	22	576P50
9	1440x900	23	720P50
10	1400x1050	24	1080P50
11	1680x1050	25	1080I50
12	1600x1200	26	N/A
13	1920x1080		

9.3.3 The Commands

Command – HELP		Command Type – System-mandatory	
Command Name		Permission	Transparency
Set:	-	-	-
Get:	HELP	End User	-
Description		Syntax	
Set:	-	-	
Get :	Get command list or help for specific command	2 options: 1. # HELP _{CR} 2. # HELP _{SP} command_name _{CR}	
Response			
1. Multi-line: ~ _{nn} @ Device available protocol 3000 commands : _{CR LF} command _{SP} command... _{CR LF} To get help for command use : HELP (COMMAND_NAME) _{CR LF}			
2. Multi-line: ~ _{nn} @ HELP _{SP} command: _{CR LF} description _{CR LF} USAGE : usage _{CR LF}			

Command – BUILD-DATE		Command Type – System-mandatory	
Command Name		Permission	Transparency
Set:	BUILD-DATE	End User	-
Get:	-	-	-
Description		Syntax	
Set:	Read device build date	# BUILD-DATE? _{CR}	
Get :	-	-	
Response			
~ _{nn} @ BUILD-DATE _{SP} date _{SP} time _{CR LF}			
Parameters			
<i>date</i> – Format: YYYY/MM/DD where YYYY = Year, MM = Month, DD = Day <i>time</i> – Format: hh:mm:ss where hh = hours, mm = minutes, ss = seconds			

Command – FACTORY		Command Type – System-mandatory	
Command Name		Permission	Transparency
Set:	FACTORY	End User	-
Get:	-	-	-
Description		Syntax	
Set:	Reset device to factory defaults configuration	#FACTORY _{CR}	
Get :	-	-	
Response			
~nn@BUILD-DATE _{SP} date _{SP} time _{CR LF}			
Notes			
This command deletes all user data from the device. The deletion can take some time.			
Command – MODEL?		Command Type – System-mandatory	
Command Name		Permission	Transparency
Set:	-	-	-
Get:	MODEL?	End User	-
Description		Syntax	
Set:	-	-	
Get :	Get device model	#MODEL? _{CR}	
Response			
~nn@MODEL _{SP} model_name _{CR LF}			
Parameters			
model_name – String of up to 19 printable ASCII chars			

Command – PROT-VER?		Command Type – System-mandatory	
Command Name		Permission	Transparency
Set:	-	-	-
Get:	PROT-VER?	End User	-
Description		Syntax	
Set:	-	-	
Get :	Get protocol version	#PROT-VER? _{CR}	
Response			
~nn@PROT-VER _{SP} 3000:version _{CR LF}			
Parameters			
Version – Format: XX.XX where X is a decimal digit			

Command – RESET		Command Type – System-mandatory	
Command Name		Permission	Transparency
Set:	RESET	Administrator	-
Get:	-	-	-
Description		Syntax	
Set:	Reset device	#RESET <input type="checkbox"/> <input type="checkbox"/>	
Get :	-	-	
Response			
~ <input type="checkbox"/> <input type="checkbox"/> @RESET <input type="checkbox"/> OK <input type="checkbox"/> <input type="checkbox"/>			
Notes			
To avoid locking the port due to a USB bug in Windows, disconnect USB connections immediately after running this command. If the port was locked, disconnect and reconnect the cable to reopen the port.			

Command – VERSION?		Command Type – System-mandatory	
Command Name		Permission	Transparency
Set:	-	-	-
Get:	VERSION?	End User	-
Description		Syntax	
Set:	-	-	
Get :	Get version number	#VERSION? <input type="checkbox"/> <input type="checkbox"/>	
Response			
~ <input type="checkbox"/> <input type="checkbox"/> @VERSION <input type="checkbox"/> firmware_version <input type="checkbox"/> <input type="checkbox"/>			
Parameters			
<i>firmware_version</i> – Format: XX.XX.XXXX where the digits group are: major.minor.build version			

Command – NET-MAC?		Command Type – Communication	
Command Name		Permission	Transparency
Set:	-	-	-
Get:	NET-MAC?	End User	-
Description		Syntax	
Set:			
Get :	Get MAC address	#NET-MAC? <input type="checkbox"/> <input type="checkbox"/>	
Response			
~ <input type="checkbox"/> <input type="checkbox"/> @NET-MAC <input type="checkbox"/> mac_address <input type="checkbox"/> <input type="checkbox"/>			
Parameters			
<i>mac_address</i> – Unique MAC address. Format: XX-XX-XX-XX-XX-XX where X is hex digit.			

Command – NET-IP		Command Type – Communication	
Command Name		Permission	Transparency
Set:	NET-IP	Administrator	-
Get:	NET-IP?	End User	-
Description		Syntax	
Set:	Set device IP address	#NET-IP _{SP} P1 _{CR}	
Get :	Get device IP address	#NET-IP? _{CR}	
Response			
Set: ~nn@ NET-IP _{SP} ip_address _{SP} OK _{CR LF}			
Get: ~nn@ NET-IP _{SP} ip_address _{CR LF}			
Parameters			
P1 (valid IP address)= xxx.xxx.xxx.xxx			
Notes			
For proper settings consult your network administrator.			

Command – NET-GATE		Command Type – Communication	
Command Name		Permission	Transparency
Set:	NET-GATE	Administrator	-
Get:	NET-GATE?	End User	-
Description		Syntax	
Set:	Set Gateway IP	#NET-GATE _{SP} P1 _{CR}	
Get :	Get Gateway IP	#NET-GATE? _{CR}	
Response			
Set: ~nn@ NET-GATE _{SP} P1 _{SP} OK _{CR LF}			
Get: ~nn@ NET-GATE _{SP} ip_address _{CR LF}			
Parameters			
P1 (valid IP address)=xxx.xxx.xxx.xxx			
Notes			
A network gateway connects the device via another network and maybe over the Internet. Be careful of security problems. For proper settings consult your network administrator			

Command – NET-MASK		Command Type – Communication	
Command Name		Permission	Transparency
Set:	NET-MASK	Administrator	-
Get:	NET-MASK?	End User	-
Description		Syntax	
Set:	Set device subnet mask	#NET-MASK _{SP} net_mask _{CR}	
Get :	Get device subnet mask	#NET-MASK? _{CR}	
Response			
Set: ~nn@NET-MASK _{SP} P1 _{SP} OK _{CR LF}			
Get: ~nn@NET-MASK _{SP} net_mask _{CR LF}			
Parameters			
P1 (valid IP address)=xxx.xxx.xxx.xxx			
Response triggers			
The subnet mask limits the Ethernet connection within the local network. For proper settings consult your network administrator.			

Command – NET-DHCP		Command Type – Communication	
Command Name		Permission	Transparency
Set:	NET-DHCP	Administrator	-
Get:	NET-DHCP?	End User	-
Description		Syntax	
Set:	Set DHCP mode	#NET-DHCP _{SP} P1 _{CR}	
Get :	Get DHCP mode	#NET-DHCP? _{CR}	
Response			
Set: ~nn@ NET-DHCP _{SP} P1 _{SP} OK _{CR LF}			
Get: ~nn@ NET-DHCP _{SP} mode _{CR LF}			
Parameters			
P1 (Off/On)– 0=off; 1=on			
0 – Do not use DHCP. Use the IP set by the factory or using the IP set command. 1 – Try to use DHCP. If unavailable, use IP as above.			
Notes			
Connecting Ethernet to devices with DHCP may take more time in some networks. To connect with a randomly assigned IP by DHCP, specify the device DNS name (if available) using the command “NAME”. You can also get an assigned IP by direct connection to USB or RS-232 protocol port if available. For proper settings consult your network administrator.			

Command - LOAD		Command Type - System - Packets	
Command Name		Permission	Transparency
Set:	LOAD	Administrator	Public
Get:	-	-	-
Description		Syntax	
Set:	Load file to device	#LOAD _{SP} file_name,size _{CR}	
Get:	-	-	
Response			
Data sending negotiation:			
* Device -			
~01@LOAD _{SP} file_name,size _{SP} READY _{CR LF}			
* End User (+Device)-			
Send file in Protocol Packets			
* Device -			
~01@LOAD _{SP} file_name, size _{SP} OK _{CR LF}			
Parameters			
file_name - name of file to save on device			
size - size of file data that is sent.			

Command - CPEDID		Command Type - System	
Command Name		Permission	Transparency
Set:	CPEDID	End User	Public
Get:	-	-	-
Description		Syntax	
Set:	Copy EDID data from the output to the input EEPROM	#CPEDID _{SP} P1, P2, P3, P4 _{CR}	
Get:	-	-	
Response			
~nn@CPEDID _{SP} P1, P2, P3, P4 _{CR LF}			
Parameters			
P1 (source type) – 1=output			
P2 (source ID) – 0=HDMI1; 1=HDBT1; 2=HDMI2			
P3 (destination type) – 0=input			
P4 (bitmap representing destination IDs) – 0=HDMI1; 1=HDMI2; 2=HDMI3; 3=HDBT1; 4=HDBT2; 5=HDBT3			
Format: XXXX...X, where X is hex digit. The binary form of every hex digit represents corresponding destinations. Setting '1' says that EDID data has to be copied to this destination			
Response Triggers			
Response is sent to the com port from which the Set was received (before execution)			
Notes			
Destination bitmap size depends on device properties (for 64 inputs it is a 64-bit word)			
Example: bitmap 0x0013 means inputs 1,2 and 5 are loaded with the new EDID			

Command - GEDID		Command Type - System	
Command Name		Permission	Transparency
Set:	GEDID	Administrator	Public
Get:	GEDID?	End User	Public
Description		Syntax	
Set:	Set EDID data from device	# GEDID <input type="checkbox"/> _{SP} P1, P2 <input type="checkbox"/> _{CR}	
Get:	Get EDID support on certain input/output	# GEDID? <input type="checkbox"/> _{SP} P1, P2 <input type="checkbox"/> _{CR}	
Response			
Set: Multi-line response: ~ <input type="checkbox"/> nn@ GEDID <input type="checkbox"/> _{SP} P1,P2,size <input type="checkbox"/> _{CR} <input type="checkbox"/> _{LF} EDID_data <input type="checkbox"/> _{CR} <input type="checkbox"/> _{LF} ~ <input type="checkbox"/> nn@ GEDID <input type="checkbox"/> _{SP} P1,P2 <input type="checkbox"/> _{SP} OK <input type="checkbox"/> _{CR} <input type="checkbox"/> _{LF}			
Get: ~ <input type="checkbox"/> nn@ GEDID <input type="checkbox"/> _{SP} P1, P2,size <input type="checkbox"/> _{CR} <input type="checkbox"/> _{LF}			
Parameters			
P1 (stage) – 0=input; 1=output P2 (stage_id) - (Input/Output number valid according to the selected Input/Output according to P1) – video inputs=(0~7); Video outputs =(0,1,2) (see Section 9.3.1) Size - EDID data size. For Set, size of data to be sent from device, for Get, 0 means no EDID support			
Response Triggers			
Response is sent to the com port from which the Set (before execution) / Get command was received			
Notes			
For Get, size=0 means EDID is not supported For old devices that do not support this command, ~ <input type="checkbox"/> nn@ ERR 002 <input type="checkbox"/> _{CR} <input type="checkbox"/> _{LF} is received			

Command – ROUTE		Command Type –	
Command Name		Permission	Transparency
Set:	ROUTE	End User	-
Get:	ROUTE?	End User	-
Description		Syntax	
Set:	Set layer routing	# ROUTE <input type="checkbox"/> _{SP} P1,P2,P3 <input type="checkbox"/> _{CR}	
Get :	Get layer routing	# ROUTE? <input type="checkbox"/> _{SP} P1,P2 <input type="checkbox"/> _{CR}	
Response			
~ <input type="checkbox"/> nn@ ROUTE <input type="checkbox"/> _{SP} P1,P2,P3 <input type="checkbox"/> _{CR} <input type="checkbox"/> _{LF}			
Parameters			
P1 (Layer number) – 1=Video; 2=Audio; 3=USB; 12=Video+Audio; 13=Video+USB; 123=Video+Audio+USB P2 (Route to, 0-1-2 are valid according to the selected layer according to P1) – 0=Audio Out; 1=Scaler1; 2=Scaler2 P3 (Route from, valid values are in accordance to the selected layer and Route to selected according to P1 and P2) – video inputs=(0~11); Audio inputs=(0~12); USB hosts=(0~3) – see Section 9.3.1			
Notes			
This command replaces all other routing commands.			

Command – SIGNAL		Command Type - System	
Command Name		Permission	Transparency
Set :	-	-	-
Get	SIGNAL?	End User	Public
Description		Syntax	
Set:	-	-	
Get:	Get input signal lock status	# SIGNAL? <input type="checkbox"/> _{SP} P1 <input type="checkbox"/> _{CR}	
Response			
~ <input type="checkbox"/> _{nn} @ SIGNAL <input type="checkbox"/> _{SP} P1,P2 <input type="checkbox"/> _{CR} <input type="checkbox"/> _{LF}			
Parameters			
P1 (Input number)– 0: HDMI1; 1: HDMI2; 2: HDMI3; 3: HDBT1; 4: HDBT2; 5: HDBT3 P2 – 0=Off; 1=On			
Response triggers			
<ul style="list-style-type: none"> • After execution, response is sent to the com port from which the Get was received • Response is sent after every change in input signal status ON to OFF, or OFF to ON 			

Command – DISPLAY?		Command Type - System	
Command Name		Permission	Transparency
Set :	-	-	-
Get	DISPLAY?	End User	Public
Description		Syntax	
Set:	-	-	
Get:	Get output HPD status	# DISPLAY? <input type="checkbox"/> _{SP} P1 <input type="checkbox"/> _{CR}	
Response			
~ <input type="checkbox"/> _{nn} @ DISPLAY <input type="checkbox"/> _{SP} P1,P2 <input type="checkbox"/> _{CR} <input type="checkbox"/> _{LF}			
Parameters			
P1 (Output number) – 0=HDMI1; 1=HDBT1; 2=HDMI2 P2 – 0=Off; 1=On			
Response triggers			
<ul style="list-style-type: none"> • After execution, response is sent to the com port from which the Get was received • Response is sent after every change in output HPD status ON to OFF • Response is sent after every change in output HPD status OFF to ON and ALL parameters (new EDID, etc.) are stable and valid 			

Command – LOCK-FP		Command Type – System	
Command Name		Permission	Transparency
Set:	LOCK-FP	End User	-
Get:	LOCK-FP?	End User	-
Description		Syntax	
Set:	Lock front panel	# LOCK-FP <input type="checkbox"/> _{SP} P1 <input type="checkbox"/> _{CR}	
Get :	Get front panel lock state	# LOCK-FP? <input type="checkbox"/> _{CR}	
Response			
<input type="checkbox"/> @ LOCK-FP <input type="checkbox"/> _{SP} P1 <input type="checkbox"/> _{SP} OK <input type="checkbox"/> _{CR} <input type="checkbox"/> _{LF}			
Parameters			
P1 (Off/On)– 0=Off; 1=On			

Command – HDCP-MOD		Command Type – System	
Command Name		Permission	Transparency
Set:	HDCP-MOD	Administrator	Public
Get:	HDCP-MOD?	End User	Public
Description		Syntax	
Set:	Set HDCP mode	# HDCP-MOD <input type="checkbox"/> _{SP} P1,P2,P3 <input type="checkbox"/> _{CR}	
Get :	Get HDCP mode	# HDCP-MOD? <input type="checkbox"/> _{SP} P1,P2 <input type="checkbox"/> _{CR}	
Response			
Set / Get : ~ <input type="checkbox"/> @ HDCP-MOD <input type="checkbox"/> _{SP} P1,P2,P3 <input type="checkbox"/> _{CR} <input type="checkbox"/> _{LF}			
Parameters			
P1 (Input/Output) – 0=Input; 1=Output P2 (Scaler number) – 1=Scaler1; 2=Scaler2 P3 (Status) – 0=Off; 1=On; 2=Follow In, 3=Follow Out			
Response triggers			
<ul style="list-style-type: none"> Response is sent to the com port from which the Set (before execution) / Get command was received Response is sent to all com ports after execution if HDCP-MOD was set any other external control device (button press, device menu and similar) or genlock status changed 			
Notes			
Set HDCP working mode on device input : HDCP supported – HDCP_ON [default] HDCP not supported – HDCP OFF HDCP support changes following detected sink – MIRROR OUTPUT			

Command – VID-RES		Command Type - Video	
Command Name		Permission	Transparency
Set :	VID-RES	End User	Public
Get	VID-RES?	End User	Public
Description		Syntax	
Set:	Set video resolution	#VID-RES <input type="checkbox"/> _{SP} P1,P2,P3,P4 <input type="checkbox"/> _{CR}	
Get:	Get video resolution	#VID-RES? <input type="checkbox"/> _{SP} P1,P2,P3 <input type="checkbox"/> _{CR}	
Response			
~ <input type="checkbox"/> _{nn} @VID-RES <input type="checkbox"/> _{SP} P1,P2,P3,P4 <input type="checkbox"/> _{CR LF}			
Parameters			
P1 – 0=Input; 1=Output P2 – 1=Scaler1; 2=Scaler2 P3 – 0=Off; 1=On P4 - video resolutions see Section 9.3.2			
Response triggers			
<ul style="list-style-type: none"> • After execution, response is sent to the com port from which the Set /Get was received • After execution, response is sent to all com ports if VID-RES was set by any other external control device (button press, device menu and similar) 			
Notes			
<ol style="list-style-type: none"> 1. "Set" command is only applicable for stage=Output 2. "Set" command with <i>is_native=ON</i> sets native resolution on selected output (resolution index sent = 0). Device sends as answer actual VIC ID of native resolution 3. "Get" command with <i>is_native=ON</i> returns native resolution VIC, with <i>is_native=OFF</i> returns current resolution 			

Command – VMUTE		Command Type – Video	
Command Name		Permission	Transparency
Set:	VMUTE	End User	-
Get:	VMUTE?	End User	-
Description		Syntax	
Set:	Set enable/ disable video on output	# VMUTE <input type="checkbox"/> _{SP} P1,P2 <input type="checkbox"/> _{CR}	
Get :	Get video on output status	# VMUTE? <input type="checkbox"/> _{SP} P1 <input type="checkbox"/> _{CR}	
Response			
Set / Get : ~ <input type="checkbox"/> _{nn} @ VMUTE <input type="checkbox"/> _{SP} P1,P2 <input type="checkbox"/> _{CR LF}			
Parameters			
P1 (Scaler number) – 1=Scaler1; 2=Scaler2 P2 (Off/On) – 0=Off; 1=On			

Command – W-FRZ		Command Type – Video	
Command Name		Permission	Transparency
Set:	W-FRZ	End User	-
Get:	W-FRZ?	End User	-
Description		Syntax	
Set:	Set freeze video on output	# W-FRZ <input type="checkbox"/> _{SP} P1,P2 <input type="checkbox"/> _{CR}	
Get :	Get freeze on output status	# W-FRZ? <input type="checkbox"/> _{SP} P1 <input type="checkbox"/> _{CR}	
Response			
Set / Get : ~ <input type="checkbox"/> _{NN} @ W-FRZ <input type="checkbox"/> _{SP} P1,P2 <input type="checkbox"/> _{CR} <input type="checkbox"/> _{LF}			
Parameters			
P1 (Scaler number) – 1=Scaler1; 2=Scaler2 P2 (Off/On) – 0=Off; 1=On			

Command – AUD-LVL		Command Type – Audio	
Command Name		Permission	Transparency
Set:	AUD-LVL	End User	-
Get:	AUD-LVL?	End User	-
Description		Syntax	
Set:	Set audio level in specific amplifier stage	# AUD-LVL <input type="checkbox"/> _{SP} P1,P2,P3 <input type="checkbox"/> _{CR}	
Get :	Get audio level in specific amplifier stage	# AUD-LVL? <input type="checkbox"/> _{SP} P1,P2 <input type="checkbox"/> _{CR}	
Response			
~ <input type="checkbox"/> _{NN} @ AUD-LVL <input type="checkbox"/> _{SP} P1,P2 <input type="checkbox"/> _{CR} <input type="checkbox"/> _{LF}			
Parameters			
P1 (Input/Output)– 0=Input; 1=Output P2 (Input/Output number valid according to the selected Input/Output according to P1) – video inputs=(0~11); audio inputs=(0~12);audio outputs (– see Section 9.3.1) P3 – 0~100			

Command – MIX		Command Type – Audio	
Command Name		Permission	Transparency
Set:	MIX	End User	-
Get:	MIX?	End User	-
Description		Syntax	
Set:	Set audio MIX	# MIX <input type="checkbox"/> _{SP} P1,P2 <input type="checkbox"/> _{CR}	
Get :	Get audio MIX	# MIX? <input type="checkbox"/> _{SP} P1 <input type="checkbox"/> _{CR}	
Response			
~ <input type="checkbox"/> _{NN} @ MIX <input type="checkbox"/> _{SP} channel, mix_mode <input type="checkbox"/> _{CR} <input type="checkbox"/> _{LF}			
Parameters			
P1 (Output number) – 0=Audio out; 1=Scaler 1; 2=Scaler2 P2 (Off/On)– 0=Off; 1=On			

Command – Mixing Level		Command Type – [Audio]	
Command Name		Permission	Transparency
Set:	MIX-LVL	End User	Public
Get:	MIX-LVL?	End User	Public
Description		Syntax	
Set:	Set the mixing level of the selected output	# MIX-LVL <input type="checkbox"/> _{SP} P1,P2 <input type="checkbox"/> _{CR}	
Get :	Get the mixing level of the selected output	# MIX-LVL? <input type="checkbox"/> _{SP} P1 <input type="checkbox"/> _{CR}	
Response			
Set / Get : ~ <input type="checkbox"/> _{nn} @ MIX-LVL <input type="checkbox"/> _{SP} P1,P2 <input type="checkbox"/> _{CR LF}			
Parameters			
P1 (Output number)– 0=Audio out; 1=Scaler 1; 2=Scaler2 P2 (Level) – 0 to 100			
Response triggers			
<ul style="list-style-type: none"> • Response is sent to the com port from which the Set (before execution) / Get command was received • After execution, response is sent to all com ports if CMD-NAME was set any other external control device (button press, device menu and similar) or genlock status was changed 			
Notes			
Sets the mixing level between the audio of the selected video In and the selected AUX audio channel			

Command – Mute		Command Type – [Audio]	
Command Name		Permission	Transparency
Set:	MUTE	End User	Public
Get:	MUTE?	End User	Public
Description		Syntax	
Set:	Mute the selected output	# MUTE <input type="checkbox"/> _{SP} P1,P2 <input type="checkbox"/> _{CR}	
Get :	Mute the selected output	# MUTE? <input type="checkbox"/> _{SP} P1 <input type="checkbox"/> _{CR}	
Response			
Set / Get : ~ <input type="checkbox"/> _{nn} @ MUTE <input type="checkbox"/> _{SP} P1,P2. <input type="checkbox"/> _{CR LF}			
Parameters			
P1 – 0:0=Line out; 0:1=Monitor Out; 1=Scaler1; 2=Scaler2 P2 – 0=Off; 1=On			
Response triggers			
<p>Response is sent to the com port from which the Set (before execution) / Get command was received</p> <p>After execution, response is sent to all com ports if CMD-NAME was set any other external control device (button press, device menu and similar) or genlock status was changed</p>			
Notes			
Mutes the selected audio output			

Command – Scaler As?		Command Type – [Audio]	
Command Name		Permission	Transparency
Set:	SCLR-AS	End User	Public
Get:	SCLR-AS?	End User	Public
Description		Syntax	
Set:	Set the	# SCLR-AS <input type="checkbox"/> _{SP} P1,P2 <input type="checkbox"/> _{CR}	
Get :	Get the	# SCLR-AS? <input type="checkbox"/> _{SP} P1 <input type="checkbox"/> _{CR}	
Response			
Set / Get : ~ <input type="checkbox"/> _{nn} @ SCLR-AS <input type="checkbox"/> _{SP} P1,P2.... <input type="checkbox"/> _{CR LF}			
Parameters			
P1 –(Scaler Number)1=Scaler 1; 2=Scaler2 P2 (Off/On)– 0=Off; 1=On			
Response triggers			
Response is sent to the com port from which the Set (before execution) / Get command was received After execution, response is sent to all com ports if CMD-NAME was set any other external control device (button press, device menu and similar) or genlock status was changed			
Notes			
Sets the Auto Sync features for the selected Scaler			

Command – Image Proportions		Command Type – [Video]	
Command Name		Permission	Transparency
Set:	IMAGE-PROP	End User	Public
Get:	IMAGE-PROP?	End User	Public
Description		Syntax	
Set:	Set the image size	# IMAGE-PROP <input type="checkbox"/> _{SP} P1 <input type="checkbox"/> _{CR}	
Get :	Get the image size	# IMAGE-PROP? <input type="checkbox"/> _{SP} P1,...,P6 <input type="checkbox"/> _{CR}	
Response			
Set / Get : ~ <input type="checkbox"/> _{nn} @ IMAGE-PROP <input type="checkbox"/> _{SP} P1,P2.... <input type="checkbox"/> _{CR LF}			
Parameters			
P1 (Scaler number) –1=Scaler 1; 2=Scaler2 P2 (Status) – 0=Over Scan; 1=Full; 2=Best Fit; 3=PanScan; 3=Letter Box; 5=Under 2; 6=Under 1			
Response triggers			
Response is sent to the com port from which the Set (before execution) / Get command was received After execution, response is sent to all com ports if CMD-NAME was set any other external control device (button press, device menu and similar) or genlock status was changed			
Notes			
Sets the image properties of the selected scaler			

Command – PC Auto Sync		Command Type – [Video]	
Command Name		Permission	Transparency
Set:	SCLR-PCAUTO	End User	Public
Get:		End User	Public
Description		Syntax	
Set:	Set	# SCLR-PCAUTO <input type="checkbox"/> _{SP} P1,P2 <input type="checkbox"/> _{CR}	
Get :			
Response			
Set / Get : ~ <input type="checkbox"/> _{nn} @ SCLR-PCAUTO <input type="checkbox"/> _{SP} P1,P2... <input type="checkbox"/> _{CR LF}			
Parameters			
P1 (Scaler number) – 1=Scaler 1; 2=Scaler2 P2 (Off/On) – 0=Off; 1=On			
Response triggers			
Response is sent to the com port from which the Set (before execution) / Get command was received After execution, response is sent to all com ports if CMD-NAME was set any other external control device (button press, device menu and similar) or genlock status was changed			
Notes			
Sets the PC Auto sync of the selected scaler			

Command – Scaler Audio Delay		Command Type – [Audio]	
Command Name		Permission	Transparency
Set:	SCLR-AUDIO-DELAY	End User	Public
Get:	SCLR-AUDIO-DELAY?	End User	Public
Description		Syntax	
Set:	Set the scaler audio delay	# SCLR-AUDIO-DELAY <input type="checkbox"/> _{SP} P1,P2 <input type="checkbox"/> _{CR}	
Get :	Get the scaler audio delay	# SCLR-AUDIO-DELAY? <input type="checkbox"/> _{SP} P1 <input type="checkbox"/> _{CR}	
Response			
Set / Get : ~ <input type="checkbox"/> _{nn} @ SCLR-AUDIO-DELAY <input type="checkbox"/> _{SP} P1,P2 <input type="checkbox"/> _{CR LF}			
Parameters			
P1 (Audio output number) – 0=Audio out; 1=Scaler 1; 2=Scaler2 P2 (Level selection) – 0=Off; 1 to 8=10ms to 80ms in 10ms steps; 9=Auto			
Response triggers			
Response is sent to the com port from which the Set (before execution) / Get command was received After execution, response is sent to all com ports if CMD-NAME was set any other external control device (button press, device menu and similar) or genlock status was changed			
Notes			
Sets the audio delay for the selected audio output			

Command – Equalization Level		Command Type – [Audio]	
Command Name		Permission	Transparency
Set:	EQ-LVL	End User	Public
Get:	EQ-LVL?	End User	Public
Description		Syntax	
Set:	Set the equalization level	# EQ-LVL <input type="checkbox"/> _{SP} P1,P2,P3 <input type="checkbox"/> _{CR}	
Get :	Get the equalization level	# EQ-LVL? <input type="checkbox"/> _{SP} P1,P2 <input type="checkbox"/> _{CR}	
Response			
Set / Get : ~ <input type="checkbox"/> _{nn} @ EQ-LVL <input type="checkbox"/> _{SP} P1,P2,P3 <input type="checkbox"/> _{CR} <input type="checkbox"/> _{LF}			
Parameters			
P1 (Audio output number) – 0=Audio out; 1=Scaler 1; 2=Scaler2 P2 (frequency number) – 0=120; 1=200; 3=500; 4=1200; 5=3000; 6=7500; 8=12000 P3 (Level) – 0=-10dB 20=0dB; 40=10dB			
Response triggers			
Response is sent to the com port from which the Set (before execution) / Get command was received After execution, response is sent to all com ports if CMD-NAME was set any other external control device (button press, device menu and similar) or genlock status was changed			
Notes			
Sets the EQ level for the selected frequency of the selected audio output			

Command – Show the OSD		Command Type – [Video]	
Command Name		Permission	Transparency
Set:	SHOW-OSD	End User	Public
Get:	SHOW-OSD?	End User	Public
Description		Syntax	
Set:	Set the OSD display	# SHOW-OSD <input type="checkbox"/> _{SP} P1 <input type="checkbox"/> _{CR}	
Get :	Get the OSD display	# SHOW-OSD? <input type="checkbox"/> _{SP} <input type="checkbox"/> _{CR}	
Response			
Set / Get : ~ <input type="checkbox"/> _{nn} @ SHOW-OSD <input type="checkbox"/> _{SP} P1 <input type="checkbox"/> _{CR} <input type="checkbox"/> _{LF}			
Parameters			
P1 (Scaler number) – 0=Both Off; 1=1 On; 2=2 On; 99=Both On			
Response Triggers			
Response is sent to the com port from which the Set (before execution) / Get command was received After execution, response is sent to all com ports if CMD-NAME was set any other external control device (button press, device menu and similar) or genlock status was changed			
Notes			
Displays the OSD of the selected Scaler			

Command – Microphone Gain		Command Type – [Audio]	
Command Name		Permission	Transparency
Set:	MIC-GAIN	End User	Public
Get:	MIC-GAIN?	End User	Public
Description		Syntax	
Set:	Set the microphone gain	# MIC-GAIN <input type="checkbox"/> P1,P2 <input type="checkbox"/>	
Get :	Get the microphone gain	# MIC-GAIN? <input type="checkbox"/> P1 <input type="checkbox"/>	
Response			
Set / Get : ~ <input type="checkbox"/> @ MIC-GAIN <input type="checkbox"/> P1,P2 <input type="checkbox"/>			
Parameters			
P1 (Input number, for VP-553 always 0) = 0 P2 (level) – 0 to 100			
Response Triggers			
Response is sent to the com port from which the Set (before execution) / Get command was received After execution, response is sent to all com ports if CMD-NAME was set any other external control device (button press, device menu and similar) or genlock status was changed			
Notes			
Sets the Microphone input audio gain			

Command – DIP switch status		Command Type – [Machine]	
Command Name		Permission	Transparency
Set:		End User	Public
Get:	DPSW-STATUS?	End User	Public
Description		Syntax	
Set:			
Get :	Get the DIP-switch status	# DPSW-STATUS? <input type="checkbox"/> P1 <input type="checkbox"/>	
Response			
Get : ~ <input type="checkbox"/> @ DPSW-STATUS <input type="checkbox"/> P2 <input type="checkbox"/>			
Parameters			
P1 –0=SW 0;... 2=SW2 P2 (Off/On) – Off=0, On=1			
Response Triggers			
Response is sent to the com port from which the Set (before execution) / Get command was received After execution, response is sent to all com ports if CMD-NAME was set any other external control device (button press, device menu and similar) or genlock status was changed			
Notes			
Gets the DIP status for the selected DIP switch			

LIMITED WARRANTY

The warranty obligations of Kramer Electronics for this product are limited to the terms set forth below:

What is Covered

This limited warranty covers defects in materials and workmanship in this product.

What is Not Covered

This limited warranty does not cover any damage, deterioration or malfunction resulting from any alteration, modification, improper or unreasonable use or maintenance, misuse, abuse, accident, neglect, exposure to excess moisture, fire, improper packing and shipping (such claims must be presented to the carrier), lightning, power surges, or other acts of nature. This limited warranty does not cover any damage, deterioration or malfunction resulting from the installation or removal of this product from any installation, any unauthorized tampering with this product, any repairs attempted by anyone unauthorized by Kramer Electronics to make such repairs, or any other cause which does not relate directly to a defect in materials and/or workmanship of this product. This limited warranty does not cover cartons, equipment enclosures, cables or accessories used in conjunction with this product.

Without limiting any other exclusion herein, Kramer Electronics does not warrant that the product covered hereby, including, without limitation, the technology and/or integrated circuit(s) included in the product, will not become obsolete or that such items are or will remain compatible with any other product or technology with which the product may be used.

How Long Does this Coverage Last

Seven years as of this printing; please check our Web site for the most current and accurate warranty information.

Who is Covered

Only the original purchaser of this product is covered under this limited warranty. This limited warranty is not transferable to subsequent purchasers or owners of this product.

What Kramer Electronics will do

Kramer Electronics will, at its sole option, provide one of the following three remedies to whatever extent it shall deem necessary to satisfy a proper claim under this limited warranty:

1. Elect to repair or facilitate the repair of any defective parts within a reasonable period of time, free of any charge for the necessary parts and labor to complete the repair and restore this product to its proper operating condition. Kramer Electronics will also pay the shipping costs necessary to return this product once the repair is complete.
2. Replace this product with a direct replacement or with a similar product deemed by Kramer Electronics to perform substantially the same function as the original product.
3. Issue a refund of the original purchase price less depreciation to be determined based on the age of the product at the time remedy is sought under this limited warranty.

What Kramer Electronics will not do Under This Limited Warranty

If this product is returned to Kramer Electronics or the authorized dealer from which it was purchased or any other party authorized to repair Kramer Electronics products, this product must be insured during shipment, with the insurance and shipping charges prepaid by you. If this product is returned uninsured, you assume all risks of loss or damage during shipment. Kramer Electronics will not be responsible for any costs related to the removal or re-installation of this product from or into any installation. Kramer Electronics will not be responsible for any costs related to any setting up this product, any adjustment of user controls or any programming required for a specific installation of this product.

How to Obtain a Remedy under this Limited Warranty

To obtain a remedy under this limited warranty, you must contact either the authorized Kramer Electronics reseller from whom you purchased this product or the Kramer Electronics office nearest you. For a list of authorized Kramer Electronics resellers and/or Kramer Electronics authorized service providers, please visit our web site at www.kramerelectronics.com or contact the Kramer Electronics office nearest you.

In order to pursue any remedy under this limited warranty, you must possess an original, dated receipt as proof of purchase from an authorized Kramer Electronics reseller. If this product is returned under this limited warranty, a return authorization number, obtained from Kramer Electronics, will be required. You may also be directed to an authorized reseller or a person authorized by Kramer Electronics to repair the product.

If it is decided that this product should be returned directly to Kramer Electronics, this product should be properly packed, preferably in the original carton, for shipping. Cartons not bearing a return authorization number will be refused.

Limitation on Liability

THE MAXIMUM LIABILITY OF KRAMER ELECTRONICS UNDER THIS LIMITED WARRANTY SHALL NOT EXCEED THE ACTUAL PURCHASE PRICE PAID FOR THE PRODUCT. TO THE MAXIMUM EXTENT PERMITTED BY LAW, KRAMER ELECTRONICS IS NOT RESPONSIBLE FOR DIRECT, SPECIAL, INCIDENTAL OR CONSEQUENTIAL DAMAGES RESULTING FROM ANY BREACH OF WARRANTY OR CONDITION, OR UNDER ANY OTHER LEGAL THEORY. Some countries, districts or states do not allow the exclusion or limitation of relief, special, incidental, consequential or indirect damages, or the limitation of liability to specified amounts, so the above limitations or exclusions may not apply to you.

Exclusive Remedy

TO THE MAXIMUM EXTENT PERMITTED BY LAW, THIS LIMITED WARRANTY AND THE REMEDIES SET FORTH ABOVE ARE EXCLUSIVE AND IN LIEU OF ALL OTHER WARRANTIES, REMEDIES AND CONDITIONS, WHETHER ORAL OR WRITTEN, EXPRESS OR IMPLIED. TO THE MAXIMUM EXTENT PERMITTED BY LAW, KRAMER ELECTRONICS SPECIFICALLY DISCLAIMS ANY AND ALL IMPLIED WARRANTIES, INCLUDING, WITHOUT LIMITATION, WARRANTIES OF MERCHANTABILITY AND FITNESS FOR A PARTICULAR PURPOSE. IF KRAMER ELECTRONICS CANNOT LAWFULLY DISCLAIM OR EXCLUDE IMPLIED WARRANTIES UNDER APPLICABLE LAW, THEN ALL IMPLIED WARRANTIES COVERING THIS PRODUCT, INCLUDING WARRANTIES OF MERCHANTABILITY AND FITNESS FOR A PARTICULAR PURPOSE, SHALL APPLY TO THIS PRODUCT AS PROVIDED UNDER APPLICABLE LAW.

IF ANY PRODUCT TO WHICH THIS LIMITED WARRANTY APPLIES IS A "CONSUMER PRODUCT" UNDER THE MAGNUSON-MOSS WARRANTY ACT (15 U.S.C.A. §2301, ET SEQ.) OR OTHER APPLICABLE LAW, THE FOREGOING DISCLAIMER OF IMPLIED WARRANTIES SHALL NOT APPLY TO YOU, AND ALL IMPLIED WARRANTIES ON THIS PRODUCT, INCLUDING WARRANTIES OF MERCHANTABILITY AND FITNESS FOR THE PARTICULAR PURPOSE, SHALL APPLY AS PROVIDED UNDER APPLICABLE LAW.

Other Conditions

This limited warranty gives you specific legal rights, and you may have other rights which vary from country to country or state to state.

This limited warranty is void if (i) the label bearing the serial number of this product has been removed or defaced, (ii) the product is not distributed by Kramer Electronics or (iii) this product is not purchased from an authorized Kramer Electronics reseller. If you are unsure whether a reseller is an authorized Kramer Electronics reseller, please visit our Web site at www.kramerelectronics.com or contact a Kramer Electronics office from the list at the end of this document.

Your rights under this limited warranty are not diminished if you do not complete and return the product registration form or complete and submit the online product registration form. Kramer Electronics thanks you for purchasing a Kramer Electronics product. We hope it will give you years of satisfaction.



For the latest information on our products and a list of Kramer distributors, visit our Web site where updates to this user manual may be found.

We welcome your questions, comments, and feedback.

Web site: www.kramerelectronics.com

E-mail: info@kramerel.com



SAFETY WARNING

Disconnect the unit from the power supply before opening and servicing



P/N: 2900-300326



Rev: 2

Other ManualsLib Projects



www.manualslib.com



www.manualslib.de



www.manualslib.es



www.manualslib.fr



www.manualslib.nl



www.manualslib.mx



www.manualslib.tech 30+ Languages