



USER MANUAL

MODEL:

VS-1616DN-EM

**2x2 to 16x16 Modular Multi-Format
Managed Digital Matrix Switcher**



Contents

Introduction	1
Getting Started	2
Overview	4
Defining the VS-1616DN-EM 2x2 to 16x16 Modular Multi-Format Managed Digital Matrix Switcher	6
Mounting VS-1616DN-EM	10
Connecting the VS-1616DN-EM	11
Port Numbering	12
Connecting to the VS-1616DN-EM via RS-232	13
Connecting to the VS-1616DN-EM via USB (VCOM)	13
Connecting to the VS-1616DN-EM via Ethernet	13
Operating – Front Panel Buttons	17
Startup Display	17
Viewing the Display	18
Using the Selector Buttons	18
Confirming Actions	18
Switching Actions	19
Locking the Front Panel Buttons	22
Using the Configuration Menus	23
Using the Setup Menu	23
Using the Config Menu	27
Configuring the Number of Installed Input and Output Ports	33
Operating and Configuring – Embedded Web Pages	34
Browsing Web Pages	35
Switching – Web Pages	36
Copying EDID – Web Pages	37
Configuring Ports – Web Pages	37
Using the Test Video Plus Analog Audio Card	38
Defining the Test Video Plus Analog Audio Card	38
Setting the Resolution of the Generated Video	40
Setting the Pattern of the Generated Video	40
Installing the Test Module	41
Using the Input / Output Cards	42
Defining the UHD-IN2-F16 / UHD-OUT2-F16	42
Defining the UHDA-IN2-F16 / UHDA-OUT2-F16	44
Defining the HDBT7-IN2-F16 / HDBT7-OUT2-F16	48
Defining the DTAxr-IN2-F16 / DTAxr-OUT2-F16	51
Defining the HDBT-IN2-F16 / HDBT-OUT2-F16	55
Defining the HH-IN2-F16 / HH-OUT2-F16	59
Defining the HS-OUT2-F16	60
Defining the HAD-IN2-F16 / HAD-OUT2-F16	63
Defining the HAA-IN2-F16 / HAA-OUT2-F16	65
Defining the HDCP-IN2-F16 / HDCP-OUT2-F16	68
Defining the DGKat-IN2-F16 / DGKat-OUT2-F16	70
Defining the F670-IN2-F16 / F670-OUT2-F16	73
Defining the F610-IN2-F16 / F610-OUT2-F16	74
Defining the DVI-IN2-F16 / DVI-OUT2-F16	75
Defining the DL-IN1-F16 / DL-OUT1-F16	76
Defining the SDIA-IN2-F16	77
Defining the VGA-IN2-F16 / VGA-OUT2-F16	79
Defining the VGAA-OUT2-F16 / VGAA-IN2-F16	81
Defining the AAD-IN2-F16 / AAD-OUT2-F16	85
Defining the UHDS-OUT2-F16	87
Using the Test Module to Troubleshoot Video and Audio Problems	89
Troubleshooting Video Problems	89
Troubleshooting Audio Problems	91
Input / Output Card Hardware Installation Instructions	93
Replacing a FAN-16DN Fan Array	95

Installing a PS-16DN Power Supply	96
Upgrading the VS-1616DN-EM Firmware	97
Upgrading Firmware Using K-Upload	97
Upgrading Firmware Using Kramer Network	98
Technical Specifications	99
VS-1616DN-EM Chassis	99
Quick VS-1616DN-EM Card Comparison	100
Default Settings	102
Default Communication Parameters	102
Factory Default EDID	102
Protocol 3000	122
Understanding Protocol 3000 Commands	123
Protocol 3000 Syntax	124
Protocol 3000 Commands	124
Using the Packet Protocol	151

Introduction

Welcome to Kramer Electronics! Since 1981, Kramer Electronics has been providing a world of unique, creative, and affordable solutions to the vast range of problems that confront video, audio, presentation, and broadcasting professionals on a daily basis. In recent years, we have redesigned and upgraded most of our line, making the best even better!

Congratulations on purchasing your Kramer **VS-1616DN-EM 2x2 to 16x16 Modular Multi-Format Managed Digital Matrix Switcher**. This product, which incorporates HDMI™ technology, is ideal for:

- Professional display systems requiring video signal routing
- Broadcast, presentation and production facilities, as well as monitoring in large duplication systems
- Rental/staging applications



Throughout this user manual the chassis configuration is shown with 16 DVI inputs and 16 DVI outputs as a representation only.

The following cards are available and may be mixed in the same chassis:

- UHD-IN2-F16 / UHD-OUT2-F16
([Defining the UHD-IN2-F16 / UHD-OUT2-F16](#) on page [42](#)).
- UHDA-IN2-F16 / UHDA-OUT2-F16
([Defining the UHDA-IN2-F16 / UHDA-OUT2-F16](#) on page [44](#)).
- HDBT7-IN2-F16 / HDBT7-OUT2-F16
([Defining the HDBT7-IN2-F16 / HDBT7-OUT2-F16](#) on page [48](#)).
- DTAXr-IN2-F16 / DTAXr-OUT2-F16
([Defining the DTAXr-IN2-F16 / DTAXr-OUT2-F16](#) on page [51](#)).
- HDBT-IN2-F16 / HDBT-OUT2-F16
([Defining the HDBT-IN2-F16 / HDBT-OUT2-F16](#) on page [55](#)).
- HH-IN2-F16 / HH-OUT2-F16
(see [Defining the HH-IN2-F16 / HH-OUT2-F16](#) on page [59](#)).
- HS-OUT2-F16
([Defining the HS-OUT2-F16](#) on page [60](#)).
- HAD-IN2-F16 / HAD-OUT2-F16
([Defining the HAD-IN2-F16 / HAD-OUT2-F16](#) on page [63](#)).
- HAA-IN2-F16 / HAA-OUT2-F16
([Defining the HAA-IN2-F16 / HAA-OUT2-F16](#) on page [65](#)).
- HDCP-IN2-F16 / HDCP-OUT2-F16
([Defining the HDCP-IN2-F16 / HDCP-OUT2-F16](#) on page [68](#)).

The terms HDMI, HDMI High-Definition Multimedia Interface, and the HDMI Logo are trademarks or registered trademarks of HDMI Licensing Administrator, Inc.

- DGKat-IN2-F16 / DGKat-OUT2-F16
([Defining the DGKat-IN2-F16 / DGKat-OUT2-F16](#) on page [70](#)).
- F670-IN2-F16 / F670-OUT2-F16
([Defining the F670-IN2-F16 / F670-OUT2-F16](#) on page [73](#)).
- F610-IN2-F16 / F610-OUT2-F16
([Defining the F610-IN2-F16 / F610-OUT2-F16](#) on page [74](#)).
- DVI-IN2-F16 / DVI-OUT2-F16
([Defining the DVI-IN2-F16 / DVI-OUT2-F16](#) on page [75](#)).
- DL-IN1-F16 / DL-OUT1-F16
([Defining the DL-IN1-F16 / DL-OUT1-F16](#) on page [76](#)).
- SDIA-IN2-F16
([Defining the SDIA-IN2-F16](#) on page [77](#)).
- VGA-IN2-F16 / VGA-OUT2-F16
([Defining the VGA-IN2-F16 / VGA-OUT2-F16](#) on page [79](#)).
- VGAA-OUT2-F16 / VGAA-IN2-F16
([Defining the VGAA-OUT2-F16 / VGAA-IN2-F16](#) on page [81](#)).
- AAD-IN2-F16 / AAD-OUT2-F16
([Defining the AAD-IN2-F16 / AAD-OUT2-F16](#) on page [85](#)).
- UHDS-OUT2-F16
(see [Defining the UHDS-OUT2-F16](#) on page [87](#))



The F670-IN2/OUT2-F16 cards are fully compatible with the Kramer **670T/670R** and **671T/671R** HDMI/DVI transmitters and receivers for non-HDCP content.

Getting Started

We recommend that you:

- Unpack the equipment carefully and save the original box and packaging materials for possible future shipment.
- Review the contents of this user manual.



Go to www.kramerav.com/downloads/VS-1616DN-EM to check for up-to-date user manuals, application programs, and to check if firmware upgrades are available (where appropriate).

Achieving the Best Performance

To achieve the best performance:

- Use only good quality connection cables (we recommend Kramer high-performance, high-resolution cables) to avoid interference, deterioration in signal quality due to poor matching, and elevated noise levels (often associated with low quality cables).
- Do not secure the cables in tight bundles or roll the slack into tight coils.

- Avoid interference from neighboring electrical appliances that may adversely influence signal quality.
- Position your **VS-1616DN-EM** away from moisture, excessive sunlight and dust.

Safety Instructions



Caution:

- This equipment is to be used only inside a building. It may only be connected to other equipment that is installed inside a building.
- For products with relay terminals and GPIO ports, please refer to the permitted rating for an external connection, located next to the terminal or in the User Manual.
- There are no operator serviceable parts inside the unit.



Warning:

- Use only the power cord that is supplied with the unit.
- Disconnect the power and unplug the unit from the wall before installing.
- Do not open the unit. High voltages can cause electrical shock! Servicing by qualified personnel only.
- To ensure continuous risk protection, replace fuses only according to the rating specified on the product label which located on the bottom of the unit.

Recycling Kramer Products

The Waste Electrical and Electronic Equipment (WEEE) Directive 2002/96/EC aims to reduce the amount of WEEE sent for disposal to landfill or incineration by requiring it to be collected and recycled. To comply with the WEEE Directive, Kramer Electronics has made arrangements with the European Advanced Recycling Network (EARN) and will cover any costs of treatment, recycling and recovery of waste Kramer Electronics branded equipment on arrival at the EARN facility. For details of Kramer's recycling arrangements in your particular country go to our recycling pages at <https://www.kramerav.com/social-responsibility/environment/>.

About Fast Switching

Older display devices require a longer time between the loss of one digital signal and the introduction of another, as well as a physical disconnection of the interconnecting cable in order to be able to detect and adjust to the new video attributes and parameters. Normal switching, therefore, introduced a 5V signal disconnection along with a delay in switching. Many newer display devices, however, are now capable of accepting “on-the-fly” switching.

Depending on the display device in use, the **VS-1616DN-EM** allows for fast switching (minor reset and the connection kept alive) and extra fast switching (no reset and the connection kept alive), see [Config Menu—Setting Output Port Parameters](#) on page 29. Using the fast and extra fast switching modes allows for fraction-of-a-second switching times when using high performance display devices or when using a scaler on the video output.

About HDBaseT™ Technology

HDBaseT™ is an advanced all-in-one connectivity technology (supported by the HDBaseT Alliance). It is particularly suitable in the consumer home environment as a digital home networking alternative where it enables you to replace numerous cables and connectors by a single LAN cable used to transmit, for example, uncompressed full high definition video, audio, IR, as well as various control signals.



The products described in this user manual are HDBaseT certified.

About Power Connect™

The Power Connect™ feature here means that the **VS-1616DN-EM** can supply power to the TP transmitters and receivers (for example, the **TP-573** and **TP-574**) as long as the devices are within 90m (270ft) of each other. The Power Connect™ feature applies as long as the cable can carry power and the distance does not exceed 90m on standard CAT 5 cable. For longer distances, a heavier gauge cable should be used (a TP cable is still suitable for the video/audio transmission, but not for feeding the power at these distances).

Overview

The Kramer **VS-1616DN-EM** is a high-performance matrix switcher chassis for AV signals. The unit is modular and populated from 2 x 2 to 16 x 16 ports in increments of two inputs and/or two outputs. The unit supports various signals, depending on the type of cards installed and includes a power supply, control module and a test module that can monitor and test any input and output in the matrix. It features a very high bandwidth of up to 3.4Gbps (for the chassis only, effective bandwidth of the system depends on the input / output cards, see [Using the Input / Output Cards](#) on page 42) that ensures transparent performance even in the most critical applications. The cards re-clock and equalize the signals and the chassis can route any or all inputs to any or all outputs simultaneously.

The **VS-1616DN-EM** is highly configurable – you can add or remove inputs and outputs independently in groups of two and mix different types of input/output cards in the same chassis. For example, you can configure a device as a 4 x 12 or a 16 x 8 matrix switcher to exactly suit your needs.

The **VS-1616DN-EM** features:

- Full 16 x 16 non-blocking matrix array to switch any of the 16 input digital signals to any or all outputs (see [Connecting the VS-1616DN-EM](#) on page 11).
- Easy access to 60 pre-set memory locations for quick access to user-defined setups.
- Fast switching on outputs to reduce or remove switching delay.
- Redundant, hot swappable power supply (optional).
- Modular, easily replaceable, low-noise cooling system.
- Simple firmware upgrade of compatible devices (see [Upgrading the VS-1616DN-EM Firmware](#) on page 97).

- Seamless integration with Kramer Network for switching, card status, port status, firmware upgrades (of compatible cards), and more.
- A 40 character by 2 line LCD that shows the operational status or the configuration menu.
- A lock function to prevent tampering with the front panel.
- A default EDID (Extended Display Identification Data) for each input.
- EDID Capture – Copies and stores the EDID from a display device.
- Non-volatile EDID storage.
- Kramer Core™ – Flexible infrastructure conversion. Copper, fiber or Twisted Pair, all can be used at the same time according to input/output module selection. The matrix receives signals from compatible Kramer transmitters, automatically converts between available infrastructure options and sends the signals to compatible Kramer receivers.
- Max. Data Rate – 10.2Gbps (3.4Gbps per graphic channel) when using compatible cards.
- HDTV Compatible.
- HDCP Compliant – With DVI (HDCP), HDMI, F670, HDBaseT, HDMI with audio and DGKat modules.
- HDMI Support.
- DGKat™ Signal Integration – Kramer's unique technology for converting TMDS as well as control and communication to signals that run over twisted pair cables.



For optimum range and performance, use recommended Kramer cables, available at www.kramerav.com/product/VS-1616DN-EM.

- Kramer Equalization & re-Klocking™ Technology – Rebuilds the digital signal to travel longer distances.
- Optional Fast Switching Support – For fraction of a second switching.
- Modular & Easily Configurable Platform – Input or output module types can be mixed and added in increments of 2 from 2x2 up to 16x16.
- Versatile Selection of Modules – Including DVI, HDMI, HDCP (HDMI over DVI connector), Dual Link DVI, HDMI over Fiber, DVI over Fiber, HDBaseT, HDBaseT Lite, HDMI with analog audio interface, HDMI with digital audio interface, VGA and DGKat (HDMI over twisted pair).
- Kramer Protocol 3000.
- Flexible Configuration – To disable HDCP support and convert between HDMI and DVI.

You can operate the **VS-1616DN-EM** via the front panel buttons or remotely via:

- RS-232 or USB (VCOM) serial commands transmitted by a touch screen system, PC or other serial controller.
- Ethernet over a LAN.
- **Kramer Network** enterprise management platform.



The VS-1616DN-EM is a sophisticated device but has nevertheless been designed to be simple to operate using an intuitive front panel keypad. For details of how to route inputs to outputs, see [Switching Actions](#) on page 19.

The VS-1616DN-EM is housed in a 19" rack-mountable enclosure.

Defining the VS-1616DN-EM 2x2 to 16x16 Modular Multi-Format Managed Digital Matrix Switcher

This section defines the front and rear panels of the VS-1616DN-EM.

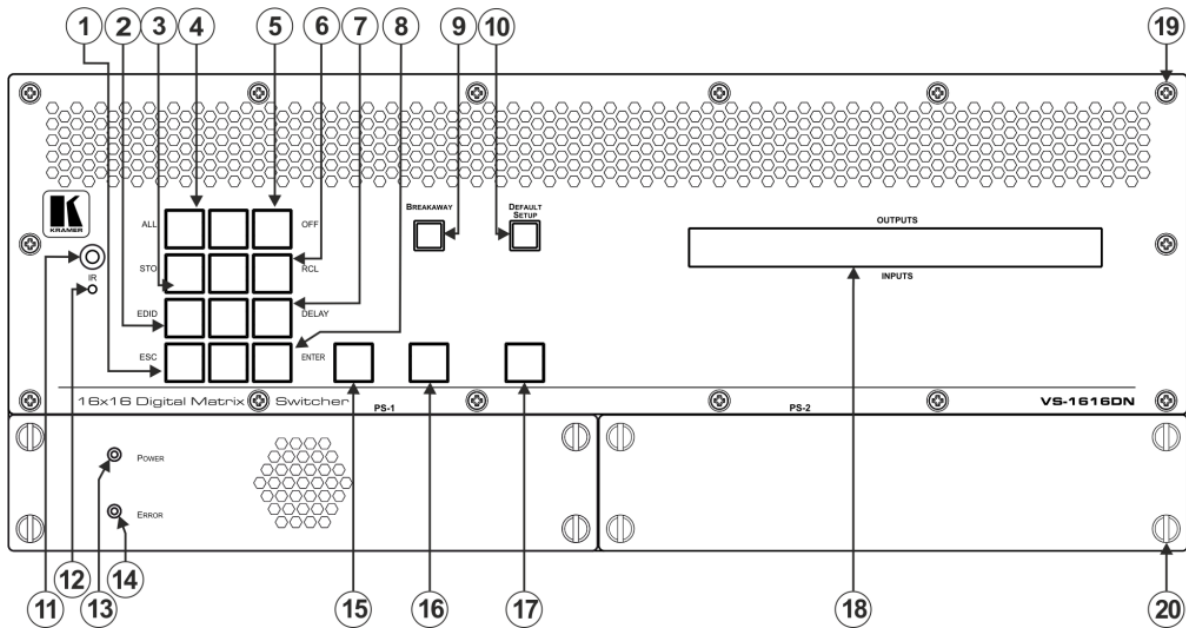

Figure 1: VS-1616DN-EM Front Panel



Buttons 15, 16 and 17 function as the TAKE, MENU and LOCK buttons respectively.

#	Feature	Function
1	Double-function Selector Buttons Area	ESC
2		EDID
3		STO
4		ALL
5		OFF
6		RCL
7		DELAY
8		ENTER
9	BREAKAWAY Button	Press to exit a Menu (see Using the Configuration Menu on page 23).

10	DEFAULT SETUP Button	Press to recall the default setup (see Recalling the Default Setup on page 21).
11	IR Receiver	Infrared remote control sensor (for future use).
12	IR LED	Lights yellow when receiving commands from the IR remote control transmitter (for future use).
13	PS-1 POWER LED	Lights green when power supply is active.
14	PS-1 ERROR LED	Lights red when an error is detected. Briefly lights red immediately following a power disruption (e.g., cable disconnection, power off, and so on).
15	TAKE Button	Press to confirm actions (see Confirming a Switching Action on page 19).
16	MENU Button	Press once to enable the ALL, OFF, STO and RCL buttons (see Using the Configuration Menu on page 23). Press again to enter the configuration menu (see Using the Config Menu on page 27). When in a Menu, press to cycle through the menu items.
17	LOCK Button	Press and hold for approximately 2 sec to lock/unlock the front panel buttons (see Locking the Front Panel Buttons on page 22).
18	OUTPUTS/INPUTS LCD Display	Displays the outputs (upper row) switched to the selected inputs (lower row), (see Startup Display on page 17). Displays user interface messages and menus.
19	Front Panel Locking Screws	Release the 14 front panel locking screws to open the front panel and access the fan arrays (see Replacing a FAN-16DN Fan Array on page 95).
20	Power Supply Thumbscrews	Release the 4 power supply thumbscrews to install / remove the PS-16DN power supply (see Installing a PS-16DN Power Supply on page 96).

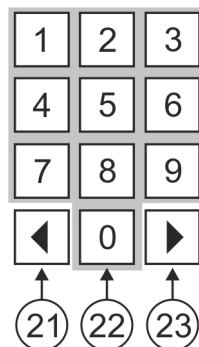

Figure 2: VS-1616DN-EM Front Panel Numeric Keypad

#	Feature	Function
21	◀ (Backward)	Press to shift the sliding window to the right (the LCD display only shows 13 cross-points out of a total of 16).
22	1, 2, 3, 4, 5, 6, 7, 8, 9, 0	Numeric keypad, 1 to 0.
23	▶ (Forward)	Press to shift the sliding window to the left (the LCD display only shows 13 cross-points out of a total of 16).

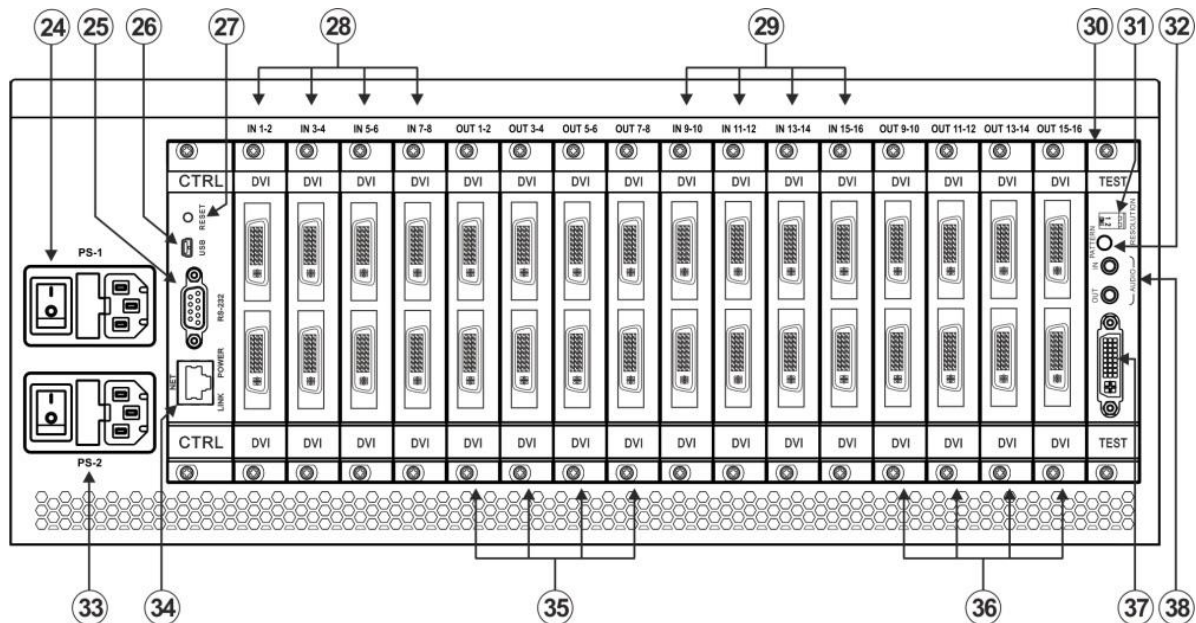

Figure 3: VS-1616DN-EM Rear Panel Showing DVI cards

#	Feature	Function
24	PS-1 AC Mains Power Module	Power supply 1: Fuse holder and power cord socket. Connect to the AC mains supply.
25	RS-232 9-pin D-sub Port	Connect to a PC or remote controller (see Connecting to the VS-1616DN-EM via RS-232 on page 13) and perform firmware upgrade of the device and compatible input/output cards (see Upgrading the VS-1616DN-EM Firmware on page 97).
26	USB Virtual COM Port USB Mini-B Connector	Connect to a PC or remote controller (see Connecting to the VS-1616DN-EM via USB (VCOM) on page 13) and perform firmware upgrade of the device and compatible input/output cards (see Upgrading the VS-1616DN-EM Firmware on page 97).
27	RESET Button	Press to restart the VS-1616DN-EM .
28	IN 1-8 Connectors	INPUTS Connect to the relevant video sources, depending on the cards installed (1 to 8, see Connecting the VS-1616DN-EM on page 11).
29	IN 9-16 Connectors	
30	TEST Module	Signal generator module for testing video and audio outputs (see Using the Test Video Plus Analog Audio Card on page 38).
31	RESOLUTION DIP-switches	Set the resolution for video generated by the Test module (see Setting the Resolution of the Generated Video on page 40).
32	PATTERN Button	Press the button repeatedly to change the video pattern generated by the Test module (see Setting the Pattern of the Generated Video on page 40).
33	PS-2 AC Mains Power Module	Power supply 2: Fuse holder and power cord socket. Connect to the AC mains supply. Only connect when a second power supply is installed in PS-2.
34	NET Ethernet RJ-45 Connector	Connect to a PC or controller via the Ethernet LAN (see Connecting to the VS-1616DN-EM via Ethernet on page 13) and perform firmware upgrade of the device and compatible input/output cards (see Upgrading the VS-1616DN-EM Firmware on page 97). LINK LED flashes when communication is active. POWER LED lights when the interface receives power.

#	Feature	Function
35	OUT 1~8 Connectors	OUTPUTS
36	OUT 9~16 Connectors	
37	Test Module DVI Molex 24-pin Video Connector	Connect to the relevant video acceptors, depending on the cards installed (1 to 8, see Connecting the VS-1616DN-EM on page 11) on page 10).
38	Test Module 3.5mm Mini Jack Unbalanced Analog Audio Connector	Connect to the relevant video acceptors, depending on the cards installed (9 to 16, see Connecting the VS-1616DN-EM on page 11).
		Connect to one of the relevant video inputs/outputs to aid in troubleshooting (see Troubleshooting Video Problems on page 89).
		Connect to one of the relevant audio inputs/outputs to aid in troubleshooting (see Troubleshooting Audio Problems on page 91).

Mounting VS-1616DN-EM

This section provides instructions for mounting **VS-1616DN-EM**. Before installing, verify that the environment is within the recommended range:



- Operation temperature – 0° to 40°C (32 to 104°F).
- Storage temperature – -40° to +70°C (-40 to +158°F).
- Humidity – 10% to 90%, RHL non-condensing.
- **VS-1616DN-EM** must be placed upright in the correct horizontal position.

**Caution:**

- Mount **VS-1616DN-EM** before connecting any cables or power.

**Warning:**

- Ensure that the environment (e.g., maximum ambient temperature & air flow) is compatible for the device.
- Avoid uneven mechanical loading.
- Appropriate consideration of equipment nameplate ratings should be used for avoiding overloading of the circuits.
- Reliable earthing of rack-mounted equipment should be maintained.

To mount the VS-1616DN-EM on a rack

Attach both ear brackets by removing the screws from each side of the machine and replacing those screws through the ear brackets or place the machine on a table.



For more information go to www.kramerav.com/downloads/VS-1616DN-EM

Connecting the VS-1616DN-EM



Always switch off the power to each device before connecting it to your **VS-1616DN-EM**. After connecting your **VS-1616DN-EM**, connect its power and then switch on the power to each device.



You do not have to connect all the inputs and outputs, connect only those that are required. In the following example, only two inputs and two outputs are connected.

The configuration of DVI input/output cards shown in [Figure 4](#) is merely a sample representation and different input / output cards may be mixed as required (for limitations, see [Port Numbering](#) on page [12](#)). Exactly the same principles apply to installations using other card types.

To connect the **VS-1616DN-EM**, as illustrated in the example in [Figure 4](#), do the following:

1. Connect up to 16 DVI video sources (for example, computer graphics sources).
2. Connect up to 16 DVI video acceptors (for example, DVI and DVI LCD displays).
3. If required, connect a PC or remote controller to the RS-232 port (see [Connecting to the VS-1616DN-EM via RS-232](#) on page [13](#)) and/or the Ethernet port (see [Connecting to the VS-1616DN-EM via Ethernet](#) on page [13](#)).
4. Connect the power cord.
5. If necessary, review and set the system configuration using the Menu (see [Using the Configuration Menu](#) on page [23](#)).



Given an input signal that is HDCP encoded, the **VS-1616DN-EM** outputs a signal only if the output port to which it is switched supports HDCP.

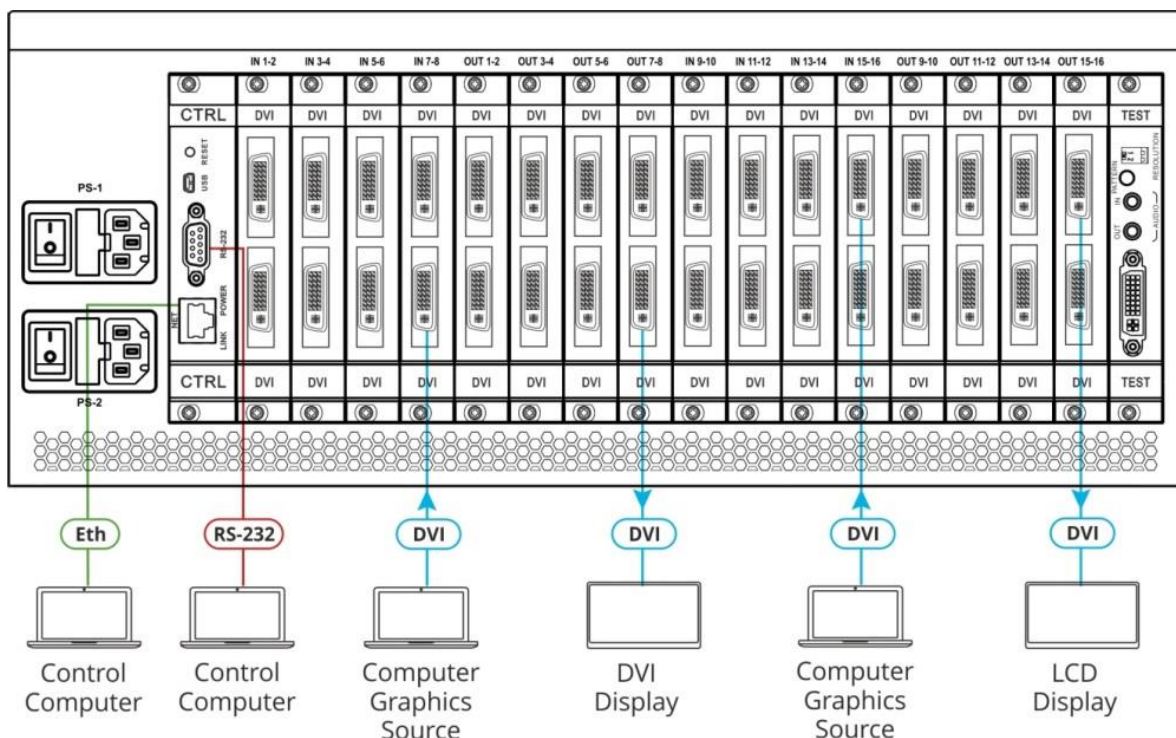

Figure 4: Connecting the VS-1616DN-EM

Port Numbering

On all cards apart from the DVI dual link cards, there are two physical ports on each card and numbering of ports is sequential from top to bottom and left to right. Each DVI dual link card provides one physical port which causes the loss of one number in the numbering sequence of that card only. A sample numbering is shown in [Figure 5](#).

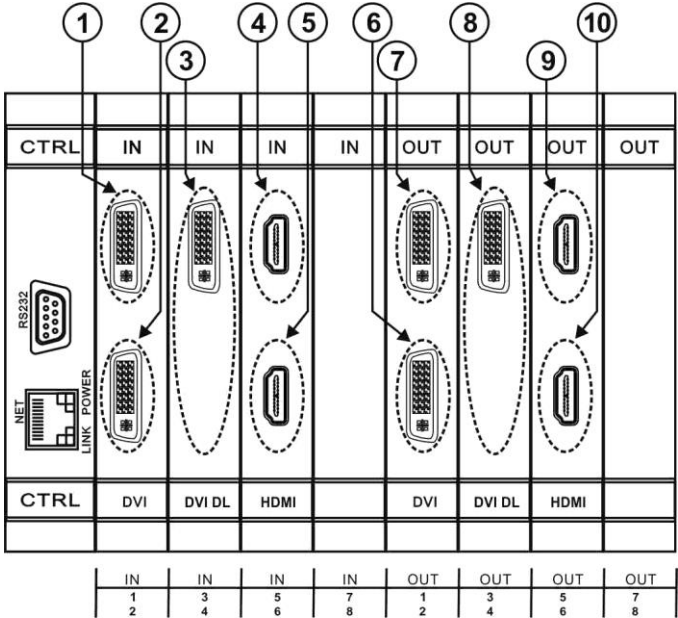

Figure 5: Sample Port Numbering

Diagram #	Actual Port Number	Diagram #	Actual Port Number
1	IN 1	6	OUT 2
2	IN 2	7	OUT 1
3	IN 3	8	OUT 3
4	IN 5	9	OUT 5
5	IN 6	10	OUT 6

i There is no IN 4 or OUT 4 because these slots contain DVI dual link cards.

EDID Numbering Examples

The following EDID configuration is based on the port numbering shown in [Figure 5](#) and lists requested switching configurations and their results.

EDID Request	EDID Sent
From OUT 4	Blank (256 bytes of 0xFF)
From IN 8	None (error message displayed)

i AV data flow is: **source** > VS-1616DN-EM > **display**. EDID information flow is: **display** > VS-1616DN-EM > **source**, which means that the EDID input is the display side and the EDID output is the AV source side. This is the reverse of the AV data flow direction.

When assigning EDIDs, note that the top row of the LCD display labeled OUTPUTS relates to the ports connected to the sources (AV inputs), and the bottom row of the LCD display labeled INPUTS relates to the ports connected to displays (AV outputs).

In [Figure 6](#), the EDID from EDID input 8 (**VS-1616DN-EM** Output port 8) has been assigned to all EDID outputs (**VS-1616DN-EM** Input ports).

OUTPUTS									
01	02	03	04	05	06	07	08	09	10
08	08	08	08	08	08	08	08	08	08
INPUTS									

Figure 6: EDID Numbering Assignment

Connecting to the VS-1616DN-EM via RS-232

You can connect to the **VS-1616DN-EM** via an RS-232 connection using, for example, a PC. Note that a null-modem adapter/connection is not required.

To connect to the VS-1616DN-EM via RS-232:

- Connect the RS-232 9-pin D-sub rear panel port on the **VS-1616DN-EM** unit via a 9-wire straight cable (only pin 2 to pin 2, pin 3 to pin 3, and pin 5 to pin 5 need to be connected) to the RS-232 9-pin D-sub port on your PC.

Connecting to the VS-1616DN-EM via USB (VCOM)

The device's USB port can work as a virtual COM (VCOM) port. Verify that the USB port on the PC that connects to the **VS-1616DN-EM** is configured as a VCOM port. You may need to install a driver to do this. You can use a tool such as Hercules or K-Config to use Protocol 3000 commands over USB (see [Protocol 3000](#) on page [122](#)). You can also use K-Upload to upgrade firmware over USB (see [Upgrading Firmware Using K-Upload](#) on page [97](#)).

Connecting to the VS-1616DN-EM via Ethernet

You can connect to the **VS-1616DN-EM** via Ethernet using either of the following methods:

- Directly to the PC using a crossover cable (see [Connecting the Ethernet Port Directly to a PC](#) on page [14](#)).
- Via a network hub, switch, or router, using a straight-through cable (see [Connecting the Ethernet Port via a Network Hub](#) on page [16](#)).



If you want to connect via a router and your IT system is based on IPv6, speak to your IT department for specific installation instructions.

Connecting the Ethernet Port Directly to a PC

You can connect the Ethernet port of the **VS-1616DN-EM** directly to the Ethernet port on your PC using a crossover cable with RJ-45 connectors.



This type of connection is recommended for identifying the **VS-1616DN-EM** with the factory configured default IP address.

After connecting the **VS-1616DN-EM** to the Ethernet port, configure your PC as follows:

1. Click **Start > Control Panel > Network and Sharing Center**.
2. Click **Change Adapter Settings**.
3. Highlight the network adapter you want to use to connect to the device and click **Change settings of this connection**.

The Local Area Connection Properties window for the selected network adapter appears as shown in [Figure 7](#).

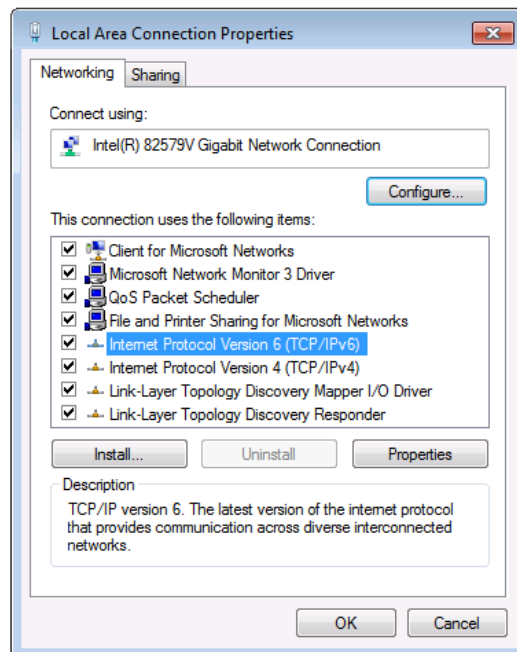

Figure 7: Local Area Connection Properties Window

4. Highlight either **Internet Protocol Version 6 (TCP/IPv6)** or **Internet Protocol Version 4 (TCP/IPv4)** depending on the requirements of your IT system.
5. Click **Properties**.

The Internet Protocol Properties window relevant to your IT system appears as shown in [Figure 8](#) or [Figure 9](#).

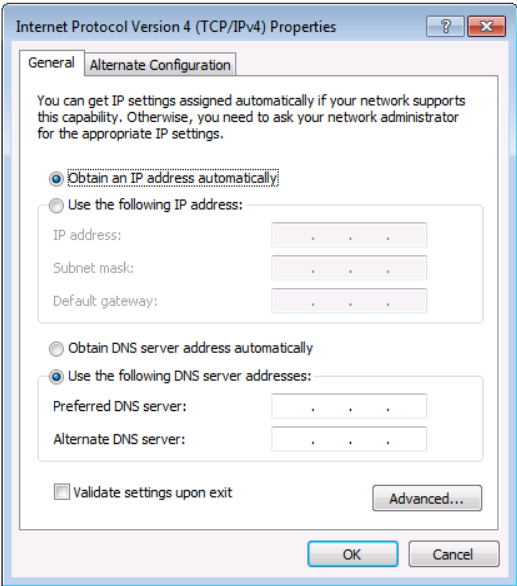

Figure 8: Internet Protocol Version 4 Properties Window

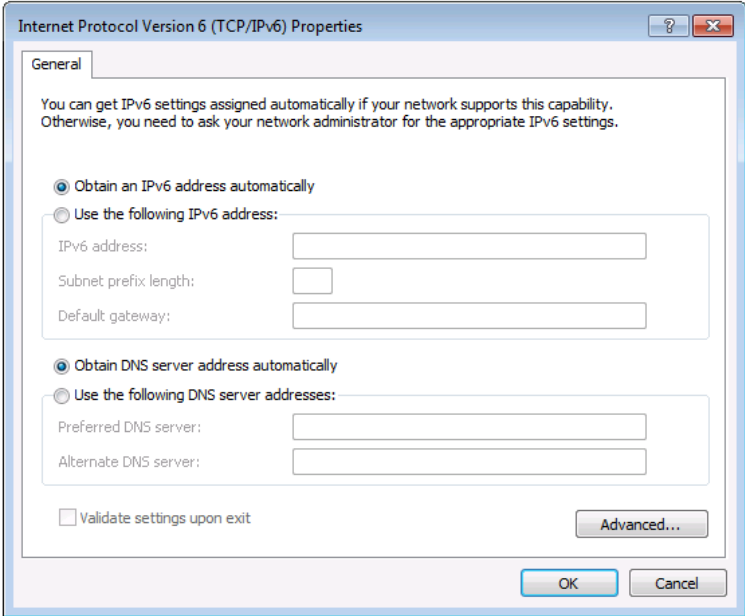

Figure 9: Internet Protocol Version 6 Properties Window

- 6. Select **Use the following IP Address** for static IP addressing and fill in the details as shown in [Figure 10](#).

For TCP/IPv4 you can use any IP address in the range 192.168.1.1 to 192.168.1.255 (excluding 192.168.1.39) that is provided by your IT department.

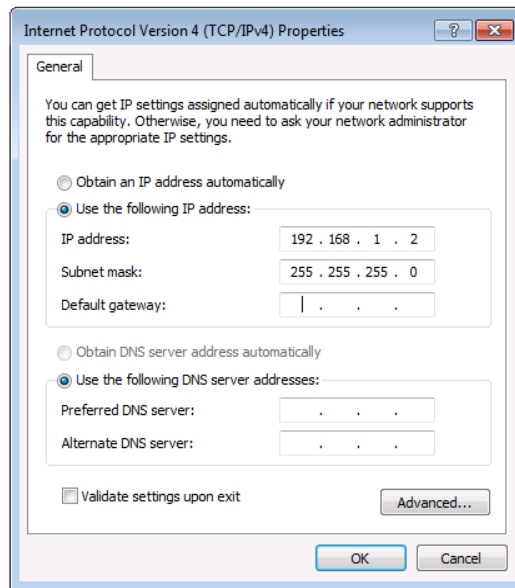

Figure 10: Internet Protocol Properties Window

7. Click **OK**.
8. Click **Close**.

Connecting the Ethernet Port via a Network Hub or Switch

You can connect the Ethernet port of the **VS-1616DN-EM** to the Ethernet port on a network hub or using a straight-through cable with RJ-45 connectors.

Operating – Front Panel Buttons

This section describes:

- The startup display (see [Startup Display](#) on page 17).
- Using the selector buttons (see [Using the Selector Buttons](#) on page 18).
- Confirming actions (see [Confirming Actions](#) on page 18).
- Switching options (see [Switching Actions](#) on page 19).
- Locking the front panel (see [Locking the Front Panel Buttons](#) on page 22).



You can also operate the device using the embedded web pages (see [Operating and Configuring – Embedded Web Pages](#) on page 34).

Startup Display

After switching on the power, the LCD display shows the following screens in sequence (text in the LCD Display may vary according to machine settings).

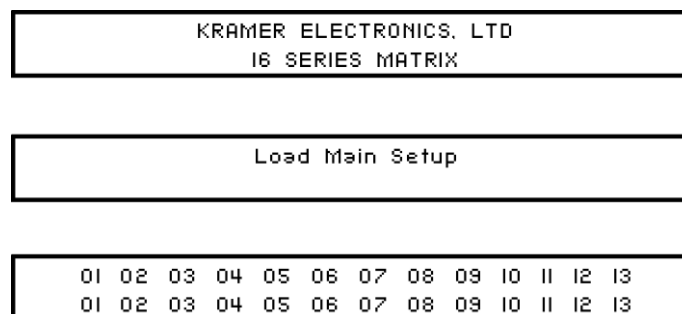

Figure 11: Default Startup Status Display Sequence

The **VS-1616DN-EM** does not have separate output and input buttons. Instead, the front panel includes a numeric keypad within the Selector Buttons area (see [Defining the VS-1616DN-EM 2x2 to 16x16 Modular Multi-Format Managed Digital Matrix Switcher](#) on page 6). This numeric keypad lets you enter both the output and input numbers as well as various numeric configuration values (see [Using the Selector Buttons](#) on page 18).

When the unit is powered-on, the last matrix setup that was used is loaded. Use either the setup recall (records a stored configuration from a preset, see [Setup Menu—6: recall setup](#) on page 26) or default setup recall (for quick retrieval of a commonly used programmable default setup, see [Recalling the Default Setup](#) on page 21) functions to retrieve other setups.

Viewing the Display

[Figure 11](#) shows the output-input matrix on the LCD display. The LCD display can show only 13 out of the 16 available matrix combinations at once. To view any of the matrix combinations use the ◀ or the ▶ buttons on the front panel to shift the sliding window to the right or left.

This sliding window functionality is enabled when:

- The switcher is in between operations (waiting for its next operation while all previous operations are complete or cancelled)
- Recalling a setup using the ◀ or ▶ buttons



When entering an output/input combination, the contents of the LCD display automatically shift to indicate the current status of the selected output.

Using the Selector Buttons

For numbers between 1 and 9, the **VS-1616DN-EM** can handle two digit numbers as well as single digit numbers. When entering a single digit number (for example 5), you can either press 0 followed by 5, or 5 followed by ENTER.

Pressing 00 (or 0, ENTER) is only relevant for an input and is used to disconnect the currently entered output number from the input.

For example, the following display indicates that outputs 8 and 12 are disconnected from any input (note that the corresponding inputs in the second line are blank):

```

06  07  08  09  10  11  12  13
12  08           10  14  13         06

```

The ESC button is used to cancel an operation without affecting the current status. For example, if you enter an incorrect number by mistake, press the ESC button to cancel the operation.



At any stage, if no button is pressed within approximately 15 seconds, the automatic timeout causes the **VS-1616DN-EM** to exit the operation and revert to the output/input display.

Confirming Actions

You can choose to work in the At Once (default, for all actions except storing/recalling) or the Confirm mode.

In the At Once mode:

- The TAKE button does not light.
- Pressing an OUT-IN combination implements the switch without further user confirmation.

- You save time as execution is immediate and actions require no user confirmation.
- No protection is offered to correct an erroneous action.
- In the Confirm mode:
 - The TAKE button lights.
 - You enter an action and then confirm it by pressing the TAKE button.
 - Every action requires user confirmation, protecting against erroneous actions.
 - Execution is postponed until you confirm the action.



Failure to press the TAKE button within a few seconds results in the action timing out automatically.

Toggling Between the At Once and Confirm Modes

To toggle between the At Once and Confirm modes:



If the TAKE button is flashing, you cannot toggle between the At Once and Confirm modes. A flashing TAKE button indicates that an action is currently pending confirmation.

1. Press TAKE to toggle between the At Once mode and the Confirm mode.
The TAKE button lights and actions now require user confirmation.
2. Press the lit TAKE button to toggle from the Confirm mode back to the At Once mode.
The TAKE button is no longer lit and actions no longer require user confirmation.

Confirming a Switching Action

Actions only require confirmation when the device is in the Confirm mode.

To confirm a switching action:

1. Using the numeric keypad, enter an output-input combination.
The TAKE button flashes.
2. Press the flashing TAKE button to confirm the action.
The action is confirmed and the TAKE button lights.

Switching Actions

This section describes how to:

- Switch one input to one output (see [Switching One Input to One Output](#) on page 20).
- Switch several inputs to several outputs (see [Switching Several Inputs to Several Outputs](#) on page 20).
- Turn off several outputs (see [Turning an Output Off](#) on page 21).

Switching One Input to One Output

To switch one input to one output:

- Using the numeric keypad, enter the required output (in this example, 12).
The following is displayed:

```
06 07 08 09 10 11 12 13
In__ => Out 12
```

The left-hand side of the display shows a section of the output/input display automatically sliding the content to include output 12.

- Using the numeric keypad, enter the required input (in this example, 14):
 - In the At Once mode, the switching takes place immediately and the LCD display shows a segment of the input-output status that includes the switched input and output (for example, 14-12)

In the Confirm mode, the LCD display shows the following:

```
In 14 => Out 12
```

Incomplete actions time out after approximately 15 seconds.

- In the Confirm mode, press the flashing TAKE button to switch the input to the output

Switching Several Inputs to Several Outputs

If you want to switch several inputs to several outputs you must be in the Confirm mode.

In the Confirm mode you can enter a batch of several actions and then confirm the batch by pressing TAKE once (simultaneously switching several output-input combinations).

To switch several inputs to several outputs in the Confirm mode:

- Using the numeric keypad, enter an output-input combination.
The TAKE button flashes.
- Enter additional output-input combinations.
The LCD display can show up to five pending actions (although the batch is not limited to five actions), as follows:

```
09 => 06    05 => 07
```

In this example, input 9 is set to switch to output 6 and input 5 is set to switch to output 7.

- After entering all output/input combinations, press the flashing TAKE button to confirm the actions.
The inputs switch to the respective outputs as shown on the LCD display and the TAKE LED is lit.

Turning an Output Off

Turning an output off means that there is no input switched to this output. This is indicated on the display by the Input being blank underneath the relevant Output.

To turn an output off:

1. Press MENU.
The Menu buttons light and are enabled.
2. Press OFF (3) on the numeric keypad (see [Figure 2](#)).
The following message is displayed:
`out__ => OFF`
3. Use the numeric keypad to turn the required output off.
The output is turned off.

To turn an output off in the Confirm mode:

- Repeat the steps above and then press the flashing TAKE button to confirm the action.

Alternatively, you can perform a switching operation (see [Switching One Input to One Output](#) on page [20](#)) and set the input to 00.

Turning Off Several Outputs

To turn off several outputs in the Confirm mode, repeat the switching actions described in [Switching Several Inputs to Several Outputs](#) on page [20](#) but set the inputs to 00.

Recalling the Default Setup

You can store a commonly used setup as the default setup (see [Config Menu—Store Default Setup](#) on page [30](#)) which can be recalled at any time.



This is not the setup that is loaded when the unit is turned on. When the unit is turned on, the setup that was last used before the unit was turned off is loaded.

To recall the default setup:

1. Press DEFAULT SETUP.
The DEFAULT SETUP button flashes and the following message is displayed:
`recall DEFAULT setup
press FLASHING button to confirm`
2. Press DEFAULT SETUP.
The following message is displayed:
`all Setups and Connections change
press TAKE to confirm`
The TAKE button flashes.
3. Press TAKE.
The default setup is recalled and the display reverts to the output-input display.

Locking the Front Panel Buttons

You can lock the **VS-1616DN-EM** to prevent tampering with the unit or prevent the settings from being changed accidentally via the front panel buttons. When the front panel is locked, you can still remotely operate the **VS-1616DN-EM** via RS-232 or Ethernet.

To lock the front panel buttons:

- Press and hold LOCK until the button lights.
The front panel buttons are locked.

To unlock the front panel buttons:

- Press and hold LOCK until the button is no longer lit.
The front panel buttons are unlocked.

Using the Configuration Menus

The configuration menus on the OUTPUTS/INPUTS LCD display let you configure the VS-1616DN-EM to best suit your needs. There are two configuration menus:

- Setup Menu—those that are accessed on a regular basis (for example, storing setups and setting the delay), see [Using the Setup Menu](#) on page 23.
- Config Menu—those that are accessed only occasionally (for example, setting the interface or communication protocol), see [Using the Config Menu](#) on page 27.

The following rules apply to the menu operation:

- If no selection is made within approximately 15 seconds, the operation times-out and the display reverts to the output/input display.
- At any point in the Menu, press ESC to move up one level or press BREAKAWAY to exit the Menu altogether.
- At any point in the Menu, only buttons that are active light or flash.

All the procedures in this section assume that you are starting the procedure from the standard, operational output/input display.

Using the Setup Menu

The Setup Menu provides access to settings that are regularly changed and comprises the following options:

- **1: inXX=>ALL**, switching one input to all outputs (see [Setup Menu—1: inXX=>ALL](#) on page 23).
- **3: outXX=OFF**, turning off an output (see [Setup Menu—3: outXX=>OFF](#) on page 24).
- **7: EDID**, assignment to an output (see [Setup Menu—7: EDID](#) on page 24).
- **9: Delay** setting for an output (see [Setup Menu—9: Delay](#) on page 25).
- **4: store setup XX**, storing the setup in a preset (see [Setup Menu—4: store setup](#) on page 26).
- **6: recall setup XX**, recalling a preset (see [Setup Menu—6: recall setup](#) on page 26).

Setup Menu—1: inXX=>ALL, Switching One Input to all Outputs

This option switches one input to all outputs.

To switch one input to all outputs:

1. Press MENU.
The Setup Menu options are displayed.

2. Press 1 (ALL) on the numeric keypad (see [Figure 2](#)).
The following is displayed:
`in__ => ALL`
3. Using the numeric keys, enter the input to be switched to all outputs.
The TAKE button flashes.
4. Press TAKE.
The selected input is switched to all outputs. The display reverts to the output/input display showing that the selected input is switched to all outputs.

Setup Menu—3: outXX=>OFF, Turning an Output Off

This option turns an output off.

To turn an output off:

1. Press MENU.
The Setup Menu options are displayed.
2. Press 3 (OFF) on the numeric keypad (see [Figure 2](#)).
The following is displayed:
`out__ => OFF`
3. Using the numeric keys, enter the output to be turned off.
The TAKE button flashes.
4. Press TAKE.
The selected output is turned off. The display reverts to the output/input display showing that the selected output is turned off with the input being blank.

Setup Menu—7: EDID, Assignment to an Input

This option assigns an EDID to between one and eight inputs in non-volatile storage. More than eight EDID assignments must be assigned in multiple batches.

Each input on the **VS-1616DN-EM** has a factory default EDID loaded (see [Factory Default EDID](#) on page [102](#)). The EDID for each input can be changed independently via the menu (described below) or by uploading an EDID binary file to each input via the RS-232 port.



It is necessary to have a display/device connected to the output from which you want to read the EDID. Failure to do so results in the default EDID being written to storage.

To assign an EDID to between one and eight inputs:

1. Press MENU.
The Setup Menu options are displayed.
2. Press 7 (EDID) on the numeric keypad (see [Figure 2](#)).
The following is displayed:
`SETUP EDID`
`ENTER to View EDID and Set EDID`
3. Press ENTER.
The current EDID matrix configuration is displayed.

- Using the numeric keys, enter the input in which to store the EDID (in this example, 08), and enter the output (in this example, 05) from which to read the EDID.

The following is displayed:

```
01 02 03 04 05 06 07 08
                                05 out05 => in08
```

The TAKE button flashes.

- Repeat Step 4 for up to eight inputs.
- Press TAKE.
The EDID is stored and passed through to the input.
The display reverts to the output/input display.

To view the EDID assignments:

- Press MENU.
The Setup Menu options are displayed.
- Press 7 (EDID) on the numeric keypad (see [Figure 2](#)).
The following is displayed:

```
SETUP EDID
ENTER to View EDID and Set EDID
```
- Press ENTER.
The current EDID matrix configuration is displayed. In this example, input 07 is assigned to output 05, all other EDID values are default.

```
05 06 07 08 09 10
      05
```

Setup Menu—9: Delay, Setting for an Output

This option sets the time delay for an output which lapses between entering a switching action and the execution of the action. This delay can be set for each output independently. The delay is defined in units of 200ms and ranges from 0 to 15, providing delays of between 0 and 3 seconds (15 x 200ms = 3 seconds).

To set the execution delay for an output:

- Press MENU.
The Setup Menu options are displayed.
- Press 9 (DELAY) on the numeric keypad (see [Figure 2](#)).
The output/delay times display is shown.
- Using the numeric keys, enter the output (in this example, 03).
The following is displayed:

```
01 02 03 04 05 06 07 08
                                DLY__ =>out03
```

- Using the numeric keys, enter the number of delay units.
- Press TAKE.
The selected output delay is set. The display reverts to the output/input display.

Setup Menu—4: store setup XX, Storing the Setup in a Preset

This option stores the current setup in a preset (1 to 60).

To store the current setup in a preset:

1. Press MENU.
The Setup Menu options are displayed.
2. Press 4 (STO) on the numeric keypad (see [Figure 2](#)).
The following is displayed:

```
store => __
```

3. Using the numeric keys, enter the preset (1 to 60) in which to store the current setup.
The following is displayed:

```
Wait ....
```

After a few seconds, if the preset is not empty, the following is displayed:

```
SETUP NOT EMPTY  
CONFIRM
```

The TAKE button flashes.

4. Press TAKE.
The setup is stored in the selected preset for subsequent recall. The display reverts to the output/input display.

Setup Menu—6: recall setup XX, Recalling a Preset

This option recalls a stored configuration from a preset (1 to 60).

To recall a stored configuration:

1. Press MENU.
The Setup Menu options are displayed.
2. Press 6 (RCL) on the numeric keypad (see [Figure 2](#)).
The following is displayed:

```
recall <= __
```

3. Using the numeric keys, enter the preset (in this example, 02) to recall.
The following is displayed:

```
Wait ....
```

After a few seconds, the following is displayed on the right hand side:

```
CONFIRM  
RECALL <= 02
```

The TAKE button flashes.

4. Press TAKE.
The preset is recalled. The display reverts to the output/input display.

Using the Config Menu

The Config Menu provides access to configuration settings that are not regularly changed and comprises the following options:

- Input signal detection display ([Config Menu—Input Signal Detection](#) on page [27](#)).
- Input port parameter setting ([Config Menu—Setting Input Port Parameters](#) on page [28](#)).
- Output load detection display (see [Config Menu—Output Load Detection Display](#) on page [29](#)).
- Output port parameter setting ([Config Menu—Setting Output Port Parameters](#) on page [29](#)).
- Storing the default setup ([Config Menu—Store Default Setup](#) on page [30](#)).
- Total matrix reset ([Config Menu—Total Matrix Reset](#) on page [31](#)).
- Display firmware versions ([Config Menu—Display Firmware Versions](#) on page [32](#)).

To enter the Config Menu:

- Press MENU twice. The MENU button lights and the following message is displayed:

```
Start configuration menu
MENU to view setups ENTER to change them
```

When browsing through the configuration menu, enabled buttons light or flash.

Use the Config Menu as follows:

1. Press the MENU button to cycle through the menu items.
The LCD display shows the current status of the selected menu item.
2. Press the ENTER button to enter a submenu.
3. After entering a submenu, you can select between several options.
Select an option by pressing one of the illuminated buttons in the Selector Buttons area.
4. After selecting the desired option, a description of the desired change is displayed and the TAKE button flashes.
5. Press the flashing TAKE button to confirm the change.
A description of the current state is displayed for about one second. The unit automatically switches to the next item in the menu.

Config Menu—Input Signal Detection Display

This option displays a list of inputs and indicates on which of them signals have been detected.

To display a list of inputs that have detected signals:

1. Press MENU twice.
The following message is displayed:

```
start configuration menu
MENU to view setup ENTER to change them
```

2. Press MENU.

The following is displayed:

```
IN:   01  02  03  04  05  06  07  08  09  10  11
OUT:  o   X   o   o   o   o   X   o   o   o   X
```

o indicates that a signal is detected and X indicates that no signal is detected on the relevant input.

3. Do one of the following:

- Press BREAKAWAY to exit the Config Menu.
- Wait approximately 15 seconds for the operation to time out.
- Press MENU to move to the next Config Menu option.

Config Menu—Setting Input Port Parameters

This option sets input port-specific parameters. Ports that show an X have no parameters available to modify. Ports that show an o have parameters available to modify. The parameters that are available, such as, audio balance, depend on the type of card installed and whether the card is an input or an output card (see [Using the Input / Output Cards](#) on page 42 for information on the input / output cards and their parameters).

To set parameters for a port:

1. Press MENU twice.

The following message is displayed:

```
start configuration menu
MENU to view setup ENTER to change them
```

2. Press MENU until a display is shown similar to the following:

```
IN:   01  02  03  04  05  06  07  08  09  10  11
SET:  X   X   X   X   o   o   X   X   o   o   X
```

X indicates that there are no modifiable parameters for the associated port and o indicates that there are modifiable parameters for the associated port.

3. Press TAKE to enter the list of ports.

The cursor flashes on a selected port.

4. Select the required port using the left and right arrow buttons.

5. Press TAKE to enter the parameters list.

A message similar to the following is displayed with the relevant port number in place of 06:

```
IN:   06
SET:  Reset Input
```

6. To select the next parameter press the right arrow button (see [Using the Input / Output Cards](#) on page 42 for available parameters).

Or:

7. To enter the selected parameter press TAKE.

The parameter options are displayed.

8. Select the required action or number using the keypad numbers and arrows.
9. Press TAKE to save the change.



The parameter change is not implemented on the system until you press TAKE.

10. Repeat from Step 6 to modify additional parameters.
11. Do one of the following:
 - Press BREAKAWAY to exit the Config Menu.
 - Wait approximately 15 seconds for the operation to time out.
 - Press MENU to exit to the parameter list.

Config Menu—Output Load Detection Display

This option displays a list of outputs and indicates which have loads attached to them.

To display a list of outputs and attached loads:

1. Press MENU twice.

The following message is displayed:

```
start configuration menu
MENU to view setup ENTER to change them
```

2. Press MENU until the following is displayed:

```
OUT:   01  02  03  04  05  06  07  08  09  10  11
LOAD:  o   X   o   o   o   o   X   o   o   o   X
```

o indicates that a load is attached and X indicates that no load is detected on the relevant output.

3. Do one of the following:
 - Press BREAKAWAY to exit the Config Menu
 - Wait approximately 15 seconds for the operation to time out
 - Press MENU to move to the next Config Menu option

Config Menu—Setting Output Port Parameters

This option sets port-specific parameters. Ports that show an X have no parameters available to modify. Ports that show an o have parameters available to modify. The parameters that are available, such as, audio balance, depend on the type of card installed and whether the card is an input or an output card. Tables listing output cards and their parameters can be found at the end of this section.

To set parameters for a port:

1. Press MENU twice.

The following message is displayed:

```
start configuration menu
MENU to view setup ENTER to change them
```

2. Press MENU until a display is shown similar to the following:

```
OUT:  01  02  03  04  05  06  07  08  09  10  11
SET:  o   o   X   X   o   o   o   o   X   X   X
```

X indicates that there are no modifiable parameters for the associated port and o indicates that there are modifiable parameters for the associated port.

3. Press TAKE to enter the list of ports.
The cursor flashes on a selected port.

4. Select the required port to modify using the left and right arrow buttons.

5. Press TAKE to enter the parameters list.

A message similar to the following is displayed with the relevant port number in place of 06:

```
OUT: 06
SET: Reset SubBoard
```

6. To select the next parameter press the right arrow button (see [Using the Input / Output Cards](#) on page 42 for available parameters).

Or:

7. To enter the displayed parameter press TAKE.
The parameter options are displayed.

8. Select the required action or number using the keypad numbers and arrows.

9. Press TAKE to save the change.



The parameter change is not implemented on the system until you press TAKE.

10. Repeat from Step 6 to modify other parameters.

11. Do one of the following:

- Press BREAKAWAY to exit the Config Menu.
- Wait approximately 15 seconds for the operation to time out.
- Press MENU to exit to the parameter list.

Config Menu—Store Default Setup

This option lets you store the current setup as the default setup. The default setup can be recalled at any time using the DEFAULT SETUP button (see [Recalling the Default Setup](#) on page 21).



This is not the setup that is loaded when the unit is switched on.

To store the current setup as the default setup:

1. Press MENU twice.

The following message is displayed:

```
start configuration menu
MENU to view setup ENTER to change them
```

2. Press MENU until the following is displayed:

```
store DEFAULT setup
press ENTER to store
```

3. Press ENTER to store the current configuration as the default configuration.

The following is displayed:

```
current matrix stage is OKAY?
press TAKE to confirm
```

4. Press TAKE.

The following is displayed:

```
current matrix stage
store as DEFAULT setup
```

This indicates that the current setup is stored as the default setup. After a few seconds the next option on the Config Menu is displayed.

Config Menu—Total Matrix Reset

This option lets you turn all outputs off or reset the unit to its factory default settings.

To reset the matrix setup:

1. Press MENU twice.

The following message is displayed:

```
start configuration menu
MENU to view setup ENTER to change them
```

2. Press MENU until the following is displayed:

```
TOTAL MATRIX RESET
ESC: exit    ENTER = submenu
```

3. Press ENTER to enter the Reset Submenu.

The following is displayed:

```
COMPLETELY MATRIX RESET
1:ALL outputs OFF  2:Factory default
```

4. Press 1 to turn off all outputs or 2 to perform a factory reset of all options.



Selecting option 2 to perform a factory default reset clears all setups, options and configuration.

5. Press TAKE and wait a few seconds.

The following is displayed:

```
Are you Absolutely sure !!!
Once more TAKE to confirm
```

6. Press TAKE.

The following is displayed:

```
Matrix erased!!!
Please, wait ...
```

The matrix and device configuration are erased. After a few seconds the next option on the Config Menu is displayed.

Config Menu—Display Firmware Versions

This option displays the main and front firmware versions.

To display the firmware versions:

1. Press MENU twice.

The following message is displayed:

```
start configuration menu  
MENU to view setup ENTER to change them
```

2. Press MENU until the following is displayed:

```
Main Firmware Version:      5.0  
Front Firmware Version:    5.0
```

3. Either:

- Press BREAKAWAY to exit the Config Menu.
- Wait approximately 15 seconds for the operation to time out.

Configuring the Number of Installed Input and Output Ports

After installing or removing a module you can set the number of input and output ports so that the VS-1616DN-EM displays only the installed modules. Refer to [Port Numbering](#) on page 12 for an explanation of port numbering before setting the number of input and output ports.

To set the number of input or output ports:

1. Press ESC, ENTER and LOCK together.

The following is displayed:

```
Configuration Device
```

2. Press ENTER.

The following is displayed:

```
Test Board: 1 MaxInput:17 MaxOutput:17
```



The number of input and output ports can only be set in units of two, for example, 4 x 4, 16 x 4 or 12 x 16.

3. Using the numeric keys, enter the number of input and output ports installed.
The TAKE button flashes.
4. Press TAKE.
The number of installed ports is saved and the display reverts to the output/input display.
5. Reboot the device by turning the power off and then on again.



If you customized the number of displayed ports before installing a new module, you may need to re-customize the displayed ports to reflect your hardware change.

Operating and Configuring – Embedded Web Pages

VS-1616DN-EM enables you to operate and configure the device via Ethernet using built-in, user-friendly web pages.



You can also operate and configure **VS-1616DN-EM** via Protocol 3000 API commands (see [Protocol 3000 Commands](#) on page [124](#)) and via the front panel buttons (see [Operating – Front Panel Buttons](#) on page [17](#) and [Using the Configuration Menus](#) on page [23](#)).

VS-1616DN-EM embedded web pages enable you to do the following:

- [Browsing Web Pages](#) on page [35](#).
- [Switching – Web Pages](#) on page [36](#).
- [Copying EDID – Web Pages](#) on page [37](#).
- [Configuring Ports – Web Pages](#) on page [37](#).

Browsing Web Pages



If a web page does not update correctly, clear your Web browser's cache.

To browse the web pages:

1. Connect to **VS-1616DN-EM** via Ethernet (see [Connecting to the VS-1616DN-EM via Ethernet](#) on page [13](#)).
2. Type the IP address of the device in the address bar of your internet browser (default = 192.168.1.39).

If security is enabled, the Login window appears.

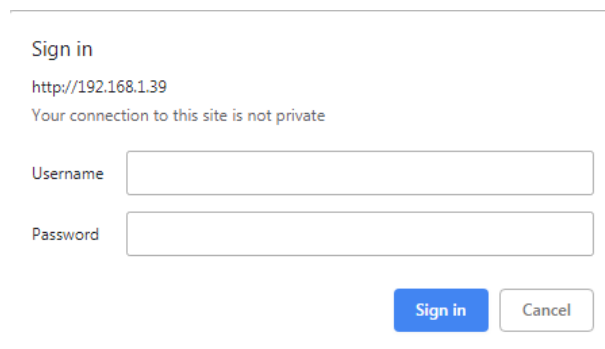
A screenshot of a web browser's login window. The window has a title bar and contains the following elements: the text "Sign in" at the top; the URL "http://192.168.1.39" below it; a warning message "Your connection to this site is not private"; two input fields labeled "Username" and "Password"; and two buttons at the bottom right, "Sign in" (highlighted in blue) and "Cancel".

Sign in
http://192.168.1.39
Your connection to this site is not private
Username
Password
Sign in Cancel

Figure 12: Embedded Web Pages Login Window

3. Enter the Username (default = Admin) and Password (default = Admin) and click **Sign in**.

The default web page appears.

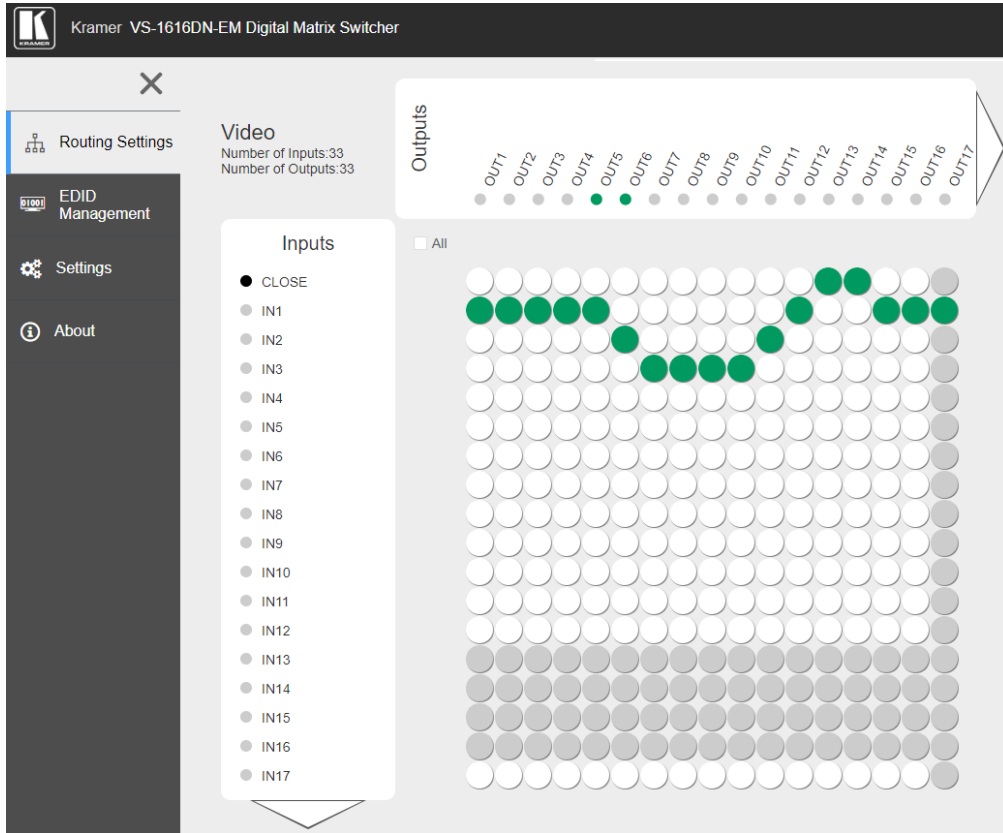

Figure 13: Default Page with Navigation Pane

4. Click the Navigation Pane on the left side of the screen to access the relevant web page.



Click the X next to the navigation pane to hide the names of the pages and the menu icon to show the names of the pages.

Switching – Web Pages

VS-1616DN-EM enables you to switch inputs to outputs using the embedded web pages.

VS-1616DN-EM web pages enable you to do the following:

- [Switching Video – Web Pages](#) on page [36](#).
- [Turning Off Outputs – Web Pages](#) on page [37](#).

Switching Video – Web Pages

VS-1616DN-EM enables you to switch video signals from inputs to outputs using the embedded web pages.

To switch video using the embedded web pages:

1. Go to the Routing Settings page.
The Routing Settings page opens.
2. Click the circle that intersects the input and output that you want to switch.
The selected circle turns green, and the video input is switched to the output.

Turning Off Outputs – Web Pages

VS-1616DN-EM enables you to turn off outputs, so that they are not connected to any input.

To turn off an output:

1. Go to the Routing Settings page.
2. Click the circle in the CLOSE row that corresponds to the output that you want to turn off.

The selected output is turned off.

Copying EDID – Web Pages

VS-1616DN-EM enables you to copy an EDID from any input or output to any input using the embedded web pages.

To copy an EDID:

1. Go to the EDID Management page.
2. Click an input or output in the **Read From** area.

-OR-

Click **DEFAULT** to use the default EDID.

3. Click all relevant Inputs in the **Copy to** area.



Select the **All** checkbox to copy to all inputs.

4. Click **COPY**.
The selected EDID is copied to all selected inputs.

Configuring Ports – Web Pages

VS-1616DN-EM enables you to configure settings for each input or output on a module card that is installed into the chassis.

To configure settings for a port:

1. On the Port tab of the Settings page, click the relevant port from the Port List.
The Information panel for the selected port appears.
2. Configure settings as needed.

Using the Test Video Plus Analog Audio Card

Defining the Test Video Plus Analog Audio Card

The **Test Video Plus Analog Audio** card is a 2-Input/Output DVI with Analog Audio Card (F-16), preinstalled in the **VS-1616DN-EM** for initial setup and installation purposes (see [Figure 3](#) for more information). For information on using the **Test Video Plus Analog Audio** card for troubleshooting audio and video problems, see [Using the Test Module to Troubleshoot Video and Audio Problems](#) on page [89](#).



Test Video Plus Analog Audio Card Configuration

The **Test Video Plus Analog Audio** card configuration table appears as follows when configured as an input card:

Test Video Plus Analog Audio Input Card		
Parameter	Description	Default
Reset Input	Re-power—Power cycles the port. Factory—Performs a factory reset to default values of the port.	Re-power
Audio Select	Selects the audio source: Auto—Audio signal selection is controlled by the presence or absence of a plug in the 3.5mm mini jack. When present, AUD-Analog is selected, when absent, AUD-Embedded is selected. AUD-Embedded—HDMI audio is selected. AUD-Analog—Analog audio is selected.	Auto
Volume	Sets the audio output volume (0–70). Note: Not applicable when digital audio is selected.	50
Audio Balance	Sets the audio output channel balance (0–100). Note: Not applicable when digital audio is selected.	50
Audio Bass	Sets the audio output bass level (0–15). Note: Not applicable when digital audio is selected.	7
Audio Treble	Sets the audio output treble level (0–15). Note: Not applicable when digital audio is selected.	7
Audio Mute	MUTE—Mutes the audio input. Non-MUTE—Unmutes the audio input. Note: Not applicable when digital audio is selected.	Non-MUTE

The **Test Video Plus Analog Audio** card configuration table appears as follows when configured as an output card:

Test Video Plus Analog Audio Output Card		
Parameter	Description	Default
Reset Output	Re-power—Power cycles the port. Factory—Performs a factory reset to default values of the port.	Re-power
HDMI	Sets the output signal format (Display, HDMI, DVI). Display—the output is set automatically based on the EDID of the connected display. HDMI—Force the output to be HDMI. DVI—Force the output to be DVI. Note: When selecting the DVI option, verify that the input signal originates as RGB or that you convert it to RGB in the input card's Color Space menu – if the EDID dictates RGB color space, copy an EDID that allows RGB only and not YcBcR. When selecting the DVI option and fast switching is enabled, you must ensure that the source is DVI compatible.	Display
Switch Speed	When switching between different sources the switching time can be reduced by setting the fast switch level (Ex-fast Switch, Fast Switch or Normal Switch).	Normal Switch
Audio Mute	MUTE—Mutes the audio input. Non-MUTE—Unmutes the audio input.	Non-MUTE
Volume	Sets the audio output volume (0–70).	50
Audio Balance	Sets the audio output channel balance (0–100).	50
Audio Bass	Sets the audio output bass level (0–15).	7
Audio Treble	Sets the audio output treble level (0–15).	7
Audio Mono	OFF— Analog output is stereo. MIX— Analog output is mono.	OFF

Test Video Plus Analog Audio Card Technical Specifications

The following table defines the technical specifications.

PORTS:	1 DVI-D on a DVI Molex 24-pin (F) connector 2 unbalanced analog audio on 3.5mm mini jack connectors
BANDWIDTH PER CHANNEL:	2.25Gbps
TOTAL BANDWIDTH:	6.75Gbps
3D PASS THROUGH:	Not Supported
POWER CONSUMPTION:	5W
OPERATING TEMPERATURE:	0° to +40°C (32° to 104°F)
STORAGE TEMPERATURE:	–40° to +70°C (–40° to 158°F)
HUMIDITY:	10% to 90%, RHL non-condensing
DIMENSIONS:	19cm x 13cm x 2cm (7.5" x 5.1" x 0.8") W, D, H
PRODUCT WEIGHT:	0.15 kg (0.33 lbs) approx.
SHIPPING WEIGHT:	0.3 kg (0.66 lbs) approx.
STANDARD COMPLIANCE:	HDCP 1.4
SAFETY REGULATORY COMPLIANCE:	CE, FCC
ENVIRONMENTAL REGULATORY COMPLIANCE:	Complies with appropriate requirements of RoHs and WEEE

Setting the Resolution of the Generated Video

The test module generates a range of both PC and HD resolutions which are selected by a combination of DIP-switches and an on-board jumper (labeled #1). Install the jumper to select HD resolutions or remove the jumper to select PC resolutions.

The Resolution DIP-switch is used to set the resolution of the generated video:

Available PC Resolutions for Generated Video (Jumper Off)		
DIP-switch Position		Resolution
1	2	
OFF	OFF	1024 x 768 @60Hz
ON	OFF	1280 x 1024 @60Hz
OFF	ON	1600 x 1200 @60Hz
ON	ON	1920 x 1200 @60Hz

Available HD Resolutions for Generated Video (Jumper On, Default)		
DIP-switch Position		Resolution
1	2	
OFF	OFF	480p (default)
ON	OFF	720p
OFF	ON	1080i
ON	ON	1080p

[Figure 14](#) shows the Resolution DIP-switch with both switches off (up, default, 480p).



Figure 14: Resolution DIP-switch

Setting the Pattern of the Generated Video

The Pattern button is used to set the pattern of generated video. There are 32 available patterns. Press the button repeatedly to cycle through the patterns.

Installing the Test Module

By default, the test module is installed in the configuration. If you uninstalled the test module in the configuration, it must be reinstalled before it can be used. When installing the test module, the number of configured inputs and outputs must be increased by one. For example:

- If your **VS-1616DN-EM** has four inputs and eight outputs, you must configure the **VS-1616DN-EM** as 5 x 9
- If your **VS-1616DN-EM** has 16 inputs and 16 outputs, you must configure the **VS-1616DN-EM** as 17 x 17

To install the test module in the configuration:

1. Press ESC, ENTER and LOCK together.
The following is displayed:

```
Configuration Device
```

2. Press ENTER.
The following is displayed:

```
Test Board: 0 MaxInput:16 MaxOutput:16
```

where 0 indicates that the test module is not installed.

3. Using the numeric keys, press 1 to indicate that the test module is installed.
The TAKE button flashes.
4. Press TAKE.
5. Increase the number of configured inputs and outputs by one (see [Configuring the Number of Installed Input and Output Ports](#) on page 33).
6. Power cycle the device.
The test module is now installed and may be used.

Using the Input / Output Cards

This section defines the input / output cards and their relevant parameters.

Configuration information in this section refers to menus of the OUTPUTS/INPUTS LCD display on the front panel of the matrix. For information about configuring input / output cards from the embedded web pages, see [Configuring Ports – Web Pages](#) on page 37.



Not all options are displayed for every menu selection. Some parameters depend on the specific selection of other parameters.

The volume control provides only attenuation, not gain. Hence, setting volume to 100% provides 0 attenuation.

Defining the UHD-IN2-F16 / UHD-OUT2-F16

The **UHD-IN2-F16** is a two-channel 4K60 4:2:0 HDMI input card. The UHD-IN2-F16 inputs two HDMI signals into the chassis:



The **UHD-OUT2-F16** is a two-channel 4K60 4:2:0 HDMI output card. The **UHD-OUT2-F16** outputs two HDMI signals from the chassis:



The **UHD-IN2-F16** and **UHD-OUT2-F16** cards feature:

- ARC support.
- EDID Capture - Copies and stores the EDID from a display device.
- Kramer Equalization and re-Klocking™ Technology.

UHD-IN2-F16 / UHD-OUT2-F16 Configuration

The **UHD-IN2-F16** configuration table appears as follows:

UHD-IN2-F16 Input Card		
Parameter	Description	Default
HDCP	Turn HDCP on and off. *0=EN, 1=DIS. Note: Analog audio is still transmitted when HDCP is disabled.	0
Reset Input	Re-power: power cycles the port. Factory: performs a factory reset to default values of the port.	Re-power

The **UHD-OUT2-F16** configuration table appears as follows:

UHD-OUT2-F16 Output Card		
Parameter	Description	Default
Switch Speed	When switching between different sources the switching time can be reduced by setting the fast switch level (Fast Switch or Normal Switch).	Normal Switch
Reset Output	Re-power: power cycle the port. Factory default: perform a factory reset of the port to default values.	Re-power

UHD-IN2-F16 / UHD-OUT2-F16 Technical Specifications

The following table defines the technical specifications.

PORTS:	2 HDMI
BANDWIDTH PER CHANNEL:	2.97Gbps per graphics channel
TOTAL BANDWIDTH:	8.91Gbps data rate
MAXIMUM RANGE:	10m (32ft) – 4K60 4:2:0 or 4K30 4:4:4 15m (49ft) – 1080p 12 bit (deep color)
3D PASS THROUGH:	Supported
HDMI SUPPORT:	3D, Deep Color, x.v.Color™, ARC, Dolby® TrueHD, Dolby Digital Plus, DTS-HD®, 7.1 multi-channel audio
POWER CONSUMPTION:	Input card: 3.7W Output card: 4W
OPERATING TEMPERATURE:	0° to +40°C (32° to 104°F)
STORAGE TEMPERATURE:	–40° to +70°C (–40° to 158°F)
HUMIDITY:	10% to 90%, RHL non-condensing
DIMENSIONS:	19cm x 13cm x 2cm (7.5" x 5.1" x 0.8") W, D, H
PRODUCT WEIGHT:	0.23 kg (0.51 lbs) approx.
SHIPPING WEIGHT:	0.37 kg (0.82 lbs) approx.
STANDARD COMPLIANCE:	HDCP 1.4, HDTV compatible
SAFETY REGULATORY COMPLIANCE:	CE
ENVIRONMENTAL REGULATORY COMPLIANCE:	Complies with appropriate requirements of RoHs and WEEE

Defining the **UHDA-IN2-F16** / **UHDA-OUT2-F16**

The **UHDA-IN2-F16** is a two-channel 4K60 4:2:0 HDMI with analog audio input card. The **UHDA-IN2-F16** inputs two HDMI signals to the chassis with optional embedding/de-embedding of unbalanced stereo audio to/from each HDMI port on the card:



The **UHDA-OUT2-F16** is a two-channel 4K60 4:2:0 HDMI with analog audio output card. The **UHDA-OUT2-F16** outputs two HDMI signals from the chassis with optional de-embedding/embedding of unbalanced stereo audio to/from each HDMI port on the card:



The **UHDA-IN2-F16** and **UHDA-OUT2-F16** cards feature:

- Analog audio embedding/de-embedding on the same jack and ARC on the upper port.
- EDID capture: Copies and stores the EDID from a display device.
- Kramer Equalization and re-Klocking™ technology.



When a multi-channel audio input signal is routed to a card with stereo analog audio outputs, the analog audio out connectors output the front right and front left audio channels only.

Each audio jack enables audio insertion/extraction only to/from its corresponding HDMI port.

UHDA-IN2-F16 / UHDA-OUT2-F16 Configuration

The **UHDA-IN2-F16** configuration table appears as follows:

UHDA-IN2-F16 Input Card		
Parameter	Description	Default
Volume	Sets the audio output volume (0–70). Note: Not applicable when digital audio is selected.	50
Audio Balance	Sets the audio output channel balance (0–100). Note: Not applicable when digital audio is selected.	50
Audio Bass	Sets the audio output bass level (0–15). Note: Not applicable when digital audio is selected.	7
Audio Treble	Sets the audio output treble level (0–15). Note: Not applicable when digital audio is selected.	7
Audio Mute	MUTE: mutes the audio input. Non-MUTE: unmutes the audio input. Note: Not applicable when digital audio is selected.	Non-MUTE
Audio Select	AUD-Digital: Digital audio is selected. AUD-Analog: Analog audio from the 3.5mm mini jack is selected.	AUD-Digital
ST	Selects the manner in which the analog audio port functions. 0=Input. If an analog source is connected, the port acts as an input and embeds the audio into the HDMI signal that goes to the matrix. 1=Output. The audio is de-embedded from the HDMI source and is output as analog audio. (Note: The 3.5mm mini jack connector acts as an output in this case!) 2=ARC. The audio is taken from the 3.5mm mini jack connector and sent to the ARC device which is connected to the HDMI input.	0
HDCP	Turn HDCP on and off. *0=EN, 1=DIS. Note: Analog audio is still transmitted when HDCP is disabled.	0
Reset Input	Re-power: power cycles the port. Factory: performs a factory reset to default values of the port.	Re-power

The **UHDA-OUT2-F16** configuration table appears as follows:

UHDA-OUT2-F16 Output Card		
Parameter	Description	Default
Volume	Sets the audio output volume (0–70).	50
Audio Balance	Sets the audio output channel balance (0–100).	50
Audio Bass	Sets the audio output bass level (0–15).	7
Audio Treble	Sets the audio output treble level (0–15).	7
Audio Mute	MUTE: mutes the audio output. Non-MUTE: unmutes the audio output. Note: When set to Mute, any change to the audio parameters automatically sets this to unmute.	Non-MUTE
Audio Mono	OFF—Analog output is stereo. MIX—Analog output is mono.	OFF
ST	Selects the manner in which the analog audio port functions. 0=Input. If an analog source is connected, the 3.5mm mini jack connector acts as an input and embeds the audio into the HDMI output signal. 1=Output. The audio is de-embedded from the HDMI signal routed to this card, and is output as analog audio with the 3.5mm mini jack connector acting as an output. 2=ARC. The audio is taken from the sink that supports ARC and is output as analog audio on the 3.5mm mini jack connector.	1
Switch Speed	When switching between different sources the switching time can be reduced by setting the fast switch level (Fast Switch or Normal Switch).	Normal Switch
Reset Output	Re-power: power cycle the port. Factory default: perform a factory reset of the port to default values.	Re-power

UHDA-IN2-F16 / UHDA-OUT2-F16 Technical Specifications

The following table defines the technical specifications.

PORTS:	2 HDMI 2 Analog audio on 3.5mm mini jacks
BANDWIDTH PER CHANNEL:	2.97Gbps
TOTAL BANDWIDTH:	8.91Gbps
MAXIMUM RANGE:	10m (32ft) – 4K60 4:2:0 or 4K30 4:4:4 15m (49ft) – 1080p 12 bit (deep color)
3D PASS THROUGH:	Supported
HDMI SUPPORT:	3D, Deep Color, x.v.Color™, ARC, Dolby® TrueHD, Dolby Digital Plus, DTS-HD®, 7.1 multi-channel audio
POWER CONSUMPTION:	Input card: 5.2W Output card: 5.5W
OPERATING TEMPERATURE:	0° to +40°C (32° to 104°F)
STORAGE TEMPERATURE:	–40° to +70°C (–40° to 158°F)
HUMIDITY:	10% to 90%, RHL non-condensing
DIMENSIONS:	19cm x 13cm x 2cm (7.5" x 5.1" x 0.8") W, D, H
PRODUCT WEIGHT:	0.23 kg (0.51 lbs) approx.
SHIPPING WEIGHT:	0.37 kg (0.82 lbs) approx.
STANDARD COMPLIANCE:	HDCP 1.4, HDTV compatible
SAFETY REGULATORY COMPLIANCE:	CE,
ENVIRONMENTAL REGULATORY COMPLIANCE:	Complies with appropriate requirements of RoHs and WEEE

Defining the HDBT7-IN2-F16 / HDBT7-OUT2-F16

The **HDBT7-IN2-F16** is a 2-Input 4K60 4:2:0 HDMI over HDBaseT card (F-16). The **HDBT7-IN2-F16** inputs two HDBaseT signals with bidirectional RS-232 and IR from the line to the chassis:

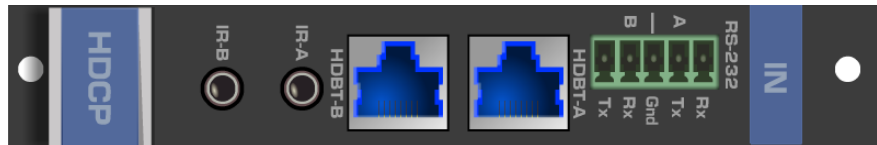

The **HDBT7-OUT2-F16** is a 2-Output 4K60 4:2:0 HDMI over HDBaseT card (F-16). The **HDBT7-OUT2-F16** outputs two HDBaseT, bidirectional RS-232 and IR signals from the chassis to the line:

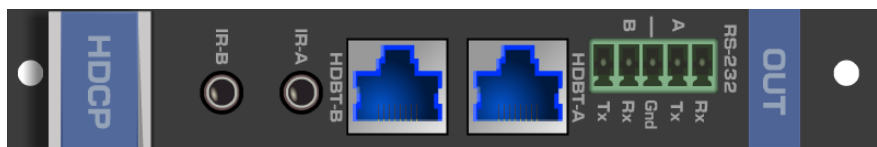

The **HDBT7-IN2-F16** and **HDBT7-OUT2-F16** cards feature Kramer Equalization and re-Klocking™ technology. The cards include a 3.5mm jack for connecting an IR emitter, such as the **C-A35M/IRE**, or an IR receiver, such as the **C-A35M/IRRN**. The **HDBT7-IN2-F16** and **HDBT7-OUT2-F16** cards also include a terminal block for connecting via RS-232. For information on connecting via RS-232, see [Connecting to the VS-1616DN-EM via RS-232](#) on page [13](#).

HDBT7-IN2-F16 / HDBT7-OUT2-F16 Configuration

The **HDBT7-IN2-F16** configuration table appears as follows:

HDBT7-IN2-F16 Input Card		
Parameter	Description	Default
Reset Input	Re-power: power cycle the port. Factory default: perform a factory reset of the port to default values.	Re-power
HDCP	Turn HDCP on and off. *0=EN, 1=DIS.	0

The **HDBT7-OUT2-F16** configuration table appears as follows:

HDBT7-OUT2-F16 Output Card		
Parameter	Description	Default
HDMI	Sets the output signal format (Display, HDMI, DVI). Display—the output is set automatically based on the EDID of the connected display. HDMI—Force the output to be HDMI. DVI—Force the output to be DVI. Note: When selecting the DVI option, verify that the input signal originates as RGB or that you convert it to RGB in the input card's Color Space menu – if the EDID dictates RGB color space, copy an EDID that allows RGB only and not YcBcR. When selecting the DVI option and fast switching is enabled, you must ensure that the source is DVI compatible.	Display
Reset Output	Re-power: power cycle the port. Factory default: perform a factory reset of the port to default values.	Re-power
Switch Speed	When switching between different sources the switching time can be reduced by setting the fast switch level (Ex-fast Switch, Fast Switch or Normal Switch).	Normal Switch

HDBT7-IN2-F16 / HDBT7-OUT2-F16 Technical Specifications



HDBT cards must be used with twisted pair cables with RJ-45 connections, such as Kramer **BC-UNIKAT** shielded twisted pair (U/FTP) cables.

The following table defines the technical specifications.

PORTS:	2 HDBaseT TP on RJ45 connectors 2 RS-232 Serial ports on a 10-pin terminal block 2 IR ports on 3.5mm jacks
BANDWIDTH PER CHANNEL:	Video: 3.4Gbps Serial Data: 115200
TOTAL BANDWIDTH:	Video: 10.2Gbps Serial Data: 115200
MAXIMUM RANGE:	40m (130ft) – 4K @60Hz 4:2:0 or 4K @30Hz 4:4:4 70m (230ft) – 1080p 12 bit (deep color)
3D PASS THROUGH:	Supported
POWER CONSUMPTION:	Input card: 10W Output card: 8W
OPERATING TEMPERATURE:	0° to +40°C (32° to 104°F)
STORAGE TEMPERATURE:	–40° to +70°C (–40° to 158°F)
HUMIDITY:	10% to 90%, RHL non-condensing
DIMENSIONS:	19cm x 13cm x 2cm (7.5" x 5.1" x 0.8") W, D, H
PRODUCT WEIGHT:	0.16 kg (0.35 lbs) approx.
SHIPPING WEIGHT:	0.35 kg (0.77 lbs) approx.
STANDARD COMPLIANCE:	HDBaseT, HDTV compatible
SAFETY REGULATORY COMPLIANCE:	CE
ENVIRONMENTAL REGULATORY COMPLIANCE:	Complies with appropriate requirements of RoHs and WEEE
INCLUDED ACCESSORIES:	Screwdriver

Defining the DTAxr-IN2-F16 / DTAxr-OUT2-F16

The **DTAxr-IN2-F16** is a 2-input 4K60 4:2:0 HDMI over HDBaseT card with selectable embedded or de-embedded analog audio (F-16). The **DTAxr-IN2-F16** inputs two extended reach HDBaseT signals with analog audio, bidirectional RS-232, and IR from the line to the chassis.

The **DTAxr-IN2-F16** inputs two HDBaseT signals to the chassis with optional embedding/de-embedding of unbalanced stereo audio to/from each HDBT port on the card:

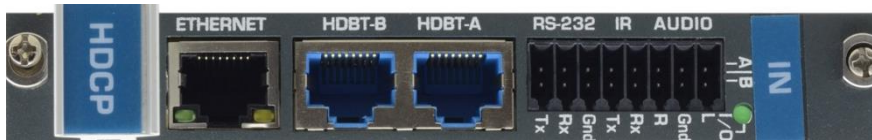

The **DTAxr-OUT2-F16** is a 2-output 4K60 4:2:0 HDMI over HDBaseT card with selectable embedded or de-embedded analog audio (F-16). The **DTAxr-OUT2-F16** outputs two extended reach HDBaseT signals with analog audio, bidirectional RS-232, and IR from the chassis to the line.

The **DTAxr-OUT2-F16** outputs two HDBaseT signals from the chassis with optional de-embedding/embedding of unbalanced stereo audio to/from each HDBT port on the card:

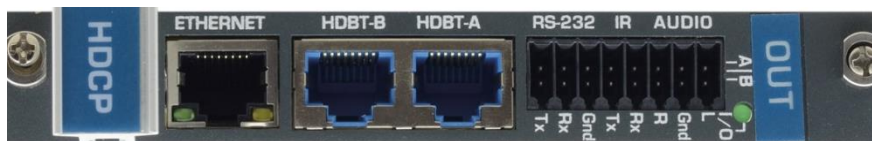

The **DTAxr-IN2-F16** and **DTAxr-OUT2-F16** cards include a terminal block for connecting analog audio, RS-232, an IR emitter, such as the **C-A35M/IRE**, or an IR receiver, such as the **C-A35M/IRRN**. For information on the IR wiring scheme, see [IR Wiring Scheme for HDBT Cards](#) on page 58. For information on connecting via RS-232, see [Connecting to the VS-1616DN-EM via RS-232](#) on page 13.



When a multi-channel audio input signal is routed to a card with stereo analog audio outputs, the analog audio out connectors output the front right and front left audio channels only.

Each audio jack enables audio insertion/extraction only to/from its corresponding HDMI port.

DTAxr-IN2-F16 / DTAxr-OUT2-F16 Configuration

The **DTAxr-IN2-F16** configuration table appears as follows:

DTAxr-IN2-F16 Input Card		
Parameter	Description	Default
Audio Select	AUD-Embedded—HDMI audio is selected. AUD-Analog—Analog audio from the 16-pin terminal block is selected. Note: Not applicable when the audio port is set to output (ST=1).	AUD-Embedded
ST	Sets the direction of the audio port: 0—Audio is set to input 1—Audio is set to output Note: This parameter affects both audio ports on the card. The direction of the audio signal is indicated by the I/O LED above the terminal block: ON—Audio is set to input OFF—Audio is set to output	0
HDCP	Turn HDCP on and off. *0=EN, 1=DIS.	0
XTRA	Enables range extender. Off for distances of up to 100m at 4K@60Hz 4:2:0 or 4K@30Hz 4:4:4 or up to 130m at 2K; On for distances of up to 180m at 1080p @60Hz @24bpp. *0:ON, 1:OFF. Note: Distances are valid when using Kramer BC-UNIKAT cables.	1
Reset Input	Re-power: power cycle the port. Factory Reset: perform a factory reset of the port to default values.	Re-power
Volume	Sets the audio output volume (0–70). Note: Not applicable when digital audio is selected.	50
Audio Balance	Sets the audio output channel balance (0–100). Note: Not applicable when digital audio is selected.	50
Audio Bass	Sets the audio output bass level (0–15). Note: Not applicable when digital audio is selected.	7
Audio Treble	Sets the audio output treble level (0–15). Note: Not applicable when digital audio is selected.	7
Audio Mute	MUTE—Mutes the audio input. Audio is unmuted if any of the audio parameters are modified. Non-MUTE—Unmutes the audio input. Note: Not applicable when digital audio is selected.	Non-MUTE

The **DTAxr-OUT2-F16** configuration table appears as follows:

DTAxr-OUT2-F16 Output Card		
Parameter	Description	Default
Volume	Sets the audio output volume (0–70). Note: Not applicable when digital audio is selected.	50
Audio Balance	Sets the audio output channel balance (0–100). Note: Not applicable when digital audio is selected.	50
Audio Bass	Sets the audio output bass level (0–15). Note: Not applicable when digital audio is selected.	7
Audio Treble	Sets the audio output treble level (0–15). Note: Not applicable when digital audio is selected.	7
Audio Mute	MUTE—Mutes the audio input. Audio is unmuted if any of the audio parameters are modified. Non-MUTE—Unmutes the audio input. Note: Not applicable when digital audio is selected.	Non-MUTE
Audio Mono	OFF—Analog output is stereo. MIX—Analog output is mono. Note: Not applicable when digital audio is selected.	OFF
ST	Sets the direction of the audio port: 0—Audio is set to input 1—Audio is set to output Note: This parameter affects both audio ports on the card. The direction of the audio signal is indicated by the I/O LED above the terminal block: ON—Audio is set to input OFF—Audio is set to output	1
Switch Speed	When switching between different sources the switching time can be reduced by setting the fast switch level (Fast Switch or Normal Switch).	Normal Switch
Reset Output	Re-power: power cycle the port. Factory default: perform a factory reset of the port to default values.	Re-power
XTRA	Enables range extender. Off for distances of up to 100m at 4K@60Hz 4:2:0 or 4K@30Hz 4:4:4 or 130m at 2K; On for distances of up to 180m at 1080p @60Hz @24bpp. *0:ON, 1:OFF, 2:AUTO. Note: Distances are valid when using Kramer BC-UNIKAT cables.	2
Audio Select	AUD-Embedded—HDMI audio is selected. AUD-Analog—Analog audio from the 16-pin terminal block is selected. Note: Not applicable when the audio port is set to output (ST=1).	AUD-Embedded

DTA_{xr}-IN2-F16 / DTA_{xr}-OUT2-F16 Technical Specifications



HDBT cards must be used with twisted pair cables with RJ-45 connections, such as Kramer **BC-UNIKAT** shielded twisted pair (U/FTP) cables.

The following table defines the technical specifications.

PORTS:	2 HDBaseT TP on RJ45 connectors 2 RS-232 Serial ports, 2 IR ports, and 2 analog audio ports on a 16-pin terminal block 1 Ethernet port on an RJ-45 connector
BANDWIDTH PER CHANNEL:	Video: 3.4Gbps Serial Data: 115200
TOTAL BANDWIDTH:	Video: 10.2Gbps Serial Data: 115200
MAXIMUM RANGE:	100m (330ft) – 4K @60Hz 4:2:0 or 4K @30Hz 4:4:4 (normal mode) 130m (430ft) – 2K (normal mode) 180m (590ft) – 1080p @60Hz @24bpp (ultra-mode) when using BC-UNIKAT cables
3D PASS THROUGH:	Supported
POWER CONSUMPTION:	Input card: 17W Output card: 13W
OPERATING TEMPERATURE:	0° to +40°C (32° to 104°F)
STORAGE TEMPERATURE:	–40° to +70°C (–40° to 158°F)
HUMIDITY:	10% to 90%, RHL non-condensing
DIMENSIONS:	19cm x 13cm x 2cm (7.5" x 5.1" x 0.8") W, D, H
PRODUCT WEIGHT:	0.26 kg (0.57 lbs) approx.
SHIPPING WEIGHT:	0.28 kg (0.62 lbs) approx.
STANDARD COMPLIANCE:	HDBaseT, HDTV compatible
SAFETY REGULATORY COMPLIANCE:	CE
ENVIRONMENTAL REGULATORY COMPLIANCE:	Complies with appropriate requirements of RoHs and WEEE
INCLUDED ACCESSORIES:	Screwdriver

Defining the HDBT-IN2-F16 / HDBT-OUT2-F16

The **HDBT-IN2-F16** is a 2-Input HDMI over HDBaseT Card (F-16):



The **HDBT-OUT2-F16** is a 2-Output HDMI over HDBaseT Card (F-16):



The **HDBT-IN2-F16** and **HDBT-OUT2-F16** cards include a terminal block for connecting via RS-232 or an IR emitter, such as the **C-A35M/IRE**, or an IR receiver, such as the **C-A35M/IRRN**. For information on the IR wiring scheme, see [IR Wiring Scheme for HDBT Cards](#) on page [58](#). For information on connecting via RS-232, see [Connecting to the VS-1616DN-EM via RS-232](#) on page [13](#).

HDBT-IN2-F16 / HDBT-OUT2-F16 Configuration

The **HDBT-IN2-F16** configuration table appears as follows:

HDBT-IN2-F16 Input Card		
Parameter	Description	Default
HDCP	Turn HDCP on and off. *0=EN, 1=DIS.	0
XTRA	Enables range extender. Off for distances of up to 130m at 1080p @60Hz @36bpp; On for distances of up to 180m at 1080p @60Hz @24bpp. *0:ON, 1:OFF. Note: Distances are valid when using Kramer BC-UNIKAT cables.	1

The **HDBT-OUT2-F16** configuration table appears as follows:

HDBT-OUT2-F16 Output Card		
Parameter	Description	Default
HDMI	Sets the output signal format (Display, HDMI, DVI). Display—the output is set automatically based on the EDID of the connected display. HDMI—Force the output to be HDMI. DVI—Force the output to be DVI. Note: When selecting the DVI option, verify that the input signal originates as RGB or that you convert it to RGB in the input card's Color Space menu – if the EDID dictates RGB color space, copy an EDID that allows RGB only and not YcBcR. When selecting the DVI option and fast switching is enabled, you must ensure that the source is DVI compatible.	Display
Deep Color	Sets maximum color bit depth (Auto, 8 bit). Auto—Set the color depth automatically. 8 bit—Limit the color depth to 8 bits.	Auto
Switch Speed	When switching between different sources the switching time can be reduced by setting the fast switch level (Ex-fast Switch, Fast Switch or Normal Switch).	Normal Switch
XTRA	Enables range extender. Off for distances of up to 130m at 1080p @60Hz @36bpp; On for distances of up to 180m at 1080p @60Hz @24bpp. *0:ON, 1:OFF. Note: Distances are valid when using Kramer BC-UNIKAT cables.	1

HDBT-IN2-F16 / HDBT-OUT2-F16 Technical Specifications



HDBT cards must be used with twisted pair cables with RJ-45 connections, such as Kramer **BC-UNIKAT** shielded twisted pair (U/FTP) cables.

The following table defines the technical specifications.

PORTS:	2 HDBaseT TP on RJ45 connectors 2 RS-232 Serial ports and 2 IR ports on a 10-pin terminal block 1 Ethernet port on an RJ-45 connector
BANDWIDTH PER CHANNEL:	Video: 2.25Gbps Serial Data: 115200
TOTAL BANDWIDTH:	Video: 6.75Gbps Serial Data: 115200
MAXIMUM RANGE:	130m (430ft) normal mode 180m (590ft) ultra-mode (1080p @60Hz @24bpp) when using BC-UNIKAT cables
3D PASS THROUGH:	Supported
POWER CONSUMPTION:	Input card: 15.5W Output card: 10.5W
OPERATING TEMPERATURE:	0° to +40°C (32° to 104°F)
STORAGE TEMPERATURE:	-40° to +70°C (-40° to 158°F)
HUMIDITY:	10% to 90%, RHL non-condensing
DIMENSIONS:	19cm x 13cm x 2cm (7.5" x 5.1" x 0.8") W, D, H
PRODUCT WEIGHT:	0.16 kg (0.35 lbs) approx.
SHIPPING WEIGHT:	0.3 kg (0.66 lbs) approx.
STANDARD COMPLIANCE:	HDBaseT
SAFETY REGULATORY COMPLIANCE:	CE
ENVIRONMENTAL REGULATORY COMPLIANCE:	Complies with appropriate requirements of RoHs and WEEE

IR Wiring Scheme for HDBT Cards

HDBT cards that support IR include either a 3.5mm jack or a terminal block for connecting an IR emitter, such as the **C-A35M/IRE**, or an IR receiver, such as the **C-A35M/IRRN**.

To connect an IR emitter / receiver:

- Using the supplied terminal block connector, connect an IR emitter / receiver according to the wiring scheme in [Figure 15](#):

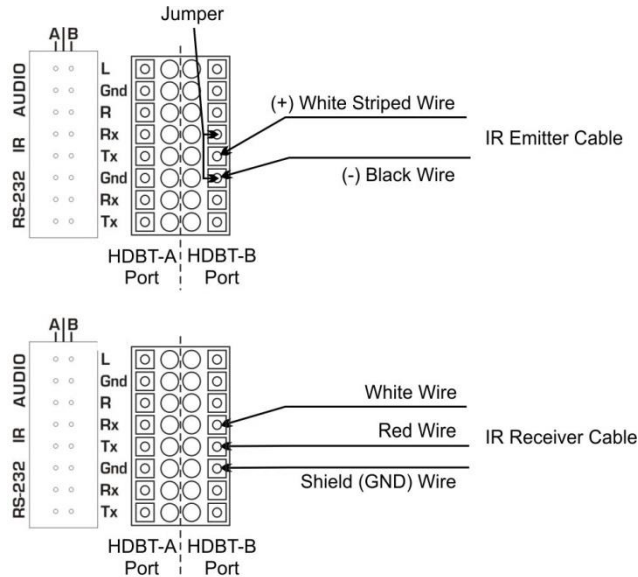

Figure 15: Connecting IR Emitter / Receiver to the HDBT-B Port



The terminal block size and supplied connector differs according to the type of HDBT card. However, the wiring scheme for connecting the IR emitter / receiver is the same for all HDBT cards.

Defining the HH-IN2-F16 / HH-OUT2-F16

The **HH-IN2-F16** is a 2-Input HDMI Card (F-16):



The **HH-OUT2-F16** is a 2-Output HDMI Card (F-16):



HH-IN2-F16 / HH-OUT2-F16 Configuration

The **HH-IN2-F16** configuration table appears as follows:

HH-IN2-F16 Input Card		
Parameter	Description	Default
HDCP	Turn HDCP on and off. *0=EN, 1=DIS.	0
Color Space	Selects the color space of the internal video bus (input is converted to this color space for internal processing only): RGB, Auto.	Auto
Reset Input	Re-power—Power cycles the port. Factory—Performs a factory reset to default values of the port.	Re-power

The **HH-OUT2-F16** configuration table appears as follows:

HH-OUT2-F16 Output Card		
Parameter	Description	Default
Reset Output	Re-power—Power cycles the port. Factory—Performs a factory reset to default values of the port.	Re-power
HDMI	Sets the output signal format (Display, HDMI, DVI). Display—the output is set automatically based on the EDID of the connected display. HDMI—Force the output to be HDMI. DVI—Force the output to be DVI. Note: When selecting the DVI option, verify that the input signal originates as RGB or that you convert it to RGB in the input card's Color Space menu – if the EDID dictates RGB color space, copy an EDID that allows RGB only and not YcBcR. When selecting the DVI option and fast switching is enabled, you must ensure that the source is DVI compatible.	Display
Deep Color	Sets maximum color bit depth (Auto, 8 bit). Auto—Set the color depth automatically. 8 bit—Limit the color depth to 8 bits.	Auto
Switch Speed	When switching between different sources the switching time can be reduced by setting the fast switch level (Ex-fast Switch, Fast Switch or Normal Switch).	Normal Switch

HH-IN2-F16 / HH-OUT2-F16 Technical Specifications

The following table defines the technical specifications.

PORTS:	2 HDMI
BANDWIDTH PER CHANNEL:	2.25Gbps
TOTAL BANDWIDTH:	6.75Gbps
MAXIMUM RANGE:	15m (49ft)
3D PASS THROUGH:	Supported
POWER CONSUMPTION:	Input / Output card: 5W
OPERATING TEMPERATURE:	0° to +40°C (32° to 104°F)
STORAGE TEMPERATURE:	−40° to +70°C (−40° to 158°F)
HUMIDITY:	10% to 90%, RHL non-condensing
DIMENSIONS:	19cm x 13cm x 2cm (7.5" x 5.1" x 0.8") W, D, H
PRODUCT WEIGHT:	0.23 kg (0.51 lbs) approx.
SHIPPING WEIGHT:	0.37 kg (0.82 lbs) approx.
STANDARD COMPLIANCE:	HDCP 1.4
SAFETY REGULATORY COMPLIANCE:	CE
ENVIRONMENTAL REGULATORY COMPLIANCE:	Complies with appropriate requirements of RoHs and WEEE

Defining the HS-OUT2-F16

The **HS-OUT2-F16** is a 2-Output HDMI Scaler-Switcher Card (F-16):



HS-OUT2-F16 Configuration

The **HS-OUT2-F16** configuration table appears as follows:

HS-OUT2-F16 Output Card		
Parameter	Description	Default
HDMI	Sets the output signal format (Display, HDMI, DVI). Display—The output is set automatically based on the EDID of the connected display. HDMI— Force the output to be HDMI. DVI— Force the output to be DVI. Note: When selecting the DVI option, verify that the input signal originates as RGB or that you convert it to RGB in the input card's Color Space menu – if the EDID dictates RGB color space, copy an EDID that allows RGB only and not YcBcR. When selecting the DVI option and fast switching is enabled, you must ensure that the source is DVI compatible.	Display
Deep Color	Sets maximum color bit depth (Auto, 8 bit). Auto—Set the color depth automatically. 8 bit—Limit the color depth to 8 bits.	Auto

HS-OUT2-F16 Output Card		
Parameter	Description	Default
Reset Output	Re-power—Power cycle the port. Factory default—Perform a factory reset to default values of the port.	Re-power
Video-Freeze	Freezes/unfreezes the output video. Off On	Off
Picture Aspect Ratio	Sets the picture aspect ratio. Full Crop Best-Fit	Best-Fit
Out Resolution	Sets the output video resolution. 640x480x60 720x480px60 720x576px50 800x600x60 1024x768x60 1280x720px50 1280x720px60 1280x1024x60 1600x1200x60 1920x1200x60 1920x1080px50 1920x1080px60 Native Note: To ensure a stable output signal using either WUXGA (1920X1200) or UXGA (1600X1200), set the output to 8 bit color depth in the Deep Color menu. Note: For best switching performance ensure that both inputs on the card have the same frame rate.	1920x1080px60
Switch Speed	When switching between different sources the switching time can be reduced by setting the fast switch level (Ex-fast Switch, Fast Switch or Normal Switch).	Ex-fast
FPGA VER	The FPGA version.	
FW VER	The firmware version.	
SPEC VER:0107	For internal use only.	
AUTO SYNC OFF	Determines the timeout period before turning off the output video signal after no input signal is detected. (A black output video signal is sent during this predetermined timeout period.) 0—(Default) Do not turn off the output video signal (keep the output signal alive indefinitely). 1—Turn off the output signal 5 minutes after detecting a loss of the input video signal. 2—Turn off the output signal 10 seconds after detecting a loss of the input video signal.	0

HS-OUT2-F16 Technical Specifications

The following table defines the technical specifications.

PORTS:	2 HDMI
BANDWIDTH PER CHANNEL:	2.25Gbps per graphic channel
MAX DATA RATE:	6.75Gbps (2.25Gbps per graphic channel)
MAX. SCALED OUTPUT RESOLUTION:	1080p, UXGA
MAX. INPUT RESOLUTION:	1080p, UXGA
MAXIMUM RANGE:	15m (49ft) – 1080p 12 bit (deep color)
SWITCHING TIME BETWEEN INPUTS:	Less than 1 second (seamless)
VIDEO LATENCY:	Less than 3 frames
OUTPUT RESOLUTIONS:	Native, 640x480@60Hz, 720x480p@60Hz, 720x576p@50Hz, 800x600@60Hz, 1024x768@60Hz, 1280x720p@50Hz, 1280x720p@60Hz, 1280x1024@60Hz, 1600x1200@60Hz, 1920x1200@60Hz, 1920x1080p@50Hz, 1920x1080p@60Hz
STANDARDS COMPLIANCE:	HDCP 1.4, HDTV compatible
3D PASS THROUGH:	Not supported
POWER CONSUMPTION:	22W
OPERATING TEMPERATURE:	0° to +40°C (32° to 104°F)
STORAGE TEMPERATURE:	–40° to +70°C (–40° to 158°F)
HUMIDITY:	10% to 90%, RHL non-condensing
DIMENSIONS:	19cm x 13cm x 2cm (7.5" x 5.1" x 0.8") W, D, H
PRODUCT WEIGHT:	0.15 kg (0.33 lbs) approx.
SHIPPING WEIGHT:	0.3 kg (0.66 lbs) approx.
STANDARD COMPLIANCE:	HDCP 1.4, HDTV compatible
SAFETY REGULATORY COMPLIANCE:	CE
ENVIRONMENTAL REGULATORY COMPLIANCE:	Complies with appropriate requirements of RoHs and WEEE

Defining the HAD-IN2-F16 / HAD-OUT2-F16

The **HAD-IN2-F16** is a 2-Input HDMI with Digital Audio Card (F-16).

The **HAD-IN2-F16** inputs two HDMI signals to the chassis with optional embedding of digital S/PDIF audio to each HDMI port on the card:



The **HAD-OUT2-F16** is a 2-Output HDMI with Digital Audio Card (F-16).

The **HAD-OUT2-F16** outputs two HDMI signals from the chassis with de-embedding of digital S/PDIF audio from each HDMI port on the card:



Each audio jack enables audio insertion/extraction only to/from its corresponding HDMI port.

HAD-IN2-F16 / HAD-OUT2-F16 Configuration

The **HAD-IN2-F16** configuration table appears as follows:

HAD-IN2-F16 Input Card		
Parameter	Description	Default
Reset Input	Re-power—Power cycles the port. Factory—Performs a factory reset to default values of the port.	Re-power
HDCP	Turn HDCP on and off. *0=EN, 1=DIS.	0
Color Space	Selects the color space of the internal video bus (input is converted to this color space for internal processing only): RGB, Auto.	Auto
Audio Select	Selects the audio source: Auto—Audio signal selection is controlled by the presence or absence of a plug in the RCA port. When present, AUD-Digital is selected, when absent, AUD-Embedded is selected. AUD-Embedded—HDMI audio is selected. AUD-Digital—S/PDIF audio is selected.	Auto

The **HAD-OUT2-F16** configuration table appears as follows:

HAD-OUT2-F16 Output Card		
Parameter	Description	Default
Reset Output	Re-power: power cycle the port. Factory default: perform a factory reset of the port to default values.	Re-power

HAD-OUT2-F16 Output Card		
Parameter	Description	Default
HDMI	<p>Sets the output signal format (Display, HDMI, DVI).</p> <p>Display—the output is set automatically based on the EDID of the connected display.</p> <p>HDMI—Force the output to be HDMI.</p> <p>DVI—Force the output to be DVI.</p> <p>Note: When selecting the DVI option, verify that the input signal originates as RGB or that you convert it to RGB in the input card's Color Space menu – if the EDID dictates RGB color space, copy an EDID that allows RGB only and not YcBcR. When selecting the DVI option and fast switching is enabled, you must ensure that the source is DVI compatible.</p>	Display
Deep Color	<p>Sets maximum color bit depth (Auto, 8 bit).</p> <p>Auto—Set the color depth automatically.</p> <p>8 bit—Limit the color depth to 8 bits.</p>	Auto
Switch Speed	<p>When switching between different sources the switching time can be reduced by setting the fast switch level (Ex-fast Switch, Fast Switch or Normal Switch).</p>	Normal Switch

HAD-IN2-F16 / HAD-OUT2-F16 Technical Specifications

The following table defines the technical specifications.

PORTS:	2 HDMI 2 Digital audio on RCA connectors
BANDWIDTH PER CHANNEL:	2.25Gbps
TOTAL BANDWIDTH:	6.75Gbps
MAXIMUM RANGE:	15m (49ft)
3D PASS THROUGH:	Supported
POWER CONSUMPTION:	Input / Output card: 5.5W
OPERATING TEMPERATURE:	0° to +40°C (32° to 104°F)
STORAGE TEMPERATURE:	−40° to +70°C (−40° to 158°F)
HUMIDITY:	10% to 90%, RHL non-condensing
DIMENSIONS:	19cm x 13cm x 2cm (7.5" x 5.1" x 0.8") W, D, H
PRODUCT WEIGHT:	0.23 kg (0.51 lbs) approx.
SHIPPING WEIGHT:	0.37 kg (0.82 lbs) approx.
STANDARD COMPLIANCE:	HDCP 1.4
SAFETY REGULATORY COMPLIANCE:	CE
ENVIRONMENTAL REGULATORY COMPLIANCE:	Complies with appropriate requirements of RoHs and WEEE

Defining the HAA-IN2-F16 / HAA-OUT2-F16

The **HAA-IN2-F16** is a 2-Input HDMI with Analog Audio Card (F-16). The **HAA-IN2-F16** inputs two HDMI signals to the chassis with optional embedding of unbalanced stereo audio to each HDMI port on the card:



The **HAA-OUT2-F16** is a 2-Output HDMI with Analog Audio Card (F-16). The **HAA-OUT2-F16** outputs two HDMI signals from the chassis with de-embedding of unbalanced stereo audio from each HDMI port on the card:



When a multi-channel audio input signal is routed to a card with stereo analog audio outputs, the analog audio out connectors output the front right and front left audio channels only.

Each audio jack enables audio insertion/extraction only to/from its corresponding HDMI port.

HAA-IN2-F16 / HAA-OUT2-F16 Configuration

The **HAA-IN2-F16** configuration table appears as follows:

HAA-IN2-F16 Input Card		
Parameter	Description	Default
HDCP	Turn HDCP on and off. *0=EN, 1=DIS. Note: Analog audio is still transmitted when HDCP is disabled.	0
Color Space	Selects the color space of the internal video bus (input is converted to this color space for internal processing only): RGB, Auto.	Auto
Audio Select	Auto AUD-Embedded—HDMI audio is selected. AUD-Analog—Analog audio from the 3.5mm mini jack is selected.	Auto
Reset Input	Re-power—Power cycles the port. Factory—Performs a factory reset to default values of the port.	Re-power
Audio Mute	MUTE—Mutes the audio input. Non-MUTE—Unmutes the audio input. Note: Not applicable when digital audio is selected.	Non-MUTE
Volume	Sets the audio output volume (0–70). Note: Not applicable when digital audio is selected.	50
Audio Balance	Sets the audio output channel balance (0–100). Note: Not applicable when digital audio is selected.	50
Audio Bass	Sets the audio output bass level (0–15). Note: Not applicable when digital audio is selected.	7
Audio Treble	Sets the audio output treble level (0–15). Note: Not applicable when digital audio is selected.	7

The **HAA-OUT2-F16** configuration table appears as follows:

HAA-OUT2-F16 Output Card		
Parameter	Description	Default
Reset Output	Re-power—Power cycles the port. Factory—Performs a factory reset to default values of the port.	Re-power
HDMI	Sets the output signal format (Display, HDMI, DVI). Display—the output is set automatically based on the EDID of the connected display. HDMI—Force the output to be HDMI. DVI—Force the output to be DVI. Note: When selecting the DVI option, verify that the input signal originates as RGB or that you convert it to RGB in the input card's Color Space menu – if the EDID dictates RGB color space, copy an EDID that allows RGB only and not YcBcR. When selecting the DVI option and fast switching is enabled, you must ensure that the source is DVI compatible.	Display
Deep Color	Sets maximum color bit depth (Auto, 8 bit). Auto—Set the color depth automatically. 8 bit—Limit the color depth to 8 bits.	Auto
Switch Speed	When switching between different sources the switching time can be reduced by setting the fast switch level (Ex-fast Switch, Fast Switch or Normal Switch).	Normal Switch
Audio Mute	MUTE—Mutes the audio input. Non-MUTE—Unmutes the audio input. Note: When set to Mute, any change to the audio parameters automatically sets this to unmute. Note: Not applicable when digital audio is selected.	Non-MUTE
Volume	Sets the audio output volume (0–70). Note: Not applicable when digital audio is selected.	50
Audio Balance	Sets the audio output channel balance (0–100). Note: Not applicable when digital audio is selected.	50
Audio Bass	Sets the audio output bass level (0–15). Note: Not applicable when digital audio is selected.	7
Audio Treble	Sets the audio output treble level (0–15). Note: Not applicable when digital audio is selected.	7
Audio Mono	OFF—Analog output is stereo. MIX—Analog output is mono. Note: Not applicable when digital audio is selected.	OFF

HAA-IN2-F16 / HAA-OUT2-F16 Technical Specifications

The following table defines the technical specifications.

PORTS:	2 HDMI 2 Analog audio on 3.5mm mini jacks
BANDWIDTH PER CHANNEL:	2.25Gbps
TOTAL BANDWIDTH:	6.75Gbps
MAXIMUM RANGE:	15m (49ft)
3D PASS THROUGH:	Supported
POWER CONSUMPTION:	Input card: 6.5W Output card: 7W
OPERATING TEMPERATURE:	0° to +40°C (32° to 104°F)
STORAGE TEMPERATURE:	-40° to +70°C (-40° to 158°F)
HUMIDITY:	10% to 90%, RHL non-condensing
DIMENSIONS:	19cm x 13cm x 2cm (7.5" x 5.1" x 0.8") W, D, H
PRODUCT WEIGHT:	0.23 kg (0.51 lbs) approx.
SHIPPING WEIGHT:	0.37 kg (0.82 lbs) approx.
STANDARD COMPLIANCE:	HDCP 1.4
SAFETY REGULATORY COMPLIANCE:	CE
ENVIRONMENTAL REGULATORY COMPLIANCE:	Complies with appropriate requirements of RoHs and WEEE

Defining the HDCP-IN2-F16 / HDCP-OUT2-F16

The **HDCP-IN2-F16** is a 2-Input DVI (HDCP) Card (F-16):



The **HDCP-OUT2-F16** is a 2-Output DVI (HDCP) Card (F-16):



HDCP-IN2-F16 / HDCP-OUT2-F16 Configuration

The **HDCP-IN2-F16** configuration table appears as follows:

HDCP-IN2-F16 Input Card		
Parameter	Description	Default
HDCP	Turn HDCP on and off. *0=EN, 1=DIS.	0

The **HDCP-OUT2-F16** configuration table appears as follows:

HDCP-OUT2-F16 Output Card		
Parameter	Description	Default
HDMI	Sets the output signal format (Display, HDMI, DVI). Display—the output is set automatically based on the EDID of the connected display. HDMI—Force the output to be HDMI. DVI—Force the output to be DVI. Note: When selecting the DVI option, verify that the input signal originates as RGB or that you convert it to RGB in the input card's Color Space menu – if the EDID dictates RGB color space, copy an EDID that allows RGB only and not YcBcR. When selecting the DVI option and fast switching is enabled, you must ensure that the source is DVI compatible.	Display
Deep Color	Sets maximum color bit depth (Auto, 8 bit). Auto—Set the color depth automatically. 8 bit—Limit the color depth to 8 bits.	Auto
Switch Speed	When switching between different sources the switching time can be reduced by setting the fast switch level (Ex-fast Switch, Fast Switch or Normal Switch).	Normal Switch

HDCP-IN2-F16 / HDCP-OUT2-F16 Technical Specifications

The following table defines the technical specifications.

PORTS:	2 DVI-D on a DVI Molex 24-pin (F) connector
BANDWIDTH PER CHANNEL:	2.25Gbps
TOTAL BANDWIDTH:	6.75Gbps
MAXIMUM RANGE:	15m (49ft)
3D PASS THROUGH:	Supported
POWER CONSUMPTION:	Input / Output card: 5W
OPERATING TEMPERATURE:	0° to +40°C (32° to 104°F)
STORAGE TEMPERATURE:	–40° to +70°C (–40° to 158°F)
HUMIDITY:	10% to 90%, RHL non-condensing
DIMENSIONS:	19cm x 13cm x 2cm (7.5" x 5.1" x 0.8") W, D, H
PRODUCT WEIGHT:	0.23 kg (0.51 lbs) approx.
SHIPPING WEIGHT:	0.37 kg (0.82 lbs) approx.
STANDARD COMPLIANCE:	HDCP, HDMI
SAFETY REGULATORY COMPLIANCE:	CE, FCC
ENVIRONMENTAL REGULATORY COMPLIANCE:	Complies with appropriate requirements of RoHs and WEEE

Defining the DGKat-IN2-F16 / DGKat-OUT2-F16

The **DGKat-IN2-F16** is a 2-Input HDMI & RS-232 over DGKat Card (F-16):

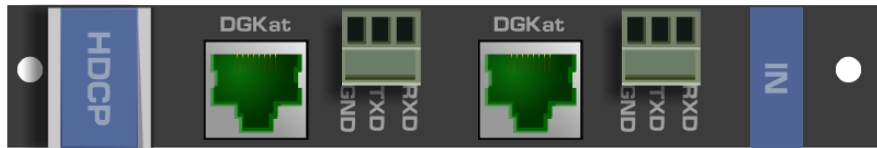

The **DGKat-OUT2-F16** is a 2-Output HDMI & RS-232 Input over DGKat Card (F-16):

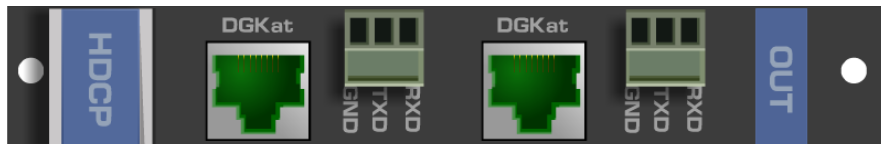

DGKat-IN2-F16 / DGKat-OUT2-F16 Configuration

The **DGKat-IN2-F16** configuration table appears as follows:

DGKat-IN2-F16 Input Card		
Parameter	Description	Default
HDCP	Turn HDCP on and off. *0=EN, 1=DIS.	0

The **DGKat-OUT2-F16** configuration table appears as follows:

DGKat-OUT2-F16 Output Card		
Parameter	Description	Default
HDMI	Sets the output signal format (Display, HDMI, DVI). Display—the output is set automatically based on the EDID of the connected display. HDMI—Force the output to be HDMI. DVI—Force the output to be DVI. Note: When selecting the DVI option, verify that the input signal originates as RGB or that you convert it to RGB in the input card's Color Space menu – if the EDID dictates RGB color space, copy an EDID that allows RGB only and not YcBcR. When selecting the DVI option and fast switching is enabled, you must ensure that the source is DVI compatible.	Display
Deep Color	Sets maximum color bit depth (Auto, 8 bit). Auto—Set the color depth automatically. 8 bit—Limit the color depth to 8 bits. Note: Deep color on DGKat is not supported at higher resolutions (1080p @50/60Hz or WUXGA). When setting deep color to on, ensure that the resolution does not exceed the DGKat maximum data rate of 4.95Gbps (1.65Gbps per graphic channel).	Auto
Switch Speed	When switching between different sources the switching time can be reduced by setting the fast switch level (Ex-fast Switch, Fast Switch or Normal Switch).	Normal Switch

DGKat-IN2-F16 / DGKat-OUT2-F16 Technical Specifications



DGKat cards must be used with shielded twisted pair cables with RJ-45 connections, such as the Kramer **BC-UNIKAT**. For more information, see the *DGKat Installation Guide*. DGKat cards support Deep Color only at resolutions of 720p and lower.

The following table defines the technical specifications.

PORTS:	2 TP DGKat ports on RJ-45 2 Serial ports on 3-pin terminal blocks
BANDWIDTH PER CHANNEL:	Video: 1.65Gbps Serial Data: 19200
TOTAL BANDWIDTH:	Video: 4.95Gbps Serial Data: 19200
MAXIMUM RANGE:	90m (300ft) – 1080p @60Hz when using BC-UINIKAT cable
3D PASS THROUGH:	Supported
POWER CONSUMPTION:	Input card: 12W Output card: 10W
OPERATING TEMPERATURE:	0° to +40°C (32° to 104°F)
STORAGE TEMPERATURE:	–40° to +70°C (–40° to 158°F)
HUMIDITY:	10% to 90%, RHL non-condensing
DIMENSIONS:	19cm x 13cm x 2cm (7.5" x 5.1" x 0.8") W, D, H
PRODUCT WEIGHT:	0.16 kg (0.51 lbs) approx.
SHIPPING WEIGHT:	0.37 kg (0.82 lbs) approx.
STANDARD COMPLIANCE:	HDCP 1.4
SAFETY REGULATORY COMPLIANCE:	CE, FCC
ENVIRONMENTAL REGULATORY COMPLIANCE:	Complies with appropriate requirements of RoHs and WEEE
INCLUDED ACCESSORIES:	Screwdriver

About the Power Connect™ Feature

The Power Connect™ feature here means that the **VS-1616DN-EM** can supply power to the TP transmitters and receivers (for example, the **TP-573** and **TP-574**).

Serial Data Flow on DGKat Plus RS-232 Cards

Serial data present on the RS-232 port of a DGKat input /output card is not transmitted via the switcher. This data is transmitted over the TP cable of the same input / output card (see [Figure 16](#)).

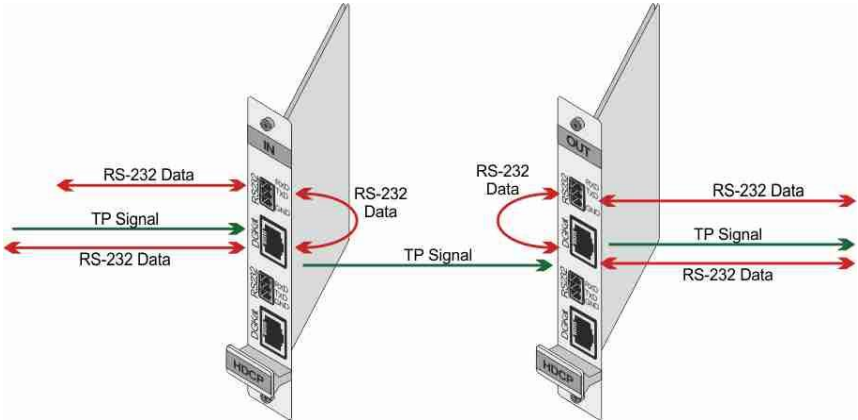

Figure 16: DGKat Card Serial Data Transmission

Defining the F670-IN2-F16 / F670-OUT2-F16

F670 cards are fully compatible with the Kramer **670T/670R** and **671T/671R** HDMI/DVI transmitters and receivers for non-HDCP content.

The **F670-IN2-F16** is a 2-Input HDMI over OM3 Fiber Card (F-16):



The **F670-OUT2-F16** is a 2-Output HDMI over OM3 Fiber Card (F-16):

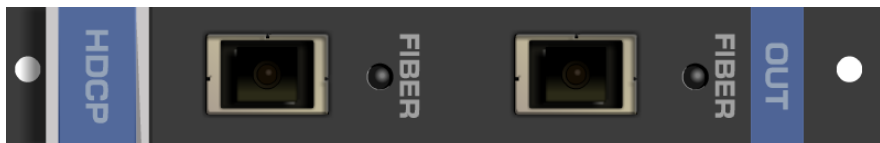

F670-IN2-F16 / F670-OUT2-F16 Configuration

The **F670-IN2-F16** configuration table appears as follows:

F670-IN2-F16 Input Card		
Parameter	Description	Default
Reset Input	Re-power—Power cycles the port. Factory—Performs a factory reset to default values of the port.	Re-power
HDCP	Turn HDCP on and off. *0=EN, 1=DIS.	0

The **F670-OUT2-F16** configuration table appears as follows:

F670-OUT2-F16 Output Card		
Parameter	Description	Default
Reset Output	Re-power—Power cycles the port. Factory—Performs a factory reset to default values of the port.	Re-power
HDMI	Sets the output signal format (Display, HDMI, DVI). Display—the output is set automatically based on the EDID of the connected display. HDMI—Force the output to be HDMI. DVI—Force the output to be DVI. Note: When selecting the DVI option, verify that the input signal originates as RGB or that you convert it to RGB in the input card's Color Space menu – if the EDID dictates RGB color space, copy an EDID that allows RGB only and not YcBcR. When selecting the DVI option and fast switching is enabled, you must ensure that the source is DVI compatible.	Display
Deep Color	Sets maximum color bit depth (Auto, 8 bit). Auto—Set the color depth automatically. 8 bit—Limit the color depth to 8 bits.	Auto
Switch Speed	When switching between different sources the switching time can be reduced by setting the fast switch level (Ex-fast Switch, Fast Switch or Normal Switch).	Normal Switch

F670-IN2-F16 / F670-OUT2-F16 Technical Specifications



F670 cards must be used with multi-mode glass fiber cables with SC connections, such as the Kramer **C-SC/SC/OM3**.

The following table defines the technical specifications.

PORTS:	2 SC
BANDWIDTH PER CHANNEL:	2.25Gbps
TOTAL BANDWIDTH:	6.75Gbps
MAXIMUM RANGE:	1700m (5570ft) – 1080p/60Hz
3D PASS THROUGH:	Supported
POWER CONSUMPTION:	Input card: 7W Output card: 7.5W
OPERATING TEMPERATURE:	0° to +40°C (32° to 104°F)
STORAGE TEMPERATURE:	–40° to +70°C (–40° to 158°F)
HUMIDITY:	10% to 90%, RHL non-condensing
DIMENSIONS:	19cm x 13cm x 2cm (7.5" x 5.1" x 0.8") W, D, H
PRODUCT WEIGHT:	0.14 kg (0.31 lbs) approx.
SHIPPING WEIGHT:	0.28 kg (0.62 lbs) approx.
STANDARD COMPLIANCE:	HDCP 1.4
SAFETY REGULATORY COMPLIANCE:	CE, FCC
ENVIRONMENTAL REGULATORY COMPLIANCE:	Complies with appropriate requirements of RoHs and WEEE

Defining the F610-IN2-F16 / F610-OUT2-F16

The **F610-IN2-F16** is a 2-Input DVI over 4LC Fiber Card (F-16):

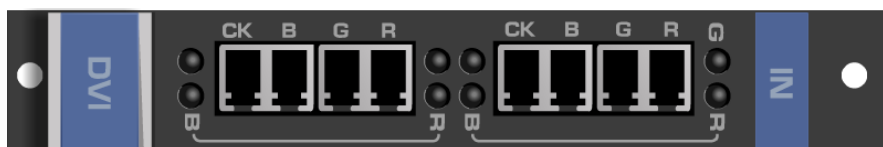

The **F610-OUT2-F16** is a 2-Output DVI over 4LC Fiber Card (F-16):

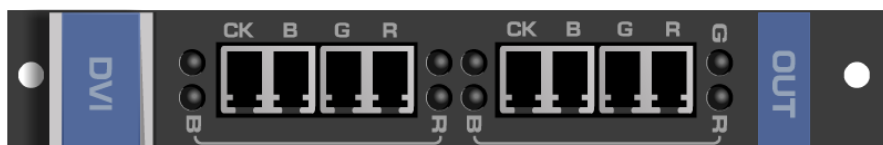

F610-IN2-F16 / F610-OUT2-F16 Configuration

The **F610-OUT2-F16** configuration table appears as follows:

F610-OUT2-F16 Output Card		
Parameter	Description	Default
Switch Speed	When switching between different sources the switching time can be reduced by setting the fast switch level (Ex-fast Switch, Fast Switch or Normal Switch).	Normal Switch

F610-IN2-F16 / F610-OUT2-F16 Technical Specifications



F610 cards must be used with multi-mode glass fiber cables with LC connections, such as the Kramer **C-4LC/4LC**.

The following table defines the technical specifications.

PORTS:	2 4 LC ports
BANDWIDTH PER CHANNEL:	1.65Gbps
TOTAL BANDWIDTH:	6.75Gbps
MAXIMUM RANGE:	400m (1310ft) using Multi Mode OM2 fiber
3D PASS THROUGH:	Not supported
POWER CONSUMPTION:	Input card: 2.8W Output card: 3.8W
OPERATING TEMPERATURE:	0° to +40°C (32° to 104°F)
STORAGE TEMPERATURE:	-40° to +70°C (-40° to 158°F)
HUMIDITY:	10% to 90%, RHL non-condensing
DIMENSIONS:	19cm x 13cm x 2cm (7.5" x 5.1" x 0.8") W, D, H
PRODUCT WEIGHT:	0.23 kg (0.51 lbs) approx.
SHIPPING WEIGHT:	0.37 kg (0.82 lbs) approx.
STANDARD COMPLIANCE:	DVI 1.0
SAFETY REGULATORY COMPLIANCE:	CE, FCC
ENVIRONMENTAL REGULATORY COMPLIANCE:	Complies with appropriate requirements of RoHs and WEEE

Defining the DVI-IN2-F16 / DVI-OUT2-F16

The **DVI-IN2-F16** is a 2-Input DVI Card (F-16):



The **DVI-OUT2-F16** is a 2-Output DVI Card (F-16):



DVI-IN2-F16 / DVI-OUT2-F16 Configuration

The **DVI-OUT2-F16** configuration table appears as follows:

DVI-OUT2-F16 Output Card		
Parameter	Description	Default
Switch Speed	When switching between different sources the switching time can be reduced by setting the fast switch level (Ex-fast Switch, Fast Switch or Normal Switch).	Normal Switch

DVI-IN2-F16 / DVI-OUT2-F16 Technical Specifications

The following table defines the technical specifications.

PORTS:	2 DVI-D on DVI Molex 24-pin (F) connectors
BANDWIDTH PER CHANNEL:	1.65Gbps
TOTAL BANDWIDTH:	4.95Gbps
MAXIMUM RANGE:	15m (49ft)
3D PASS THROUGH:	Not supported
POWER CONSUMPTION:	Input card: 1.6W Output card: 2.2W
OPERATING TEMPERATURE:	0° to +40°C (32° to 104°F)
STORAGE TEMPERATURE:	-40° to +70°C (-40° to 158°F)
HUMIDITY:	10% to 90%, RHL non-condensing
DIMENSIONS:	19cm x 13cm x 2cm (7.5" x 5.1" x 0.8") W, D, H
PRODUCT WEIGHT:	0.23 kg (0.51 lbs) approx.
SHIPPING WEIGHT:	0.37 kg (0.82 lbs) approx.
STANDARD COMPLIANCE:	DVI 1.0
SAFETY REGULATORY COMPLIANCE:	CE, FCC
ENVIRONMENTAL REGULATORY COMPLIANCE:	Complies with appropriate requirements of RoHs and WEEE

Defining the DL-IN1-F16 / DL-OUT1-F16

The **DL-IN1-F16** is a 1-Input DVI Dual Link Card (F-16):

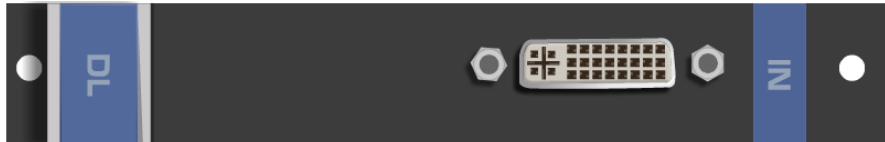

The **DL-OUT1-F16** is a 1-Output DVI Dual Link Card (F-16):



DL-IN1-F16 / DL-OUT1-F16 Configuration

N/A

DL-IN1-F16 / DL-OUT1-F16 Technical Specifications

The following table defines the technical specifications.

PORTS:	1 DVI-D on a DVI Molex 24-pin (F) connector
BANDWIDTH:	3.3Gbps
TOTAL BANDWIDTH:	9.9Gbps
MAXIMUM RANGE:	15m (49ft)
3D PASS THROUGH:	Not supported
POWER CONSUMPTION:	Input card: 1.6W Output card: 2W
OPERATING TEMPERATURE:	0° to +40°C (32° to 104°F)
STORAGE TEMPERATURE:	–40° to +70°C (–40° to 158°F)
HUMIDITY:	10% to 90%, RHL non-condensing
DIMENSIONS:	19cm x 13cm x 2cm (7.5" x 5.1" x 0.8") W, D, H
PRODUCT WEIGHT:	0.23 kg (0.51 lbs) approx.
SHIPPING WEIGHT:	0.37 kg (0.82 lbs) approx.
STANDARD COMPLIANCE:	DVI 1.0
SAFETY REGULATORY COMPLIANCE:	CE, FCC
ENVIRONMENTAL REGULATORY COMPLIANCE:	Complies with appropriate requirements of RoHs and WEEE

Defining the SDIA-IN2-F16

The **SDIA-IN2-F16** is a 2-Input SDI with Analog Audio Card (F-16):



SDIA-IN2-F16 Configuration

The **SDIA-IN2-F16** configuration table appears as follows:

SDIA-IN2-F16 Input Card		
Parameter	Description	Default
Color Space	Selects the color space of the internal video bus (input is converted to this color space for internal processing only): RGB, YUV422, YUV444.	RGB
Reset Input	Re-power—Power cycles the port. Factory default—Performs a factory reset to default values of the port.	Re-power
Volume	Sets the volume of audio port. Range: 0-70. Note: Not applicable when digital audio is selected.	50
Audio Balance	Sets the balance of the audio port. Range: 0-100. Note: Not applicable when digital audio is selected.	50
Audio Bass	Sets the bass of the audio port. Range: 0-15. Note: Not applicable when digital audio is selected.	7
Audio Treble	Sets the treble of the audio port. Range: 0-15. Note: Not applicable when digital audio is selected.	7

SDIA-IN2-F16 Input Card		
Parameter	Description	Default
Audio Mute	Enables muting or enabling the audio on the audio port: MUTE—Mutes the audio input. Non-MUTE—Unmutes the audio input. Note: When set to Mute, any change to the audio parameters automatically sets this to unmute. Note: Not applicable when digital audio is selected.	Non-MUTE
Audio Select	Selects the audio source: Auto—Audio signal selection is controlled by the presence or absence of a plug in the 3.5mm mini jack. When present, AUD-Analog is selected, when absent, AUD-Embedded is selected. AUD-Embedded—In-band SDI audio is selected. AUD-Analog—3.5mm mini jack analog stereo audio is selected.	Auto
SDI_AUDIO_SWITCH	Selects the SDI audio channel. Range: 0-15 (see SDI Audio Switch Configuration on page 78). Only available when Audio Select is set to AUD-Embedded.	0

SDI Audio Switch Configuration

The selected in-band SDI channels to be embedded into the HDMI matrix port audio channel can be configured in the SDI_AUDIO_SWITCH menu. Each input's SDI audio switch can be configured separately. The card stores the current option for each port.

The following table describes the values in the SDI_AUDIO_SWITCH menu:

Value	SDI Audio Number		Description
	Group #	Channel Pair #	
0	1	1	2 channels (Stereo)
1		2	
2	2	1	
3		2	
4	3	1	
5		2	
6	4	1	
7		2	
8	1	1 + 2	4 channels
9	2	1 + 2	
10	1	1 + 2	6 channels (5.1 surround)
	+ 2	+ 1	
11	1	1 + 2	8 channels (7.1 surround)
	+	+	
	2	1 + 2	
12	3	1 + 2	4 channels
13	4	1 + 2	
14	3	1 + 2	6 channels (5.1 surround)
	+	+	
	4	1	
15	3	1 + 2	8 channels (7.1 surround)
	+	+	
	4	1 + 2	

SDIA-IN2-F16 Technical Specifications



The **SDIA-IN2-F16** does not support 3D functionality. The card supports 3Gbps, HD, and SD.

The following table defines the technical specifications.

PORTS:	2 unbalanced analog audio on 3.5mm mini jack connectors 2 SDI, 75Ω on BNC connectors
TOTAL BANDWIDTH:	3Gbps
MAXIMUM RANGE:	300m (980ft) – SD 200m (655ft) – HD 1080p 90m (295ft) – 3G 1080p
3D PASS THROUGH:	Not supported
POWER CONSUMPTION:	6W
OPERATING TEMPERATURE:	0° to +40°C (32° to 104°F)
STORAGE TEMPERATURE:	–40° to +70°C (–40° to 158°F)
HUMIDITY:	10% to 90%, RHL non-condensing
DIMENSIONS:	19cm x 13cm x 2cm (7.5" x 5.1" x 0.8") W, D, H
PRODUCT WEIGHT:	0.23 kg (0.51 lbs) approx.
SHIPPING WEIGHT:	0.37 kg (0.82 lbs) approx.
STANDARD COMPLIANCE:	-
SAFETY REGULATORY COMPLIANCE:	CE
ENVIRONMENTAL REGULATORY COMPLIANCE:	Complies with appropriate requirements of RoHs and WEEE

Defining the VGA-IN2-F16 / VGA-OUT2-F16

The **VGA-IN2-F16** is a 2-Input VGA Card (F-16):

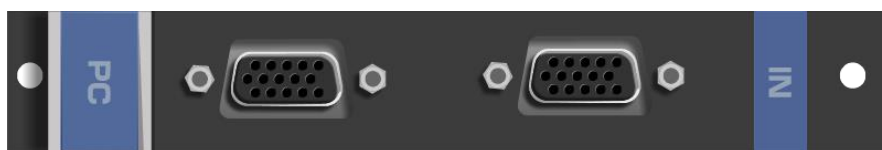

The **VGA-OUT2-F16** is a 2-Output VGA Card (F-16):

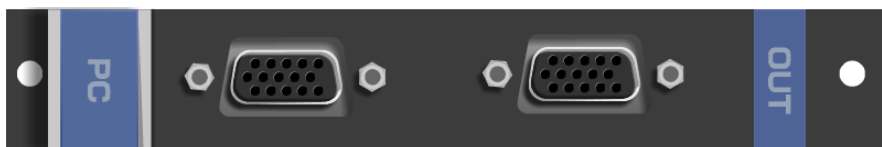

VGA-IN2-F16 / VGA-OUT2-F16 Configuration

The **VGA-IN2-F16** configuration table appears as follows:

VGA-IN2-F16 Input Card		
Parameter	Description	Default
Resolution Detect	Auto, User Defined, Auto Adjust, (see note below table).	Auto
Phase Mode	Auto, User Defined, Auto Adjust, (see note below table).	User Defined
Brightness	(0–63)	32
Contrast	(0–63)	32
Phase adjustment	(0–63) Note: This adjustment is only valid when Phase Mode Is set to User Defined mode.	As detected
Reset Input	Re-power: power cycles the port. Factory: performs a factory reset of the port to default values.	Re-power
Hor-Total Pixels	Set the value for total horizontal pictures. (1–7000)	As detected
Horizontal-Start	Set the value for horizontal start. (1–600)	As detected
Horizontal-Active	Set the value for horizontal active pixels. (1–4000)	As detected
Vertical-Start	Set the value for vertical start. (1–255)	As detected
Vertical-Active	Set the value for vertical active pixels. (1–3000)	As detected
Save Timing Para	(0–31)	0
Recall Timing Para	(0–31)	0
R-offset	(0–63)	32
G-offset	(0–63)	32
B-offset	(0–63)	32
R-gain	(0–63)	32
G-gain	(0–63)	32
B-gain	(0–63)	32



The Auto Adjust feature requires the device to recalculate the parameters based on the currently connected source. The result may be different from the standard parameters for the currently set resolution. The result is saved in non-volatile memory and is recalled when the same source is used again. In order to revert to auto predefined parameters, either reset to factory setting with the relevant source connected or connect a different source.

The **VGA-OUT2-F16** configuration table appears as follows:

VGA-OUT2-F16 Output Card		
Parameter	Description	Default
Switch Speed	When switching between different sources the switching time can be reduced by setting the fast switch level (Ex-fast Switch, Fast Switch or Normal Switch).	Normal Switch

VGA-IN2-F16 / VGA-OUT2-F16 Technical Specifications

The following table defines the technical specifications.

PORTS:	2 VGA on 15-pin HD connectors
BANDWIDTH:	450MHz
MAXIMUM RANGE:	10m (32ft)
POWER CONSUMPTION:	Input card: 5.5W Output card: 4W
OPERATING TEMPERATURE:	0° to +40°C (32° to 104°F)
STORAGE TEMPERATURE:	-40° to +70°C (-40° to 158°F)
HUMIDITY:	10% to 90%, RHL non-condensing
DIMENSIONS:	19cm x 13cm x 2cm (7.5" x 5.1" x 0.8") W, D, H
PRODUCT WEIGHT:	0.23 kg (0.51 lbs) approx.
SHIPPING WEIGHT:	0.37 kg (0.82 lbs) approx.
STANDARD COMPLIANCE:	-
SAFETY REGULATORY COMPLIANCE:	CE
ENVIRONMENTAL REGULATORY COMPLIANCE:	Complies with appropriate requirements of RoHs and WEEE

Defining the VGAA-OUT2-F16 / VGAA-IN2-F16

The **VGAA-IN2-F16** is a 2-Input VGA with Analog Audio Card (F-16):

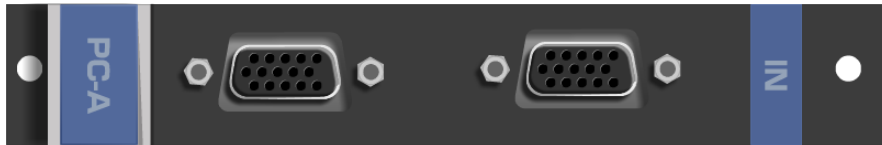

The **VGAA-OUT2-F16** is a 2-Output VGA with Analog Audio Card (F-16):

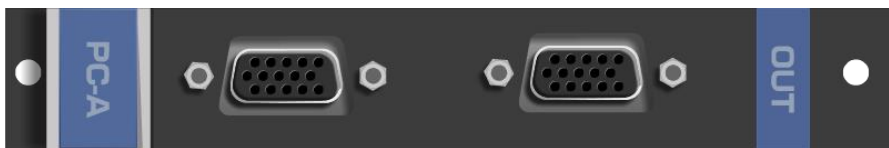



Audio output is accessed by connecting the two supplied Kramer **C-GF/GMAF-30** cables to each VGA port as illustrated in [Figure 17](#).

When a multi-channel audio input signal is routed to a card with stereo analog audio outputs, the analog audio out connectors output the front right and front left audio channels only.

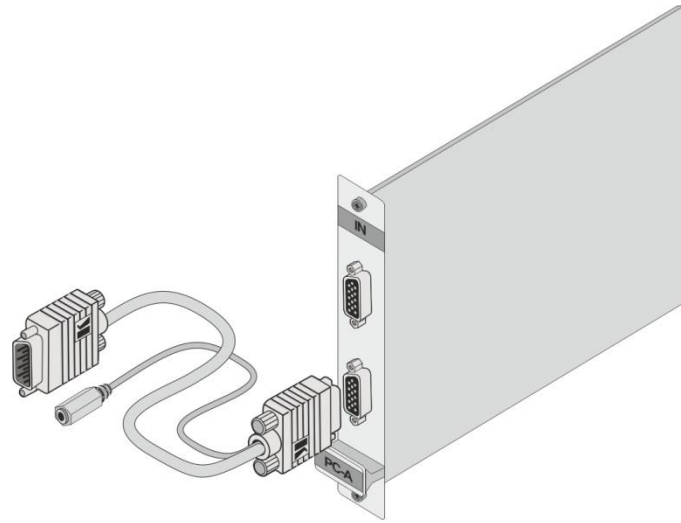

Figure 17: Accessing Audio over VGA

VGAA-OUT2-F16 / VGAA-IN2-F16 Configuration

The **VGAA-IN2-F16** configuration table appears as follows:

VGAA-IN2-F16 Input Card		
Parameter	Description	Default
Resolution Detect	Auto, User Defined, Auto Adjust, (see note below table).	Auto
Phase Mode	Auto, User Defined, Auto Adjust, (see note below table).	Auto
Brightness	(0–63)	32
Contrast	(0–63)	32
Phase adjustment	(0–63) Note: This adjustment is only valid when Phase Mode Is set to User Defined mode.	As detected
Reset Input	Re-power—Power cycles the port. Factory—Performs a factory reset of the port to default values.	Re-power
Hor-Total Pixels	Set the value for total horizontal pictures. (1–7000)	As detected
Horizontal-Start	Set the value for horizontal start. (1–600)	As detected
Horizontal-Active	Set the value for horizontal active pixels. (1–4000)	As detected
Vertical-Start	Set the value for vertical start. (1–255)	As detected
Vertical-Active	Set the value for vertical active pixels. (1–3000)	As detected
Save Timing Para	(0–31)	N/A
Recall Timing Para	(0–31)	N/A
Volume	Sets the audio output volume (0–70).	50
Audio Balance	Sets the audio output channel balance (0–100).	50
Audio Bass	Sets the audio output bass level (0–15).	7
Audio Treble	Sets the audio output treble level (0–15).	7
Audio Mute	MUTE—Mutes the audio input. Non-MUTE—Unmutes the audio input. Note: When set to Mute, any change to the audio parameters automatically sets this to unmute.	Non-MUTE
R-offset	(0–63)	32
G-offset	(0–63)	32
B-offset	(0–63)	32
R-gain	(0–63)	32
G-gain	(0–63)	32
B-gain	(0–63)	32



The Auto Adjust feature requires the device to recalculate the parameters based on the currently connected source. The result may be different from the standard parameters for the currently set resolution. The result is saved in non-volatile memory and is recalled when the same source is used again. In order to revert to auto predefined parameters, either reset to factory setting with the relevant source connected or connect a different source.

The **VGAA-OUT2-F16** configuration table appears as follows:

VGAA-OUT2-F16 Output Card		
Parameter	Description	Default
Reset Output	Re-power: power cycles the port. Factory: performs a factory reset of the port to default values.	Re-power
Switch Speed	When switching between different sources the switching time can be reduced by setting the fast switch level (Ex-fast Switch, Fast Switch or Normal Switch).	Normal Switch
Volume	Sets the audio output volume (0–70).	50
Audio Balance	Sets the audio output channel balance (0–100).	50
Audio Bass	Sets the audio output bass level (0–15).	7
Audio Treble	Sets the audio output treble level (0–15).	7
Audio Mute	MUTE: mutes the audio input. Non-MUTE: unmutes the audio input. Note: When set to Mute, any change to the audio parameters automatically sets this to unmute.	Non-MUTE
OUT_HSYNC_INVERT	Sets the H_SYNC invert. (0, 1)	0
OUT_VSYNC_INVERT	Sets the V_SYNC invert. (0, 1)	0

VGAA-OUT2-F16 / VGAA-IN2-F16 Technical Specifications

The following table defines the technical specifications.

PORTS:	2 VGA on 15-pin HD connectors 2 unbalanced analog audio on 3.5mm mini jack connectors (accessible via C-GF/GMAF-30 cables)
BANDWIDTH:	450MHz
MAXIMUM RANGE:	10m (32ft)
POWER CONSUMPTION:	Input card: 9.5W Output card: 5.5W
OPERATING TEMPERATURE:	0° to +40°C (32° to 104°F)
STORAGE TEMPERATURE:	–40° to +70°C (–40° to 158°F)
HUMIDITY:	10% to 90%, RHL non-condensing
DIMENSIONS:	19cm x 13cm x 2cm (7.5" x 5.1" x 0.8") W, D, H
PRODUCT WEIGHT:	0.13 kg (0.29 lbs) approx.
SHIPPING WEIGHT:	0.52 kg (1.15 lbs) approx.
STANDARD COMPLIANCE:	-
SAFETY REGULATORY COMPLIANCE:	CE
ENVIRONMENTAL REGULATORY COMPLIANCE:	Complies with appropriate requirements of RoHs and WEEE
INCLUDED ACCESSORIES:	2 C-GF/GMAF-30 cables

Defining the AAD-IN2-F16 / AAD-OUT2-F16

The **AAD-IN2-F16** is a 2-Input Analog & Digital Audio Card (F-16):



The **AAD-OUT2-F16** is a 2-Output Analog & Digital Audio Card (F-16):



When a multi-channel audio input signal is routed to a card with digital and analog stereo audio outputs, the digital connectors output multi-channel audio and the analog connectors output the front right and front left audio channels only.

AAD-IN2-F16 / AAD-OUT2-F16 Configuration

The **AAD-IN2-F16** configuration table appears as follows:

AAD-IN2-F16 Input Card		
Parameter	Description	Default
Pattern	RGB Bar, Black.	RGB Bar
Reset Input	Re-power—Power cycles the port. Factory Reset—Performs a factory reset of the port to default values.	Re-power
Audio Select	Selects the audio source: Auto—Audio signal selection is controlled by the presence or absence of a plug in the RCA port. When present, AUD-Digital is selected, when absent, AUD-Analog is selected. AUD-Digital—Digital audio is selected from the RCA ports. AUD-Analog—Analog audio from the 5-pin terminal blocks is selected.	Auto
Audio Mute	MUTE—Mutes the audio input. Non-MUTE—Unmutes the audio input. Note: When set to Mute, any change to the audio parameters automatically sets this to unmute. Note: Not applicable when digital audio is selected.	Non-MUTE
Volume	Sets the audio output volume (0–70). Note: Not applicable when digital audio is selected. Applies to analog inputs and outputs only.	50
Audio Balance	Sets the audio output channel balance (0–100). Note: Not applicable when digital audio is selected.	50
Audio Bass	Sets the audio output bass level (0–15). Note: Not applicable when digital audio is selected.	7
Audio Treble	Sets the audio output treble level (0–15). Note: Not applicable when digital audio is selected.	7

The **AAD-OUT2-F16** configuration table appears as follows:

AAD-OUT2-F16 Output Card		
Parameter	Description	Default
Reset Output	Re-power—Power cycles the port. Factory Reset—Performs a factory reset of the port to default values.	Re-power
Volume	Sets the audio output volume (0–70). Note: Not applicable when digital audio is selected.	50
Audio Balance	Sets the audio output channel balance (0–100). Note: Not applicable when digital audio is selected.	50
Audio Bass	Sets the audio output bass level (0–15). Note: Not applicable when digital audio is selected.	7
Audio Treble	Sets the audio output treble level (0–15). Note: Not applicable when digital audio is selected.	7
Audio Mute	MUTE—Mutes the audio output. Non-MUTE—Unmutes the audio output. Note: When set to Mute, any change to the audio parameters automatically sets this to unmute. Note: Not applicable when digital audio is selected.	Non-MUTE
Audio MONO	OFF—Analog output is stereo. MIX—Analog output is mono.	OFF

AAD-IN2-F16 / AAD-OUT2-F16 Technical Specifications

The following table defines the technical specifications.

PORTS:	2 S/PDIF (digital audio) on RCA connectors 2 balanced audio stereo (analog audio) on 5-pin terminal blocks
BANDWIDTH PER CHANNEL:	-
TOTAL BANDWIDTH:	Analog (-3db): >100kHz Digital: 32kHz - 192kHz sample frequency
POWER CONSUMPTION:	Input / Output card: 5.8W
OPERATING TEMPERATURE:	0° to +40°C (32° to 104°F)
STORAGE TEMPERATURE:	-40° to +70°C (-40° to 158°F)
HUMIDITY:	10% to 90%, RHL non-condensing
DIMENSIONS:	19cm x 13cm x 2cm (7.5" x 5.1" x 0.8") W, D, H
PRODUCT WEIGHT:	0.23 kg (0.51 lbs) approx.
SHIPPING WEIGHT:	0.37 kg (0.82 lbs) approx.
SAFETY REGULATORY COMPLIANCE:	CE
ENVIRONMENTAL REGULATORY COMPLIANCE:	Complies with appropriate requirements of RoHs and WEEE

Defining the UHDS-OUT2-F16

UHDS-OUT2-F16 is a 2-Channel 4K HDMI Scaler-Switcher Output Card:



When a multi-channel audio input signal is routed to a card with digital and analog stereo audio outputs, the digital connectors output multi-channel audio and the analog connectors output the front right and front left audio channels only.

UHDS-OUT2-F16 Configuration

The **UHDS-OUT2-F16** configuration table appears as follows:

AAD-IN2-F16 Input Card		
Parameter	Description	Default
Brightness	(0–63)	32
Contrast	(0–63)	32
Reset Output	Re-power—Power cycles the port. Factory Reset—Performs a factory reset of the port to default values.	Re-power
Out Resolution	Sets the output video resolution. 1920x1080px60 1920x1080px50 1280x720px60 1280x720px50 720x480px60 720x586px50 1920x1080px25 1920x1080px30 3840x2160x30 3840x2160x25 Note: For best switching performance ensure that both inputs on the card have the same frame rate.	3840x2160x30

UHDS-OUT2-F16 Technical Specifications

PORTS:	2 HDMI
BANDWIDTH PER CHANNEL:	2.97Gbps per graphic channel
MAX DATA RATE:	8.91Gbps
MAX. SCALED OUTPUT RESOLUTION:	4K@30Hz (4:4:4)
MAX. INPUT RESOLUTION:	4K@30Hz (4:4:4)
MAXIMUM RANGE:	15m (49ft) – 1080p 12 bit (deep color)
SWITCHING TIME BETWEEN INPUTS:	Less than 1 second (seamless)
VIDEO LATENCY:	Less than 3 frames

OUTPUT RESOLUTIONS:	1920x1080p@60Hz, 1920x1080p@50Hz, 1280x720p@60Hz, 1280x720p@50Hz, 720x480p@60Hz, 720x586p@50Hz, 1920x1080p@25Hz, 1920x1080p@30Hz, 3840x2160@30Hz, 3840x2160@25Hz
STANDARDS COMPLIANCE:	HDCP 1.4, HDTV compatible
3D PASS THROUGH:	Not supported
POWER CONSUMPTION:	22W
OPERATING TEMPERATURE:	0° to +40°C (32° to 104°F)
STORAGE TEMPERATURE:	-40° to +70°C (-40° to 158°F)
HUMIDITY:	10% to 90%, RHL non-condensing
DIMENSIONS:	19cm x 13cm x 2cm (7.5" x 5.1" x 0.8") W, D, H
PRODUCT WEIGHT:	0.15 kg (0.33 lbs) approx.
SHIPPING WEIGHT:	0.3 kg (0.66 lbs) approx.
STANDARD COMPLIANCE:	HDCP 1.4, HDTV compatible
SAFETY REGULATORY COMPLIANCE:	CE
ENVIRONMENTAL REGULATORY COMPLIANCE:	Complies with appropriate requirements of RoHs and WEEE

Using the Test Module to Troubleshoot Video and Audio Problems

The VS-1616DN-EM includes a test module that acts as an AV signal generator and can be used to diagnose video and audio issues in an operating environment.



The test module supports analog audio and can only be used for testing analog audio problems.

Troubleshooting Video Problems

The test module may be used in various ways to isolate video problems.

The following examples are based on the video signal paths shown in [Figure 18](#) and a VS-1616DN-EM device installed as follows:

- 16 inputs and 16 outputs.
- The test module is installed and configured (see [Installing the Test Module](#) on page 41).
- 17 configured inputs and 17 configured outputs (see [Configuring the Number of Installed Input and Output Ports](#) on page 33).

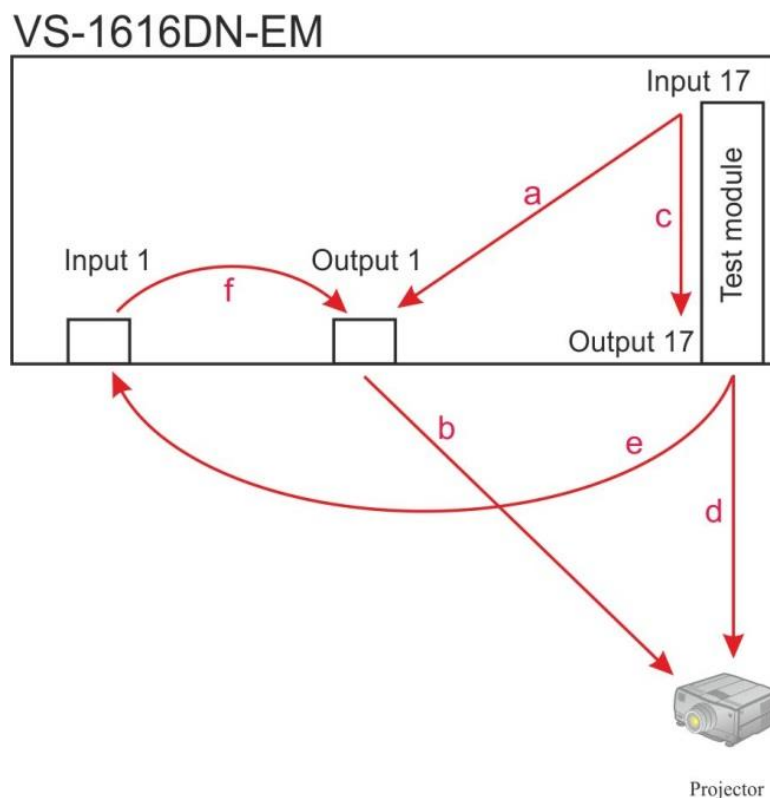

Figure 18: Signal Paths for Isolating Video Problems

Testing the Projector Output

Signal path: c to d; d to projector.

To test the projector output:

1. Configure Input 17 to Output 17 (see [Switching Actions](#) on page 19).
2. Connect Output 17 to the projector.
3. Set the generated video resolution (see [Setting the Resolution of the Generated Video](#) on page 40).
4. Set the pattern for the generated video (see [Setting the Pattern of the Generated Video](#) on page 40).
5. Verify that the projector output is as expected.

Testing the Output Signal Path to the Projector

Signal path: a to b; b to projector

To test the output signal path to the projector:

1. Configure Input 17 to Output 1 (see [Switching Actions](#) on page 19).
2. Connect Output 1 to the projector.
3. Set the generated video resolution (see [Setting the Resolution of the Generated Video](#) on page 40).
4. Set the pattern for the generated video (see [Setting the Pattern of the Generated Video](#) on page 40).
5. Verify that the projector output is as expected.

Testing the Input and Output Signal Path to the Projector

Signal path: c to e; e to f; f to b; b to projector.

To test the input and output signal path to the projector:

1. Configure Input 17 to Output 17 (see [Switching Actions](#) on page 19).
2. Connect Output 17 to Input 1.
3. Configure Input 1 to Output 1.
4. Connect Output 1 to the projector.
5. Set the generated video resolution (see [Setting the Resolution of the Generated Video](#) on page 40).
6. Set the pattern for the generated video (see [Setting the Pattern of the Generated Video](#) on page 40).
7. Verify that the projector output is as expected.

Troubleshooting Audio Problems

The test module may be used in various ways to isolate analog audio problems.

The following examples are based on the audio signal paths shown in [Figure 19](#) and a VS-1616DN-EM device installed as follows:

- 16 inputs and 16 outputs.
- The test module is installed and configured (see [Installing the Test Module](#) on page 41).
- 17 configured inputs and 17 configured outputs (see [Configuring the Number of Installed Input and Output Ports](#) on page 33).

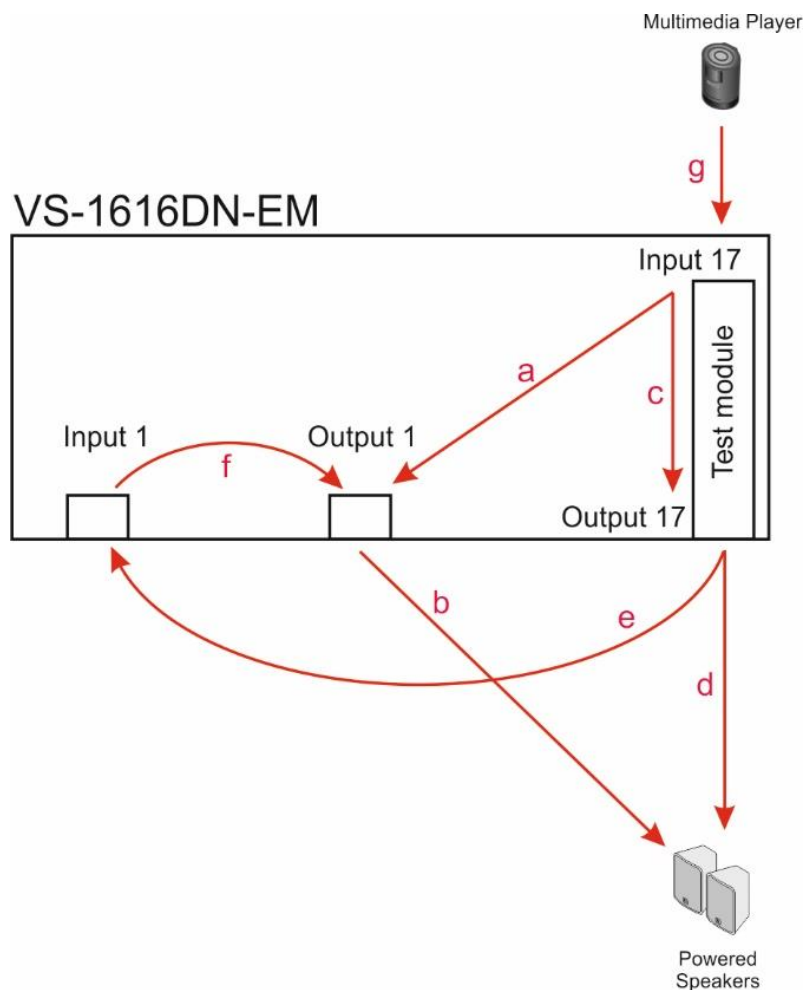

Figure 19: Signal Paths for Isolating Audio Problems

Testing the Audio Output

Signal path: g to c; c to d; d to an audio acceptor (for example, powered speakers).

To test the audio output:

1. Connect an analog audio source to Input 17.
2. Configure Input 17 to Output 17 (see [Switching Actions](#) on page 19).
3. Connect Output 17 to the audio acceptor.

4. Verify that the audio output is as expected.

Testing the Output Signal Path to the Audio Output

Signal path: g to a; a to b; b to an audio acceptor (for example, powered speakers).

To test the output signal path to the audio output:

1. Connect an analog audio source to Input 17.
2. Configure Input 17 to Output 1 (see [Switching Actions](#) on page [19](#)).
3. Connect Output 1 to the audio acceptor.
4. Verify that the audio output is as expected.

Testing the Input and Output Signal Path to the Audio Output

Signal path: g to c; c to e; e to f; f to b; b to an audio acceptor (for example, powered speakers).

To test the input and output signal path to the audio output:

1. Connect an analog audio source to Input 17.
2. Configure Input 17 to Output 17 (see [Switching Actions](#) on page [19](#)).
3. Connect Output 17 to Input 1.
4. Configure Input 1 to Output 1.
5. Connect Output 1 to the audio acceptor.
6. Verify that the audio output is as expected.

Input / Output Card Hardware Installation Instructions

The VS-1616DN-EM input / output cards mount in one of the 16 slots on the rear of the VS-1616DN-EM chassis. Slots are numbered from left to right (The process for inserting cards is the same for all cards / chassis and the figures below are for illustration purposes only.)



An input card must only be mounted in a slot designated for input cards (slots 1 to 4 and 9 to 12) and an output card must only be mounted in a slot designated for output cards (slots 5 to 8 and 13 to 16).

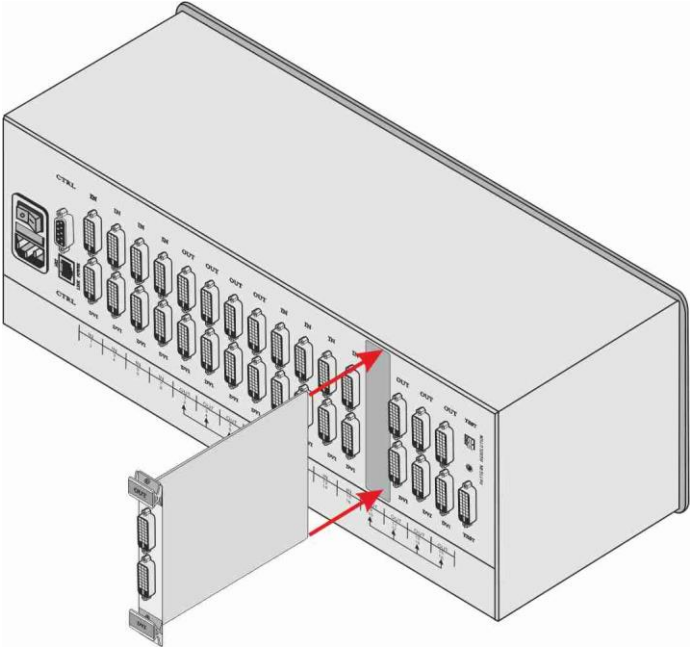

Figure 20: Inserting the Card into a Slot

To install an input / output card as shown in [Figure 20](#):

1. Power off the **VS-1616DN-EM** and all devices connected to it.
2. Using a Phillips screwdriver, loosen the screws at the top and bottom of the blanking plate (see [Figure 21](#)).

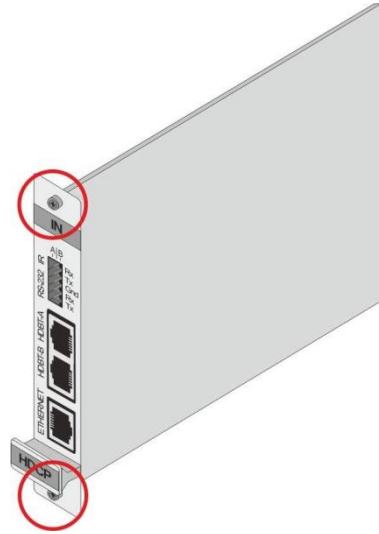

Figure 21: Card Handles

3. Remove the blanking plate from the slot and store it for possible future use.
4. Remove the new card from its shipping box and anti-ESD bag.
5. Holding the card by the lower handle, align the card with the plastic guide rails.
6. Slide the card into the chassis until the front of the card makes contact with the connector inside the chassis.
7. Press the card firmly into the slot until the connector plate is flush with the rear panel of the chassis and the connector is fully seated.
8. Using a Phillips screwdriver, tighten the retaining screws at the top and bottom of the card to secure it to the chassis.
9. Power on the **VS-1616DN-EM** and follow the procedure to configure the new card (see [Configuring the Number of Installed Input and Output Ports](#) on page [33](#)).
10. Power on the peripheral devices.

Replacing a FAN-16DN Fan Array

The **VS-1616DN-EM** is equipped with two **FAN-16DN** fan arrays that provide quiet and efficient cooling for the chassis. It is necessary to power down the chassis in order to replace a fan array.



When replacing a fan array, all normal static discharge precaution measures must be observed to prevent damage to the equipment.

For detailed instructions on replacing a fan array in your **VS-1616DN-EM**, see the **FAN-16DN** Fan Array Installation Instructions, available at www.kramerav.com.

Installing a PS-16DN Power Supply

The **VS-1616DN-EM** is equipped with a single **PS-16DN** power supply unit and includes an optional redundant power supply for mission critical installations. When two power supplies are installed, the **VS-1616DN-EM** distributes the load between the power supplies. Kramer recommends using two power supply units for extending power supply life-span.

The **PS-16DN** is a hot-swappable power supply. It is not necessary to power down the chassis in order to install or replace a second power supply.



When installing/replacing a power supply, all normal static discharge precaution measures must be observed to prevent damage to the equipment.

For detailed instructions on installing/replacing a power supply in your **VS-1616DN-EM**, see the **PS-16DN** Power Supply Installation Instructions, available at www.kramerav.com.

The following table describes the behavior of the PS-1 / PS-2 LEDs:

Event	Green POWER LED	Red ERROR LED
Device power on	Lights and remains on	Lights for a few seconds and turns off
Device power off	Remains on for ~20 seconds and then turns off	Lights for ~20 seconds and then turns off

If no LEDs light, verify the following:

- The power supply connector at the rear of the device is connected to the mains power supply (see [Defining the VS-1616DN-EM 2x2 to 16x16 Modular Multi-Format Managed Digital Matrix Switcher](#) on page 6).
- The power switch is switched to the On position.
- The power supply is seated firmly in place – the front panel of the power supply is flush with the front panel of the chassis and the screws are tightly fastened.

If the problem persists, or if the red ERROR LED is always lit, contact Kramer technical support.

Upgrading the VS-1616DN-EM Firmware

The VS-1616DN-EM enables upgrading both the device's firmware and that of the following input/output cards:

- DTAxr-IN2/OUT2-F16.
- UHDA-IN2/OUT2-F16.
- UHD-IN2/OUT2-F16.
- HDBT7-IN2/OUT2-F16.
- VGAA-IN2/OUT2-F16.

Upgrading the firmware of the remaining input / output cards can only be done by authorized service personnel.

The device and card firmware can be upgraded using:

- K-Upload via RS-232, USB (VCOM), or Ethernet (see [Upgrading Firmware Using K-Upload](#) on page 97).
- Kramer Network via Ethernet (see [Upgrading Firmware Using Kramer Network](#) on page 98).

Upgrading Firmware Using K-Upload

The VS-1616DN-EM enables upgrading device and card firmware via RS-232, USB (VCOM) or Ethernet using the K-Upload software application, available at www.kramerav.com/product/VS-1616DN-EM. For instructions on upgrading the firmware using K-Upload, see the *K-Upload User Manual*.

For information on connecting to the VS-1616DN-EM via RS-232, USB (VCOM), or Ethernet, see [Connecting to the VS-1616DN-EM via RS-232](#) on page 13, [Connecting to the VS-1616DN-EM via USB \(VCOM\)](#) on page 13, or [Connecting to the VS-1616DN-EM via Ethernet](#) on page 13, respectively.

Firmware may be available for any of the following components:



The firmware files for each component have different suffixes to help with identification.

- **VS-1616DN-EM Control Module** – Control module firmware files end with `_0`, for example:
`VS-163264_main_[APP_X_xx.xx_xxxxx]_0`
- **VS-1616DN-EM Test Module** – Test module firmware files end with `_200`, for example:
`16test_card_[OUT2_47_xx.xx_xxxxx]_200`
- **VS-1616DN-EM Keypad** – Keypad firmware files end with `_201`, for example:

VS-163264Keypad_[APP_X_xx.xx_xxxx]_201

- Supported Input / Output Cards – The suffix of card firmware files must be modified before use. Input and output card firmware files all end with `_N`, for example:

DTAxr_[OUT2_18_xx.xx_xxxx]_N

This suffix must be changed according to the slot number in which the card is installed (1-16). For example if the card is installed in slot 7, the firmware file's suffix must be changed to `_7`:

DTAxr_[OUT2_18_xx.xx_xxxx]_7



Go to www.kramerav.com/downloads/VS-1616DN-EM to check for up-to-date user manuals, application programs, and to check if firmware upgrades are available (where appropriate).

If necessary, you can downgrade the input/output card firmware by incrementing the previous firmware file's number to higher than the currently installed firmware. For example if you upgraded the card's firmware using the `DTAxr_[OUT2_18_01.00_0006]_8` file, to downgrade to the previously installed firmware, rename the previously installed firmware file to `DTAxr_[OUT2_18_01.00_0007]_8`.

Upgrading Firmware Using Kramer Network

The **VS-1616DN-EM** enables upgrading device and card firmware via Ethernet using the Kramer Network enterprise management platform, available at www.kramerav.com/product/VS-1616DN-EM. For instructions on upgrading the firmware using Kramer Network, see the *Kramer Network User Manual*.

For information on connecting to the **VS-1616DN-EM** via Ethernet, see [Connecting to the VS-1616DN-EM via Ethernet](#) on page 13.

Technical Specifications

VS-1616DN-EM Chassis

PORTS:	1 RS-232 on an 9-pin D-sub port 1 USB (VCOM) port on a USB Mini-B connector 1 Ethernet on an RJ-45 connector
BANDWIDTH:	Supports up to 3.4Gbps bandwidth per channel (limited by the card installed)
CONTROLS:	Front panel buttons, Infrared remote control transmitter, RS-232, Ethernet
SWITCHING:	Confirm or At Once for immediate switching
POWER CONSUMPTION:	100-240V AC, 50/60Hz, 1.5A
OPERATING TEMPERATURE:	0° to +40°C (32° to 104°F)
STORAGE TEMPERATURE:	-40° to +70°C (-40° to 158°F)
HUMIDITY:	10% to 90%, RHL non-condensing
COOLING:	Forced air, fan
ENCLOSURE TYPE:	Aluminum
RACK MOUNT:	With supplied rack ears, attached
DIMENSIONS:	19" 4U (43.7cm x 36cm x 17.7cm W, D, H)
PRODUCT WEIGHT:	6.7kg (14.8lbs) approx.
SHIPPING WEIGHT:	8kg (17.6lbs) approx.
VIBRATION:	ISTA 1A in carton (International Safe Transit Association)
SAFETY REGULATORY COMPLIANCE:	CE, FCC
ENVIRONMENTAL REGULATORY COMPLIANCE:	Complies with appropriate requirements of RoHs and WEEE
INCLUDED ACCESSORIES:	Power cord, Infrared remote control transmitter
Specifications are subject to change without notice at www.kramerav.com	

Quick VS-1616DN-EM Card Comparison

Card	Ports	BW per Channel	Max. Range	Compliance	3D Pass Thru
UHD	2 HDMI	2.97Gbps	10m (32ft) – 4K60 4:2:0 or 4K30 4:4:4 15m (49ft) – 1080p 12 bit (deep color)	HDCP 1.4, HDTV compatible	Yes
UHDA	2 HDMI 2 Analog audio on 3.5mm mini jacks	2.97Gbps	10m (32ft) – 4K60 4:2:0 or 4K30 4:4:4 15m (49ft) – 1080p 12 bit (deep color)	HDCP 1.4, HDTV compatible	Yes
HDBT	2 HDBaseT TP on RJ45 connectors 2 RS-232 Serial and 2 IR on a 10-pin terminal block 1 Ethernet on an RJ-45 connector	Vid: 2.25Gbps Serial: 115200	130m (430ft) normal mode 180m (590ft) ultra-mode (1080p@60Hz @24bpp)*	HDCP 1.4, HDBaseT	Yes
HDBT7	2 HDBaseT TP on RJ45 connectors 2 RS-232 Serial on a 10-pin terminal block 2 IR ports on 3.5mm jacks	Vid: 3.4Gbps Serial: 115200	40m (130ft) – 4K @60Hz 4:2:0 or 4K @30Hz 4:4:4 70m (230ft) – 1080p 12 bit (deep color)	HDCP 1.4, HDBaseT, HDTV compatible	Yes
DTAxr	2 HDBaseT TP on RJ45 connectors 2 RS-232 Serial ports, 2 IR ports, and 2 analog audio ports on a 16-pin terminal block 1 Ethernet port on an RJ45 connector	Vid: 3.4Gbps Serial: 115200	100m (330ft) – normal mode (4K @60Hz 4:2:0 or 4K @30Hz 4:4:4) 130m (430ft) – normal mode (2K) 180m (590ft) – ultra-mode (1080p @60Hz @24bpp)*	HDCP 1.4, HDBaseT, HDTV compatible	Yes
HH	2 HDMI	2.25Gbps	15m (49ft)	HDCP 1.4	Yes
HS (Out)	2 HDMI	2.25Gbps	15m (49ft) – 1080p 12 bit (deep color)	HDCP 1.4, HDTV compatible	No
UHDS	2 HDMI	2.97Gbps	15m (49ft) – 1080p 12 bit (deep color)	HDCP 1.4, HDTV compatible	
HAD	2 HDMI 2 Digital audio on RCA connectors	2.25Gbps	15m (49ft)	HDCP 1.4	Yes
HAA	2 HDMI 2 Analog audio on 3.5mm mini jacks	2.25Gbps	15m (49ft)	HDCP 1.4	Yes
HDCP	2 DVI-D on a DVI Molex 24-pin (F) connector	2.25Gbps	15m (49ft)	HDCP, HDMI	Yes
DGKat	2 TP DGKat on RJ-45 2 Serial on 3-pin terminal blocks	Vid: 1.65Gbps Serial: 19200	90m (300ft) – 1080p @60Hz*	HDCP 1.4, HDMI	Yes

Card	Ports	BW per Channel	Max. Range	Compliance	3D Pass Thru
F670	2 SC	2.25Gbps	1700m (5570ft) – 1080p/60Hz	HDCP 1.4, HDMI	Yes
F610	2 4 LC	1.65Gbps	400m (1310ft) using MM OM2 fiber	DVI 1.0	No
DVI	2 DVI-D on DVI Molex 24-pin (F) connectors	1.65Gbps	15m (49ft)	DVI 1.0	No
DL	1 DVI-D on a DVI Molex 24-pin (F) connector	3.3Gbps	15m (49ft)	DVI 1.0	No
SDIA (In)	2 unbalanced analog audio on 3.5mm mini jack connectors 2 SDI, 75Ω on BNC connectors	3Gbps	300m (980ft) – SD 200m (655ft) – HD 1080p 90m (295ft) – 3G 1080p	-	No
VGA	2 VGA on 15-pin HD connectors	450MHz	10m (32ft)	-	-
VGAA	2 VGA on 15-pin HD connectors 2 unbalanced analog audio on 3.5mm mini jack connectors**	450MHz	10m (32ft)	-	-
AAD	2 S/PDIF (digital audio) on RCA connectors 2 balanced audio stereo (analog audio) on 5-pin terminal blocks	-	-	-	-
<p>* When using BC-UNIKAT cables.</p> <p>** Accessible via C-GF/GMAF-30 cables.</p> <p>Specifications are subject to change without notice at www.kramerav.com</p>					

Default Settings

Default Communication Parameters

EDID	
EDID data is passed between Output 1 and Input 1	
RS-232 / Protocol 3000	
Baud Rate:	115200
Data Bits:	8
Stop Bits:	1
Parity:	None
Command Format:	HEX
Command Example to Switch Input 4 to Output 2:	#VID 4>2
Ethernet	
IP Address:	192.168.1.39
TCP Port #:	5000
UDP Port#	50000
Concurrent TCP Connections:	32

Factory Default EDID

UHD-IN2-F16 / UHD-OUT2-F16

Monitor
 Model name..... VS-16UHD
 Manufacturer..... KMR
 Plug and Play ID..... KMR0200
 Serial number..... 1
 Manufacture date..... 2015, ISO week 50
 Filter driver..... None

 EDID revision..... 1.3
 Input signal type..... Digital (HDMI-a)
 Color bit depth..... Undefined
 Display type..... RGB color
 Screen size..... 700 x 390 mm (31.5 in)
 Power management..... Not supported
 Extension blocs..... 1 (CEA-EXT)

 DDC/CI..... Not supported
 Color characteristics
 Default color space..... Non-sRGB
 Display gamma..... 2.20
 Red chromaticity..... Rx 0.640 - Ry 0.341
 Green chromaticity..... Gx 0.286 - Gy 0.610
 Blue chromaticity..... Bx 0.146 - By 0.069
 White point (default).... Wx 0.284 - Wy 0.293
 Additional descriptors... None
 Timing characteristics
 Horizontal scan range.... 31-94kHz
 Vertical scan range..... 50-85Hz
 Video bandwidth..... 170MHz
 CVT standard..... Not supported
 GTF standard..... Not supported
 Additional descriptors... None
 Preferred timing..... Yes
 Native/preferred timing.. 1280x720p at 60Hz
 Modeline..... "1280x720" 74.250 1280 1390 1430 1650 720 725 730 750 +hsync +vsync
 Detailed timing #1..... 1920x1080p at 60Hz (16:9)
 Modeline..... "1920x1080" 148.500 1920 2008 2052 2200 1080 1084 1089 1125 +hsync +vsync
 Standard timings supported
 720 x 400p at 70Hz - IBM VGA
 720 x 400p at 88Hz - IBM XGA2
 640 x 480p at 60Hz - IBM VGA
 640 x 480p at 67Hz - Apple Mac II
 640 x 480p at 72Hz - VESA
 640 x 480p at 75Hz - VESA
 800 x 600p at 56Hz - VESA
 800 x 600p at 60Hz - VESA
 800 x 600p at 72Hz - VESA
 800 x 600p at 75Hz - VESA
 832 x 624p at 75Hz - Apple Mac II
 1024 x 768i at 87Hz - IBM
 1024 x 768p at 60Hz - VESA
 1024 x 768p at 70Hz - VESA

1024 x 768p at 75Hz - VESA
 1280 x 1024p at 75Hz - VESA
 1152 x 870p at 75Hz - Apple Mac II
 1280 x 720p at 60Hz - VESA STD
 1280 x 800p at 60Hz - VESA STD
 1440 x 900p at 60Hz - VESA STD
 1280 x 960p at 60Hz - VESA STD
 1280 x 1024p at 60Hz - VESA STD
 1400 x 1050p at 60Hz - VESA STD
 1680 x 1050p at 60Hz - VESA STD
 1600 x 1200p at 60Hz - VESA STD
EIA/CEA-861 Information
 Revision number..... 3
 IT underscan..... Not supported
 Basic audio..... Supported
 YCbCr 4:4:4..... Not supported
 YCbCr 4:2:2..... Not supported
 Native formats..... 1
Detailed timing #1..... 720x480p at 60Hz (4:3)
 Modeline..... "720x480" 27.000 720 736 798 858 480 489 495 525 -hsync -vsync
Detailed timing #2..... 1920x1080i at 60Hz (16:9)
 Modeline..... "1920x1080" 74.250 1920 2008 2052 2200 1080 1084 1094 1124 interface +hsync +vsync
Detailed timing #3..... 1920x1080i at 50Hz (16:9)
 Modeline..... "1920x1080" 74.250 1920 2448 2492 2640 1080 1084 1094 1124 interface +hsync +vsync
Detailed timing #4..... 1280x720p at 60Hz (16:9)
 Modeline..... "1280x720" 74.250 1280 1390 1430 1650 720 725 730 750 +hsync +vsync
Detailed timing #5..... 1280x720p at 50Hz (16:9)
 Modeline..... "1280x720" 74.250 1280 1720 1760 1980 720 725 730 750 +hsync +vsync
CE video identifiers (VICs) - timing/formats supported
 720 x 576p at 50Hz - EDTV (4:3, 16:15)
 1280 x 720p at 50Hz - HDTV (16:9, 1:1)
 1920 x 1080i at 60Hz - HDTV (16:9, 1:1)
 1920 x 1080i at 50Hz - HDTV (16:9, 1:1)
 1280 x 720p at 60Hz - HDTV (16:9, 1:1) [Native]
 1920 x 1080p at 60Hz - HDTV (16:9, 1:1)
 1920 x 1080p at 50Hz - HDTV (16:9, 1:1)
 NB: NTSC refresh rate = (Hz*1000)/1001
CE audio data (formats supported)
 LPCM 2-channel, 24-bits at 44/48 kHz
CE speaker allocation data
 Channel configuration.... 2.0
 Front left/right..... Yes
 Front LFE..... No
 Front center..... No
 Rear left/right..... No
 Rear center..... No
 Front left/right center... No
 Rear left/right center... No
 Rear LFE..... No
CE vendor specific data (VSDB)
 IEEE registration number. 0x000C03
 CEC physical address..... 1.0.0.0
 Maximum TMDS clock..... 165MHz
Report information
 Date generated..... 11/04/2016
 Software revision..... 2.70.0.989
 Data source..... Real-time 0x0071
 Operating system..... 6.1.7601.2.Service Pack 1
Raw data
 00,FF,FF,FF,FF,FF,FF,00,2D,B2,00,02,01,00,00,00,32,19,01,03,82,46,27,78,0A,D5,7C,A3,57,49,9C,25,
 11,48,4B,FF,FF,80,81,C0,81,00,95,00,81,40,81,80,90,40,B3,00,A9,40,01,1D,00,72,51,D0,1E,20,6E,28,
 55,00,7E,88,42,00,00,1E,02,3A,80,18,71,38,2D,40,58,2C,45,00,C4,8E,21,00,00,1E,00,00,00,FC,00,56,
 53,2D,31,36,55,48,44,0A,20,20,20,00,00,00,FD,00,32,55,1F,5E,11,00,0A,20,20,20,20,01,63,
 02,03,1A,41,47,11,13,05,14,84,10,1F,23,09,06,04,83,01,00,00,65,03,0C,00,10,00,8C,0A,D0,8A,20,E0,
 2D,10,10,3E,96,00,58,C2,21,00,00,18,01,1D,80,18,71,1C,16,20,58,2C,25,00,C4,8E,21,00,00,9E,01,1D,
 80,D0,72,1C,16,20,10,2C,25,80,C4,8E,21,00,00,9E,01,1D,00,72,51,D0,1E,20,6E,28,55,00,C4,8E,21,00,
 00,1E,01,1D,00,BC,52,D0,1E,20,B8,28,55,40,C4,8E,21,00,00,1E,00,00,00,00,00,00,00,00,00,00,C5

UHDA-IN2-F16 / UHDA-OUT2-F16

Monitor
 Model name..... VS-16UHDA
 Manufacturer..... KMR
 Plug and Play ID..... KMR0200
 Serial number..... 1
 Manufacture date..... 2015, ISO week 50
 Filter driver..... None

 EDID revision..... 1.3
 Input signal type..... Digital (HDMI-a)
 Color bit depth..... Undefined
 Display type..... RGB color
 Screen size..... 700 x 390 mm (31.5 in)
 Power management..... Not supported
 Extension blocs..... 1 (CEA-EXT)

 DDC/CI..... Supported
 MCCS revision..... 2.0
 Display technology..... TFT
 Controller..... Genesis 0x10000
 Firmware revision..... 9.0
 Firmware flags..... 0x006645CC
 Active power on time..... Not supported
 Power consumption..... Not supported
 Current frequency..... 74.10kHz, 60.00Hz
Color characteristics
 Default color space..... Non-sRGB
 Display gamma..... 2.20
 Red chromaticity..... Rx 0.640 - Ry 0.341
 Green chromaticity..... Gx 0.286 - Gy 0.610
 Blue chromaticity..... Bx 0.146 - By 0.069
 White point (default)... Wx 0.284 - Wy 0.293
 Additional descriptors... None
Timing characteristics

Horizontal scan range.... 31-94kHz
 Vertical scan range..... 50-85Hz
 Video bandwidth..... 170MHz
 CVT standard..... Not supported
 GTF standard..... Not supported
 Additional descriptors... None
 Preferred timing..... Yes
 Native/preferred timing.. 1280x720p at 60Hz
 Modeline..... "1280x720" 74.250 1280 1390 1430 1650 720 725 730 750 +hsync +vsync
 Detailed timing #1..... 1920x1080p at 60Hz (16:9)
 Modeline..... "1920x1080" 148.500 1920 2008 2052 2200 1080 1084 1089 1125 +hsync +vsync
Standard timings supported
 720 x 400p at 70Hz - IBM VGA
 720 x 400p at 88Hz - IBM XGA2
 640 x 480p at 60Hz - IBM VGA
 640 x 480p at 67Hz - Apple Mac II
 640 x 480p at 72Hz - VESA
 640 x 480p at 75Hz - VESA
 800 x 600p at 56Hz - VESA
 800 x 600p at 60Hz - VESA
 800 x 600p at 72Hz - VESA
 800 x 600p at 75Hz - VESA
 832 x 624p at 75Hz - Apple Mac II
 1024 x 768i at 87Hz - IBM
 1024 x 768p at 60Hz - VESA
 1024 x 768p at 70Hz - VESA
 1024 x 768p at 75Hz - VESA
 1280 x 1024p at 75Hz - VESA
 1152 x 870p at 75Hz - Apple Mac II
 1280 x 720p at 60Hz - VESA STD
 1280 x 800p at 60Hz - VESA STD
 1440 x 900p at 60Hz - VESA STD
 1280 x 960p at 60Hz - VESA STD
 1280 x 1024p at 60Hz - VESA STD
 1400 x 1050p at 60Hz - VESA STD
 1680 x 1050p at 60Hz - VESA STD
 1600 x 1200p at 60Hz - VESA STD
EIA/CEA-861 Information
 Revision number..... 3
 IT underscan..... Not supported
 Basic audio..... Supported
 YCbCr 4:4:4..... Not supported
 YCbCr 4:2:2..... Not supported
 Native formats..... 1
 Detailed timing #1..... 720x480p at 60Hz (4:3)
 Modeline..... "720x480" 27.000 720 736 798 858 480 489 495 525 -hsync -vsync
 Detailed timing #2..... 1920x1080i at 60Hz (16:9)
 Modeline..... "1920x1080i" 74.250 1920 2008 2052 2200 1080 1084 1094 1124 interface +hsync +vsync
 Detailed timing #3..... 1920x1080i at 50Hz (16:9)
 Modeline..... "1920x1080i" 74.250 1920 2448 2492 2640 1080 1084 1094 1124 interface +hsync +vsync
 Detailed timing #4..... 1280x720p at 60Hz (16:9)
 Modeline..... "1280x720" 74.250 1280 1390 1430 1650 720 725 730 750 +hsync +vsync
 Detailed timing #5..... 1280x720p at 50Hz (16:9)
 Modeline..... "1280x720" 74.250 1280 1720 1760 1980 720 725 730 750 +hsync +vsync
CE video identifiers (VICs) - timing/formats supported
 720 x 576p at 50Hz - EDTV (4:3, 16:15)
 1280 x 720p at 50Hz - HDTV (16:9, 1:1)
 1920 x 1080i at 60Hz - HDTV (16:9, 1:1)
 1920 x 1080i at 50Hz - HDTV (16:9, 1:1)
 1280 x 720p at 60Hz - HDTV (16:9, 1:1) [Native]
 1920 x 1080p at 60Hz - HDTV (16:9, 1:1)
 1920 x 1080p at 50Hz - HDTV (16:9, 1:1)
 NB: NTSC refresh rate = (Hz*1000)/1001
CE audio data (formats supported)
 LPCM 2-channel, 24-bits at 44/48 kHz
CE speaker allocation data
 Channel configuration.... 2.0
 Front left/right..... Yes
 Front LFE..... No
 Front center..... No
 Rear left/right..... No
 Rear center..... No
 Front left/right center... No
 Rear left/right center... No
 Rear LFE..... No
CE vendor specific data (VSDB)
 IEEE registration number. 0x000C03
 CEC physical address.... 1.0.0.0
 Maximum TMDS clock..... 165MHz
Report information
 Date generated..... 10/02/2016
 Software revision..... 2.90.0.1002
 Data source..... Real-time 0x0071
 Operating system..... 6.1.7601.2.Service Pack 1
Raw data
 00,FF,FF,FF,FF,FF,FF,00,2D,B2,00,02,01,00,00,00,32,19,01,03,82,46,27,78,0A,D5,7C,A3,57,49,9C,25,
 11,48,4B,FF,FF,80,81,C0,81,00,95,00,81,40,81,80,90,40,B3,00,A9,40,01,1D,00,72,51,D0,1E,20,6E,28,
 55,00,7E,88,42,00,00,1E,02,3A,80,18,71,38,2D,40,58,2C,45,00,C4,8E,21,00,00,1E,00,00,00,FC,00,56,
 53,2D,31,36,55,48,44,41,0A,20,20,20,00,00,00,FD,00,32,55,1F,5E,11,00,0A,20,20,20,20,20,01,42,
 02,03,1A,41,47,11,13,05,14,84,10,1F,23,09,06,04,83,01,00,00,65,03,0C,00,10,00,8C,0A,D0,8A,20,E0,
 2D,10,10,3E,96,00,58,C2,21,00,00,18,01,1D,80,18,71,1C,16,20,58,2C,25,00,C4,8E,21,00,00,9E,01,1D,
 80,D0,72,1C,16,20,10,2C,25,80,C4,8E,21,00,00,9E,01,1D,00,72,51,D0,1E,20,6E,28,55,00,C4,8E,21,00,
 00,1E,01,1D,00,BC,52,D0,1E,20,B8,28,55,40,C4,8E,21,00,00,1E,00,00,00,00,00,00,00,00,00,00,00,C5

HDBT-IN2-F16 / HDBT-OUT2-F16

Monitor
 Model name..... VS-16HDBaseT
 Manufacturer..... KMR
 Plug and Play ID..... KMR1200
 Serial number..... 295-883450100
 Manufacture date..... 2014, ISO week 255
 Filter driver..... None

EDID revision..... 1.3
 Input signal type..... Digital
 Color bit depth..... Undefined
 Display type..... Monochrome/grayscale
 Screen size..... 520 x 320 mm (24.0 in)
 Power management..... Standby, Suspend, Active off/sleep
 Extension blocs..... 1 (CEA-EXT)

 DDC/CI..... Not supported

Color characteristics
 Default color space..... Non-sRGB
 Display gamma..... 2.20
 Red chromaticity..... Rx 0.674 - Ry 0.319
 Green chromaticity..... Gx 0.188 - Gy 0.706
 Blue chromaticity..... Bx 0.148 - By 0.064
 White point (default).... Wx 0.313 - Wy 0.329
 Additional descriptors... None

Timing characteristics
 Horizontal scan range.... 30-83kHz
 Vertical scan range..... 56-76Hz
 Video bandwidth..... 170MHz
 CVT standard..... Not supported
 GTF standard..... Not supported
 Additional descriptors... None
 Preferred timing..... Yes
 Native/preferred timing.. 1280x720p at 60Hz (16:10)
 Modeline..... "1280x720" 74.250 1280 1390 1430 1650 720 725 730 750 +hsync +vsync

Standard timings supported
 720 x 400p at 70Hz - IBM VGA
 720 x 400p at 88Hz - IBM XGA2
 640 x 480p at 60Hz - IBM VGA
 640 x 480p at 67Hz - Apple Mac II
 640 x 480p at 72Hz - VESA
 640 x 480p at 75Hz - VESA
 800 x 600p at 56Hz - VESA
 800 x 600p at 60Hz - VESA
 800 x 600p at 72Hz - VESA
 800 x 600p at 75Hz - VESA
 832 x 624p at 75Hz - Apple Mac II
 1024 x 768i at 87Hz - IBM
 1024 x 768p at 60Hz - VESA
 1024 x 768p at 70Hz - VESA
 1024 x 768p at 75Hz - VESA
 1280 x 1024p at 75Hz - VESA
 1152 x 870p at 75Hz - Apple Mac II
 1280 x 1024p at 75Hz - VESA STD
 1280 x 1024p at 85Hz - VESA STD
 1600 x 1200p at 60Hz - VESA STD
 1024 x 768p at 85Hz - VESA STD
 800 x 600p at 85Hz - VESA STD
 640 x 480p at 85Hz - VESA STD
 1152 x 864p at 70Hz - VESA STD
 1280 x 960p at 60Hz - VESA STD

EIA/CEA-861 Information
 Revision number..... 3
 IT underscan..... Supported
 Basic audio..... Supported
 YCbCr 4:4:4..... Not supported
 YCbCr 4:2:2..... Not supported
 Native formats..... 1

Detailed timing #1..... 1920x1080p at 60Hz (16:10)
 Modeline..... "1920x1080" 148.500 1920 2008 2052 2200 1080 1084 1089 1125 +hsync +vsync
 Detailed timing #2..... 1920x1080i at 60Hz (16:10)
 Modeline..... "1920x1080i" 74.250 1920 2008 2052 2200 1080 1084 1094 1124 interface +hsync +vsync
 Detailed timing #3..... 1280x720p at 60Hz (16:10)
 Modeline..... "1280x720" 74.250 1280 1390 1430 1650 720 725 730 750 +hsync +vsync
 Detailed timing #4..... 720x480p at 60Hz (16:10)
 Modeline..... "720x480" 27.000 720 736 798 858 480 489 525 -hsync -vsync

CE audio data (formats supported)
 LPCM 2-channel, 16/20/24 bit depths at 32/44/48 kHz

CE video identifiers (VICs) - timing/formats supported
 1920 x 1080p at 60Hz - HDTV (16:9, 1:1)
 1920 x 1080i at 60Hz - HDTV (16:9, 1:1)
 1280 x 720p at 60Hz - HDTV (16:9, 1:1) [Native]
 720 x 480p at 60Hz - EDTV (16:9, 32:27)
 720 x 480p at 60Hz - EDTV (4:3, 8:9)
 720 x 480i at 60Hz - Doublescan (16:9, 32:27)
 720 x 576i at 50Hz - Doublescan (16:9, 64:45)
 640 x 480p at 60Hz - Default (4:3, 1:1)
 NB: NTSC refresh rate = (Hz*1000)/1001

CE vendor specific data (VSDB)
 IEEE registration number. 0x000C03
 CEC physical address..... 1.0.0.0
 Maximum TMDS clock..... 165MHz

CE speaker allocation data
 Channel configuration.... 2.0
 Front left/right..... Yes
 Front LFE..... No
 Front center..... No
 Rear left/right..... No
 Rear center..... No
 Front left/right center... No
 Rear left/right center... No
 Rear LFE..... No

Report information
 Date generated..... 17/01/2017
 Software revision..... 2.70.0.989
 Data source..... Real-time 0x0071
 Operating system..... 6.1.7601.2.Service Pack 1

Raw data
 00,FF,FF,FF,FF,FF,FF,00,2D,B2,00,12,01,01,01,01,FF,18,01,03,80,34,20,78,E2,B3,25,AC,51,30,B4,26,
 10,50,54,FF,FF,80,81,8F,81,99,A9,40,61,59,45,59,31,59,71,4A,81,40,01,1D,00,72,51,D0,1E,20,6E,28,
 55,00,07,44,21,00,00,1E,00,00,00,FF,00,32,39,35,2D,38,38,33,34,35,30,31,30,30,00,00,00,FC,00,56,
 53,2D,31,36,48,44,42,61,73,65,54,0A,00,00,00,FD,00,38,4C,1E,53,11,00,0A,20,20,20,20,20,01,DD,
 02,03,1B,C1,23,09,07,07,48,10,05,84,03,02,07,16,01,65,03,0C,00,10,00,83,01,00,00,02,3A,80,18,71,
 38,2D,40,58,2C,45,00,07,44,21,00,00,1E,01,1D,80,18,71,1C,16,20,58,2C,25,00,07,44,21,00,00,9E,01,

Native formats..... 1
Detailed timing #1..... 720x480p at 60Hz (4:3)
Modeline..... "720x480" 27.000 720 736 798 858 480 489 495 525 -hsync -vsync
Detailed timing #2..... 1920x1080i at 60Hz (16:9)
Modeline..... "1920x1080" 74.250 1920 2008 2052 2200 1080 1084 1094 1124 interface +hsync +vsync
Detailed timing #3..... 1920x1080i at 50Hz (16:9)
Modeline..... "1920x1080" 74.250 1920 2448 2492 2640 1080 1084 1094 1124 interface +hsync +vsync
Detailed timing #4..... 1280x720p at 60Hz (16:9)
Modeline..... "1280x720" 74.250 1280 1390 1430 1650 720 725 730 750 +hsync +vsync
Detailed timing #5..... 1280x720p at 50Hz (16:9)
Modeline..... "1280x720" 74.250 1280 1720 1760 1980 720 725 730 750 +hsync +vsync
CE video identifiers (VICs) - timing/formats supported
720 x 576p at 50Hz - EDTV (4:3, 16:15)
1280 x 720p at 50Hz - HDTV (16:9, 1:1)
1920 x 1080i at 60Hz - HDTV (16:9, 1:1)
1920 x 1080i at 50Hz - HDTV (16:9, 1:1)
1280 x 720p at 60Hz - HDTV (16:9, 1:1) [Native]
1920 x 1080p at 60Hz - HDTV (16:9, 1:1)
1920 x 1080p at 50Hz - HDTV (16:9, 1:1)
NB: NTSC refresh rate = (Hz*1000)/1001
CE audio data (formats supported)
LPCM 3-channel, 24-bits at 44/48 kHz
CE speaker allocation data
Channel configuration.... 3.0
Front left/right..... Yes
Front LFE..... No
Front center..... Yes
Rear left/right..... No
Rear center..... No
Front left/right center.. No
Rear left/right center... No
Rear LFE..... No
CE vendor specific data (VSDB)
IEEE registration number. 0x000C03
CEC physical address..... 1.0.0.0
Maximum TMDS clock..... 165MHz
Report information
Date generated..... 24/12/2015
Software revision..... 2.90.0.1002
Data source..... Real-time 0x0071
Operating system..... 6.1.7601.2.Service Pack 1
Raw data
00,FF,FF,FF,FF,FF,FF,00,2D,B2,00,02,01,00,00,00,13,18,01,03,82,46,27,78,0A,D5,7C,A3,57,49,9C,25,
11,48,4B,FF,FF,80,81,C0,81,00,95,00,81,40,81,80,90,40,B3,00,A9,40,01,1D,00,72,51,D0,1E,20,6E,28,
55,00,7E,88,42,00,00,1E,02,3A,80,18,71,38,2D,40,58,2C,45,00,C4,8E,21,00,00,1E,00,00,00,FC,00,56,
53,2D,31,36,48,48,0A,20,20,20,20,20,00,00,00,FD,00,32,55,1F,5E,11,00,0A,20,20,20,20,20,01,B4,
02,03,1A,71,47,11,13,05,14,84,10,1F,23,0A,06,04,83,05,00,00,65,03,0C,00,10,00,8C,0A,D0,8A,20,E0,
2D,10,10,3E,96,00,58,C2,21,00,00,18,01,1D,80,18,71,1C,16,20,58,2C,25,00,C4,8E,21,00,00,9E,01,1D,
80,D0,72,1C,16,20,10,2C,25,80,C4,8E,21,00,00,9E,01,1D,00,72,51,D0,1E,20,6E,28,55,00,C4,8E,21,00,
00,1E,01,1D,00,BC,52,D0,1E,20,B8,28,55,40,C4,8E,21,00,00,1E,00,00,00,00,00,00,00,00,00,00,00,90

HAD-IN2-F16 / HAD-OUT2-F16

Monitor
Model name..... VS-16HAD
Manufacturer..... KMR
Plug and Play ID..... KMR0200
Serial number..... 1
Manufacture date..... 2014, ISO week 19
Filter driver..... None

EDID revision..... 1.3
Input signal type..... Digital (HDMI-a)
Color bit depth..... Undefined
Display type..... RGB color
Screen size..... 700 x 390 mm (31.5 in)
Power management..... Not supported
Extension blocs..... 1 (CEA-EXT)

DDC/CI..... Not supported
Color characteristics
Default color space..... Non-sRGB
Display gamma..... 2.20
Red chromaticity..... Rx 0.640 - Ry 0.341
Green chromaticity..... Gx 0.286 - Gy 0.610
Blue chromaticity..... Bx 0.146 - By 0.069
White point (default)... Wx 0.284 - Wy 0.293
Additional descriptors... None
Timing characteristics
Horizontal scan range.... 31-94kHz
Vertical scan range..... 50-85Hz
Video bandwidth..... 170MHz
CVT standard..... Not supported
GTF standard..... Not supported
Additional descriptors... None
Preferred timing..... Yes
Native/preferred timing.. 1280x720p at 60Hz
Modeline..... "1280x720" 74.250 1280 1390 1430 1650 720 725 730 750 +hsync +vsync
Detailed timing #1..... 1920x1080p at 60Hz (16:9)
Modeline..... "1920x1080" 148.500 1920 2008 2052 2200 1080 1084 1089 1125 +hsync +vsync
Standard timings supported
720 x 400p at 70Hz - IBM VGA
720 x 400p at 88Hz - IBM XGA2
640 x 480p at 60Hz - IBM VGA
640 x 480p at 67Hz - Apple Mac II
640 x 480p at 72Hz - VESA
640 x 480p at 75Hz - VESA
800 x 600p at 56Hz - VESA
800 x 600p at 60Hz - VESA
800 x 600p at 72Hz - VESA
800 x 600p at 75Hz - VESA
832 x 624p at 75Hz - Apple Mac II
1024 x 768i at 87Hz - IBM
1024 x 768p at 60Hz - VESA

1024 x 768p at 70Hz - VESA
 1024 x 768p at 75Hz - VESA
 1280 x 1024p at 75Hz - VESA
 1152 x 870p at 75Hz - Apple Mac II
 1280 x 720p at 60Hz - VESA STD
 1280 x 800p at 60Hz - VESA STD
 1440 x 900p at 60Hz - VESA STD
 1280 x 960p at 60Hz - VESA STD
 1280 x 1024p at 60Hz - VESA STD
 1400 x 1050p at 60Hz - VESA STD
 1680 x 1050p at 60Hz - VESA STD
 1600 x 1200p at 60Hz - VESA STD
 EIA/CEA-861 Information
 Revision number..... 3
 IT underscan..... Not supported
 Basic audio..... Supported
 YCbCr 4:4:4..... Supported
 YCbCr 4:2:2..... Supported
 Native formats..... 1
 Detailed timing #1..... 720x480p at 60Hz (4:3)
 Modeline..... "720x480" 27.000 720 736 798 858 480 489 495 525 -hsync -vsync
 Detailed timing #2..... 1920x1080i at 60Hz (16:9)
 Modeline..... "1920x1080" 74.250 1920 2008 2052 2200 1080 1084 1094 1124 interface +hsync +vsync
 Detailed timing #3..... 1920x1080i at 50Hz (16:9)
 Modeline..... "1920x1080" 74.250 1920 2448 2492 2640 1080 1084 1094 1124 interface +hsync +vsync
 Detailed timing #4..... 1280x720p at 60Hz (16:9)
 Modeline..... "1280x720" 74.250 1280 1390 1430 1650 720 725 730 750 +hsync +vsync
 Detailed timing #5..... 1280x720p at 50Hz (16:9)
 Modeline..... "1280x720" 74.250 1280 1720 1760 1980 720 725 730 750 +hsync +vsync
 CE video identifiers (VICs) - timing/formats supported
 720 x 576p at 50Hz - EDTV (4:3, 16:15)
 1280 x 720p at 50Hz - HDTV (16:9, 1:1)
 1920 x 1080i at 60Hz - HDTV (16:9, 1:1)
 1920 x 1080i at 50Hz - HDTV (16:9, 1:1)
 1280 x 720p at 60Hz - HDTV (16:9, 1:1) [Native]
 1920 x 1080p at 60Hz - HDTV (16:9, 1:1)
 1920 x 1080p at 50Hz - HDTV (16:9, 1:1)
 NB: NTSC refresh rate = (Hz*1000)/1001
 CE audio data (formats supported)
 LPCM 3-channel, 24-bits at 44/48 kHz
 CE speaker allocation data
 Channel configuration.... 3.0
 Front left/right..... Yes
 Front LFE..... No
 Front center..... Yes
 Rear left/right..... No
 Rear center..... No
 Front left/right center.. No
 Rear left/right center... No
 Rear LFE..... No
 CE vendor specific data (VSDb)
 IEEE registration number. 0x000C03
 CEC physical address..... 1.0.0.0
 Maximum TMDS clock..... 165MHz
 Report information
 Date generated..... 24/12/2015
 Software revision..... 2.90.0.1002
 Data source..... Real-time 0x0071
 Operating system..... 6.1.7601.2.Service Pack 1
 Raw data
 00,FF,FF,FF,FF,FF,00,2D,B2,00,02,01,00,00,00,13,18,01,03,82,46,27,78,0A,D5,7C,A3,57,49,9C,25,
 11,48,4B,FF,FF,80,81,C0,81,00,95,00,81,40,81,80,90,40,B3,00,A9,40,01,1D,00,72,51,D0,1E,20,6E,28,
 55,00,7E,88,42,00,00,1E,02,3A,80,18,71,38,2D,40,58,2C,45,00,C4,8E,21,00,00,1E,00,00,00,FC,00,56,
 53,2D,31,36,48,41,44,0A,20,20,20,20,00,00,00,FD,00,32,55,1F,5E,11,00,0A,20,20,20,20,20,01,97,
 02,03,1A,71,47,11,13,05,14,84,10,1F,23,0A,06,04,83,05,00,00,65,03,0C,00,10,00,8C,0A,D0,8A,20,E0,
 2D,10,10,3E,96,00,58,C2,21,00,00,18,01,1D,80,18,71,1C,16,20,58,2C,25,00,C4,8E,21,00,00,9E,01,1D,
 80,D0,72,1C,16,20,10,2C,25,80,C4,8E,21,00,00,9E,01,1D,00,72,51,D0,1E,20,6E,28,55,00,C4,8E,21,00,
 00,1E,01,1D,00,BC,52,D0,1E,20,B8,28,55,40,C4,8E,21,00,00,1E,00,00,00,00,00,00,00,00,00,00,00,90

HAA-IN2-F16 / HAA-OUT2-F16

Monitor
 Model name..... VS-16HAA
 Manufacturer..... KMR
 Plug and Play ID..... KMR0200
 Serial number..... 1
 Manufacture date..... 2014, ISO week 19
 Filter driver..... None

 EDID revision..... 1.3
 Input signal type..... Digital (HDMI-a)
 Color bit depth..... Undefined
 Display type..... RGB color
 Screen size..... 700 x 390 mm (31.5 in)
 Power management..... Not supported
 Extension blocs..... 1 (CEA-EXT)

 DDC/CI..... Not supported
 Color characteristics
 Default color space..... Non-sRGB
 Display gamma..... 2.20
 Red chromaticity..... Rx 0.640 - Ry 0.341
 Green chromaticity..... Gx 0.286 - Gy 0.610
 Blue chromaticity..... Bx 0.146 - By 0.069
 White point (default)... Wx 0.284 - Wy 0.293
 Additional descriptors... None
 Timing characteristics
 Horizontal scan range... 31-94kHz
 Vertical scan range..... 50-85Hz
 Video bandwidth..... 170MHz
 CVT standard..... Not supported
 GTF standard..... Not supported
 Additional descriptors... None
 Preferred timing..... Yes

Native/preferred timing.. 1280x720p at 60Hz
 Modeline..... "1280x720" 74.250 1280 1390 1430 1650 720 725 730 750 +hsync +vsync
 Detailed timing #1..... 1920x1080p at 60Hz (16:9)
 Modeline..... "1920x1080" 148.500 1920 2008 2052 2200 1080 1084 1089 1125 +hsync +vsync

Standard timings supported
 720 x 400p at 70Hz - IBM VGA
 720 x 400p at 88Hz - IBM XGA2
 640 x 480p at 60Hz - IBM VGA
 640 x 480p at 67Hz - Apple Mac II
 640 x 480p at 72Hz - VESA
 640 x 480p at 75Hz - VESA
 800 x 600p at 56Hz - VESA
 800 x 600p at 60Hz - VESA
 800 x 600p at 72Hz - VESA
 800 x 600p at 75Hz - VESA
 832 x 624p at 75Hz - Apple Mac II
 1024 x 768i at 87Hz - IBM
 1024 x 768p at 60Hz - VESA
 1024 x 768p at 70Hz - VESA
 1024 x 768p at 75Hz - VESA
 1280 x 1024p at 75Hz - VESA
 1152 x 870p at 75Hz - Apple Mac II
 1280 x 720p at 60Hz - VESA STD
 1280 x 800p at 60Hz - VESA STD
 1440 x 900p at 60Hz - VESA STD
 1280 x 960p at 60Hz - VESA STD
 1280 x 1024p at 60Hz - VESA STD
 1400 x 1050p at 60Hz - VESA STD
 1680 x 1050p at 60Hz - VESA STD
 1600 x 1200p at 60Hz - VESA STD

EIA/CEA-861 Information
 Revision number..... 3
 IT underscan..... Not supported
 Basic audio..... Supported
 YCbCr 4:4:4..... Supported
 YCbCr 4:2:2..... Supported
 Native formats..... 1
 Detailed timing #1..... 720x480p at 60Hz (4:3)
 Modeline..... "720x480" 27.000 720 736 798 858 480 489 495 525 -hsync -vsync
 Detailed timing #2..... 1920x1080i at 60Hz (16:9)
 Modeline..... "1920x1080i" 74.250 1920 2008 2052 2200 1080 1084 1094 1124 interface +hsync +vsync
 Detailed timing #3..... 1920x1080i at 50Hz (16:9)
 Modeline..... "1920x1080i" 74.250 1920 2448 2492 2640 1080 1084 1094 1124 interface +hsync +vsync
 Detailed timing #4..... 1280x720p at 60Hz (16:9)
 Modeline..... "1280x720" 74.250 1280 1390 1430 1650 720 725 730 750 +hsync +vsync
 Detailed timing #5..... 1280x720p at 50Hz (16:9)
 Modeline..... "1280x720" 74.250 1280 1760 1980 720 725 730 750 +hsync +vsync

CE video identifiers (VICs) - timing/formats supported
 720 x 576p at 50Hz - EDTV (4:3, 16:15)
 1280 x 720p at 50Hz - HDTV (16:9, 1:1)
 1920 x 1080i at 60Hz - HDTV (16:9, 1:1)
 1920 x 1080i at 50Hz - HDTV (16:9, 1:1)
 1280 x 720p at 60Hz - HDTV (16:9, 1:1) [Native]
 1920 x 1080p at 60Hz - HDTV (16:9, 1:1)
 1920 x 1080p at 50Hz - HDTV (16:9, 1:1)
 NB: NTSC refresh rate = (Hz*1000)/1001

CE audio data (formats supported)
 LPCM 3-channel, 24-bits at 44/48 kHz

CE speaker allocation data
 Channel configuration.... 3.0
 Front left/right..... Yes
 Front LFE..... No
 Front center..... Yes
 Rear left/right..... No
 Rear center..... No
 Front left/right center... No
 Rear left/right center... No
 Rear LFE..... No

CE vendor specific data (VSDB)
 IEEE registration number. 0x000C03
 CEC physical address..... 1.0.0.0
 Maximum TMDS clock..... 165MHz

Report information
 Date generated..... 24/12/2015
 Software revision..... 2.90.0.1002
 Data source..... Real-time 0x0071
 Operating system..... 6.1.7601.2.Service Pack 1

Raw data
 00,FF,FF,FF,FF,FF,FF,00,2D,B2,00,02,01,00,00,00,13,18,01,03,82,46,27,78,0A,D5,7C,A3,57,49,9C,25,
 11,48,4B,FF,FF,FF,80,81,C0,81,00,95,00,81,40,81,80,90,40,B3,00,A9,40,01,1D,00,72,51,D0,1E,20,6E,28,
 55,00,7E,88,42,00,00,1E,02,3A,80,18,71,38,2D,40,58,2C,45,00,C4,8E,21,00,00,1E,00,00,00,FC,00,56,
 53,2D,31,36,48,41,41,0A,20,20,20,00,00,00,FD,00,32,55,1F,5E,11,00,0A,20,20,20,20,01,9A,
 02,03,1A,71,47,11,13,05,14,84,10,1F,23,0A,06,04,83,05,00,00,65,03,0C,00,10,00,8C,0A,D0,8A,20,E0,
 2D,10,10,3E,96,00,58,C2,21,00,00,18,01,1D,80,18,71,1C,16,20,58,2C,25,00,C4,8E,21,00,00,9E,01,1D,
 80,D0,72,1C,16,20,10,2C,25,80,C4,8E,21,00,00,9E,01,1D,00,72,51,D0,1E,20,6E,28,55,00,C4,8E,21,00,
 00,1E,01,1D,00,BC,52,D0,1E,20,B8,28,55,40,C4,8E,21,00,00,1E,00,00,00,00,00,00,00,00,00,00,90

HDCCP-IN2-F16 / HDCCP-OUT2-F16

Monitor
 Model name..... VS-16HDCCP
 Manufacturer..... KMR
 Plug and Play ID..... KMR0200
 Serial number..... 1
 Manufacture date..... 2013, ISO week 12
 Filter driver..... None

 EDID revision..... 1.3
 Input signal type..... Digital (DVI)
 Color bit depth..... Undefined
 Display type..... RGB color
 Screen size..... 700 x 390 mm (31.5 in)
 Power management..... Not supported
 Extension blocs..... 1 (CEA-EXT)

```

-----
DDC/CI..... Not supported
Color characteristics
Default color space..... Non-sRGB
Display gamma..... 2.20
Red chromaticity..... Rx 0.640 - Ry 0.341
Green chromaticity..... Gx 0.286 - Gy 0.610
Blue chromaticity..... Bx 0.146 - By 0.069
White point (default)... Wx 0.284 - Wy 0.293
Additional descriptors... None
Timing characteristics
Horizontal scan range.... 31-94kHz
Vertical scan range..... 50-85Hz
Video bandwidth..... 170MHz
CVT standard..... Not supported
GTF standard..... Not supported
Additional descriptors... None
Preferred timing..... Yes
Native/preferred timing.. 1280x720p at 60Hz
Modeline..... "1280x720" 74.250 1280 1390 1430 1650 720 725 730 750 +hsync -vsync
Detailed timing #1..... 1920x1080p at 60Hz (16:9)
Modeline..... "1920x1080" 148.500 1920 2008 2052 2200 1080 1084 1089 1125 +hsync +vsync
Standard timings supported
720 x 400p at 70Hz - IBM VGA
720 x 400p at 88Hz - IBM XGA2
640 x 480p at 60Hz - IBM VGA
640 x 480p at 67Hz - Apple Mac II
640 x 480p at 72Hz - VESA
640 x 480p at 75Hz - VESA
800 x 600p at 56Hz - VESA
800 x 600p at 60Hz - VESA
800 x 600p at 72Hz - VESA
800 x 600p at 75Hz - VESA
832 x 624p at 75Hz - Apple Mac II
1024 x 768i at 87Hz - IBM
1024 x 768p at 60Hz - VESA
1024 x 768p at 70Hz - VESA
1024 x 768p at 75Hz - VESA
1280 x 1024p at 75Hz - VESA
1152 x 870p at 75Hz - Apple Mac II
1280 x 720p at 60Hz - VESA STD
1280 x 800p at 60Hz - VESA STD
1440 x 900p at 60Hz - VESA STD
1280 x 960p at 60Hz - VESA STD
1280 x 1024p at 60Hz - VESA STD
1400 x 1050p at 60Hz - VESA STD
1680 x 1050p at 60Hz - VESA STD
1600 x 1200p at 60Hz - VESA STD
EIA/CEA-861 Information
Revision number..... 3
IT underscan..... Not supported
Basic audio..... Supported
YCbCr 4:4:4..... Supported
YCbCr 4:2:2..... Supported
Native formats..... 1
Detailed timing #1..... 720x480p at 60Hz (4:3)
Modeline..... "720x480" 27.000 720 736 798 858 480 489 495 525 -hsync -vsync
Detailed timing #2..... 1920x1080i at 60Hz (16:9)
Modeline..... "1920x1080" 74.250 1920 2008 2052 2200 1080 1084 1094 1124 interface +hsync +vsync
Detailed timing #3..... 1920x1080i at 50Hz (16:9)
Modeline..... "1920x1080" 74.250 1920 2448 2492 2640 1080 1084 1094 1124 interface +hsync +vsync
Detailed timing #4..... 1280x720p at 60Hz (16:9)
Modeline..... "1280x720" 74.250 1280 1390 1430 1650 720 725 730 750 +hsync +vsync
Detailed timing #5..... 1280x720p at 50Hz (16:9)
Modeline..... "1280x720" 74.250 1280 1720 1760 1980 720 725 730 750 +hsync +vsync
CE video identifiers (VICs) - timing/formats supported
720 x 576p at 50Hz - EDTV (4:3, 16:15)
1280 x 720p at 50Hz - HDTV (16:9, 1:1)
1920 x 1080i at 60Hz - HDTV (16:9, 1:1)
1920 x 1080i at 50Hz - HDTV (16:9, 1:1)
1280 x 720p at 60Hz - HDTV (16:9, 1:1) [Native]
1920 x 1080p at 60Hz - HDTV (16:9, 1:1)
1920 x 1080p at 50Hz - HDTV (16:9, 1:1)
NB: NTSC refresh rate = (Hz*1000)/1001
CE audio data (formats supported)
LPCM 3-channel, 24-bits at 44/48 kHz
CE speaker allocation data
Channel configuration... 3.0
Front left/right..... Yes
Front LFE..... No
Front center..... Yes
Rear left/right..... No
Rear center..... No
Front left/right center.. No
Rear left/right center... No
Rear LFE..... No
CE vendor specific data (VSDB)
IEEE registration number. 0x000C03
CEC physical address..... 1.0.0.0
Maximum TMDS clock..... 165MHz
Report information
Date generated..... 30/04/2014
Software revision..... 2.70.0.989
Data source..... Real-time 0x0071
Operating system..... 6.1.7601.2.Service Pack 1
Raw data
00,FF,FF,FF,FF,FF,FF,00,2D,B2,00,02,01,00,00,00,0C,17,01,03,81,46,27,78,0A,D5,7C,A3,57,49,9C,25,
11,48,4B,FF,FF,FF,FF,00,81,C0,81,00,95,00,81,40,81,80,90,40,B3,00,A9,40,01,1D,00,72,51,D0,1E,20,6E,28,
55,00,7E,88,42,00,00,1A,02,3A,80,18,71,38,2D,40,58,2C,45,00,C4,8E,21,00,00,1E,00,00,00,FC,00,56,
53,2D,31,36,48,44,43,50,0A,20,20,20,00,00,00,FD,00,32,55,1F,5E,11,00,0A,20,20,20,20,20,01,72,
02,03,1A,71,47,11,13,05,14,84,10,1F,23,0A,06,04,83,05,00,00,65,03,0C,00,10,00,8C,0A,D0,8A,20,E0,
2D,10,10,3E,96,00,58,C2,21,00,00,18,01,1D,80,18,71,1C,16,20,58,2C,25,00,C4,8E,21,00,00,9E,01,1D,
80,D0,72,1C,16,20,10,2C,25,80,C4,8E,21,00,00,9E,01,1D,00,72,51,D0,1E,20,6E,28,55,00,C4,8E,21,00,
00,1E,01,1D,00,BC,52,D0,1E,20,B8,28,55,40,C4,8E,21,00,00,1E,00,00,00,00,00,00,00,00,00,00,00,90

```

DGKat-IN2-F16 / DGKat-OUT2-F16

```

Monitor
Model name..... VS-16hCat5e
Manufacturer..... KMR
Plug and Play ID..... KMR0200
Serial number..... 1
Manufacture date..... 2014, ISO week 19
Filter driver..... None
-----
EDID revision..... 1.3
Input signal type..... Digital (DVI)
Color bit depth..... Undefined
Display type..... RGB color
Screen size..... 700 x 390 mm (31.5 in)
Power management..... Not supported
Extension blocs..... 1 (CEA-EXT)
-----
DDC/CI..... Not supported
Color characteristics
Default color space..... Non-sRGB
Display gamma..... 2.20
Red chromaticity..... Rx 0.640 - Ry 0.341
Green chromaticity..... Gx 0.286 - Gy 0.610
Blue chromaticity..... Bx 0.146 - By 0.069
White point (default).... Wx 0.284 - Wy 0.293
Additional descriptors... None
Timing characteristics
Horizontal scan range.... 31-94kHz
Vertical scan range..... 50-85Hz
Video bandwidth..... 170MHz
CVT standard..... Not supported
GTF standard..... Not supported
Additional descriptors... None
Preferred timing..... Yes
Native/preferred timing.. 1280x720p at 60Hz
Modeline..... "1280x720" 74.250 1280 1390 1430 1650 720 725 730 750 +hsync +vsync
Detailed timing #1 ..... 1920x1080p at 60Hz (16:9)
Modeline..... "1920x1080" 148.500 1920 2008 2052 2200 1080 1084 1089 1125 +hsync +vsync
Standard timings supported
720 x 400p at 70Hz - IBM VGA
720 x 400p at 88Hz - IBM XGA2
640 x 480p at 60Hz - IBM VGA
640 x 480p at 67Hz - Apple Mac II
640 x 480p at 72Hz - VESA
640 x 480p at 75Hz - VESA
800 x 600p at 56Hz - VESA
800 x 600p at 60Hz - VESA
800 x 600p at 72Hz - VESA
800 x 600p at 75Hz - VESA
832 x 624p at 75Hz - Apple Mac II
1024 x 768i at 87Hz - IBM
1024 x 768p at 60Hz - VESA
1024 x 768p at 70Hz - VESA
1024 x 768p at 75Hz - VESA
1280 x 1024p at 75Hz - VESA
1152 x 870p at 75Hz - Apple Mac II
1280 x 720p at 60Hz - VESA STD
1280 x 800p at 60Hz - VESA STD
1440 x 900p at 60Hz - VESA STD
1280 x 960p at 60Hz - VESA STD
1280 x 1024p at 60Hz - VESA STD
1400 x 1050p at 60Hz - VESA STD
1680 x 1050p at 60Hz - VESA STD
1600 x 1200p at 60Hz - VESA STD
EIA/CEA-861 Information
Revision number..... 3
IT underscan..... Not supported
Basic audio..... Supported
YCbCr 4:4:4..... Supported
YCbCr 4:2:2..... Supported
Native formats..... 1
Detailed timing #1 ..... 720x480p at 60Hz (4:3)
Modeline..... "720x480" 27.000 720 736 798 858 480 489 495 525 -hsync -vsync
Detailed timing #2..... 1920x1080i at 60Hz (16:9)
Modeline..... "1920x1080i" 74.250 1920 2008 2052 2200 1080 1084 1094 1124 interface +hsync +vsync
Detailed timing #3..... 1920x1080i at 50Hz (16:9)
Modeline..... "1920x1080i" 74.250 1920 2448 2492 2640 1080 1084 1094 1124 interface +hsync +vsync
Detailed timing #4..... 1280x720p at 60Hz (16:9)
Modeline..... "1280x720" 74.250 1280 1390 1430 1650 720 725 730 750 +hsync +vsync
Detailed timing #5..... 1280x720p at 50Hz (16:9)
Modeline..... "1280x720" 74.250 1280 1720 1760 1980 720 725 730 750 +hsync +vsync
CE video identifiers (VICs) - timing/formats supported
720 x 576p at 50Hz - EDTV (4:3, 16:15)
1280 x 720p at 50Hz - HDTV (16:9, 1:1)
1920 x 1080i at 60Hz - HDTV (16:9, 1:1)
1920 x 1080i at 50Hz - HDTV (16:9, 1:1)
1280 x 720p at 60Hz - HDTV (16:9, 1:1) [Native]
1920 x 1080p at 60Hz - HDTV (16:9, 1:1)
1920 x 1080p at 50Hz - HDTV (16:9, 1:1)
NB: NTSC refresh rate = (Hz*1000)/1001
CE audio data (formats supported)
LPCM 3-channel, 24-bits at 44/48 kHz
CE speaker allocation data
Channel configuration... 3.0
Front left/right..... Yes
Front LFE..... No
Front center..... Yes
Rear left/right..... No
Rear center..... No
Front left/right center... No
Rear left/right center... No
Rear LFE..... No
CE vendor specific data (VSDb)

```

IEEE registration number. 0x000C03
 CEC physical address..... 1.0.0.0
 Maximum TMDS clock..... 165MHz
 Report information
 Date generated..... 6/17/2014
 Software revision..... 2.90.0.1000
 Data source..... Real-time 0x0071
 Operating system..... 6.1.7601.2.Service Pack 1
 Raw data
 00,FF,FF,FF,FF,FF,FF,00,2D,B2,00,02,01,00,00,00,13,18,01,03,81,46,27,78,0A,D5,7C,A3,57,49,9C,25,
 11,48,4B,FF,FF,80,81,C0,81,00,95,00,81,40,81,80,90,40,B3,00,A9,40,01,1D,00,72,51,D0,1E,20,6E,28,
 55,00,7E,88,42,00,00,1E,02,3A,80,18,71,38,2D,40,58,2C,45,00,C4,8E,21,00,00,1E,00,00,00,FC,00,56,
 53,2D,31,36,68,43,61,74,35,65,0A,20,00,00,00,FD,00,32,55,1F,5E,11,00,0A,20,20,20,20,20,01,AB,
 02,03,1A,71,47,11,13,05,14,84,10,1F,23,0A,06,04,83,05,00,00,65,03,0C,00,10,00,8C,0A,D0,8A,20,E0,
 2D,10,10,3E,96,00,58,C2,21,00,00,18,01,1D,80,18,71,1C,16,20,58,2C,25,00,C4,8E,21,00,00,9E,01,1D,
 80,D0,72,1C,16,20,10,2C,25,80,C4,8E,21,00,00,9E,01,1D,00,72,51,D0,1E,20,6E,28,55,00,C4,8E,21,00,
 00,1E,01,1D,00,BC,52,D0,1E,20,B8,28,55,40,C4,8E,21,00,00,1E,00,00,00,00,00,00,00,00,00,00,90

F670-IN2-F16 / F670-OUT2-F16

Monitor
 Model name..... VS-16hOmron
 Manufacturer..... KMR
 Plug and Play ID..... KMR0200
 Serial number..... 1
 Manufacture date..... 2013, ISO week 12
 Filter driver..... None

 EDID revision..... 1.3
 Input signal type..... Digital (DVI)
 Color bit depth..... Undefined
 Display type..... RGB color
 Screen size..... 700 x 390 mm (31.5 in)
 Power management..... Not supported
 Extension blocs..... 1 (CEA-EXT)

 DDC/CI..... Not supported
 Color characteristics
 Default color space..... Non-sRGB
 Display gamma..... 2.20
 Red chromaticity..... Rx 0.640 - Ry 0.341
 Green chromaticity..... Gx 0.286 - Gy 0.610
 Blue chromaticity..... Bx 0.146 - By 0.069
 White point (default).... Wx 0.284 - Wy 0.293
 Additional descriptors... None
 Timing characteristics
 Horizontal scan range.... 31-94kHz
 Vertical scan range..... 50-85Hz
 Video bandwidth..... 170MHz
 CVT standard..... Not supported
 GTF standard..... Not supported
 Additional descriptors... None
 Preferred timing..... Yes
 Native/preferred timing.. 1280x720p at 60Hz
 Modeline..... "1280x720" 74.250 1280 1390 1430 1650 720 725 730 750 +hsync -vsync
 Detailed timing #1..... 1920x1080p at 60Hz (16:9)
 Modeline..... "1920x1080" 148.500 1920 2008 2052 2200 1080 1084 1089 1125 +hsync +vsync
 Standard timings supported
 720 x 400p at 70Hz - IBM VGA
 720 x 400p at 88Hz - IBM XGA2
 640 x 480p at 60Hz - IBM VGA
 640 x 480p at 67Hz - Apple Mac II
 640 x 480p at 72Hz - VESA
 640 x 480p at 75Hz - VESA
 800 x 600p at 56Hz - VESA
 800 x 600p at 60Hz - VESA
 800 x 600p at 72Hz - VESA
 800 x 600p at 75Hz - VESA
 832 x 624p at 75Hz - Apple Mac II
 1024 x 768i at 87Hz - IBM
 1024 x 768p at 60Hz - VESA
 1024 x 768p at 70Hz - VESA
 1024 x 768p at 75Hz - VESA
 1280 x 1024p at 75Hz - VESA
 1152 x 870p at 75Hz - Apple Mac II
 1280 x 720p at 60Hz - VESA STD
 1280 x 800p at 60Hz - VESA STD
 1440 x 900p at 60Hz - VESA STD
 1280 x 960p at 60Hz - VESA STD
 1280 x 1024p at 60Hz - VESA STD
 1400 x 1050p at 60Hz - VESA STD
 1680 x 1050p at 60Hz - VESA STD
 1600 x 1200p at 60Hz - VESA STD
 EIA/CEA-861 Information
 Revision number..... 3
 IT underscan..... Not supported
 Basic audio..... Supported
 YCbCr 4:4:4..... Supported
 YCbCr 4:2:2..... Supported
 Native formats..... 1
 Detailed timing #1..... 720x480p at 60Hz (4:3)
 Modeline..... "720x480" 27.000 720 736 798 858 480 489 495 525 -hsync -vsync
 Detailed timing #2..... 1920x1080i at 60Hz (16:9)
 Modeline..... "1920x1080" 74.250 1920 2008 2052 2200 1080 1084 1094 1124 interface +hsync +vsync
 Detailed timing #3..... 1920x1080i at 50Hz (16:9)
 Modeline..... "1920x1080" 74.250 1920 2448 2492 2640 1080 1084 1094 1124 interface +hsync +vsync
 Detailed timing #4..... 1280x720p at 60Hz (16:9)
 Modeline..... "1280x720" 74.250 1280 1390 1430 1650 720 725 730 750 +hsync +vsync
 Detailed timing #5..... 1280x720p at 50Hz (16:9)
 Modeline..... "1280x720" 74.250 1280 1720 1760 1980 720 725 730 750 +hsync +vsync
 CE video identifiers (VICs) - timing/formats supported
 720 x 576p at 50Hz - EDTV (4:3, 16:15)
 1280 x 720p at 50Hz - HDTV (16:9, 1:1)
 1920 x 1080i at 60Hz - HDTV (16:9, 1:1)

1920 x 1080i at 50Hz - HDTV (16:9, 1:1)
 1280 x 720p at 60Hz - HDTV (16:9, 1:1) [Native]
 1920 x 1080p at 60Hz - HDTV (16:9, 1:1)
 1920 x 1080p at 50Hz - HDTV (16:9, 1:1)
 NB: NTSC refresh rate = (Hz*1000)/1001
 CE audio data (formats supported)
 LPCM 3-channel, 24-bits at 44/48 kHz
 CE speaker allocation data
 Channel configuration.... 3.0
 Front left/right..... Yes
 Front LFE..... No
 Front center..... Yes
 Rear left/right..... No
 Rear center..... No
 Front left/right center.. No
 Rear left/right center... No
 Rear LFE..... No
 CE vendor specific data (VSDB)
 IEEE registration number. 0x000C03
 CEC physical address..... 1.0.0.0
 Maximum TMDS clock..... 165MHz
 Report information
 Date generated..... 30/04/2014
 Software revision..... 2.70.0.989
 Data source..... Real-time 0x0071
 Operating system..... 6.1.7601.2.Service Pack 1
 Raw data
 00,FF,FF,FF,FF,FF,FF,00,2D,B2,00,02,01,00,00,00,0C,17,01,03,81,46,27,78,0A,D5,7C,A3,57,49,9C,25,
 11,48,4B,FF,FF,80,81,C0,81,00,95,00,81,40,81,80,90,40,B3,00,A9,40,01,1D,00,72,51,D0,1E,20,6E,28,
 55,00,7E,88,42,00,00,1A,02,3A,80,18,71,38,2D,40,58,2C,45,00,C4,8E,21,00,00,1E,00,00,00,FC,00,56,
 53,2D,31,36,68,4F,6D,72,6F,6E,0A,20,00,00,00,FD,00,32,55,1F,5E,11,00,0A,20,20,20,20,20,01,5E,
 02,03,1A,71,47,11,13,05,14,84,10,1F,23,0A,06,04,83,05,00,00,65,03,0C,00,10,00,8C,0A,D0,8A,20,E0,
 2D,10,10,3E,96,00,58,C2,21,00,00,18,01,1D,80,18,71,1C,16,20,58,2C,25,00,C4,8E,21,00,00,9E,01,1D,
 80,D0,72,1C,16,20,10,2C,25,80,C4,8E,21,00,00,9E,01,1D,00,72,51,D0,1E,20,6E,28,55,00,C4,8E,21,00,
 00,1E,01,1D,00,BC,52,D0,1E,20,B8,28,55,40,C4,8E,21,00,00,1E,00,00,00,00,00,00,00,00,00,00,00,90

DL-IN1-F16 / DL-OUT1-F16

Monitor
 Model name..... VS-16DUAL
 Manufacturer..... KMR
 Plug and Play ID..... KMR0200
 Serial number..... 1
 Manufacture date..... 2006, ISO week 12
 Filter driver..... None

 EDID revision..... 1.3
 Input signal type..... Digital (DVI)
 Color bit depth..... Undefined
 Display type..... RGB color
 Screen size..... 700 x 390 mm (31.5 in)
 Power management..... Not supported
 Extension blocs..... None

 DDC/CI..... n/a
 Color characteristics
 Default color space..... Non-sRGB
 Display gamma..... 2.20
 Red chromaticity..... Rx 0.640 - Ry 0.341
 Green chromaticity..... Gx 0.286 - Gy 0.610
 Blue chromaticity..... Bx 0.146 - By 0.069
 White point (default).... Wx 0.284 - Wy 0.293
 Additional descriptors... None
 Timing characteristics
 Horizontal scan range.... 31-94kHz
 Vertical scan range..... 50-85Hz
 Video bandwidth..... 170MHz
 CVT standard..... Not supported
 GTF standard..... Not supported
 Additional descriptors... None
 Preferred timing..... Yes
 Native/preferred timing.. 1024x768p at 60Hz (4:3)
 Modeline..... "1024x768" 65.000 1024 1048 1184 1344 768 771 777 806 +hsync +vsync
 Detailed timing #1..... 1920x1200p at 60Hz (16:10)
 Modeline..... "1920x1200" 154.000 1920 1968 2000 2080 1200 1203 1209 1235 +hsync -vsync
 Standard timings supported
 720 x 400p at 70Hz - IBM VGA
 720 x 400p at 88Hz - IBM XGA2
 640 x 480p at 60Hz - IBM VGA
 640 x 480p at 67Hz - Apple Mac II
 640 x 480p at 72Hz - VESA
 640 x 480p at 75Hz - VESA
 800 x 600p at 56Hz - VESA
 800 x 600p at 60Hz - VESA
 800 x 600p at 72Hz - VESA
 800 x 600p at 75Hz - VESA
 832 x 624p at 75Hz - Apple Mac II
 1024 x 768i at 87Hz - IBM
 1024 x 768p at 60Hz - VESA
 1024 x 768p at 70Hz - VESA
 1024 x 768p at 75Hz - VESA
 1280 x 1024p at 75Hz - VESA
 1152 x 870p at 75Hz - Apple Mac II
 1360 x 765p at 60Hz - VESA STD
 1280 x 800p at 60Hz - VESA STD
 1440 x 900p at 60Hz - VESA STD
 1280 x 960p at 60Hz - VESA STD
 1280 x 1024p at 60Hz - VESA STD
 1400 x 1050p at 60Hz - VESA STD
 1680 x 1050p at 60Hz - VESA STD
 1600 x 1200p at 60Hz - VESA STD
 EIA/CEA-861 Information
 Revision number..... 3
 IT underscan..... Not supported

1280 x 960p at 60Hz - VESA STD
 1280 x 1024p at 60Hz - VESA STD
 1400 x 1050p at 60Hz - VESA STD
 1680 x 1050p at 60Hz - VESA STD
 1600 x 1200p at 60Hz - VESA STD

Raw data

00,FF,FF,FF,FF,FF,FF,FF,00,2E,4D,00,02,01,00,00,00,0C,10,01,03,81,46,27,78,0A,D5,7C,A3,57,49,9C,25,11,48,4B,FF,FF,80,8B,C0,81,00,95,00,81,40,81,80,90,40,B3,00,A9,40,0E,1F,00,80,51,00,1E,30,40,80,37,00,6F,13,11,00,00,1E,28,3C,80,A0,70,B0,23,40,30,20,36,00,06,44,21,00,00,1A,00,00,00,FC,00,56,53,2D,33,32,44,56,49,53,0A,20,20,20,00,00,00,FD,00,32,55,1F,5E,11,00,0A,20,20,20,20,20,20,00,39

VGA-IN2-F16 / VGA-OUT2-F16

Monitor Asset Manager Report, generated 07/01/2014
 Copyright (c) 1995-2013, EnTech Taiwan.

Monitor #2 [Real-time 0x0061]

Model name..... VGA-IN2-F16
 Manufacturer..... KMR
 Plug and Play ID..... KMR040B
 Serial number..... 17056
 Manufacture date..... 2011, ISO week 48
 Filter driver..... None

EDID revision..... 1.3
 Input signal type..... Analog 0.700,0.300 (1.0V p-p)
 Sync input support..... Not available
 Display type..... RGB color
 Screen size..... 700 x 390 mm (31.5 in)
 Power management..... Not supported
 Extension blocs..... None

DDC/CI..... Not supported

Color characteristics

Default color space..... Non-sRGB
 Display gamma..... 2.20
 Red chromaticity..... Rx 0.640 - Ry 0.341
 Green chromaticity..... Gx 0.286 - Gy 0.610
 Blue chromaticity..... Bx 0.146 - By 0.069
 White point (default).... Wx 0.284 - Wy 0.293
 Additional descriptors... None

Timing characteristics

Range limits..... Not available
 GTF standard..... Supported
 Additional descriptors... None
 Preferred timing..... Yes
 Native/preferred timing.. 640x480p at 60Hz (4:3)
 Modeline..... "640x480" 25,180 640 656 752 800 480 490 492 525 -hsync -vsync
 Detailed timing #1..... 1920x1080p at 60Hz (16:9)
 Modeline..... "1920x1080" 148,500 1920 2008 2052 2200 1080 1084 1089 1125 +hsync +vsync
 Detailed timing #2..... 1600x1200p at 60Hz (4:3)
 Modeline..... "1600x1200" 162,000 1600 1664 1856 2160 1200 1201 1204 1250 +hsync +vsync

Standard timings supported

720 x 400p at 70Hz - IBM VGA
 720 x 400p at 88Hz - IBM XGA2
 640 x 480p at 60Hz - IBM VGA
 640 x 480p at 67Hz - Apple Mac II
 640 x 480p at 72Hz - VESA
 640 x 480p at 75Hz - VESA
 800 x 600p at 56Hz - VESA
 800 x 600p at 60Hz - VESA
 800 x 600p at 72Hz - VESA
 800 x 600p at 75Hz - VESA
 832 x 624p at 75Hz - Apple Mac II
 1024 x 768i at 87Hz - IBM
 1024 x 768p at 60Hz - VESA
 1024 x 768p at 70Hz - VESA
 1024 x 768p at 75Hz - VESA
 1280 x 1024p at 75Hz - VESA
 1152 x 870p at 75Hz - Apple Mac II
 640 x 480p at 60Hz - VESA STD
 800 x 600p at 60Hz - VESA STD
 1024 x 768p at 60Hz - VESA STD
 1152 x 864p at 75Hz - VESA STD
 1280 x 1024p at 75Hz - VESA STD
 1280 x 960p at 60Hz - VESA STD
 1280 x 1024p at 60Hz - VESA STD
 1360 x 765p at 60Hz - VESA STD

Report information

Date generated..... 07/01/2014
 Software revision..... 2.70.0.989
 Data source..... Real-time 0x0061
 Operating system..... 5.1.2600.2.Service Pack 3

Raw data

00,FF,FF,FF,FF,FF,FF,FF,00,2D,B2,0B,04,A0,42,00,00,30,15,01,03,00,46,27,78,0B,D5,7C,A3,57,49,9C,25,11,48,4B,FF,FF,80,31,40,45,40,61,40,71,4F,81,8F,81,40,81,80,8B,C0,D6,09,80,A0,20,E0,2D,10,10,60,A2,00,04,03,00,00,00,18,02,3A,80,18,71,38,2D,40,58,2C,45,00,10,09,00,00,00,1E,00,00,00,FC,00,56,47,41,2D,49,4E,32,2D,46,31,36,0A,20,48,3F,40,30,62,B0,32,40,40,C0,13,00,6F,13,11,00,00,1E,00,A8

Hardware data

BUS_SLOT = PCI0000.PCI00004.PCI00008.PCI0000C.PCI00010.PCI00014.PCI00018.PCI0001C
 00000000 = 2E208086.20900006.06000003.00000000.00000000.00000000.00000000.00000000
 00000008 = 2E218086.00100007.06040003.00010010.00000000.00000000.00010100.2000E0E0
 00000018 = 2E248086.00100006.07800003.00800000.D0325904.00000000.00000000.00000000
 000000C8 = 10CE8086.00100007.02000000.00000000.D0300000.D0324000.0000F0C1.00000000
 000000D0 = 3A378086.02900005.0C030000.00800000.00000000.00000000.00000000.00000000
 000000D8 = 3A3E8086.00100006.04030000.00000010.D0320004.00000000.00000000.00000000
 000000E0 = 3A408086.00100007.06040000.00810010.00000000.00000000.00020200.2000D0D0
 000000E8 = 3A348086.02900005.0C030000.00800000.00000000.00000000.00000000.00000000
 000000E9 = 3A358086.02900005.0C030000.00000000.00000000.00000000.00000000.00000000
 000000EA = 3A368086.02900005.0C030000.00000000.00000000.00000000.00000000.00000000
 000000EF = 3A3A8086.02900006.0C032000.00000000.D0325000.00000000.00000000.00000000
 000000F0 = 244E8086.00100007.06040190.00010000.00000000.00000000.20040400.228000F0
 000000F8 = 3A188086.02100007.06010000.00800000.00000000.00000000.00000000.00000000
 00000100 = 68191002.00100007.03000000.00800010.C000000C.00000000.D0000004.00000000

```

00000101 = AAB01002.00100007.04030000.00800010.D0060004.00000000.00000000.00000000
00000200 = C1401415.00100000.07000200.00800010.0000D011.00000000.00000000.00000000
00000201 = C1411415.00100000.07000200.00800010.0000D001.00000000.00000000.00000000
00000300 = 2368197B.00100007.01018500.00000010.0000C041.0000C031.0000C021.0000C011
00000430 = 581111C1.02900006.0C001070.00002010.D0100000.00000000.00000000.00000000
-----
01050000 = 00FFFFFF.FFFFFFF0.10AC1340.51364642.12100103.80221B78.EEC5C6A3.574A9C23
00000020 = 124F54A5.4B00714F.81800101.01010101.01010101.0101302A.00985100.2A403070
00000040 = 1300520E.1100001E.000000FF.00434332.38323635.35424636.510A0000.00FC0044
00000060 = 454C4C20.31373037.46500A20.000000FD.00384C1E.510E000A.20202020.20200042
01060000 = 00FFFFFF.FFFFFFF0.2DB20B04.A0420000.30150103.00462778.0BD57CA3.57499C25
00000020 = 11484BFF.FF803140.45406140.714F818F.81408180.8BC0D609.80A020E0.2D101060
00000040 = A2000403.00000018.023A8018.71382D40.582C4500.10090000.001E0000.00FC0056
00000060 = 47412D49.4E322D46.31360A20.483F4030.62B03240.40C01300.6F131100.001E00A8

```

VGAA-IN2-F16 / VGAA-OUT2-F16

Monitor Asset Manager Report, generated 11/25/2014
Copyright (c) 1995-2013, EnTech Taiwan.

Monitor #1 [Real-time 0x0011]

Model name..... VGA+A-IN2-F16
Manufacturer..... KMR
Plug and Play ID..... KMR0530
Serial number..... 24992
Manufacture date..... 2013, ISO week 46
Filter driver..... None

EDID revision..... 1.3
Input signal type..... Analog 0.700,0.300 (1.0V p-p)
Sync input support..... Not available
Display type..... RGB color
Screen size..... 700 x 390 mm (31.5 in)
Power management..... Not supported
Extension blocs..... None

DDC/CI..... Not supported

Color characteristics

Default color space..... Non-sRGB
Display gamma..... 2.20
Red chromaticity..... Rx 0.640 - Ry 0.341
Green chromaticity..... Gx 0.286 - Gy 0.610
Blue chromaticity..... Bx 0.146 - By 0.069
White point (default).... Wx 0.284 - Wy 0.293
Additional descriptors... None

Timing characteristics

Range limits..... Not available
GTF standard..... Supported
Additional descriptors... None
Preferred timing..... Yes
Native/preferred timing.. 640x480p at 60Hz (4:3)
Modeline..... "640x480" 25.180 640 656 752 800 480 490 492 525 -hsync -vsync
Detailed timing #1..... 1920x1080p at 60Hz (16:9)
Modeline..... "1920x1080" 148.500 1920 2008 2052 2200 1080 1084 1089 1125 +hsync +vsync
Detailed timing #2..... 1600x1200p at 60Hz (4:3)
Modeline..... "1600x1200" 162.000 1600 1664 1856 2160 1200 1201 1204 1250 +hsync +vsync

Standard timings supported

720 x 400p at 70Hz - IBM VGA
720 x 400p at 88Hz - IBM XGA2
640 x 480p at 60Hz - IBM VGA
640 x 480p at 67Hz - Apple Mac II
640 x 480p at 72Hz - VESA
640 x 480p at 75Hz - VESA
800 x 600p at 56Hz - VESA
800 x 600p at 60Hz - VESA
800 x 600p at 72Hz - VESA
800 x 600p at 75Hz - VESA
832 x 624p at 75Hz - Apple Mac II
1024 x 768i at 87Hz - IBM
1024 x 768p at 60Hz - VESA
1024 x 768p at 70Hz - VESA
1024 x 768p at 75Hz - VESA
1280 x 1024p at 75Hz - VESA
1152 x 870p at 75Hz - Apple Mac II
640 x 480p at 60Hz - VESA STD
800 x 600p at 60Hz - VESA STD
1024 x 768p at 60Hz - VESA STD
1152 x 864p at 75Hz - VESA STD
1280 x 1024p at 75Hz - VESA STD
1280 x 960p at 60Hz - VESA STD
1280 x 1024p at 60Hz - VESA STD
1360 x 765p at 60Hz - VESA STD

Report information

Date generated..... 11/25/2014
Software revision..... 2.70.0.989
Data source..... Real-time 0x0011
Operating system..... 6.1.7601.2.Service Pack 1

Raw data

```

00,FF,FF,FF,FF,FF,00,2D,B2,30,05,A0,61,00,00,2E,17,01,03,00,46,27,78,0B,D5,7C,A3,57,49,9C,25,
11,48,4B,FF,FF,80,31,40,45,40,61,40,71,4F,81,8F,81,40,81,80,8B,C0,D6,09,80,A0,20,E0,2D,10,10,60,
A2,00,04,03,00,00,00,18,02,3A,80,18,71,38,2D,40,58,2C,45,00,10,09,00,00,00,1E,00,00,00,FC,00,56,
47,41,2B,41,2D,49,4E,32,2D,46,31,36,48,3F,40,30,62,B0,32,40,40,C0,13,00,6F,13,11,00,00,1E,00,21

```

Hardware data

```

BUS_SLOT = PCI0000.PCI0004.PCI0008.PCI000C.PCI0010.PCI0014.PCI0018.PCI001C
00000000 = 01048086.20900006.06000009.00000000.00000000.00000000.00000000.00000000
00000008 = 01018086.00100007.06040009.00810010.00000000.00000000.00010100.20004040
00000010 = 01268086.00900407.03000009.00000000.E5400004.00000000.C000000C.00000000
000000B0 = 1C3A8086.00100006.07800004.00800000.E6EB0004.00000000.00000000.00000000
000000B3 = 1C3D8086.00B00400.07000204.00000000.000050E1.E6E90000.00000000.00000000
000000C8 = 15028086.00100406.02000004.00000000.E6E00000.E6E80000.00000001.00000000
000000D0 = 1C2D8086.02900006.0C032004.00000000.E6E70000.00000000.00000000.00000000
000000D8 = 1C208086.00100006.04030004.00000010.E6E60004.00000000.00000000.00000000
000000E0 = 1C108086.00100004.060400B4.00810010.00000000.00000000.00020200.200000F0

```

```

000000E8 = 1C268086.02900006.0C032004.00000000.E6E50000.00000000.00000000.00000000
000000F8 = 1C4F8086.02100007.06010004.00800000.00000000.00000000.00000000.00000000
000000FA = 282A8086.02B00007.01040004.00000000.000050D1.000050C1.000050B1.000050A1
000000FB = 1C228086.02800003.0C050004.00000000.E6E30004.00000000.00000000.00000000
00000300 = 00828086.00100406.02800034.00000010.E6D00004.00000000.00000000.00000000
00000B00 = 13F71217.00100006.0C001005.00800010.E6C30000.00000000.00000000.00000000
00000B01 = 83211217.00100006.08050105.00800010.E6C20000.00000000.00000000.00000000
00000B02 = 83311217.00100006.01800005.00800010.E6C10000.00000000.E6C00000.00000000
-----
01010000 = 00FFFFFF.FFFFFFF0.2DB23005.A0610000.2E170103.00462778.0BD57CA3.57499C25
00000020 = 11484BFF.FF803140.45406140.714F818F.81408180.8BC0D609.80A020E0.2D101060
00000040 = A2000403.00000018.023A8018.71382D40.582C4500.10090000.001E0000.00FC0056
00000060 = 47412B41.2D494E32.2D463136.483F4030.62B03240.40C01300.6F131100.001E0021

```

AAD-IN2-F16 / AAD-OUT2-F16

```

Monitor
Model name..... VS-16AAD
Manufacturer..... KMR
Plug and Play ID..... KMR0200
Serial number..... 1
Manufacture date..... 2014, ISO week 19
Filter driver..... None
-----
EDID revision..... 1.3
Input signal type..... Digital (HDMI-a)
Color bit depth..... Undefined
Display type..... RGB color
Screen size..... 700 x 390 mm (31.5 in)
Power management..... Not supported
Extension blocs..... 1 (CEA-EXT)
-----
DDC/CI..... Not supported
Color characteristics
Default color space..... Non-sRGB
Display gamma..... 2.20
Red chromaticity..... Rx 0.640 - Ry 0.341
Green chromaticity..... Gx 0.286 - Gy 0.610
Blue chromaticity..... Bx 0.146 - By 0.069
White point (default)... Wx 0.284 - Wy 0.293
Additional descriptors... None
Timing characteristics
Horizontal scan range.... 31-94kHz
Vertical scan range..... 50-85Hz
Video bandwidth..... 170MHz
CVT standard..... Not supported
GTF standard..... Not supported
Additional descriptors... None
Preferred timing..... Yes
Native/preferred timing.. 1280x720p at 60Hz
  Modeline..... "1280x720" 74.250 1280 1390 1430 1650 720 725 730 750 +hsync +vsync
Detailed timing #1..... 1920x1080p at 60Hz (16:9)
  Modeline..... "1920x1080" 148.500 1920 2008 2052 2200 1080 1084 1089 1125 +hsync +vsync
Standard timings supported
  720 x 400p at 70Hz - IBM VGA
  720 x 400p at 88Hz - IBM XGA2
  640 x 480p at 60Hz - IBM VGA
  640 x 480p at 67Hz - Apple Mac II
  640 x 480p at 72Hz - VESA
  640 x 480p at 75Hz - VESA
  800 x 600p at 56Hz - VESA
  800 x 600p at 60Hz - VESA
  800 x 600p at 72Hz - VESA
  800 x 600p at 75Hz - VESA
  832 x 624p at 75Hz - Apple Mac II
  1024 x 768i at 87Hz - IBM
  1024 x 768p at 60Hz - VESA
  1024 x 768p at 70Hz - VESA
  1024 x 768p at 75Hz - VESA
  1280 x 1024p at 75Hz - VESA
  1152 x 870p at 75Hz - Apple Mac II
  1280 x 720p at 60Hz - VESA STD
  1280 x 800p at 60Hz - VESA STD
  1440 x 900p at 60Hz - VESA STD
  1280 x 960p at 60Hz - VESA STD
  1280 x 1024p at 60Hz - VESA STD
  1400 x 1050p at 60Hz - VESA STD
  1680 x 1050p at 60Hz - VESA STD
  1600 x 1200p at 60Hz - VESA STD
EIA/CEA-861 Information
Revision number..... 3
IT underscan..... Not supported
Basic audio..... Supported
YCbCr 4:4:4..... Not supported
YCbCr 4:2:2..... Not supported
Native formats..... 1
Detailed timing #1..... 720x480p at 60Hz (4:3)
  Modeline..... "720x480" 27.000 720 736 798 858 480 489 495 525 -hsync -vsync
Detailed timing #2..... 1920x1080i at 60Hz (16:9)
  Modeline..... "1920x1080i" 74.250 1920 2008 2052 2200 1080 1084 1094 1124 interface +hsync +vsync
Detailed timing #3..... 1920x1080i at 50Hz (16:9)
  Modeline..... "1920x1080i" 74.250 1920 2448 2492 2640 1080 1084 1094 1124 interface +hsync +vsync
Detailed timing #4..... 1280x720p at 60Hz (16:9)
  Modeline..... "1280x720" 74.250 1280 1390 1430 1650 720 725 730 750 +hsync +vsync
Detailed timing #5..... 1280x720p at 50Hz (16:9)
  Modeline..... "1280x720" 74.250 1280 1720 1760 1980 720 725 730 750 +hsync +vsync
CE video identifiers (VICs) - timing/formats supported
  720 x 576p at 50Hz - EDTV (4:3, 16:15)
  1280 x 720p at 50Hz - HDTV (16:9, 1:1)
  1920 x 1080i at 60Hz - HDTV (16:9, 1:1)
  1920 x 1080i at 50Hz - HDTV (16:9, 1:1)
  1280 x 720p at 60Hz - HDTV (16:9, 1:1) [Native]
  1920 x 1080p at 60Hz - HDTV (16:9, 1:1)
  1920 x 1080p at 50Hz - HDTV (16:9, 1:1)

```

NB: NTSC refresh rate = (Hz*1000)/1001
CE audio data (formats supported)
LPCM 2-channel, 16/20/24 bit depths at 44/48 kHz
CE speaker allocation data
Channel configuration.... 2.0
Front left/right..... Yes
Front LFE..... No
Front center..... No
Rear left/right..... No
Rear center..... No
Front left/right center.. No
Rear left/right center... No
Rear LFE..... No
CE vendor specific data (VSDB)
IEEE registration number. 0x000C03
CEC physical address..... 1.0.0.0
Maximum TMDS clock..... 165MHz
Report information
Date generated..... 24/08/2015
Software revision..... 2.70.0.989
Data source..... Real-time 0x0071
Operating system..... 6.1.7601.2.Service Pack 1
Raw data
00,FF,FF,FF,FF,FF,FF,00,2D,B2,00,02,01,00,00,00,13,18,01,03,82,46,27,78,0A,D5,7C,A3,57,49,9C,25,
11,48,4B,FF,FF,80,81,C0,81,00,95,00,81,40,81,80,90,40,B3,00,A9,40,01,1D,00,72,51,D0,1E,20,6E,28,
55,00,7E,88,42,00,00,1E,02,3A,80,18,71,38,2D,40,58,2C,45,00,C4,8E,21,00,00,1E,00,00,00,FC,00,56,
53,2D,31,36,41,41,44,0A,20,20,20,20,00,00,00,FD,00,32,55,1F,5E,11,00,0A,20,20,20,20,20,01,9E,
02,03,1A,41,47,11,13,05,14,84,10,1F,23,09,06,07,83,01,00,00,65,03,0C,00,10,00,8C,0A,D0,8A,20,E0,
2D,10,10,3E,96,00,58,C2,21,00,00,18,01,1D,80,18,71,1C,16,20,58,2C,25,00,C4,8E,21,00,00,9E,01,1D,
80,D0,72,1C,16,20,10,2C,25,80,C4,8E,21,00,00,9E,01,1D,00,72,51,D0,1E,20,6E,28,55,00,C4,8E,21,00,
00,1E,01,1D,00,BC,52,D0,1E,20,B8,28,55,40,C4,8E,21,00,00,1E,00,00,00,00,00,00,00,00,00,00,C2

UHDS-OUT2-F16

Model name UHDS-OUT2-F16
Manufacturer KMR
Plug and Play ID KMR0672
Data string Default-EDID
Serial number n/a
Manufacture date 2020, ISO week 255
Filter driver None

EDID revision 1.3
Input signal type Digital
Color bit depth Undefined
Display type RGB color
Screen size 520 x 320 mm (24.0 in)
Power management Standby, Suspend, Active off/sleep
Extension blocs 1 (CEA-EXT)

DDC/CI n/a

Color characteristics
Default color space Non-sRGB
Display gamma 2.20
Red chromaticity..... Rx 0.674 - Ry 0.319 Green chromaticity..... Gx 0.188 - Gy 0.706 Blue chromaticity..... Bx 0.148 - By 0.064 White point (default).... Wx 0.313 -
Wy 0.329 Additional descriptors None

Timing characteristics
Horizontal scan range.... 30-83kHz Vertical scan range .. 56-76Hz
Video bandwidth 170MHz
CVT standard Not supported
GTF standard Not supported
Additional descriptors Established timings
Preferred timing Yes
Native/preferred timing.. 1920x1080p at 60Hz (16:9)
Modeline "1920x1080" 148.500 1920 2008 2052 2200 1080 1084 1089 1125 +hsync +vsync

Standard timings supported
640 x 480p at 60Hz - IBM VGA
640 x 480p at 72Hz - VESA
640 x 480p at 75Hz - VESA
800 x 600p at 60Hz - VESA
800 x 600p at 72Hz - VESA
800 x 600p at 75Hz - VESA
1024 x 768p at 60Hz - VESA
1024 x 768p at 70Hz - VESA
1024 x 768p at 75Hz - VESA
1280 x 1024p at 75Hz - VESA
1600 x 900p at 60Hz - VESA STD
1280 x 800p at 60Hz - VESA STD
1600 x 1200p at 60Hz - VESA STD
1024 x 768p at 85Hz - VESA STD
800 x 600p at 85Hz - VESA STD
640 x 480p at 85Hz - VESA STD
1152 x 864p at 75Hz - VESA STD
1280 x 960p at 60Hz - VESA STD

848 x 480p at 60Hz - VESA
1280 x 768p at 60Hz - VESA
1280 x 1024p at 60Hz - VESA
1360 x 768p at 60Hz - VESA
1440 x 900p at 60Hz - VESA
1400 x 1050p at 60Hz - VESA
1650 x 1050p at 60Hz - VESA
EIA/CEA-861 Information Revision number 3
IT underscan Supported
Basic audio Supported
YCbCr 4:4:4 Supported
YCbCr 4:2:2 Supported

Native formats 1
 Detailed timing #1 1920x1080p at 60Hz (16:9)
 Modeline "1920x1080" 148.500 1920 2008 2052 2200 1080 1084 1089 1125 +hsync +vsync
 Detailed timing #2 1920x1080i at 60Hz (16:9)
 Modeline "1920x1080" 74.250 1920 2008 2052 2200 1080 1084 1094 1124 interlace +hsync +vsync
 Detailed timing #3 1280x720p at 60Hz (16:9)
 Modeline "1280x720" 74.250 1280 1390 1430 1650 720 725 730 750 +hsync +vsync
 Detailed timing #4 720x480p at 60Hz (16:9)
 Modeline "720x480" 27.000 720 736 798 858 480 489 495 525 -hsync -vsync

CE video identifiers (VICs) - timing/formats supported 1920 x 1080p at 60Hz - HDTV (16:9, 1:1) [Native]
 1920 x 1080i at 60Hz - HDTV (16:9, 1:1)
 720 x 480p at 60Hz - EDTV (4:3, 8:9)
 1920 x 1080i at 50Hz - HDTV (16:9, 1:1)
 1920 x 1080p at 50Hz - HDTV (16:9, 1:1)
 1920 x 1080p at 24Hz - HDTV (16:9, 1:1)
 1920 x 1080p at 30Hz - HDTV (16:9, 1:1)
 1920 x 1080p at 30Hz - HDTV (16:9, 1:1)
 1920 x 1080p at 30Hz - HDTV (16:9, 1:1)
 1920 x 1080p at 30Hz - HDTV (16:9, 1:1)
 1920 x 1080p at 30Hz - HDTV (16:9, 1:1)
 1920 x 1080p at 30Hz - HDTV (16:9, 1:1)
 1920 x 1080p at 30Hz - HDTV (16:9, 1:1)
 1920 x 1080p at 30Hz - HDTV (16:9, 1:1)
 1920 x 1080p at 30Hz - HDTV (16:9, 1:1)
 1920 x 1080p at 30Hz - HDTV (16:9, 1:1)
 1920 x 1080p at 30Hz - HDTV (16:9, 1:1)
 1920 x 1080p at 30Hz - HDTV (16:9, 1:1) NB: NTSC refresh rate = (Hz*1000)/1001

CE audio data (formats supported)
 LPCM 2-channel, 16/20/24 bit depths at 32/44/48 kHz

CE vendor specific data (VSDB)
 IEEE registration number. 0x000C03 CEC physical address 1.0.0.0
 Maximum TMDS clock 165MHz

CE speaker allocation data Channel configuration 2.0
 Front left/right Yes
 Front LFE No
 Front center No
 Rear left/right No
 Rear center No
 Front left/right center.. No Rear left/right center No
 Rear LFE No

Report information
 Date generated 29/01/2019
 Software revision 2.60.0.972
 Data source..... Real-time 0x0032
 Operating system..... 6.1.7601 2.Service Pack 1

Protocol 3000

The **VS-1616DN-EM 2x2 to 16x16 Modular Multi-Format Managed Digital Matrix Switcher** can be operated using the Kramer Protocol 3000 serial commands. The command framing varies according to how you interface with the **VS-1616DN-EM**. For example, a basic video input switching command that routes a layer 1 video signal to HDBT out 1 from HDMI input 2 (`ROUTE 1, 1, 2`), is entered as follows:

- Terminal communication software, such as Hercules:

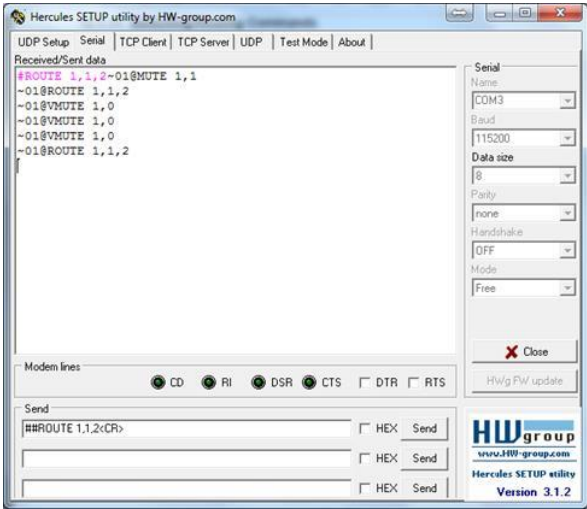

i The framing of the command varies according to the terminal communication software.

- K-Touch Builder (Kramer software):

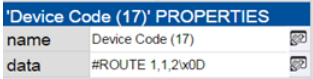

- K-Config (Kramer configuration software):

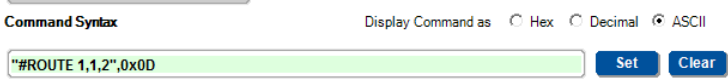

i All the examples provided in this section are based on using the K-Config software.

You can enter commands directly using terminal communication software (e.g., Hercules) by connecting a PC to the serial or Ethernet port on the **VS-1616DN-EM**. To enter CR press the Enter key (LF is also sent but is ignored by the command parser).

Commands sent from various non-Kramer controllers (e.g., Crestron) may require special coding for some characters (such as, `/X##`). For more information, refer to your controller's documentation.

For more information about:

- Understanding Protocol 3000 commands (see [Understanding Protocol 3000](#) on page [123](#)).
- General syntax used for Protocol 3000 commands (see [Protocol 3000 Syntax](#) on page [124](#)).
- Protocol 3000 commands available for the VS-1616DN-EM (see [Protocol 3000 Commands](#) on page [124](#)).
- Using the packet protocol (see [Using the Packet Protocol](#) on page [151](#))

Understanding Protocol 3000 Commands

Protocol 3000 commands are structured according to the following:

- **Command** – A sequence of ASCII letters (A-Z, a-z and -). A command and its parameters must be separated by at least one space.
- **Parameters** – A sequence of alphanumeric ASCII characters (0-9, A-Z, a-z and some special characters for specific commands). Parameters are separated by commas.
- **Message string** – Every command entered as part of a message string begins with a message starting character and ends with a message closing character.



A string can contain more than one command. Commands are separated by a pipe (|) character. The maximum string length is 64 characters.

- **Message starting character:**
 - # – For host command/query.
 - ~ – For device response.
- **Device address** – K-NET Device ID followed by @ (optional, K-NET only).
- **Query sign** – ? follows some commands to define a query request.
- **Message closing character:**
 - CR – Carriage return for host messages (ASCII 13).
 - CR LF – Carriage return for device messages (ASCII 13) and line-feed (ASCII 10).
- **Command chain separator character** – Multiple commands can be chained in the same string. Each command is delimited by a pipe character (|). When chaining commands, enter the message starting character and the message closing character only at the beginning and end of the string.



Spaces between parameters or command terms are ignored. Commands in the string do not execute until the closing character is entered. A separate response is sent for every command in the chain.

Protocol 3000 Syntax

The Kramer Protocol 3000 syntax uses the following delimiters:

- **CR** = Carriage return (ASCII 13 = 0x0D).
- **LF** = Line feed (ASCII 10 = 0x0A).
- **SP** = Space (ASCII 32 = 0x20).

Some commands have short name syntax in addition to long name syntax to enable faster typing. The response is always in long syntax.

The Protocol 3000 syntax is in the following format:

- **Host Message Format:**

Start	Address (optional)	Body	Delimiter
#	<i>device_id@</i>	Message	CR

- **Simple Command** – Command string with only one command without addressing:

Start	Address (optional)	Body	Delimiter
#	<i>device_id@</i>	Message	CR

- **Command String** – Formal syntax with commands concatenation and addressing:

Start	Body	Delimiter
#	Command SP <i>Parameter_1,Parameter_2,...</i>	CR

- **Device Message Format:**

Start	Address (optional)	Body	Delimiter
~	<i>device_id@</i>	Message	CR LF

- **Device Long Response** – Echoing command:

Start	Address (optional)	Body	Delimiter
~	<i>device_id@</i>	Command SP <i>[Param1,Param2,...]</i> result	CR LF

Protocol 3000 Commands

This section includes the following commands:

- System Mandatory Commands (see [System Mandatory Commands](#) on page [125](#)).
- System Commands (see [System Commands](#) on page [131](#)).
- Routing Commands (see [Routing Commands](#) on page [137](#)).
- Video Commands (see [Video Commands](#) on page [143](#)).
- Audio Commands (see [Audio Commands](#) on page [147](#)).

System Mandatory Commands

Command	Description
#	Protocol handshaking
BUILD-DATE	Read device build date
FACTORY	Reset to factory default configuration
HELP	List of commands
MODEL	Read device model
PROT-VER	Read device protocol version
RESET	Reset device
SN	Read device serial number
VERSION	Read device firmware version



Not every command listed by the `HELP` command is relevant to every matrix configuration.

#

Functions		Permission	Transparency
Set	#	End User	Public
Get	-	-	-
Description		Syntax	
Set	Protocol handshaking	# <code>CR</code>	
Get	-	-	
Response			
~nn@SP <code>OK</code> CR LF			
Parameters			
Response Trigger			
Notes			
Validates the Protocol 3000 connection and gets the machine number			
K-Config Example			
`#`, 0x0D			

BUILD-DATE

Functions		Permission	Transparency
Set	-	-	-
Get	BUILD-DATE?	End User	Public
Description		Syntax	
Set	-	-	
Get	Get device build date	# BUILD-DATE <code>CR</code>	
Response			
~ <code>nn</code> @ BUILD-DATE <code>SP</code> <i>date</i> <code>SP</code> <i>time</i> <code>CR LF</code>			
Parameters			
<i>date</i> – Format: YYYY/MM/DD where YYYY = Year, MM = Month, DD = Day			
<i>time</i> – Format: hh:mm:ss where hh = hours, mm = minutes, ss = seconds			
Response Trigger			
Notes			
K-Config Example			
`#BUILD-DATE?`, 0x0D			

FACTORY

Functions		Permission	Transparency
Set	FACTORY	End User	Public
Get	-	-	-
Description		Syntax	
Set	Reset device to factory default configuration	# FACTORY <input type="text"/>	
Get	-	-	
Response			
~ <input type="text"/> <input type="text"/> @ FACTORY <input type="text"/> SP OK <input type="text"/> CR LF			
Parameters			
Response Trigger			
Notes			
This command deletes all user data from the device. The deletion can take some time.			
K-Config Example			
`#FACTORY?`, 0x0D			

HELP

Functions		Permission	Transparency
Set	-	-	-
Get	HELP	End User	Public
Description		Syntax	
Set	-	-	
Get	Get command list or help for specific command	# HELP <input type="text"/>	
Response			
Multi-line: ~ <input type="text"/> <input type="text"/> @Device available protocol 3000 commands: <input type="text"/> CR LF <i>command</i> , <input type="text"/> SP <i>command</i> .. <input type="text"/> CR LF			
Parameters			
Response Trigger			
Notes			
K-Config Example			
`#HELP`, 0x0D			

MODEL

Functions		Permission	Transparency
Set	-	-	-
Get	MODEL?	End User	Public
Description		Syntax	
Set	-	-	
Get	Get device model	# MODEL? <code>CR</code>	
Response			
~ <code>nn</code> @ MODEL <code>SP</code> <i>model_name</i> <code>CR LF</code>			
Parameters			
<i>model_name</i> - String of up to 16 printable ASCII chars			
Response Trigger			
Notes			
K-Config Example			
`#MODEL?`, 0x0D			

PROT-VER

Functions		Permission	Transparency
Set	-	-	-
Get	PROT-VER?	End User	Public
Description		Syntax	
Set	-	-	
Get	Get device protocol version	# PROT-VER? <code>CR</code>	
Response			
~ <code>nn</code> @ PROT-VER <code>SP</code> 3000: <i>version</i> <code>CR LF</code>			
Parameters			
<i>Version</i> - XX.XX where X is a decimal digit			
Response Trigger			
Notes			
K-Config Example			
`#PROT-VER?`, 0x0D			

RESET

Functions		Permission	Transparency
Set	RESET	Administrator	Public
Get	-	-	-
Description		Syntax	
Set	Reset device	# RESET <input type="text"/>	
Get	-	-	
Response			
~ <input type="text"/> <input type="text"/> @RESET <input type="text"/> SP <input type="text"/> OK <input type="text"/> CR LF			
Parameters			
Response Trigger			
Notes			
To avoid locking the port due to a USB bug in Windows, disconnect USB connections immediately after running this command. If the port was locked, disconnect and reconnect the cable to reopen the port.			
K-Config Example			
`"#RESET",0x0D`			

SN

Functions		Permission	Transparency
Set	-	-	-
Get	SN?	End User	Public
Description		Syntax	
Set	-	-	
Get	Get device serial number	# SN? <input type="text"/>	
Response			
~ <input type="text"/> <input type="text"/> @SN <input type="text"/> SP <i>serial_number</i> <input type="text"/> CR LF			
Parameters			
<i>serial_number</i> – 11 decimal digits, factory assigned			
Response Trigger			
Notes			
For new products with 14 digit serial numbers, use only the last 11 digits			
K-Config Example			
`"#sn?",0x0D`			

VERSION

Functions		Permission	Transparency
Set	-	-	-
Get	VERSION?	End User	Public
Description		Syntax	
Set	-	-	
Get	Get firmware version number	# VERSION? <code>CR</code>	
Response			
~ <code>nn</code> @ VERSION <code>SP</code> <i>firmware_version</i> <code>CR LF</code>			
Parameters			
<i>firmware_version</i> – XX.XX.XXXX where the digit groups are: major.minor.build version			
Response Trigger			
Notes			
K-Config Example			
`#VERSION?`, 0x0D			

System Commands

Command	Description
CPEDID	Copy EDID data from the output to the input EEPROM
GEDID	Read EDID data
GEDID-EXT	Read EDID data from external device connected to output
HDCP-MOD	Set/Get HDCP mode
HDCP-STAT	Get HDCP signal status
LDEDID	Load EDID data
LOCK-FP	Lock front panel
MODULE-INFO	Get module information
MODULE-TYPE	Set/Get module type, slot location, and status
MODULE-VER	Read module firmware version

CPEDID

Functions		Permission	Transparency
Set	CPEDID	End User	Public
Get	-	-	-
Description		Syntax	
Set	Copy EDID data from the output to the input EEPROM	#CPEDID <input type="text" value="SP"/> <i>output_id</i> , <i>input_id</i> <input type="text" value="CR"/>	
Get	-	-	
Response			
~ <input type="text" value="nn"/> @CPEDID <input type="text" value="SP"/> <i>output_id</i> , <i>input_id</i> <input type="text" value="CR LF"/>			
Parameters			
<i>output_id</i> – video output ID: 1-16 (varies according to installed output cards, see Port Numbering on page 12)			
<i>input_id</i> – video input ID: 1-16 (varies according to installed input cards, see Port Numbering on page 12)			
Response Trigger			
Response is sent to the com port from which the Set was received (before execution)			
Notes			
K-Config Example			
Copy the EDID data from output 8 to input 1: `#CPEDID 8,1,0x1",0x0D`			

GEDID

Functions		Permission	Transparency
Set	GEDID	End User	Public
Get	-	-	-
Description		Syntax	
Set	Read EDID data from device	# GEDID [SP] <i>eeeprom_id</i> [CR]	
Get	-	-	
Response			
Multi-line response: ~ nn @ GEDID [SP] <i>eeeprom_id,size</i> [CR LF] <i>Edid_data</i> [CR LF] ~ nn @ GEDID [SP] <i>eeeprom_id</i> [SP] OK [CR LF]			
Parameters			
<i>eeeprom_id</i> – Input port EEPROM ID from which to get the EDID: 1-16 (varies according to installed input cards, see Port Numbering on page 12) <i>size</i> – EDID data size sent from the device <i>Edid_data</i> – EDID data, as byte stream			
Response Trigger			
Response is sent to the com port from which the Set (before execution) command was received			
Notes			
K-Config Example			
Read EDID data from a device connected to Input 1: `#GEDID 1",0x0D			

GEDID-EXT

Functions		Permission	Transparency
Set	GEDID-EXT	End User	Public
Get	-	-	-
Description		Syntax	
Set	Read EDID data from external device connected to an output	# GEDID [SP] <i>out_id</i> [CR]	
Get	-	-	
Response			
Multi-line response: ~ nn @ GEDID-EXT [SP] <i>out_id,size</i> [CR LF] <i>EDID_data</i> [CR LF] ~ nn @ GEDID-EXT [SP] <i>out_id</i> [SP] OK [CR LF]			
Parameters			
<i>out_id</i> – Output port EEPROM ID from which to get the EDID: 1-16 (varies according to installed output cards, see Port Numbering on page 12) <i>size</i> – EDID data size sent from the device <i>Edid_data</i> – EDID data, as byte stream)			
Response Trigger			
Response is sent to the com port from which the Set (before execution) command was received			
Notes			
K-Config Example			
Read EDID data from a device connected to Output 5: `#GEDID-EXT 5",0x0D			

HDCP-MOD

Functions		Permission	Transparency
Set	HDCP-MOD	Administrator	Public
Get	HDCP-MOD?	End User	Public
Description		Syntax	
Set	Set HDCP mode	#HDCP-MOD[SP]inp_id,mode[CR]	
Get	Get HDCP mode	#HDCP-MOD?[SP]inp_id[CR]	
Response			
Set / Get: ~[nn]@HDCP-MOD[SP]inp_id,mode[CR LF]			
Parameters			
inp_id – input number: 1-16 (varies according to installed input cards, see Port Numbering on page 12)			
mode – HDCP mode: 0 (HDCP Off), 1 (HDCP On), 2 (Follow input), 3 (Mirror output – MAC mode)			
Response Trigger			
A response is sent to the com port from which the set (before execution) / get command was received A response is sent to all com ports after command execution if HDCP-MOD was set by any other external control device (device button, device menu or other) or if the HDCP mode changed			
Notes			
Set HDCP working mode on the device input: HDCP not supported - HDCP Off HDCP support changes following detected sink - MIRROR OUTPUT			
K-Config Example			
Disable HDCP mode on input 3: `#HDCP-MOD 3,0",0x0D			

HDCP-STAT

Functions		Permission	Transparency
Set	-	-	-
Get	HDCP-STAT?	End User	Public
Description		Syntax	
Set	-	-	
Get	Get HDCP signal status	#HDCP-STAT?[SP]stage,stage_id[CR]	
Response			
~[nn]@HDCP-STAT[SP]stage,stage_id,status[CR LF]			
Parameters			
stage – 0 (input), 1 (output)			
stage_id – input/output number: 1-16 (varies according to installed input/output cards, see Port Numbering on page 12)			
status – signal encryption status: 0 (HDCP Off), 1 (HDCP On), 2 (Follow input), 3 (Mirror output – MAC mode)			
Response Trigger			
Response is sent to the com port from which the Get command was received			
Notes			
Output stage (1) – get the HDCP signal status of the sink device connected to the specified output Input stage (0) – get the HDCP signal status of the source device connected to the specified input			
K-Config Example			
Get the HDCP input signal status of the source device connected to input 9: `#HDCP-STAT? 0,9",0x0D			

LDEDID

Functions		Permission	Transparency
Set	LDEDID	End User	Public
Get	-	-	-
Description		Syntax	
Set	Write EDID data from external application to device	Multi-step syntax (see following steps)	
Get	-	-	
Response			
Step 1: # LDEDID [SP] <i>EEPROM_ID,size</i> [CR]			
Response 1: ~ <i>nn</i> @ LDEDID [SP] <i>EEPROM_ID,size</i> [SP] READY [CR LF] or ~ <i>nn</i> @ LDEDID [SP] ERR <i>nn</i> [CR LF]			
Step 2: If READY was received, send EDID DATA			
Response 2: ~ <i>nn</i> @ LDEDID [SP] <i>EEPROM_ID,size</i> [SP] OK [CR LF]			
Parameters			
<i>EEPROM_ID</i> – Input port EEPROM destination for the EDID data: 1-16 (varies according to installed input cards, see Port Numbering on page 12)			
<i>size</i> – EDID data size			
EDID DATA – HEX or KFW file in protocol packets (see Using the Packet Protocol on page 151)			
Response Trigger			
Response is sent to the com port from which the Set (before execution) command was received			
Notes			
When the unit receives the LDEDID command it replies with READY and enters the special EDID packet wait mode. In this mode the unit can receive only packets and not regular protocol commands. If the unit does not receive correct packets for 30 seconds or is interrupted for more than 30 seconds before receiving all packets, it sends timeout error ~ <i>nn</i> @ LDEDID [SP] ERR01 [CR LF] and returns to the regular protocol mode. If the unit received data that is not a correct packet, it sends the corresponding error and returns to the regular protocol mode.			
K-Config Example			
Write EDID data from external application to Input 1: `#LDEDID 1,256",0x0D`			

LOCK-FP

Functions		Permission	Transparency
Set	LOCK-FP	End User	Public
Get	LOCK-FP?	End User	Public
Description		Syntax	
Set	Lock front panel	# LOCK-FP [SP] <i>lock_mode</i> [CR]	
Get	Get front panel lock state	# LOCK-FP? [CR]	
Response			
Set: ~ <i>nn</i> @ LOCK-FP [SP] <i>lock_mode</i> [SP] OK [CR LF]			
Get: ~ <i>nn</i> @ LOCK-FP [SP] <i>lock_mode</i> [CR LF]			
Parameters			
<i>lock_mode</i> – 0/OFF (unlocks the front panel buttons), 1/ON (locks the front panel buttons)			
Response Trigger			
Notes			
K-Config Example			
Lock the front panel of the VS-1616DN-EM : `#LOCK-FP 1",0x0D`			

MODULE-INFO

Functions		Permission	Transparency
Set	-	-	-
Get	MODULE-INFO?	End User	Public
Description		Syntax	
Set	-	-	
Get	Get module information	#MODULE-INFO? SP slot_id CR	
Response			
~nn@MODULE-INFO SP slot_id,m_direction,channel_start,channel_end,m_type,FW_ver,upgradable_f,status CR LF ? CR LF			
Parameters			
<p>slot_id – Module ID (slot number): 0 (control module), 1-16 (I/O cards), 200 (test module), 201 (keyboard software application), 202 (keyboard hardware)</p> <p>m_direction – Transmission direction: 0 (input), 1 (output), 2 (unknown)</p> <p>channel_start – Start ID of the port in the device: 1-17</p> <p>channel_end – End ID of the port in the device: 1-17</p> <p>m_type – Module type: 0 (DVI), 1 (HDCP), 03 (HDMI), 4 (DL), 06 (HS), 07 (DP), 08 (SDI), 09 (F610), 10 (F670), 12 (DGKat), 16 (VGA), 18 (VGAA), 22 (AAD), 24 (HAA), 25 (HAD), 30 (HDBT), 32 (SDIA), 34 (HDBT7), 41 (UHD), 42 (UHDA), 45 (DTAxx), 47 (control module)</p> <p>FW_ver – Module firmware version: XX.XX.XXXX where the digit groups are: major.minor.build version</p> <p>upgradable_f – Indicates whether the firmware can be upgraded: 0 (not upgradable), 1 (upgradable)</p> <p>status – Module status: 0 (OK), 1 (unknown error), 2 (no communication), 3 (module missing)</p>			
Response Trigger			
Notes			
If m_direction is 2, the channel_start, channel_end and m_type values are irrelevant.			
K-Config Example			
`#MODULE-INFO? 14",0x0D			

MODULE-TYPE

Functions		Permission	Transparency
Set	MODULE-TYPE	Admin	Public
Get	MODULE-TYPE?	End User	Public
Description		Syntax	
Set	Set module type and slot location	# MODULE-TYPE SPm_id,m_typeCR	
Get	Get module type and status by slot location	# MODULE-TYPE? SPm_idCR	
Response			
~nn@ MODULE-TYPE SPm_id,m_type,statusCR LF			
Parameters			
m_id – Module ID (slot number): 0 (control module), 1-16 (I/O cards), 200 (test module), 201 (keyboard software application), 202 (keyboard hardware)			
m_type – Module type: 0 (DVI), 1 (HDCP), 03 (HDMI), 4 (DL), 06 (HS), 07 (DP), 08 (SDI), 09 (F610), 10 (F670), 12 (DGKat), 16 (VGA), 18 (VGAA), 22 (AAD), 24 (HAA), 25 (HAD), 30 (HDBT), 32 (SDIA), 34 (HDBT7), 41 (UHD), 42 (UHDA), 45 (DTAxx), 47 (control module)			
status – Module status: 0 (OK), 1 (unknown error), 2 (no communication), 3 (module missing)			
Response Trigger			
Notes			
K-Config Example			
Set the card (module) installed in slot 4 to HDBT: `#MODULE-TYPE 04, 30", 0x0D`			

MODULE-VER

Functions		Permission	Transparency
Set	-	-	-
Get	MODULE-VER?	End User	Public
Description		Syntax	
Set	-	-	
Get	Get module firmware version	# MODULE-VER? SPm_idCR	
Response			
~nn@ MODULE-VER SPm_id,FW_versionCR LF			
Parameters			
m_id – Module ID (slot number): 0 (control module), 1-16 (I/O cards), 200 (test module), 201 (keyboard software application), 202 (keyboard hardware)			
FW_version – XX.XX.XXXX where the digit groups are: major.minor.build version			
Response Trigger			
Notes			
K-Config Example			
`#MODULE-VER? 15", 0x0D`			

Routing Commands

Command	Description
DISPLAY	Get validity status of output
INFO-IO	Read in/out count
INFO-PRST	Read max preset count
PRST-LST	Read saved presets list
PRST-RCL	Recall saved preset
PRST-STO	Store current connections to preset
PRST-VID	Read video connections from saved preset
SIGNAL	Valid / Invalid input
VID	Switch Video only

DISPLAY

Functions		Permission	Transparency
Set	-	-	-
Get	DISPLAY?	End User	Public
Description		Syntax	
Set	-	-	
Get	Get validity status of output	# DISPLAY? <input type="text" value="SP"/> <input type="text" value="out_id"/> <input type="text" value="CR"/>	
Response			
~ <input type="text" value="nn"/> @DISPLAY <input type="text" value="SP"/> <input type="text" value="out_id,validity_flag"/> <input type="text" value="CR LF"/>			
Parameters			
<i>out_id</i> – output number: 1-16 (varies according to installed output cards, see Port Numbering on page 12)			
<i>validity_flag</i> – validity status of output: 0 (output is invalid – HPD off), 1 (output is valid – HPD on)			
Response Trigger			
A response is sent to the com port from which the Get was received, after command execution and: After every change in output HPD status from on to off (0) After every change in output HPD status from off to on (1)			
Notes			
K-Config Example			
Get the validity status of output 8: `#DISPLAY 8",0x0D			

INFO-IO

Functions		Permission	Transparency
Set	-	-	-
Get	INFO-IO?	End User	Public
Description		Syntax	
Set	-	-	
Get	Get in/out count	# INFO-IO? <code>[CR]</code>	
Response			
~ <code>[nn]</code> @ INFO-IO? <code>[SP]</code> IN <code>[SP]</code> <i>inputs_count</i> ,OUT <code>[SP]</code> <i>outputs_count</i> <code>[CR LF]</code>			
Parameters			
<i>inputs_count</i> – number of inputs in the unit <i>outputs_count</i> – number of outputs in the unit			
Response Trigger			
Notes			
K-Config Example			
"#INFO-IO?", 0x0D			

INFO-PRST

Functions		Permission	Transparency
Set	-	-	-
Get	INFO-PRST?	End User	Public
Description		Syntax	
Set	-	-	
Get	Get maximum preset count	# INFO-PRST? <code>[CR]</code>	
Response			
~ <code>[nn]</code> @ INFO-PRST? <code>[SP]</code> VID <code>[SP]</code> <i>preset_video_count</i> ,AUD <code>[SP]</code> <i>preset_audio_count</i> <code>[CR LF]</code>			
Parameters			
<i>preset_video_count</i> – maximum number of video presets in the unit <i>preset_audio_count</i> – maximum number of audio presets in the unit			
Response Trigger			
Notes			
In most units, video and audio presets with the same number are stored and recalled together by commands #PRST-STO and #PRST-RCL			
K-Config Example			
"#INFO-PRST?", 0x0D			

PRST-LST

Functions		Permission	Transparency
Set	-	-	-
Get	PRST-LST?	End User	Public
Description		Syntax	
Set	-	-	
Get	Get list of saved presets	# PRST-LST? <code>CR</code>	
Response			
~ <code>nn</code> @ PRST-LST <code>SP</code> <i>preset,preset,...</i> <code>CR LF</code>			
Parameters			
<i>preset</i> – preset number: 1-60			
Response Trigger			
Notes			
In most units, video and audio presets with the same number are stored and recalled together by commands # PRST-STO and # PRST-RCL			
K-Config Example			
`# PRST-LST? `,0x0D			

PRST-RCL

Functions		Permission	Transparency
Set	PRST-RCL	End User	Public
Get	-	-	-
Description		Syntax	
Set	Recall (load) a saved preset	# PRST-RCL <code>SP</code> <i>preset</i> <code>CR</code>	
Get	-	-	
Response			
~ <code>nn</code> @ PRST-RCL <code>SP</code> <i>preset</i> <code>CR LF</code>			
Parameters			
<i>preset</i> – preset number: 1-60			
Response Trigger			
Notes			
In most units, video and audio presets with the same number are stored and recalled together by commands # PRST-STO and # PRST-RCL			
K-Config Example			
Recall previously saved connections, volumes, and modes (audio and video routing table) from preset 5: `# PRST-RCL 5`,0x0D			

PRST-STO

Functions		Permission	Transparency
Set	PRST-STO	End User	Public
Get	-	-	-
Description		Syntax	
Set	Store current connections, volumes and modes as a preset	# PRST-STO [SP]preset[CR]	
Get	-	-	
Response			
~nn@ PRST-STO [SP]preset[CR LF]			
Parameters			
<i>preset</i> – preset number: 1-60			
Response Trigger			
Notes			
In most units, video and audio presets with the same number are stored and recalled together by commands # PRST-STO and # PRST-RCL			
K-Config Example			
Store the current connections, volumes, and modes (audio and video routing table) to preset 8: `# PRST-STO 8",0x0D			

PRST-VID

Functions		Permission	Transparency
Set	-	-	-
Get	PRST-VID?	End User	Public
Description		Syntax	
Set	-	-	
Get	Get video connections from saved preset	# PRST-VID? [SP]preset,out[CR] # PRST-VID? [SP]preset,*[CR]	
Response			
~nn@ PRST-VID [SP]preset,in>out[CR LF]			
or			
~nn@ PRST-VID [SP]preset,in>1,in>2,in>3,...[CR LF]			
Parameters			
<i>preset</i> – preset number: 1-60			
<i>in</i> – input number: 0 (if output disconnected), 1-16 (varies according to installed input cards, see Port Numbering on page 12)			
> – connection character between in and out parameters			
<i>out</i> – output number: 1-16 (varies according to installed output cards, see Port Numbering on page 12),			
* (all outputs)			
Response Trigger			
Notes			
In most units, video and audio presets with the same number are stored and recalled together by commands # PRST-STO and # PRST-RCL			
K-Config Example			
Get the source of video output 2 from preset 3: `# PRST-VID? 3,2",0x0D			

SIGNAL

Functions		Permission	Transparency
Set	-	-	-
Get	SIGNAL?	End User	Public
Description		Syntax	
Set	-	-	
Get	Get input signal validity status	# SIGNAL? <code>[SP]</code> <i>inp_id</i> <code>[CR]</code>	
Response			
~ <code>[nn]</code> @ SIGNAL <code>[SP]</code> <i>inp_id,validity_flag</i> <code>[CR LF]</code>			
Parameters			
<i>inp_id</i> – input number: 1-16 (varies according to installed input cards, see Port Numbering on page 12)			
<i>validity_flag</i> – validity status according to signal validation: 0 (input is invalid), 1 (input is valid)			
Response Trigger			
After execution, a response is sent to the com port from which the Get was received Response is sent after every change in input signal status valid to invalid, or invalid to valid			
Notes			
K-Config Example			
Get the input signal lock status of input 2: `#SIGNAL? 2",0x0D`			

VID

Functions		Permission	Transparency
Set	VID	End User	Public
Get	VID?	End User	Public
Description		Syntax	
Set	Set video switch state	#VID[SP]in>out,in>out,...[CR]	
Get	Get video switch state	#VID?[SP]out[CR] #VID?[SP]*[CR]	
Response			
Set: ~nn@VID[SP]in>out[CR LF] ~nn@VID[SP]in>out[CR LF] ... Get: ~nn@VID[SP]in>out[CR LF] ~nn@VID[SP]in>1,in>2,...[CR LF]			
Parameters			
<i>in</i> – input number: 0 (if output disconnected), 1-16 (varies according to installed input cards, see Port Numbering on page 12) > – connection character between in and out parameters <i>out</i> – output number: 1-16 (varies according to installed output cards, see Port Numbering on page 12), * (all outputs)			
Response Trigger			
Notes			
Examples			
Switch video input 2 to output 4	#V 2>4[CR]	~01@VID 2>4[CR LF]	
Switch video input 4 to output 2 in machine 6	#6@VID 4>2[CR]	~06@VID 4>2[CR LF]	
Switch video input 3 to all outputs	#V 3>*[CR]	~01@VID 3>*[CR LF]	
Chaining multiple commands	V 3>4,2>2,2>1,0>2 V 3>9 *[CR] 1. Switch video input 3 to output 4, video input 2 to output 2, video input 2 to output 1 and disconnect video output 2 2. Switch video input 3 to output 9 (non- existent) 3. Get status of all video links Command processing begins after entering [CR] A response is sent for each command after processing	~VID 3>4 [CR LF] ~VID 2>2 [CR LF] ~VID 2>1 [CR LF] ~VID 0>2 [CR LF] ~VID [ERR003] [CR LF] ~VID 2>1,0>2,1>3, 3>4[CR LF]	
K-Config Example			
Set the video switch state from input 4 to output 2: "#VID 4>2", 0x0D			

Video Commands

Command	Description
BRIGHTNESS	Set/get brightness value
CONTRAST	Set/get contrast value
DETAIL-TIMING	Set/get detailed timing parameters
H-PHASE	Set/get H-Phase value

BRIGHTNESS

Functions		Permission	Transparency
Set	BRIGHTNESS	End User	Public
Get	BRIGHTNESS?	End User	Public
Description		Syntax	
Set	Set brightness value	# BRIGHTNESS <u>SP</u> stage, channel, value <u>CR</u>	
Get	Get brightness value	# BRIGHTNESS? <u>SP</u> stage, channel <u>CR</u>	
Response			
~ <u>nn</u> @ BRIGHTNESS <u>SP</u> stage, channel, value <u>CR LF</u>			
Parameters			
stage – 1/IN (input), 2/OUT (output)			
channel – input or output number: 1–16 (varies according to installed input / output cards, see Port Numbering on page 12)			
value – brightness in Kramer units: 0–63, ++ (increase current value), -- (decrease current value)			
Response Trigger			
Notes			
A minus sign precedes negative values			
This command is only valid for VGA cards			
K-Config Example			
Set the brightness value of output 8 to 60: `#BRIGHTNESS 2, 8, 60", 0x0D`			
Increase the brightness value of input 5 by 1 unit: `#BRIGHTNESS 1, 5, ++", 0x0D`			

CONTRAST

Functions		Permission	Transparency
Set	CONTRAST	End User	Public
Get	CONTRAST?	End User	Public
Description		Syntax	
Set	Set contrast value	# CONTRAST [SP]stage,channel,value[CR]	
Get	Get contrast value	# CONTRAST? [SP]stage,channel[CR]	
Response			
~nn@ CONTRAST [SP]stage,channel,value[CR LF]			
Parameters			
stage – 1/IN (input), 2/OUT (output)			
channel – input or output number: 1-16 (varies according to installed input / output cards, see Port Numbering on page 12)			
value – contrast in Kramer units: 0-63, ++ (increase current value), -- (decrease current value)			
Response Trigger			
Notes			
A minus sign precedes negative values			
This command is only valid for VGA cards			
K-Config Example			
Set the contrast value of output 8 to 60: `#CONTRAST 2,8,60`,0x0D			
Increase the contrast value of input 5 by 1 unit: `#CONTRAST 1,5,++`,0x0D			

DETAIL-TIMING

Functions		Permission	Transparency
Set	DETAIL-TIMING	End User	Public
Get	DETAIL-TIMING?	End User	Public
Description		Syntax	
Set	Set detailed timing parameters	# DETAIL-TIMING [SP]param, channel, value[CR]	
Get	Get detailed timing parameters	# DETAIL-TIMING? [SP]param, channel[CR]	
Response			
~nn@ DETAIL-TIMING [SP]param, channel, value[CR LF]			
Parameters			
<p>param – 1 (H-De-Start – horizontal start position of port video), 2 (H-De-Total – horizontal active pixels of port video), 3 (H-Total – total horizontal pixels of port video), 4 (V-De-Start – vertical start position of port video), 5 (V-De-Total – vertical active lines of port video), 6 (Auto-DE-Adjust – resolution detection mode), 7 (Auto-PHASE-Adjust – phase mode)</p> <p>channel – input number: 1-16 (varies according to installed input cards, see Port Numbering on page 12)</p> <p>value – video parameter value in Kramer units:</p> <ul style="list-style-type: none"> for all param values: ++ (increase current value), -- (decrease current value) for 1 (H-De-Start): 1-600 for 2 (H-De-Total): 1-4000 for 3 (H-Total): 1-7000 for 4 (V-De-Start): 1-255 for 5 (V-De-Total): 1-3000 for 6 (Auto-DE-Adjust): 0 (auto), 1 (user defined), 2 (auto adjust) for 7 (Auto-PHASE-Adjust): 0 (auto), 1 (user defined), 2 (auto adjust) 			
Response Trigger			
Notes			
<p>A minus sign precedes negative values.</p> <p>The auto adjust feature (in the Auto-DE-Adjust and Auto-PHASE-Adjust parameters) requires the device to recalculate the parameters based on the currently connected source. The result may be different from the standard parameters for the currently set resolution. The result is saved in non-volatile memory and is recalled when the same source is used again. In order to revert to auto pre-defined parameters, either reset to factory setting with the relevant source connected or connect a different source.</p>			
K-Config Example			
<p>Set the total horizontal pixels (H-Total parameter) of input 4 to 6000:</p> <pre>"#DETAIL-TIMING 3,4,6000",0x0D</pre> <p>Set the resolution detection mode (Auto-DE-Adjust parameter) of input 4 to auto adjust:</p> <pre>"#DETAIL-TIMING 6,4,2",0x0D</pre>			

H-PHASE

Functions		Permission	Transparency
Set	H-PHASE	End User	Public
Get	H-PHASE?	End User	Public
Description		Syntax	
Set	Set H-Phase value	# H-PHASE [SP]stage,channel,value[CR]	
Get	Get H-Phase value	# H-PHASE? [SP]stage,channel[CR]	
Response			
~nn@ H-PHASE [SP]stage,channel,value[CR LF]			
Parameters			
stage – 1/IN (input), 2/OUT (output)			
channel – input or output number: 1-16 (varies according to installed input / output cards, see Port Numbering on page 12)			
value – H-Phase value in Kramer units: 0-63, ++ (increase current value), -- (decrease current value)			
Response Trigger			
Notes			
A minus sign precedes negative values			
This command is only valid for VGA cards			
K-Config Example			
Set the H-Phase value of output 8 to 60: `#H-PHASE 2,8,60",0x0D`			
Increase the H-Phase value of input 5 by 1 unit: `#H-PHASE 1,5,++",0x0D`			

Audio Commands

Command	Description
AUD-LVL	Set/get audio level in specific amplifier stage
BALANCE	Set/get balance level
BASS	Set/get audio bass level
MIX	Set/get audio mix setting (stereo / mono)
MUTE	Set/get audio mute setting
TREBLE	Set/get audio treble level
VOLUME	Set/get simple audio volume

AUD-LVL

Functions		Permission	Transparency
Set	AUD-LVL	End User	Public
Get	AUD-LVL?	End User	Public
Description		Syntax	
Set	Set audio level in specific amplifier stage	#AUD-LVL[SP]stage, channel, volume[CR]	
Get	Get audio level in specific amplifier stage	#AUD-LVL?[SP]stage, channel[CR]	
Response			
~nn@AUD-LVL[SP]stage, channel, volume[CR LF]			
Parameters			
stage – 0/IN (input), 1/OUT (output)			
channel – input or output number: 1-16 (varies according to installed input / output cards, see Port Numbering on page 12)			
volume – audio level in Kramer units: 0-70, ++ (increase current value), -- (decrease current value)			
Response Trigger			
Notes			
The VOLUME command can also be used to set simple output audio volume. A minus sign precedes negative values.			
K-Config Example			
Set the audio level of output 8 to 30: `#AUD-LVL 2, 8, 30`, 0x0D			
Increase the audio level of input 3 by 1 unit: `#AUD-LVL 1, 3, ++`, 0x0D			

BALANCE

Functions		Permission	Transparency
Set	BALANCE	End User	Public
Get	BALANCE?	End User	Public
Description		Syntax	
Set	Set the balance level	# BALANCE [SP]out_channel,balance_level[CR]	
Get	Get the current balance level	# BALANCE? [SP]out_channel[CR]	
Response			
~nn@ BALANCE [SP]out_channel,balance_level[CR LF]			
Parameters			
out_channel – output number: 1-16 (varies according to installed output cards, see Port Numbering on page 12)			
balance_level – balance level in Kramer units: 0-100, ++ (increase current value), -- (decrease current value)			
Response Trigger			
Notes			
A minus sign precedes negative values			
K-Config Example			
Set the balance level of output 5 to 50: `#BALANCE 5,50",0x0D			
Increase the balance level of output 5 by 1 unit: `#BALANCE 5,++",0x0D			

BASS

Functions		Permission	Transparency
Set	BASS	End User	Public
Get	BASS?	End User	Public
Description		Syntax	
Set	Set the audio bass level	# BASS [SP]channel,bass_level[CR]	
Get	Get the current audio bass level	# BASS? [SP]channel[CR]	
Response			
~nn@ BASS [SP]channel,bass_level[CR LF]			
Parameters			
channel – output number: 1-16 (varies according to installed output cards, see Port Numbering on page 12)			
bass_level – bass level in Kramer units: 0-15, ++ (increase current value), -- (decrease current value)			
Response Trigger			
Notes			
A minus sign precedes negative values			
K-Config Example			
Set the bass level of output 10 to 4: `#BASS 10,4",0x0D			
Decrease the bass level of output 5 by 1 unit: `#BASS 5,--",0x0D			

MIX

Functions		Permission	Transparency
Set	MIX	End User	Public
Get	MIX?	End User	Public
Description		Syntax	
Set	Set audio mix (stereo/mono)	# MIX [SP]channel,mix_mode[CR]	
Get	Get audio mix setting (stereo/mono)	# MIX? [SP]channel[CR]	
Response			
~nn@ MIX [SP]channel,mix_mode[CR LF]			
Parameters			
channel – output number: 1-16 (varies according to installed output cards, see Port Numbering on page 12)			
mix_mode – mix mode setting: 0/OFF (analog audio output is stereo), 1/ON (analog audio output is mono)			
Response Trigger			
Notes			
Mix mode is an analog audio parameter used to set mono or stereo output			
K-Config Example			
Set the mix mode of output 3 to off (stereo output): `#MIX 3,0",0x0D			

MUTE

Functions		Permission	Transparency
Set	MUTE	End User	Public
Get	MUTE?	End User	Public
Description		Syntax	
Set	Mute the audio output	# MUTE [SP]channel,mute_mode[CR]	
Get	Get audio mute setting	# MUTE? [SP]channel[CR]	
Response			
~nn@ MUTE [SP]channel,mute_mode[CR LF]			
Parameters			
channel – output number: 1-16 (varies according to installed output cards, see Port Numbering on page 12)			
mute_mode – audio mute setting: 0/OFF (audio is enabled), 1/ON (audio is muted)			
Response Trigger			
Notes			
K-Config Example			
Mute the audio of output 8: `#MUTE 8,1",0x0D			

TREBLE

Functions		Permission	Transparency
Set	TREBLE	End User	Public
Get	TREBLE?	End User	Public
Description		Syntax	
Set	Set the audio treble value	# TREBLE [SP]channel,treble_level[CR]	
Get	Get the audio treble value	# TREBLE? [SP]channel[CR]	
Response			
~nn@ TREBLE [SP]channel,treble_level[CR LF]			
Parameters			
channel – output number: 1-16 (varies according to installed output cards, see Port Numbering on page 12)			
treble_level – treble level in Kramer units: 0-15, ++ (increase current value), -- (decrease current value)			
Response Trigger			
Notes			
A minus sign precedes negative values			
K-Config Example			
Set the audio treble level of output 8 to 7: `#TREBLE 8,7",0x0D			
Decrease the treble level of output 5 by 1 unit: `#TREBLE 5,--,0x0D			

VOLUME

Functions		Permission	Transparency
Set	VOLUME	End User	Public
Get	VOLUME?	End User	Public
Description		Syntax	
Set	Set simple audio volume	# VOLUME [SP]out_channel,volume[CR]	
Get	Get simple audio volume	# VOLUME? [SP]out_channel[CR]	
Response			
~nn@ VOLUME [SP]out_channel,volume[CR LF]			
Parameters			
out_channel – output number: 1-16 (varies according to installed output cards, see Port Numbering on page 12)			
volume – volume in Kramer units: 0-70, ++ (increase current value), -- (decrease current value)			
Response Trigger			
Notes			
A minus sign precedes negative values			
Use the AUD-LVL command to set / get the input audio level or the audio level in the amplifier stage.			
K-Config Example			
Set the volume of output 8 to 25: `#VOLUME 8,25",0x0D			
Increase the volume of output 5 by 1 unit: `#VOLUME 5,++,0x0D			

Using the Packet Protocol

The packet protocol is designed to transfer large amounts of data, such as files, IR commands, EDID data, etc.

To use the packet protocol:

1. Send a command, for example `LDEID`
2. Receive `READY` or `ERR###`
3. If `READY`:
 - Send a packet
 - Receive `OK` on the last packet
 - Receive `OK` for the command
4. Packet structure:
 - Packet ID (1, 2, 3...) (2 bytes in length)
 - Length (data length + 2 for CRC) – (2 bytes in length)
 - Data (data length -2 bytes)
 - CRC - 2 bytes

01	02	03	04	05...	
Packet ID	Length	Data	CRC		

5. Response:

```
~NNNN[SP]OK[CR LF]
```

Where NNNN is the received packet ID in ASCII hex digits.



When calculating the CRC, the polynomial for the 16-bit CRC is:
 CRC-CCITT: $0x1021 = x^{16} + x^{12} + x^5 + 1$
 Initial value: 0000
 Final XOR Value: 0

For a code example, see: sanity-free.org/133/crc_16_ccitt_in_csharp.html

CRC example:

Data = "123456789"

Result => 0x31C3

The warranty obligations of Kramer Electronics Inc. ("Kramer Electronics") for this product are limited to the terms set forth below:

What is Covered

This limited warranty covers defects in materials and workmanship in this product.

What is Not Covered

This limited warranty does not cover any damage, deterioration or malfunction resulting from any alteration, modification, improper or unreasonable use or maintenance, misuse, abuse, accident, neglect, exposure to excess moisture, fire, improper packing and shipping (such claims must be presented to the carrier), lightning, power surges, or other acts of nature. This limited warranty does not cover any damage, deterioration or malfunction resulting from the installation or removal of this product from any installation, any unauthorized tampering with this product, any repairs attempted by anyone unauthorized by Kramer Electronics to make such repairs, or any other cause which does not relate directly to a defect in materials and/or workmanship of this product. This limited warranty does not cover cartons, equipment enclosures, cables or accessories used in conjunction with this product. Without limiting any other exclusion herein, Kramer Electronics does not warrant that the product covered hereby, including, without limitation, the technology and/or integrated circuit(s) included in the product, will not become obsolete or that such items are or will remain compatible with any other product or technology with which the product may be used.

How Long this Coverage Lasts

The standard limited warranty for Kramer products is seven (7) years from the date of original purchase, with the following exceptions:

1. All Kramer VIA hardware products are covered by a standard three (3) year warranty for the VIA hardware and a standard three (3) year warranty for firmware and software updates; all Kramer VIA accessories, adapters, tags, and dongles are covered by a standard one (1) year warranty.
2. Kramer fiber optic cables, adapter-size fiber optic extenders, pluggable optical modules, active cables, cable retractors, ring mounted adapters, portable power chargers, Kramer speakers, and Kramer touch panels are all covered by a standard one (1) year warranty.
3. All Kramer Cobra products, all Kramer Calibre products, all Kramer Minicom digital signage products, all HighSecLabs products, all streaming, and all wireless products are covered by a standard three (3) year warranty.
4. All Sierra Video MultiViewers are covered by a standard five (5) year warranty.
5. Sierra switchers & control panels are covered by a standard seven (7) year warranty (excluding power supplies and fans that are covered for three (3) years).
6. K-Touch software is covered by a standard one (1) year warranty for software updates.
7. All Kramer passive cables are covered by a ten (10) year warranty.

Who is Covered

Only the original purchaser of this product is covered under this limited warranty. This limited warranty is not transferable to subsequent purchasers or owners of this product.

What Kramer Electronics Will Do

Kramer Electronics will, at its sole option, provide one of the following three remedies to whatever extent it shall deem necessary to satisfy a proper claim under this limited warranty:

1. Elect to repair or facilitate the repair of any defective parts within a reasonable period of time, free of any charge for the necessary parts and labor to complete the repair and restore this product to its proper operating condition. Kramer Electronics will also pay the shipping costs necessary to return this product once the repair is complete.
2. Replace this product with a direct replacement or with a similar product deemed by Kramer Electronics to perform substantially the same function as the original product. If a direct or similar replacement product is supplied, the original product's end warranty date remains unchanged and is transferred to the replacement product.
3. Issue a refund of the original purchase price less depreciation to be determined based on the age of the product at the time remedy is sought under this limited warranty.

What Kramer Electronics Will Not Do Under This Limited Warranty

If this product is returned to Kramer Electronics or the authorized dealer from which it was purchased or any other party authorized to repair Kramer Electronics products, this product must be insured during shipment, with the insurance and shipping charges prepaid by you. If this product is returned uninsured, you assume all risks of loss or damage during shipment. Kramer Electronics will not be responsible for any costs related to the removal or re-installation of this product from or into any installation. Kramer Electronics will not be responsible for any costs related to any setting up this product, any adjustment of user controls or any programming required for a specific installation of this product.

How to Obtain a Remedy Under This Limited Warranty

To obtain a remedy under this limited warranty, you must contact either the authorized Kramer Electronics reseller from whom you purchased this product or the Kramer Electronics office nearest you. For a list of authorized Kramer Electronics resellers and/or Kramer Electronics authorized service providers, visit our web site at www.kramerav.com or contact the Kramer Electronics office nearest you.

In order to pursue any remedy under this limited warranty, you must possess an original, dated receipt as proof of purchase from an authorized Kramer Electronics reseller. If this product is returned under this limited warranty, a return authorization number, obtained from Kramer Electronics, will be required (RMA number). You may also be directed to an authorized reseller or a person authorized by Kramer Electronics to repair the product.

If it is decided that this product should be returned directly to Kramer Electronics, this product should be properly packed, preferably in the original carton, for shipping. Cartons not bearing a return authorization number will be refused.

Limitation of Liability

THE MAXIMUM LIABILITY OF KRAMER ELECTRONICS UNDER THIS LIMITED WARRANTY SHALL NOT EXCEED THE ACTUAL PURCHASE PRICE PAID FOR THE PRODUCT. TO THE MAXIMUM EXTENT PERMITTED BY LAW, KRAMER ELECTRONICS IS NOT RESPONSIBLE FOR DIRECT, SPECIAL, INCIDENTAL OR CONSEQUENTIAL DAMAGES RESULTING FROM ANY BREACH OF WARRANTY OR CONDITION, OR UNDER ANY OTHER LEGAL THEORY. Some countries, districts or states do not allow the exclusion or limitation of relief, special, incidental, consequential or indirect damages, or the limitation of liability to specified amounts, so the above limitations or exclusions may not apply to you.

Exclusive Remedy

TO THE MAXIMUM EXTENT PERMITTED BY LAW, THIS LIMITED WARRANTY AND THE REMEDIES SET FORTH ABOVE ARE EXCLUSIVE AND IN LIEU OF ALL OTHER WARRANTIES, REMEDIES AND CONDITIONS, WHETHER ORAL OR WRITTEN, EXPRESS OR IMPLIED. TO THE MAXIMUM EXTENT PERMITTED BY LAW, KRAMER ELECTRONICS SPECIFICALLY DISCLAIMS ANY AND ALL IMPLIED WARRANTIES, INCLUDING, WITHOUT LIMITATION, WARRANTIES OF MERCHANTABILITY AND FITNESS FOR A PARTICULAR PURPOSE. IF KRAMER ELECTRONICS CANNOT LAWFULLY DISCLAIM OR EXCLUDE IMPLIED WARRANTIES UNDER APPLICABLE LAW, THEN ALL IMPLIED WARRANTIES COVERING THIS PRODUCT, INCLUDING WARRANTIES OF MERCHANTABILITY AND FITNESS FOR A PARTICULAR PURPOSE, SHALL APPLY TO THIS PRODUCT AS PROVIDED UNDER APPLICABLE LAW.

IF ANY PRODUCT TO WHICH THIS LIMITED WARRANTY APPLIES IS A "CONSUMER PRODUCT" UNDER THE MAGNUSON-MOSS WARRANTY ACT (15 U.S.C.A. §2301, ET SEQ.) OR OTHER APPLICABLE LAW, THE FOREGOING DISCLAIMER OF IMPLIED WARRANTIES SHALL NOT APPLY TO YOU, AND ALL IMPLIED WARRANTIES ON THIS PRODUCT, INCLUDING WARRANTIES OF MERCHANTABILITY AND FITNESS FOR THE PARTICULAR PURPOSE, SHALL APPLY AS PROVIDED UNDER APPLICABLE LAW.

Other Conditions

This limited warranty gives you specific legal rights, and you may have other rights which vary from country to country or state to state.

This limited warranty is void if (i) the label bearing the serial number of this product has been removed or defaced, (ii) the product is not distributed by Kramer Electronics or (iii) this product is not purchased from an authorized Kramer Electronics reseller. If you are unsure whether a reseller is an authorized Kramer Electronics reseller, visit our web site at www.kramerav.com or contact a Kramer Electronics office from the list at the end of this document.

Your rights under this limited warranty are not diminished if you do not complete and return the product registration form or complete and submit the online product registration form. Kramer Electronics thanks you for purchasing a Kramer Electronics product. We hope it will give you years of satisfaction.



P/N:



2900-300928

Rev:



7



SAFETY WARNING

Disconnect the unit from the power supply before opening and servicing

For the latest information on our products and a list of Kramer distributors, visit our Web site where updates to this user manual may be found.

We welcome your questions, comments, and feedback.

The terms HDMI, HDMI High-Definition Multimedia Interface, and the HDMI Logo are trademarks or registered trademarks of HDMI Licensing Administrator, Inc. All brand names, product names, and trademarks are the property of their respective owners.