



KRAMER ELECTRONICS LTD.

USER MANUAL

MODEL:

VS-44HDxI

3G HD/SD-SDI 4x4 Matrix
Switcher

P/N: 2900-000476 Rev 4



VS-44HDxI Quick Start Guide

This guide helps you install and use your product for the first time. For more detailed information, go to http://www.kramerelectronics.com/support/product_downloads.asp to download the latest manual or scan the QR code on the left.

Step 1: Check what's in the box

- VS-44HDxI 3G HD/SD-SDI 4x4 Matrix Switcher
- 1 Power cord
- 4 Rubber feet
- 1 Quick Start sheet
- Kramer RC-IR3 Infrared Remote Control Transmitter with batteries and user manual

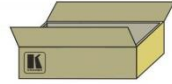

Save the original box and packaging materials should you need to return your VS-44HDxI for service.

Step 2: Install the VS-44HDxI

Mount the VS-44HDxI in a rack (using the included rack "ears") or attach the rubber feet and place on a table.

Step 3: Connect the inputs and outputs

Always switch off the power on each device before connecting it to your VS-44HDxI.

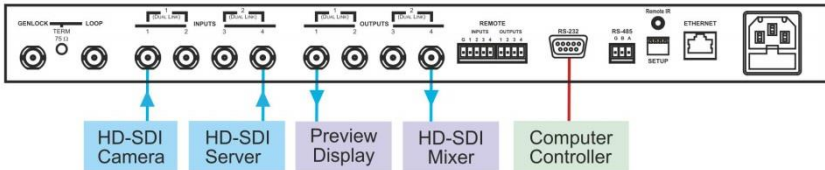

Connect a genlock source and loop. Connect the remote contact closure terminal block.

Always use Kramer high-performance cables for connecting AV equipment to the VS-44HDxI.

Step 4: Connect the power

Connect the power cord to the VS-44HDxI and plug it into the mains electricity.



Step 5: Operate the VS-44HDxI

Set DIP-switches for the machine number:

1 2 3 4



SETUP

Mach. #	DIP 1	DIP 2	DIP 3	DIP 4
1 (default)	OFF	OFF	OFF	OFF
2	OFF	OFF	OFF	ON
3	OFF	OFF	ON	OFF
4	OFF	OFF	ON	ON
5	OFF	ON	OFF	OFF
6	OFF	ON	OFF	ON
7	OFF	ON	ON	OFF
8	OFF	ON	ON	ON

TAKE - Confirms actions
 ALL - Selected input to all outputs
 OFF - Press & hold 3 secs to enter/exit dual-link mode
 STO - Stores status
 RCL - Recalls status
 LOCK - Locks front panel

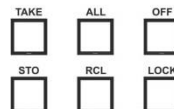

Contents

1	Introduction	1
2	Getting Started	2
2.1	Achieving the Best Performance	2
2.2	Safety Instructions	3
2.3	Recycling Kramer Products	3
3	Overview	4
3.1	Defining the VS-44HDxl 3G HD/SD-SDI 4x4 Matrix Switcher	5
4	Installing in a Rack	8
4.1	Using the IR Transmitter	9
5	Connecting the VS-44HDxl	10
5.1	Connecting the VS-44HDxl in Single-Link Mode	10
5.2	Connecting the VS-44HDxl in the Dual-Link Mode	12
5.3	Setting the Working Mode	13
5.4	Setting the DIP-Switches	14
5.5	Connecting the RS-232 Port	15
5.6	Connecting a PC or Controller to the RS-485 Port	16
5.7	Performing a Factory Reset	16
5.8	Switching Genlocked Video Signals	16
5.9	Operating via Ethernet	17
5.10	Controlling via the REMOTE Connector	21
6	Operating the VS-44HDxl	22
6.1	Switching Combinations	22
6.2	Confirming Settings	23
6.3	Storing/Recalling Input/Output Configurations	25
6.4	Locking the Front Panel	26
7	Technical Specifications	27
8	Table of Hex Codes for Serial Communication	28
9	Protocol 2000	29
9.1	Syntax	29
9.2	Instruction Codes	30

Figures

Figure 1: VS-44HDxl 3G HD/SD-SDI 4x4 Matrix Switcher Front Panel	6
Figure 2: VS-44HDxl 3G HD/SD-SDI 4x4 Matrix Switcher Rear Panel	7
Figure 3: Connecting the VS-44HDxl 3G HD/SD-SDI 4x4 Matrix Switcher	11
Figure 4: Connecting the Dual-Link VS-44HDxl 3G HD/SD-SDI 4x4 Matrix Switcher	13
Figure 5: VS-44HDxl SETUP DIP-switches	14
Figure 6: Crossed Cable RS-232 Connection	15
Figure 7: Straight Cable RS-232 Connection with a Null Modem Adapter	15
Figure 8: Local Area Connection Properties Window	18
Figure 9: Internet Protocol Version 4 Properties Window	19
Figure 10: Internet Protocol Version 6 Properties Window	19
Figure 11: Internet Protocol Properties Window	20
Figure 12: Using the REMOTE Connector	21

1 Introduction

Welcome to Kramer Electronics! Since 1981, Kramer Electronics has been providing a world of unique, creative, and affordable solutions to the vast range of problems that confront video, audio, presentation, and broadcasting professionals on a daily basis. In recent years, we have redesigned and upgraded most of our line, making the best even better!

Our 1,000-plus different models now appear in 11 groups that are clearly defined by function: GROUP 1: Distribution Amplifiers; GROUP 2: Switchers and Routers; GROUP 3: Control Systems; GROUP 4: Format/Standards Converters; GROUP 5: Range Extenders and Repeaters; GROUP 6: Specialty AV Products; GROUP 7: Scan Converters and Scalers; GROUP 8: Cables and Connectors; GROUP 9: Room Connectivity; GROUP 10: Accessories and Rack Adapters and GROUP 11: Sierra Products.

Congratulations on purchasing your Kramer **VS-44HDxI 3G HD/SD-SDI 4x4 Matrix Switcher**, which is ideal for the following typical applications:

- Broadcasting and production studios
- Presentation applications

2 Getting Started

We recommend that you:

- Unpack the equipment carefully and save the original box and packaging materials for possible future shipment
- Review the contents of this user manual



Go to http://www.kramerelectronics.com/support/product_downloads.asp to check for up-to-date user manuals, application programs, and to check if firmware upgrades are available (where appropriate).

2.1 Achieving the Best Performance

To achieve the best performance:

- Use only good quality connection cables (we recommend Kramer high-performance, high-resolution cables) to avoid interference, deterioration in signal quality due to poor matching, and elevated noise levels (often associated with low quality cables)
- Do not secure the cables in tight bundles or roll the slack into tight coils
- Avoid interference from neighboring electrical appliances that may adversely influence signal quality
- Position your Kramer **VS-44HDxI** away from moisture, excessive sunlight and dust



This equipment is to be used only inside a building. It may only be connected to other equipment that is installed inside a building.

2.2 Safety Instructions



Caution: There are no operator serviceable parts inside the unit

Warning: Use only the power cord that is supplied with the unit

Warning: Do not open the unit. High voltages can cause electrical shock! Servicing by qualified personnel only

Warning: Disconnect the power and unplug the unit from the wall before installing

2.3 Recycling Kramer Products

The Waste Electrical and Electronic Equipment (WEEE) Directive 2002/96/EC aims to reduce the amount of WEEE sent for disposal to landfill or incineration by requiring it to be collected and recycled. To comply with the WEEE Directive, Kramer Electronics has made arrangements with the European Advanced Recycling Network (EARN) and covers any costs of treatment, recycling and recovery of waste Kramer Electronics branded equipment on arrival at the EARN facility. For details of Kramer's recycling arrangements in your particular country go to our recycling pages at <http://www.kramerelectronics.com/support/recycling/>.

3 Overview

The **VS-44HDxI** is a high-performance matrix switcher for 3G HD-SDI and HD-SDI dual link video signals. The unit can be used as a high performance 4x4 matrix switcher or as a dual-link 2x2 switcher that lets you simultaneously route any of the inputs to any or all of the outputs for all SDI video signals, using BNC connectors. Switching is implemented during the vertical interval period according to the SMPTE RP-168 standard, when using synchronized digital video sources.

In particular, the **VS-44HDxI** features:

- A maximum data rate of 3Gbps
- HDTV compatibility
- Multi-standard operation - SDI (SMPTE 259M/344M), HD-SDI (SMPTE 292M), 3G HD-SDI (SMPTE 424M), and dual link HD-SDI (SMPTE 372M)
- Kramer Equalization & re-Klocking™ Technology that rebuilds the digital signal to travel longer distances
- Switching synchronization that synchronizes either to external reference or incoming video
- Active Input Type™ reporting where each input button on the front panel automatically lights up when the unit detects a video signal on that input. Green indicates a standard definition (SDI) input signal and blue indicates a high-definition (HD-SDI) input signal
- Multiple Memory Locations that store multiple switches as presets (salvos) to be recalled and executed when needed
- A take button that executes multiple switches all at once
- Bi-level, tri-level analog sync
- Selectable sync signal termination
- Looping sync input
- Front panel control lockout

- Flexible control options: front panel, RS-232 (K-Router™ Windows®-based software is included), RS-485, Ethernet, contact closure & IR Remote (included)
- Worldwide power supply of 100-240V AC
- Standard 19" rack mount size, 1U with rack "ears" included

The **VS-44HDxI**, which is housed in a 19" 1U rack mountable enclosure, and is fed from a 100-240V AC universal switching power supply, can be controlled via the front panel buttons or via the:

- Infrared remote control transmitter
- Infrared remote extension cable transmitter
- Remotely, by RS-232 or RS-485 serial commands transmitted by a touch screen system, PC, or other serial controller
- Ethernet
- Remote contact closure for forced operation

3.1 Defining the VS-44HDxI 3G HD/SD-SDI 4x4 Matrix Switcher

This section defines the **VS-44HDxI**.

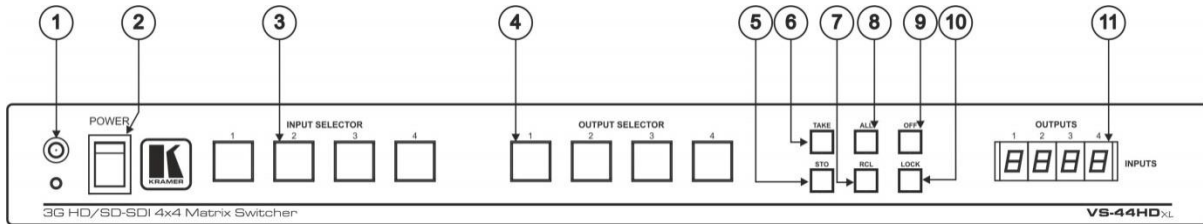

Figure 1: VS-44HDx1 3G HD/SD-SDI 4x4 Matrix Switcher Front Panel

#	Feature	Function
1	IR Receiver	The LED illuminates when receiving signals from the infrared remote control transmitter
2	POWER Switch	Illuminated switch for turning the unit ON or OFF
3	INPUT SELECTOR (DUAL LINK) Buttons	Select the input to switch to the output (from 1 to 4). In the dual-link mode, select input 1 or 2 to switch dual-link 1 or 2 to the outputs Press IN buttons 1, 2 and 3 simultaneously, to reset the machine to its factory default values (see Section 5.6) The 7-segment display shows 1234 indicating that the operation mode is normal, and that the setups stored via the INPUT/OUTPUT buttons have been erased. Use to set the resolution when switching genlocked video signals (see Section 5.8)
4	OUTPUT SELECTOR (DUAL LINK) Buttons	Select the output to which the input is switched (from 1 to 4) In the dual-link mode, select output DUAL LINK 1 or DUAL LINK 2 to which the input is switched
5	STO (STORE) Button	Pressing STO followed by an INPUT / OUTPUT button stores the current setting
6	TAKE Button	Pressing TAKE toggles the mode between the CONFIRM mode and the AT ONCE mode (user confirmation per action is unnecessary). When in CONFIRM mode, the TAKE button implements a pending operation (See Section 6.2)
7	RCL (RECALL) Button	Pressing the RCL button and the corresponding INPUT / OUTPUT key recalls a setup from the non-volatile memory. After pressing the same memory location the second time, the settings take effect
8	ALL Button	Pressing ALL followed by an INPUT button, connects that input to all outputs When in Confirm mode, the TAKE button illuminates
9	OFF Button	An OFF-OUT combination disconnects that output from the inputs; an OFF-ALL combination disconnects all the outputs Press and hold (for more than 3 seconds) to toggle between the 4x4 switcher mode and the dual-link 2x2 switcher mode
10	LOCK Button	Disengages the front panel buttons
11	7-segment display	Displays the selected input switched to the output (marked above each input)

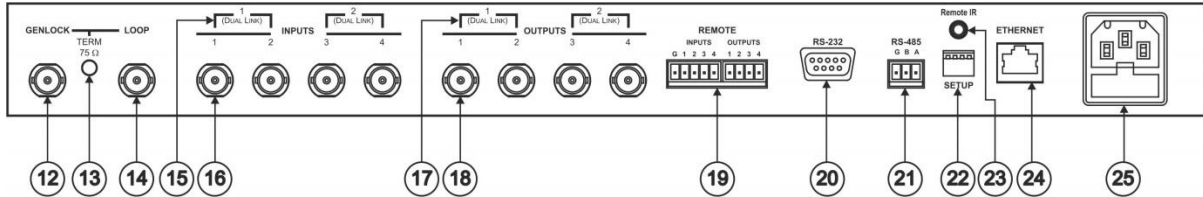

Figure 2: VS-44HDxI 3G HD/SD-SDI 4x4 Matrix Switcher Rear Panel

#	Feature	Function
12	GENLOCK BNC Connector	Connect to the genlock source
13	TERM 75Ω Button	Press to terminate the genlock source (75Ω) or release for looping
14	LOOP BNC Connector	Connect to the GENLOCK connector of the next unit in the line
15	DUAL LINK INPUT BNC Connectors	In the dual-link mode, connect the source to inputs 1 and 2 and/or inputs 3 and 4 (DUAL LINK 1 and/or DUAL LINK 2)
16	INPUT BNC Connectors	Connect to the serial digital video sources (from 1 to 4)
17	DUAL LINK OUTPUT BNC Connectors	In the dual-link mode, connect the acceptors to outputs 1 and 2 and/or outputs 3 and 4 (DUAL LINK 1 and/or DUAL LINK 2)
18	OUTPUT BNC Connectors	Connect to the serial digital video acceptors (from 1 to 4)
19	REMOTE Terminal Block Connector	Connect to contact closure switches (see Section 5.10)
20	RS-232 9-pin D-sub Port	Connects to the PC or the Remote Controller via a null-modem connection
21	RS-485 Detachable Terminal Block Port	Pin G is for the Ground connection; pins B (-) and A (+) are for RS-485
22	SETUP DIP-switches	DIP-switches for setup of the unit
23	REMOTE IR Opening	Connects to an external IR receiver unit for controlling the machine via an IR remote controller (instead of using the front panel IR receiver) (Covered by a cap. The 3.5mm connector at the end of the internal IR connection cable fits through this opening)
24	Ethernet Connector	Connects to the PC or other Serial Controller through computer networking
25	Power Connector with Fuse	AC connector enabling power supply to the unit

4 Installing in a Rack

This section provides instructions for rack mounting the unit.

Before installing in a rack, be sure that the environment is within the recommended range:

OPERATING TEMPERATURE:	0° to +40°C (32° to 104°F)
STORAGE TEMPERATURE:	-40° to +70°C (-40° to 158°F)
HUMIDITY:	10% to 90%, RHL non-condensing



CAUTION!

When installing on a 19" rack, avoid hazards by taking care that:

1. It is located within the recommended environmental conditions, as the operating ambient temperature of a closed or multi unit rack assembly may exceed the room ambient temperature.
2. Once rack mounted, enough air will still flow around the machine.
3. The machine is placed straight in the correct horizontal position.
4. You do not overload the circuit(s). When connecting the machine to the supply circuit, overloading the circuits might have a detrimental effect on overcurrent protection and supply wiring. Refer to the appropriate nameplate ratings for information. For example, for fuse replacement, see the value printed on the product label.
5. The machine is earthed (grounded) in a reliable way and is connected only to an electricity socket with grounding. Pay particular attention to situations where electricity is supplied indirectly (when the power cord is not plugged directly into the socket in the wall), for example, when using an extension cable or a power strip, and that you use only the power cord that is supplied with the machine.

To rack-mount a machine:

1. Attach both ear brackets to the machine. To do so, remove the screws from each side of the machine (3 on each side), and replace those screws through the ear brackets.

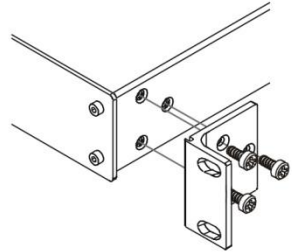

2. Place the ears of the machine against the rack rails, and insert the proper screws (not provided) through each of the four holes in the rack ears.

Note:

- In some models, the front panel may feature built-in rack ears
- Detachable rack ears can be removed for desktop use
- Always mount the machine in the rack before you attach any cables or connect the machine to the power
- If you are using a Kramer rack adapter kit (for a machine that is not 19"), see the Rack Adapters user manual for installation instructions available from our Web site

4.1 Using the IR Transmitter

You can use the **RC-IR3** IR transmitter to control the machine via the built-in IR receiver on the front panel or, instead, via an optional external IR receiver (Model: C-A35M/IRR-50). The external IR receiver can be located up to 15 meters away from the machine. This distance can be extended to up to 60 meters when used with three extension cables (Model: C-A35M/A35F-50).

Before using the external IR receiver, be sure to arrange for your Kramer dealer to insert the internal IR connection cable (P/N: 505-70434010-S) with the 3.5mm connector that fits into the REMOTE IR opening on the rear panel. Connect the external IR receiver to the REMOTE IR 3.5mm connector.

5 Connecting the VS-44HDxI



Always switch off the power to each device before connecting it to your **VS-44HDxI**. After connecting your **VS-44HDxI**, connect its power and then switch on the power to each device.

This section describes how to connect the **VS-44HDxI**.

- To connect the **VS-44HDxI** in the single-link mode, see [Section 5.1](#)
- To connect the **VS-44HDxI** in the dual-link mode, see [Section 5.2](#)

5.1 Connecting the VS-44HDxI in Single-Link Mode

You can use your **VS-44HDxI** to switch any of the four SDI inputs to any or all of the four SDI outputs, as illustrated in [Figure 3](#).

To connect the **VS-44HDxI** as a 4x4 matrix switcher, do the following:

1. Connect up to four SDI sources to the INPUT BNC connectors (for example, an HD/SD-SDI camera to input 1 and a 3G HD video server to input 4).
2. Connect the OUTPUT BNC connectors to up to four SDI acceptors (for example, output 1 to a Preview display, and output 4 to an HD-SDI mixer).
3. Set the DIP-switches (see [Section 5.4](#)).
4. If required, connect:
 - A genlock source to the GENLOCK BNC connector
Not illustrated in [Figure 3](#).
 - The LOOP BNC connector to the GENLOCK connector of the next unit in the line, and release the TERM button for looping
Pushed in terminates the input. Release when the input extends to another unit.
5. Connect a PC and/or controller (if required), to the:
 - RS-232 port (see [Section 5.5](#)), and/or
 - RS-485 port (see [Section 5.6](#)), and/or

- Ethernet connector (see [Section 5.9](#))
6. If required, connect a remote contact closure switch (refer to [Section 5.10](#)).
 7. Connect the power cord.
 8. If required, exit the dual-link mode (see [Section 5.3](#)).

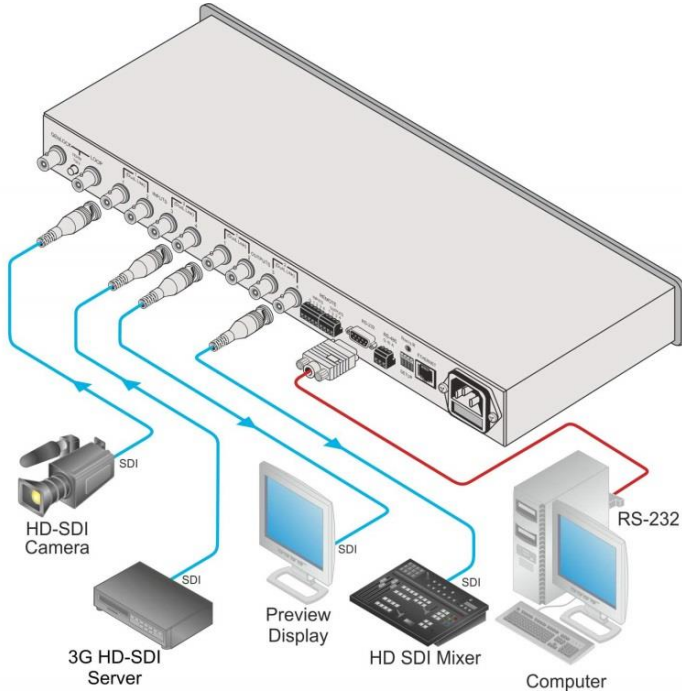

Figure 3: Connecting the VS-44HDxI 3G HD/SD-SDI 4x4 Matrix Switcher

5.2 Connecting the VS-44HDxI in the Dual-Link Mode

You can use your **VS-44HDxI** in the dual-link mode to switch any of the two dual-link SDI inputs to any or all of the two dual-link SDI outputs, as the illustration in [Figure 4](#) shows.

To connect the **VS-44HDxI** in the dual-link mode, do the following:

1. Connect one or both of the SDI sources to the INPUT DUAL LINK BNC connectors. For example, a dual-link HD/SD SDI camera to DUAL LINK 1 (inputs 1 and 2) and a dual-link 3G HD video server to DUAL LINK 2 (inputs 3 and 4).
2. Connect the SDI OUTPUT BNC connectors to one or both SDI acceptors. For example, OUTPUT DUAL LINK 1 (outputs 1 and 2) to a dual-link preview display, and OUTPUT DUAL LINK 2 (outputs 3 and 4) to a dual-link HD SDI mixer.
3. Set the DIP-switches (see [Section 5.3](#)).
4. If required, connect (not shown in [Figure 3](#)):
 - A genlock source to the GENLOCK BNC connector
 - The LOOP BNC connector to the GENLOCK connector of the next unit in the line, and release the TERM button for looping
Pushed in terminates the input. Release when the input extends to another unit.
5. Connect a PC and/or controller (if required), to the:
 - RS-232 port (see [Section 5.5](#)), and/or
 - RS-485 port (see [Section 5.6](#)), and/or
 - Ethernet connector (see [Section 5.9](#))
6. If required, connect a remote contact closure switch (see [Section 5.10](#)).
7. Connect the power cord.
8. Set the machine to the dual-link mode (see [Section 5.3](#)).

5.4 Setting the DIP-Switches

By default, all the DIP-switches are set to OFF. [Figure 5](#) illustrates the **VS-44HDxI** DIP-switches:



Figure 5: VS-44HDxI SETUP DIP-switches

5.4.1 Setting the Machine # DIP-Switches

The Machine # determines the position of a **VS-44HDxI** unit, specifying which **VS-44HDxI** unit is being controlled when several **VS-44HDxI** units connect to a PC or serial controller. Set the Machine # on a **VS-44HDxI** unit via SETUP DIPS 1, 2, 3 and 4, according to the following table.

When using a standalone **VS-44HDxI** unit, set the Machine # to 1. When connecting more than one **VS-44HDxI** unit, set the first machine (the Master) that is closest to the PC, as Machine # 1 (DIP-switches are set to OFF).

Mach. #	DIP 1	DIP 2	DIP 3	DIP 4
1 (default)	OFF	OFF	OFF	OFF
2	OFF	OFF	OFF	ON
3	OFF	OFF	ON	OFF
4	OFF	OFF	ON	ON
5	OFF	ON	OFF	OFF
6	OFF	ON	OFF	ON
7	OFF	ON	ON	OFF
8	OFF	ON	ON	ON

5.5 Connecting the RS-232 Port

You can connect to the unit via a crossed RS-232 connection, using for example, a PC. A crossed cable or null-modem is required as shown in method A and B respectively. If a shielded cable is used, connect the shield to pin 5.

Method A (Figure 6)—Connect the RS-232 9-pin D-sub port on the unit via a crossed cable (only pin 2 to pin 3, pin 3 to pin 2, and pin 5 to pin 5 need be connected) to the RS-232 9-pin D-sub port on the PC.

Note: There is no need to connect any other pins.

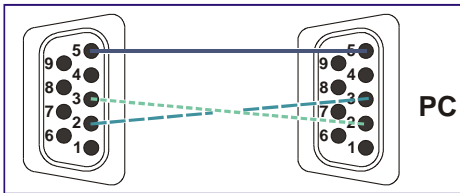

Figure 6: Crossed Cable RS-232 Connection

Hardware flow control is not required for this unit. In the rare case where a controller requires hardware flow control, short pin 1 to 7 and 8, and pin 4 to 6 on the controller side.

Method B (Figure 7)—Connect the RS-232 9-pin D-sub port on the unit via a straight (flat) cable to the null-modem adapter, and connect the null-modem adapter to the RS-232 9-pin D-sub port on the PC. The straight cable usually contains all nine wires for a full connection of the D-sub connector. Because the null-modem adapter (which already includes the flow control jumpering described in Method A above) only requires pins 2, 3 and 5 to be connected, you are free to decide whether to connect only these 3 pins or all 9 pins.

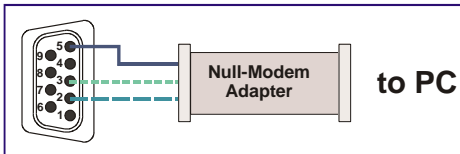

Figure 7: Straight Cable RS-232 Connection with a Null Modem Adapter

5.6 Connecting a PC or Controller to the RS-485 Port

You can operate the **VS-44HDxI** via the RS-485 port from a distance of up to 1200m (3900ft) using any device equipped with an RS-485 port (for example, a PC). For successful communication, you must set the RS-485 machine number and bus termination.

To connect a device with a RS-485 port to the **VS-44HDxI**:

- Connect the A (+) pin on the RS-485 port of the PC to the A (+) pin on the RS-485 port on the rear panel of the **VS-44HDxI**
- Connect the B (-) pin on the RS-485 port of the PC to the B (-) pin on the RS-485 port on the rear panel of the **VS-44HDxI**
- Connect the G pin on the RS-485 port of the PC to the G pin on the RS-485 port on the rear panel of the **VS-44HDxI**

5.7 Performing a Factory Reset

Press and hold the input buttons 1, 2 and 3 simultaneously for 3 seconds until the three buttons flash to reset the machine to its default values.

5.8 Switching Genlocked Video Signals

The genlock feature lets you switch genlocked video signals according to timing of the GENLOCK reference input.

According to SMPTE RP-168. The sources must be genlocked to the GENLOCK input in order to switch cleanly.

- Connect the GENLOCK cable.

If the HD input signal that is connected is one of the following, it is necessary to set it up as follows:

The unit automatically detects when SD-SDI inputs are used.

- 1080i@60Hz: press and hold INPUT 1 button for 3 seconds. The button flashes to indicate that the set up was completed
If a change is made to the resolution or refresh rate. The button does not flash if the new timing is the same as that previously selected.
- 1080i@50Hz or 720p@50Hz: press and hold INPUT 2 button for 3 seconds. The button flashes to indicate that the set up was completed

- 720p@60Hz: press and hold INPUT 3 button for 3 seconds.
The button flashes to indicate that the set up was completed

When turning the machine ON, the appropriate button flashes to indicate the latest setup (last setup is saved).

5.9 Operating via Ethernet

You can connect to the **product** via Ethernet using either of the following methods:

- Directly to the PC using a crossover cable (see [Section 5.9.1](#))
- Via a network hub, switch, or router, using a straight-through cable (see [Section 5.9.2](#))

Note: If you want to connect via a router and your IT system is based on IPv6, speak to your IT department for specific installation instructions.

5.9.1 Connecting the Ethernet Port Directly to a PC

You can connect the Ethernet port of the **VS-44HDxI** directly to the Ethernet port on your PC using a crossover cable with RJ-45 connectors.



This type of connection is recommended for identifying the **VS-44HDxI** with the factory configured default IP address.

After connecting the **VS-44HDxI** to the Ethernet port, configure your PC as follows:

1. Click **Start > Control Panel > Network and Sharing Center**.
2. Click **Change Adapter Settings**.
3. Highlight the network adapter you want to use to connect to the device and click **Change settings of this connection**.

The Local Area Connection Properties window for the selected network adapter appears as shown in [Figure 8](#).

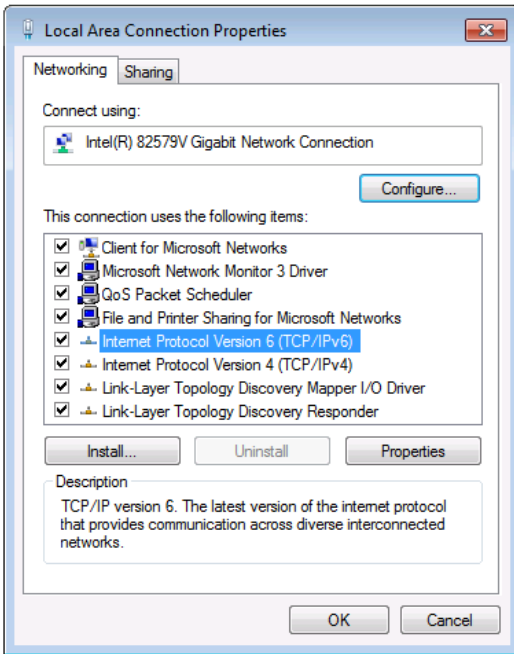

Figure 8: Local Area Connection Properties Window

4. Highlight either **Internet Protocol Version 6 (TCP/IPv6)** or **Internet Protocol Version 4 (TCP/IPv4)** depending on the requirements of your IT system.
5. Click **Properties**.

The Internet Protocol Properties window relevant to your IT system appears as shown in [Figure 9](#) or [Figure 10](#).

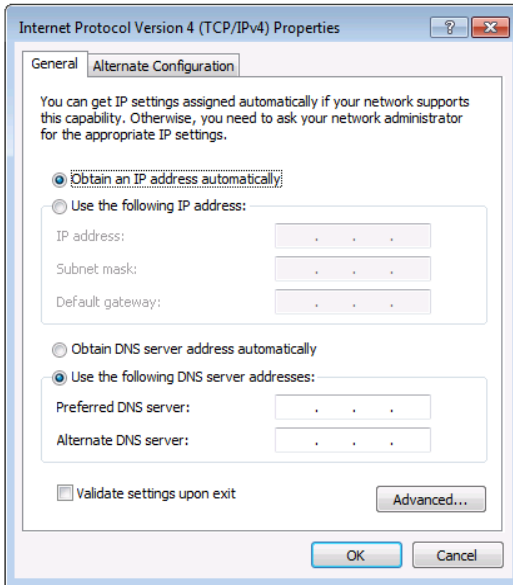

Figure 9: Internet Protocol Version 4 Properties Window

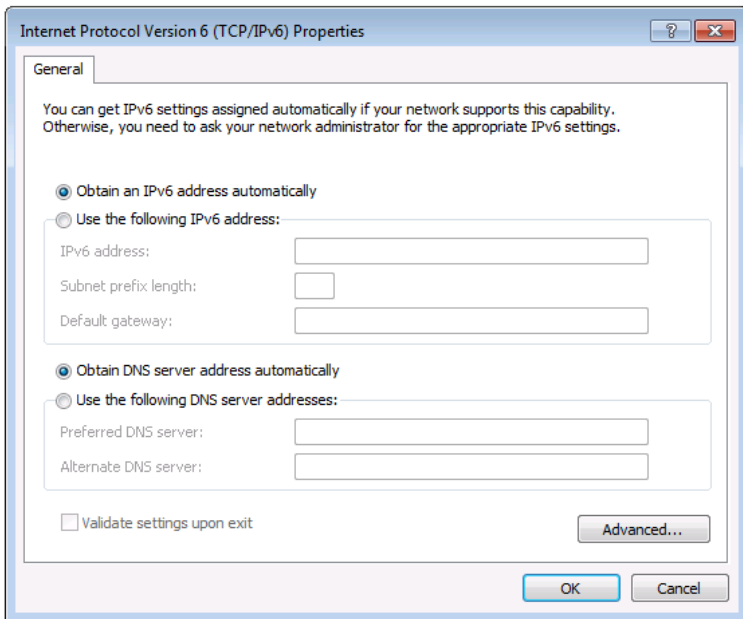

Figure 10: Internet Protocol Version 6 Properties Window

6. Select **Use the following IP Address** for static IP addressing and fill in the details as shown in [Figure 11](#).

For TCP/IPv4 you can use any IP address in the range 192.168.1.1 to 192.168.1.255 (excluding 192.168.1.39) that is provided by your IT department.

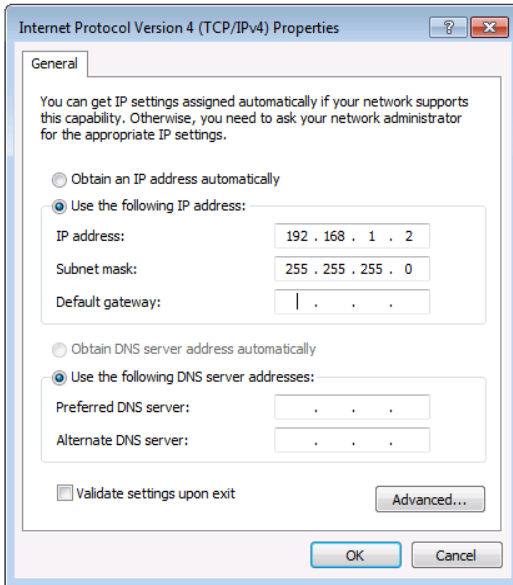

Figure 11: Internet Protocol Properties Window

7. Click **OK**.
8. Click **Close**.

5.9.2 Connecting the Ethernet Port via a Network Hub or Switch

You can connect the Ethernet port of the **VS-44HDxl** to the Ethernet port on a network hub or using a straight-through cable with RJ-45 connectors.

5.9.3 Control Configuration via the Ethernet Port

To control several units via Ethernet, connect the Master unit (Device 1) via the Ethernet port to the Ethernet port of your PC. Use your PC provide initial configuration of the settings (see [Section 5.9](#)).

5.10 Controlling via the REMOTE Connector

You can force the routing of one of the four inputs to any of the four outputs by remote control. To do so, connect the appropriate REMOTE input terminal block connector pins to a contact closure switch.

In the dual-link mode, you can force the routing of any of the two inputs to any of the two outputs.

To route input 1 to output 4, as the example in [Figure 12](#) illustrates, momentarily touch, firstly, output # 4 to the ground, and then secondly, input # 1 to the ground.

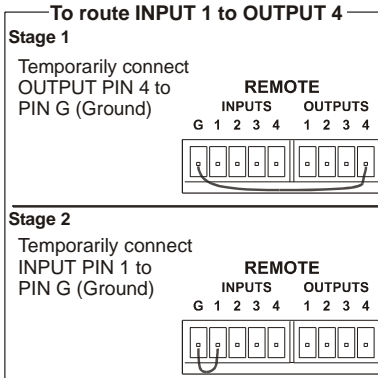

Figure 12: Using the REMOTE Connector



In the dual-link mode, only inputs and outputs 1 and 2 are used (as are the INPUT and OUTPUT selector buttons). Remote pins 3 and 4 and selector buttons 3 and 4 are not used

6 Operating the VS-44HDxI

You can operate your **VS-44HDxI** via:

- The front panel buttons
- RS-232/RS-485 serial commands transmitted by a PC, touch screen system, or other serial controller
- The Kramer infrared remote control transmitter
- The infrared remote extension cable transmitter
- The Ethernet

6.1 Switching Combinations

[Section 6.1.1](#) describes how to switch OUT-IN combinations and [Section 6.1.2](#) how to switch OUT-IN combinations in the dual-link mode.

Note that:

- The OUTPUT button color changes during routing according to the input button color: green (for standard definition) or blue (for high definition)
- If an OUTPUT button is not selected, that button does not illuminate
- If a source is connected to an INPUT, that INPUT button illuminates

6.1.1 Switching OUT-IN Combinations

To switch an input to an output, via the front panel buttons, in the AT ONCE mode (see [Section 6.2](#)), do the following:

For details of how to route an input to an output using the REMOTE connector, see [Section 5.10](#).

1. Press an OUTPUT button (either 1, 2, 3, 4 or ALL).
The selected OUTPUT button illuminates brightly, as does the 7-segment display.
2. For immediate switching, press an INPUT button (either 1, 2, 3, 4 or OFF).
The selected input switches to the selected output, and that input button

illuminates brightly. The digits displayed in the 7-segment display change as appropriate.

6.1.2 Switching OUT-IN Combinations in the Dual-Link Mode

To switch an input to an output in the dual-link mode, via the front panel buttons, in the AT ONCE mode (see [Section 6.2](#)), do the following:

1. Press an OUTPUT button (either 1, 2 or ALL).
The selected OUTPUT button illuminates brightly, as does the 7-segment display.
2. Press an INPUT button (either 1, 2 or OFF).
The selected input switches to the selected output, and that input button illuminates brightly. The digits displayed in the 7-segment display change as appropriate.

6.2 Confirming Settings

Choose to work in the AT ONCE or the CONFIRM mode. When the **VS-44HDxI** operates in the AT ONCE mode, pressing an OUT-IN combination implements the switch immediately. In the CONFIRM mode, the TAKE button must be pressed to authorize the switch.

In the AT ONCE mode, you save time as execution is immediate and actions require no user confirmation. However, no protection is offered against changing an action in error.

In the CONFIRM mode:

- You can key-in several actions and then confirm them by pressing the “TAKE” button to simultaneously activate the multiple switches
- Every action requires user confirmation, protecting against erroneous switching
- Execution is delayed until the user confirms the action

Note that after ten seconds the **VS-44HDxI** goes to standby mode and the buttons and the 7-segment display illuminates less brightly.

6.2.1 Toggling between the AT ONCE and CONFIRM Modes

To toggle between the AT ONCE and CONFIRM modes, do the following:

1. Press the dim TAKE button to toggle from the AT ONCE mode (in which the TAKE button is dim) to the CONFIRM mode (in which the TAKE button illuminates).
Actions now require user confirmation and the TAKE button illuminates.
2. Press the illuminated TAKE button to toggle from the CONFIRM mode back to the AT ONCE mode.
Actions no longer require user confirmation and the TAKE button no longer illuminates.

6.2.2 Confirming a Switching Action

To confirm a switching action (in CONFIRM mode where the TAKE button is illuminated), do the following:

When operating the machine in the CONFIRM mode, the remote RS-232 control is disabled.

1. Press an OUT-IN combination.
The 7-segment display flashes (the timeout lasts for 10 seconds).
2. Press the TAKE button to confirm the action.
The 7-segment display no longer flashes. The TAKE button illuminates.

To confirm several actions (in CONFIRM mode), do the following:

1. Press each OUT-IN combination in sequence.
The 7-segment display flashes.
2. Press the TAKE button to confirm all the actions.
The 7-segment display no longer flashes. The TAKE button illuminates.

6.3 Storing/Recalling Input/Output Configurations

You can store and recall up to eight setup configurations using the four INPUT buttons and the four OUTPUT buttons. The setup also includes the working mode.

6.3.1 Storing an Input/Output Configuration

To store the current status in memory, do the following:

1. Set the working mode, see Section 5.3.
2. Press the STO button.
The STO button illuminates.
3. Press one of the 8 INPUT / OUTPUT buttons (this is the setup # in which the current status is stored).
The selected INPUT / OUTPUT button illuminates in blue. The memory stores the data at that reference.



To confirm the setup, press the INPUT/OUTPUT button again.
To cancel the setup, press the STO button once again.

6.3.2 Recalling an Input/Output Configuration

To recall an input/output configuration, do the following:

1. Press the RCL button.
The RCL button illuminates.
2. Press the appropriate INPUT / OUTPUT button (the button # corresponding to the setup #). That setup configuration flashes in the 7-segment display .
The memory recalls the stored data from that reference.
After pressing the same memory location the second time, the settings take effect.



To cancel this action, press the RCL button once again.

6.4 Locking the Front Panel

To prevent changing the settings accidentally or tampering with the unit via the front panel buttons, lock your **VS-44HDxI**. Unlocking releases the protection mechanism.

Even though the front panel is locked you can still operate via RS-232 or RS-485, as well as via the Kramer IR remote control transmitter.

To lock the **VS-44HDxI**:

- Press the LOCK button for three seconds, until the LOCK button is illuminated. The front panel is locked. Pressing a button has no effect

To unlock the **VS-44HDxI**:

- Press the illuminated LOCK button until the LOCK button is no longer illuminated. The front panel unlocks

7 Technical Specifications

INPUTS:	4 SMPTE-259M / 292M / 424M / (372M for dual-link HD-SDI signals) serial video, 75 ohms on BNC connectors 1 GENLOCK 75Ω / Hi-Z on a BNC connector, hi-level or tri-level sync
OUTPUTS:	4 equalized and reclocked SMPTE-259M, 292M (372M for dual-link HD-SDI signals) outputs 75 ohms on BNC connectors 1 Looped GENLOCK 75Ω / Hi-Z on a BNC connector
MAX. OUTPUT LEVEL:	800mVpp / 75 ohms
DATA RATE:	Up to 2.97Gbps
CONTROLS:	Front-panel, RS-232; RS-485, Ethernet, infra-red remote, contact closure, and panel lock
POWER CONSUMPTION:	100-240VAC, 50/60Hz 22VA
OPERATING TEMPERATURE:	0° to +40°C (32° to 104°F)
STORAGE TEMPERATURE:	-40° to +70°C (-40° to 158°F)
HUMIDITY:	10% to 90%, RHL non-condensing
DIMENSIONS:	19" x 7" x 1U (W, D, H) rack mountable
WEIGHT:	2.6kg (5.7lbs) approx.
ACCESSORIES:	Power cord, null-modem adapter
OPTIONS:	C-A35M/IRR-50, external remote IR receiver cable
Specifications are subject to change without notice at http://www.kramerelectronics.com	

8 Table of Hex Codes for Serial Communication

The following table lists the hex values for a single machine (*MACHINE # 1*):

IN/OUT 1	IN/OUT 2	IN/OUT 3	IN/OUT 4
01	01	01	01
81	82	83	84
81	81	81	81
81	81	81	81

9 Protocol 2000

This RS-232/RS-485 communication protocol uses four bytes of information as defined below.

For RS-232, a null-modem connection between the machine and controller is used. The default data rate is 9600 baud, with no parity, 8 data bits and 1 stop bit.

Note: Compatibility with Kramer's Protocol 2000 does not mean that a machine uses all of the commands below. Each machine uses a sub-set of Protocol 2000, according to its needs.

9.1 Syntax

MSB								LSB
1st Byte		DESTINATION			INSTRUCTION			
0	D	N5	N4	N3	N2	N1	N0	
7	6	5	4	3	2	1	0	
2nd Byte		INPUT						
1	I6	I5	I4	I3	I2	I1	I0	
7	6	5	4	3	2	1	0	
3rd Byte		OUTPUT						
1	O6	O5	O4	O3	O2	O1	O0	
7	6	5	4	3	2	1	0	
4th Byte		MACHINE NUMBER						
1	OVR	X	M4	M3	M2	M1	M0	
7	6	5	4	3	2	1	0	

1st Byte: Bit 7 – Defined as 0
 D – DESTINATION:
 0 – Sends information to the switchers (from the PC)
 1 – Sends information to the PC (from the switcher)
 N5...N0 – INSTRUCTION

The 6-bit INSTRUCTION defines the function performed by the switcher(s). If a function is performed using the machine's keyboard, these bits are set with the INSTRUCTION NO. performed. The instruction codes are defined according to the table below (INSTRUCTION NO. is the value set in N5...N0).

2nd Byte: Bit 7 – Defined as 1
 I6...I0 – INPUT

When switching (i.e. instruction codes 1 and 2), the 7-bit INPUT is set as the input number to be switched. If switching is done using the machine's front panel, these bits are set with the INPUT NUMBER switched. For other operations, these bits are defined according to the table.

3rd Byte: Bit 7 – Defined as 1
 O6...O0 – OUTPUT

When switching (i.e. instruction codes 1 and 2), the 7-bit OUTPUT is set as the output number to be switched. If switching is done using the machine's front panel, these bits are set with the OUTPUT NUMBER switched. For other operations, these bits are defined according to the table.

4th Byte: Bit 7 – Defined as 1
 Bit 5 – Don't care
 OVR – Machine number override
 M4...M0 – MACHINE NUMBER

This byte is used to address machines in a system by their machine numbers. When several machines are controlled from a single serial port, they are usually configured together and each machine has an individual machine number. If the OVR bit is set, then all machine numbers accept (implement) the command and the addressed machine replies. When a single machine is controlled over the serial port, always set M4...M0 to 1, and make sure that the machine itself is configured as MACHINE NUMBER = 1.

9.2 Instruction Codes

All the values in the table are decimal, unless otherwise stated

Instruction Codes for Protocol 2000				
Instruction		Definition for Specific Instruction		Notes
#	Description	Input	Output	
0	RESET VIDEO	0	0	1
1	SWITCH VIDEO	Set equal to video input that is switched (0 = disconnect)	Set equal to video output that is switched (0 = to all the outputs)	2, 15
3	STORE VIDEO STATUS	Set as SETUP #	To store To delete	2, 3, 15
4	RECALL VIDEO STATUS	Set as SETUP #	0	2, 3, 15
5	REQUEST STATUS OF A VIDEO OUTPUT	Set as SETUP #	Equal to output number whose status is required	4, 3
10	REQUEST VIS SETTING	Set as SETUP #, or set to 126 or 127 to request if machine has this function	0 – VIS source 1 – Input # or output # of source 2 – Vertical sync freq (Hz)	3, 4, 6, 7
15	REQUEST WHETHER SETUP IS DEFINED / VALID INPUT IS DETECTED	SETUP # or Input # or Output #	0 – For checking if setup is defined 1 – For checking if input is valid 2 – For checking if output is valid 3 – For checking if EDID output is valid	8
16	ERROR / BUSY	For invalid / valid input (i.e. OUTPUT byte = 4 or OUTPUT byte = 5), this byte is set as the input #; For invalid / valid output (i.e. OUTPUT byte=7 or OUTPUT byte=8), this byte is set as the output#	0 – Error 1 – Invalid instruction 2 – Out of range 3 – Machine busy 4 – Invalid input 5 – Valid input 6 – RX buffer overflow 7 – Invalid output 8 – Valid output 9 – Valid EDID	9, 25
30	LOCK FRONT PANEL	0 – Unlock panel 1 – Lock panel	0	2
31	REQUEST WHETHER PANEL IS LOCKED	0	0	16
61	IDENTIFY MACHINE	1 – Video machine name 2 – Audio machine name 3 – Video software version 4 – Audio software version 5 – RS-422 controller name 6 – RS-422 controller version 7 – Remote control name 8 – Remote software version 9 – Protocol 2000 revision 10 – Control data machine name 11 – Control data software version	For names: 0 – Request first 4 digits 1 – Request first suffix 2 – Request second suffix 3 – Request third suffix 10 – Request first prefix 11 – Request second prefix 12 – Request third prefix For versions: 0 – main board or the number of external board	13
62	DEFINE MACHINE	1 – Number of inputs 2 – Number of outputs 3 – Number of setups	1 – For video 2 – For audio 3 – For SDI 4 – For remote panel 5 – For RS-422 controller 6 – For control data	14

NOTES on the above table:

NOTE 1 – When the master switcher is reset, (e.g. when it is turned on), the reset code is sent to the PC. If this code is sent to a switcher, it resets according to the present power-down settings.

NOTE 2 – These are bi-directional definitions. If the switcher receives the code, it performs the instruction. If the instruction is performed (due to a keystroke operation on the front panel), then these codes are sent.

For example, if the PC sends HEX code:

01 85 88 83

then the switcher (machine 3) switches input 5 to output 8.

If the user switches input 1 to output 7 using the front panel buttons, the switcher sends HEX code:

41 81 87 83

to the PC.

When the PC sends one of the commands in this group to the switcher, if the instruction is valid, the switcher replies by sending the same four bytes to the PC that it received (except for the first byte, where the DESTINATION bit is set high).

NOTE 3 – SETUP # 0 is the present setting, SETUP # 1 and higher are the settings saved in the switcher's memory, (i.e. those used for Store and Recall).

NOTE 4 – The reply to a REQUEST instruction is as follows: the same instruction and INPUT codes that were sent are returned, and the OUTPUT is assigned the value of the requested parameter. The replies to instructions 10 and 11 are according to the definitions in instructions 7 and 8 respectively.

For example, if the present status of machine number 5 is breakaway setting, then the reply to HEX code:

0B 80 80 85

is HEX code:

4B 80 81 85.

NOTE 6 – If INPUT is set to 127 for these instructions, and if the function is defined on this machine, it replies with OUTPUT=1. If the function is not defined, then the machine replies with OUTPUT=0, or with an error (invalid instruction code).

If the INPUT is set to 126 for these instructions, then, if possible, the machine returns the current setting of this function, even in the case that the function is not defined.

For example, for a video switcher that always switches during the VIS of input #1 (and its VIS setting cannot be programmed otherwise), the reply to the HEX code:

0A FE 80 81 (i.e. request VIS setting, with INPUT set as 126_{dec})

is HEX code:

4A FE 81 81 (i.e. VIS setting = 1, defined as VIS from input #1).

NOTE 7 – Setting OUTPUT to 0 returns the VIS source setting as defined in instruction #7. Setting to 1 returns the input # or output # of the sync source (in the case where the VIS source is set as 6 or as 7 in instruction #7). Setting to 2 returns the vertical sync frequency (0 for no input sync, 50 for PAL, 60 for NTSC, 127 for error).

NOTE 8 – The reply is as in NOTE 4 above, except that the OUTPUT is assigned with the value 0 if the setup is not defined / no valid input is detected; or 1 if it is defined / valid input is detected.

NOTE 9 - An error code is returned to the PC if an invalid instruction code was sent to the switcher, or if a parameter associated with the instruction is out of range (e.g. trying to save to a setup greater than the highest one, or trying to switch an input or output greater than the highest one defined). This code is also returned to the PC if an RS-232 instruction is sent while the machine is being programmed from the front panel. Reception of this code by the switcher is not valid.

NOTE 13 – This is a request to identify the switcher/s in the system. If the OUTPUT is set as 0, and the INPUT is set as 1, 2, 5 or 7, the machine sends its name. The reply is the decimal value of the INPUT and OUTPUT.

For example, for a 2216, the reply to the request to send the audio machine name is HEX code:

7D 96 90 81 (i.e. 128_{dec}+ 22_{dec} for 2nd byte, and 128_{dec}+ 16_{dec} for 3rd byte).

If the request for identification is sent with the INPUT set as 3 or 4, the appropriate machine sends its software version number. Again, the reply would be the decimal value of the INPUT and OUTPUT - the INPUT representing the number in front of the decimal point, and the OUTPUT representing the number after it.

For example, for version 3.5, the reply to the request to send the version number would be HEX code:

7D 83 85 81 (i.e. 128_{dec}+ 3_{dec} for 2nd byte, 128_{dec}+ 5_{dec} for 3rd byte).

If the OUTPUT is set as 1, then the ASCII coding of the lettering following the machine's name is sent.

For example, for the VS-7588YC, the reply to the request to send the first suffix would be HEX code:

7D D9 C3 81 (i.e. 128_{dec}+ ASCII for "Y"; 128_{dec}+ ASCII for "C").

NOTE 14 – The number of inputs and outputs refers to the specific machine being addressed, *not* to the system.

For example, if six 16x16 matrices are configured to make a 48x32 system (48 inputs, 32 outputs), the reply to the HEX code:

3E 82 81 82 (i.e. request the number of outputs)

would be HEX code:

7E 82 90 82 (i.e. 16 outputs).

NOTE 15 – When the OVR bit (4th byte) is set, then the video commands have universal meaning.

For example, instruction 1 (SWITCH VIDEO) causes all units (including audio, data, etc.) to switch. Similarly, if a machine is in FOLLOW mode, it performs any video instruction.

NOTE 16 – The reply to the REQUEST WHETHER PANEL IS LOCKED is the same as in NOTE 4 above, except that OUTPUT is assigned with the value 0 if the panel is unlocked, or 1 if it is locked.

NOTE 25 – For units that detect the validity of the video inputs, instruction 16 is sent whenever the unit detects a change in the state of an input (in real-time).

For example, if input 3 is detected as invalid, the unit sends HEX code:

10 83 84 81

If input 7 is detected as valid, then the unit sends HEX code:

10 87 85 81.

LIMITED WARRANTY

The warranty obligations of Kramer Electronics for this product are limited to the terms set forth below:

What is Covered

This limited warranty covers defects in materials and workmanship in this product.

What is Not Covered

This limited warranty does not cover any damage, deterioration or malfunction resulting from any alteration, modification, improper or unreasonable use or maintenance, misuse, abuse, accident, neglect, exposure to excess moisture, fire, improper packing and shipping (such claims must be presented to the carrier), lightning, power surges, or other acts of nature. This limited warranty does not cover any damage, deterioration or malfunction resulting from the installation or removal of this product from any installation, any unauthorized tampering with this product, any repairs attempted by anyone unauthorized by Kramer Electronics to make such repairs, or any other cause which does not relate directly to a defect in materials and/or workmanship of this product. This limited warranty does not cover cartons, equipment enclosures, cables or accessories used in conjunction with this product.

Without limiting any other exclusion herein, Kramer Electronics does not warrant that the product covered hereby, including, without limitation, the technology and/or integrated circuit(s) included in the product, will not become obsolete or that such items are or will remain compatible with any other product or technology with which the product may be used.

How Long Does this Coverage Last

Seven years as of this printing; please check our Web site for the most current and accurate warranty information.

Who is Covered

Only the original purchaser of this product is covered under this limited warranty. This limited warranty is not transferable to subsequent purchasers or owners of this product.

What Kramer Electronics will do

Kramer Electronics will, at its sole option, provide one of the following three remedies to whatever extent it shall deem necessary to satisfy a proper claim under this limited warranty:

1. Elect to repair or facilitate the repair of any defective parts within a reasonable period of time, free of any charge for the necessary parts and labor to complete the repair and restore this product to its proper operating condition. Kramer Electronics will also pay the shipping costs necessary to return this product once the repair is complete.
2. Replace this product with a direct replacement or with a similar product deemed by Kramer Electronics to perform substantially the same function as the original product.
3. Issue a refund of the original purchase price less depreciation to be determined based on the age of the product at the time remedy is sought under this limited warranty.

What Kramer Electronics will not do Under This Limited Warranty

If this product is returned to Kramer Electronics or the authorized dealer from which it was purchased or any other party authorized to repair Kramer Electronics products, this product must be insured during shipment, with the insurance and shipping charges prepaid by you. If this product is returned uninsured, you assume all risks of loss or damage during shipment. Kramer Electronics will not be responsible for any costs related to the removal or re-installation of this product from or into any installation. Kramer Electronics will not be responsible for any costs related to any setting up this product, any adjustment of user controls or any programming required for a specific installation of this product.

How to Obtain a Remedy under this Limited Warranty

To obtain a remedy under this limited warranty, you must contact either the authorized Kramer Electronics reseller from whom you purchased this product or the Kramer Electronics office nearest you. For a list of authorized Kramer Electronics resellers and/or Kramer Electronics authorized service providers, please visit our web site at www.kramerelectronics.com or contact the Kramer Electronics office nearest you.

In order to pursue any remedy under this limited warranty, you must possess an original, dated receipt as proof of purchase from an authorized Kramer Electronics reseller. If this product is returned under this limited warranty, a return authorization number, obtained from Kramer Electronics, will be required. You may also be directed to an authorized reseller or a person authorized by Kramer Electronics to repair the product.

If it is decided that this product should be returned directly to Kramer Electronics, this product should be properly packed, preferably in the original carton, for shipping. Cartons not bearing a return authorization number will be refused.

Limitation on Liability

THE MAXIMUM LIABILITY OF KRAMER ELECTRONICS UNDER THIS LIMITED WARRANTY SHALL NOT EXCEED THE ACTUAL PURCHASE PRICE PAID FOR THE PRODUCT. TO THE MAXIMUM EXTENT PERMITTED BY LAW, KRAMER ELECTRONICS IS NOT RESPONSIBLE FOR DIRECT, SPECIAL, INCIDENTAL OR CONSEQUENTIAL DAMAGES RESULTING FROM ANY BREACH OF WARRANTY OR CONDITION, OR UNDER ANY OTHER LEGAL THEORY. Some countries, districts or states do not allow the exclusion or limitation of relief, special, incidental, consequential or indirect damages, or the limitation of liability to specified amounts, so the above limitations or exclusions may not apply to you.

Exclusive Remedy

TO THE MAXIMUM EXTENT PERMITTED BY LAW, THIS LIMITED WARRANTY AND THE REMEDIES SET FORTH ABOVE ARE EXCLUSIVE AND IN LIEU OF ALL OTHER WARRANTIES, REMEDIES AND CONDITIONS, WHETHER ORAL OR WRITTEN, EXPRESS OR IMPLIED. TO THE MAXIMUM EXTENT PERMITTED BY LAW, KRAMER ELECTRONICS SPECIFICALLY DISCLAIMS ANY AND ALL IMPLIED WARRANTIES, INCLUDING, WITHOUT LIMITATION, WARRANTIES OF MERCHANTABILITY AND FITNESS FOR A PARTICULAR PURPOSE. IF KRAMER ELECTRONICS CANNOT LAWFULLY DISCLAIM OR EXCLUDE IMPLIED WARRANTIES UNDER APPLICABLE LAW, THEN ALL IMPLIED WARRANTIES COVERING THIS PRODUCT, INCLUDING WARRANTIES OF MERCHANTABILITY AND FITNESS FOR A PARTICULAR PURPOSE, SHALL APPLY TO THIS PRODUCT AS PROVIDED UNDER APPLICABLE LAW.

IF ANY PRODUCT TO WHICH THIS LIMITED WARRANTY APPLIES IS A "CONSUMER PRODUCT" UNDER THE MAGNUSON-MOSS WARRANTY ACT (15 U.S.C.A. §2301, ET SEQ.) OR OTHER APPLICABLE LAW, THE FOREGOING DISCLAIMER OF IMPLIED WARRANTIES SHALL NOT APPLY TO YOU, AND ALL IMPLIED WARRANTIES ON THIS PRODUCT, INCLUDING WARRANTIES OF MERCHANTABILITY AND FITNESS FOR THE PARTICULAR PURPOSE, SHALL APPLY AS PROVIDED UNDER APPLICABLE LAW.

Other Conditions

This limited warranty gives you specific legal rights, and you may have other rights which vary from country to country or state to state.

This limited warranty is void if (i) the label bearing the serial number of this product has been removed or defaced, (ii) the product is not distributed by Kramer Electronics or (iii) this product is not purchased from an authorized Kramer Electronics reseller. If you are unsure whether a reseller is an authorized Kramer Electronics reseller, please visit our Web site at www.kramerelectronics.com or contact a Kramer Electronics office from the list at the end of this document.

Your rights under this limited warranty are not diminished if you do not complete and return the product registration form or complete and submit the online product registration form. Kramer Electronics thanks you for purchasing a Kramer Electronics product. We hope it will give you years of satisfaction.



For the latest information on our products and a list of Kramer distributors, visit our Web site where updates to this user manual may be found.

We welcome your questions, comments, and feedback.

Web site: www.kramerelectronics.com

E-mail: info@kramerel.com

CE



SAFETY WARNING

Disconnect the unit from the power supply before opening and servicing



P/N: 2900-000476



Rev: 4