

# INSTALLATION and STARTUP GUIDE

## SPN Mixers Digital Matrix Processors



**This manual covers the following models:**

- SPN2412**
- SPN1624**
- SPN1612**
- SPN812**

**See  
Quick Start  
Essential Settings  
on page 6**

**Visit the Lectrosonics Support web site:**

[www.lectrosonics.com/Support/](http://www.lectrosonics.com/Support/)

Also link from the home page: [www.lectrosonics.com](http://www.lectrosonics.com)

Fill in for your records:

Serial Number:

Purchase Date:





# Important Safety Instructions



This symbol, wherever it appears, alerts you to the presence of uninsulated dangerous voltage inside the enclosure -- voltage that may be sufficient to constitute a risk of shock.



This symbol, wherever it appears, alerts you to important operating and maintenance instructions in the accompanying literature. Please read the manual.

When using your telephone equipment, basic safety precautions should always be followed to reduce the risk of fire, electric shock and injury to persons, including the following:

- 1) Read these instructions.
- 2) Keep these instructions.
- 3) Heed all warnings.
- 4) Follow all instructions.
- 5) Do not use this apparatus near water.
- 6) Clean only with a dry cloth.
- 7) Do not block any ventilation openings. Install in accordance with the manufacturer's instructions.
- 8) Do not install near any heat sources such as radiators, heat registers, stoves, or other apparatus (including amplifiers) that produce heat.
- 9) Do not defeat the safety purpose of the polarized or grounding-type plug. A polarized plug has two blades with one wider than the other. A grounding type plug has two blades and third grounding prong. The wider blade or the third prong are provided for your safety. If the provided plug does not fit into your outlet, consult an electrician for replacement of the obsolete outlet.
- 10) Protect the power cord from being walked on or pinched particularly at plugs, convenience receptacles, and the point where they exit from the apparatus.
- 11) Only use attachments/accessories specified by the manufacturer.
- 12) Use only with the cart, stand, tripod, bracket, or table specified by the manufacturer, or sold with the apparatus. When a cart is used, use caution when moving the cart/apparatus combination to avoid injury from tip-over.
- 13) Unplug this apparatus during lightning storms or when unused for long periods of time.
- 14) Refer all servicing to qualified service personnel. Servicing is required when the apparatus has been damaged in any way, such as power-supply cord or plug is damaged, liquid has been spilled or objects have fallen into the apparatus, the apparatus has been exposed to rain or moisture, does not operate normally, or has been dropped.
- 15) **WARNING** -- TO REDUCE THE RISK OF FIRE OR ELECTRIC SHOCK, DO NOT EXPOSE THIS APPARATUS TO RAIN OR MOISTURE.
- 16) The AC mains plug, or appliance coupler shall be readily available to the operator as a means of power disconnection, if applicable.
- 17) Unit shall be connected to a MAINS socket outlet with a protective earthing connection.
- 18) Do not use this product near water for example, near a bathtub, washbowl, kitchen sink or laundry tub, in a wet basement or near a swimming pool.
- 19) Avoid using a telephone (other than a cordless type) during an electrical storm. There may be a remote risk of electric shock from lightning.
- 20) Do not use the telephone to report a gas leak in the vicinity of the leak.
- 21) Use only the power cord and batteries indicated in this manual. Do not dispose of batteries in a fire. They may explode. Check with local codes for possible special disposal instructions.
- 22) "CAUTION: To reduce the risk of fire, use only No. 26 AWG or larger (e.g., 24 AWG) UL Listed or CSA Certified Telecommunication Line Cord"



SAVE THESE INSTRUCTIONS

## FCC Part 15 Compliance

This device complies with Part 15 of the FCC Rules. Operation is subject to the following two conditions: (1) This device may not cause harmful interference, and (2) this device must accept any interference received, including interference that may cause undesired operation.

**CAUTION:** Changes or modifications not expressly approved by Lectrosonics, Inc. could void the user's authority to operate the equipment.

This equipment has been tested and found to comply with the limits for a Class A digital device, pursuant to Part 15 of the FCC Rules. These limits are designed to provide reasonable protection against harmful interference when the equipment is operated in a commercial environment. This equipment generates, uses, and can radiate radio frequency energy and, if not installed and used in accordance with the instruction manual, may cause harmful interference to radio communications. Operation of this equipment in a residential area is likely to cause harmful interference in which case the user will be required to correct the interference at this own expense.

# Table of Contents

<b>Important Safety Instructions</b> .....	<b>3</b>
<b>FCC Part 15 Compliance</b> .....	<b>5</b>
<b>Inspection of the Unit</b> .....	<b>5</b>
<b>Introduction</b> .....	<b>6</b>
<b>Quick Start Essential Settings</b> .....	<b>6</b>
<b>Front Panels</b> .....	<b>7</b>
<b>Rear Panels</b> .....	<b>8</b>
<b>Hardware Installation</b> .....	<b>10</b>
Installing the chassis into a rack .....	10
Cables .....	10
Audio Connectors .....	10
Audio Inputs – Unbalanced.....	10
Audio Outputs .....	11
Programmable Inputs.....	11
Programmable Outputs.....	11
Programmable Outputs (cont'd).....	12
ASPEN to PC RS-232 Port Wiring.....	12
Crestron/AMX RS-232 Port Wiring.....	12
Cabling Of Stacked Units .....	12
<b>Using the LCD</b> .....	<b>13</b>
<b>Software and Firmware Updates</b> .....	<b>16</b>
<b>Stacking Multiple Units</b> .....	<b>16</b>
<b>Creating an ASPEN Installer Disk</b> .....	<b>17</b>
<b>Firmware Update Procedure</b> .....	<b>17</b>
MCU Recovery from Interrupted Firmware Update Procedure.....	17
<b>Software/USB Driver Installation</b> .....	<b>18</b>
<b>Using the Software GUI</b>	
<b>for Minimum Setup</b> .....	<b>19</b>
<b>Stacking Multiple Units</b> .....	<b>20</b>
<b>Refer to the Help Files</b> .....	<b>20</b>
<b>Service and Repair</b> .....	<b>21</b>
Returning Units for Repair .....	21

## Inspection of the Unit

Compare the packing list enclosed with the unit with the original order. Inspect all items for damage. Immediately call 1-800-821-1121 to report any items that are missing or damaged. The sooner you notify us, the sooner you will get any needed replacement items shipped to your location.

## Introduction

The ASPEN digital matrix provides a maximum of 48 total outputs, but there is no limit to the number of inputs that can be added to a system by stacking multiple units. Input only units deliver outputs to the digital bus, so they are always used with a host mixer or conference unit to provide physical audio outputs.

ASPEN Series mixers are built around two “building block” board assemblies. One is an 8 in/12 out mixer, and the other is a 16 channel input only design. These two building blocks are combined in various configurations to create various processor models:

- SPN812 8 input, 12 output mixer, 1 RU
- SPN1612 16 input, 12 output mixer, 2 RU
- SPN1624 16 input, 24 output mixer, 2 RU
- SPN2412 24 input, 12 output mixer, 2 RU

Input only processor models include:

- SPN16i 16 channels, 1 RU
- SPN32i 32 channels, 2 RU

Other processor models include:

- SPNConference teleconference Interface, 1 RU
- SPNDNT Dante network interface, 1 RU\*

All models fully support the 48 outputs provided by the digital matrix, regardless of how many physical outputs are present on the rear panel. Any physical output can deliver the signal from any output in the matrix.

Every input includes a dynamic noise reduction filter to enhance dynamic signals and suppress steady state noise. This unique algorithm is a single ended, frequency selective process that significantly reduces noise from one or multiple sources.

When multiple units are stacked, Master and Slave units are automatically detected and configured. All data and audio from the Slave units in the system is gathered in the Master, so a single connection between a computer and the Master allows access to all units in the stack. The throughput latency of all audio inputs in a stack is automatically synchronized to maintain absolute signal phase at the audio outputs.

## Quick Start Essential Settings

***Install the ASPEN Software before connecting the processor to the computer USB port.***

### Wiring and Cable Connections

All inputs, outputs and control devices must be securely connected following the pinouts and polarity shown on pages 7 thru 9.

### Interconnect Multiple Units

When multiple units are used, interconnect them via the ASPEN ports on the rear panels. (see page 9)

### Critical Settings for Mixer Models

Several settings must be made before the processor will pass signals correctly:

- Input levels must be set
- Crosspoints must be defined
- Output levels must be set

The settings can be made using the computer interface or with the LCD. (see pages 10 and 16)

### Special Settings for SPN Conference

If the sound system includes an SPN Conference processor, two of the final mixes must be used to generate the input signals for the AEC (acoustic echo canceller) and another mix must be routed to the telephone send connection. Details for this critical setting are included in the Installation Guide for the SPN Conference.

### Signal Processing

Audio quality is significantly improved by using the various signal processing functions included in all channels. There is no “gas gauge” and no limitation of DSP resources regardless of how many processes and stages are enabled.

Every input channel includes settings for:

- Delay
- Noise reduction filter
- Equalization
- ADFE (auto digital feedback eliminator)
- Compressor

Every output channel includes settings for:

- Delay
- Equalization
- Compressor
- Limiter

\*SPNPower12 is to be developed at a future date

## Front Panels

Dual-board models in 2RU chassis include a front panel LCD and rotary style navigation control for adjustment without the need for a computer interface. Single board models require a computer interface for setup and adjustment.

The headphone output is used to monitor each final mix for diagnostics and system checkout. LEDs on the right side of the front panel indicate communications through serial and ethernet ports, provide an alert indicating an error, activity during firmware updates and power status.

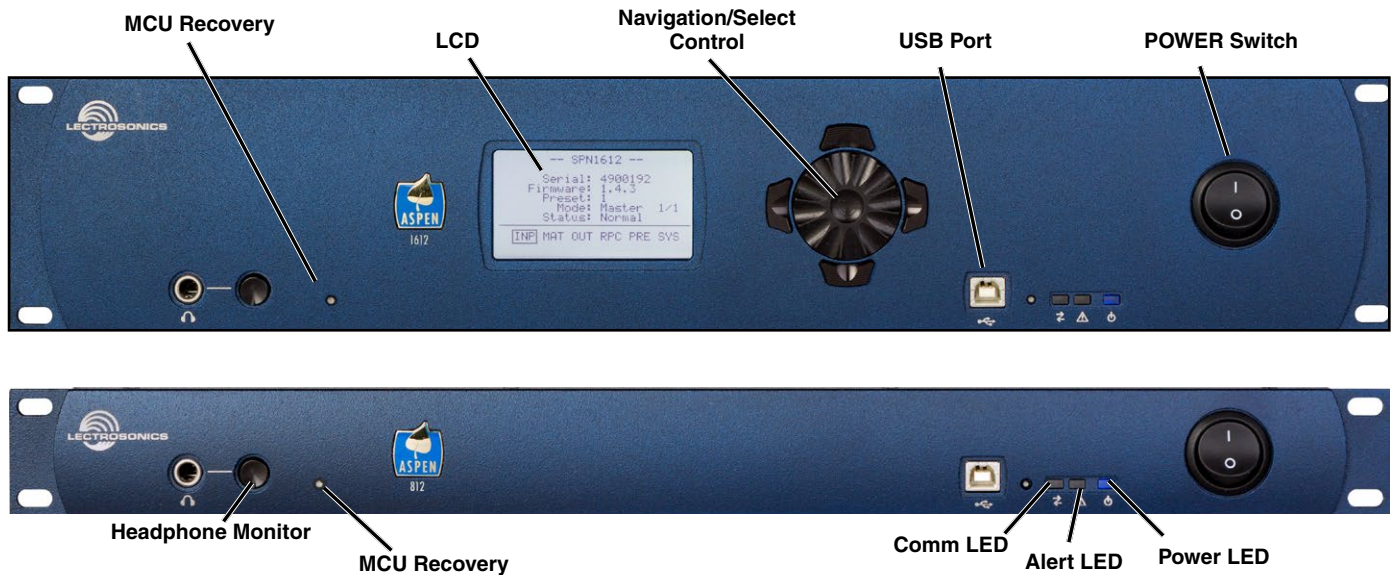

### Headphone Monitor

Used to monitor individual final mix buses as selected on the LCD. Standard 1/4 inch jack and level control. Drives both channels of stereo headphones.

On single board, 1RU models, the processor must be connected with the ASPEN control panel to gain access to the headphone monitor channel selection.

### MCU Recovery (recessed pushbutton)

Used in the procedure to recover from an interrupted firmware update procedure. See section on Firmware Update Procedure for details on usage.

### LCD

Allows setup and adjustment of most operating parameters and for minor adjustments without a computer interface.

### Navigation/Select Control

Used to navigate menus and make value selections and settings on the LCD.

### USB Port

Standard USB connector for the setup and control of a DMTH4 from an Windows® XP, Vista or 7 computer system\* with USB interface.

### Status LEDs

Comm LED - blinks to indicate USB, RS-232 and ethernet communication

Alert LED - blinks to indicate fault or error, glows white during firmware updates

Power LED - glows to indicate power ON

\*Windows is a registered trademark of Microsoft Corp.

# Rear Panels

## SPN1624

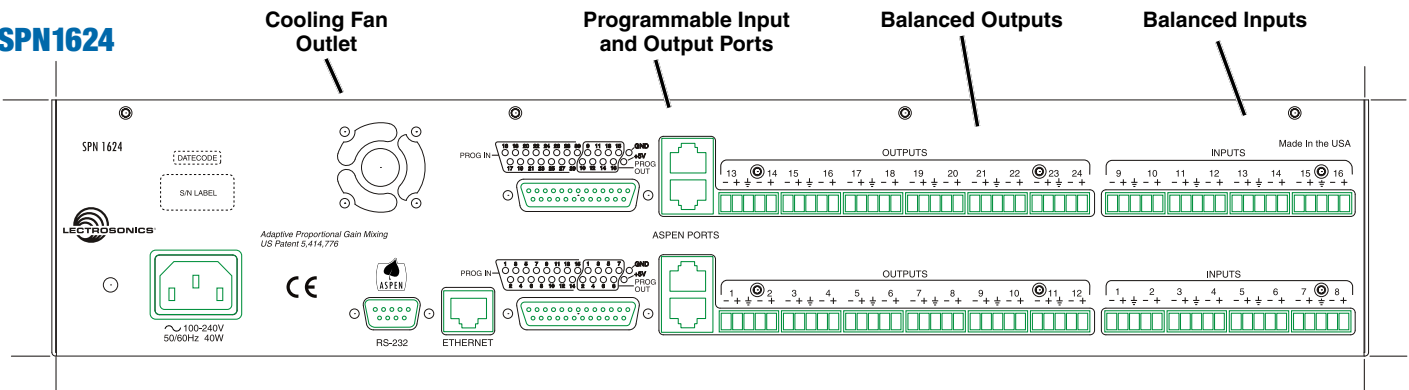

## SPN812

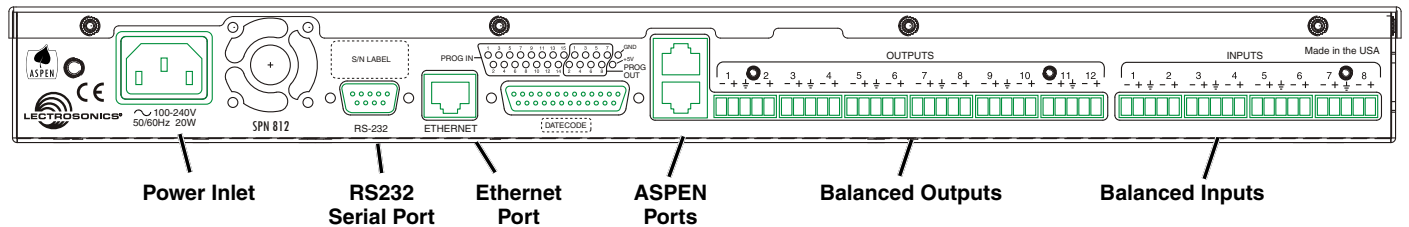

Above are examples of SPN mixers in 1RU and 2RU versions built around the 8 in/12 out board. Dual board models share a common power supply, RS-232 and Ethernet ports. The ASPEN ports and Programmable Input and Output ports are dedicated to each board.

### Power Inlet

The switching power supply will operate with line voltages between 100 and 240 VAC. The inlet socket is a standard 3-pin C14 type that accepts any cordset with a C13 connector.

### Cooling Fan

The microprocessor monitors the internal temperature of the processor and controls the variable speed fan as needed. Operating temperature is very well regulated.

### RS-232 and Ethernet Ports

Each host assembly provides RS-232 and Ethernet ports for communication with the microprocessor. The ports can be utilized simultaneously for monitoring, setup and control.

### ASPEN Ports

This gigabit bus transports audio and data from one board to the next through CAT-6 cabling and RJ-45 connectors. Processors are normally installed with the Master unit on top and Slave units below it. The cabling is then connected from the uppermost jack on one board to the lowermost jack on the unit just above it. See page 9 for more information.

### Balanced Inputs

Every mic/line input is a balanced, differential type with adjustable gain from -10 to +60 dB. Connectors are a standard 5-pin Phoenix depluggable type with adjacent channels sharing a common ground.

### Balanced Outputs

All outputs are a balanced, differential type. Channels 1 through 8 and 17 through 24 on each board are nominal line level outputs with gain adjustment from OFF, -69 to +20 dB. Channels 9 through 16 on each board are the same, except switchable attenuation of 20 and 40 dB is also available to reduce the output to the "mic level" range.



# Hardware Installation

## Installing the chassis into a rack

Install the chassis so that the cooling fan vent is not blocked. Mount with 4 rack screws using the appropriate mounting holes. Use nylon washers to prevent damage to the front panel's finish when tightening the mounting screws.

All ASPEN processors have internal switching power supplies that can tolerate voltages ranging from 100 to 240 VAC. Use an approved power cord with an IEC 60320 C13 connector.

## Cables

It is recommended to use lacing bars for cable strain relief when mounting in a rack. Use only professional audio cable with proper shielding – typically, two conductor plus ground/shield.

## Audio Connectors

The analog audio inputs and outputs are connected through 5 pin de-pluggable connectors. Strip the insulation back 1/8 to 3/16" but do not tin (apply solder to) the leads. Insert the wire into a de-pluggable connector, leaving less than 1 mm of bare wire exposed, then tighten the retaining screw.

**Caution: Do not overtighten the screws.**

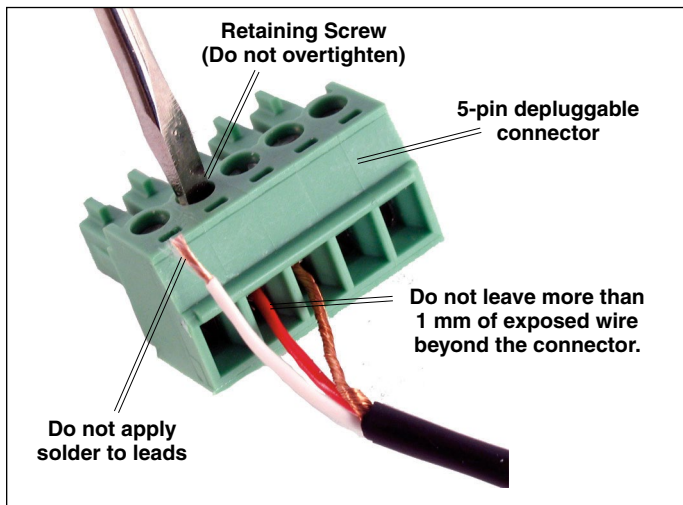

Note the labeling on the rear panel for the positive and negative leads. Ground is shared between two connections (the center pin).

**Note:** ASPEN processors do not have a "pin 1 problem." Inputs and outputs are true differential connections.

## Audio Inputs – Unbalanced

Unbalanced audio sources include items such as consumer VCR's, DVD players, etc., which can be connected with either two wire or three wire cables. The (+) terminal of the source is connected to the (+) terminal of the processor. The shield and (-) connections are made as shown here.

Three wire cables should have the shield connected to the (-) connector at the source end of the cable.

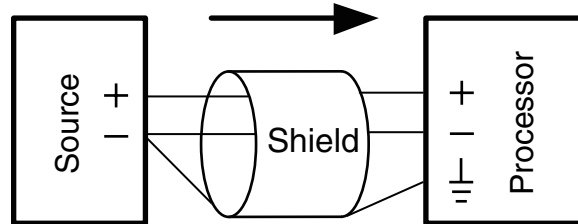

Unbalanced source to ASPEN input – 3-wire cable

Two wire cables should have a jumper between the processor (-) input and ground.

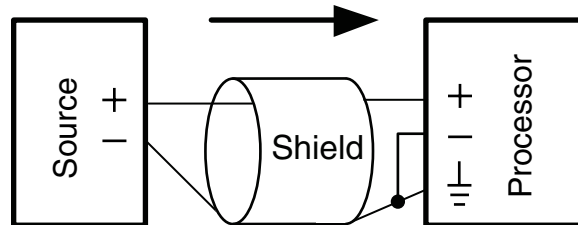

Unbalanced source to ASPEN input – 2-wire cable

## Audio Inputs – Balanced

Balanced audio sources connect to the processor inputs in a straight "pin to pin" configuration.

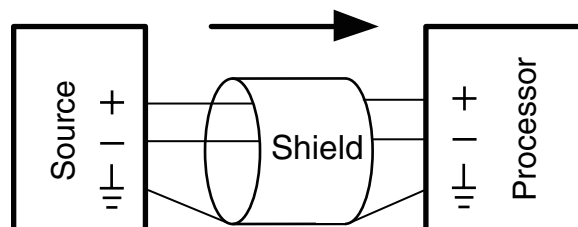

Balanced source to ASPEN input

## Audio Outputs

The line outputs are a balanced differential configuration which can drive balanced or unbalanced inputs on other audio equipment with the wiring shown here.

Balanced output to a balanced input is a straightforward “pin to pin” configuration.

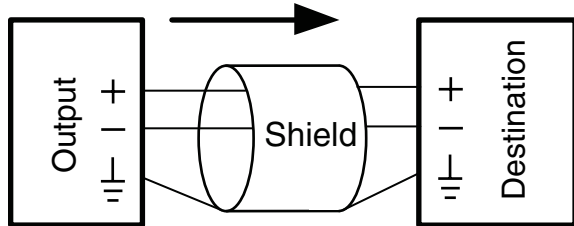

Balanced output to balanced destination

Balanced output to unbalanced input with a 3-wire cable is connected with the cable shield added to the (-) terminal on the destination input.

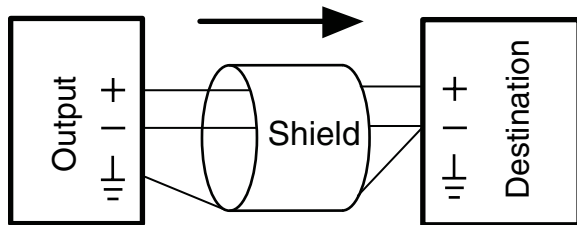

Balanced output to unbalanced destination – 3-wire cable

Balanced output to unbalanced input with a 2-wire cable is connected with the output (-) connected to the cable shield at the processor output.

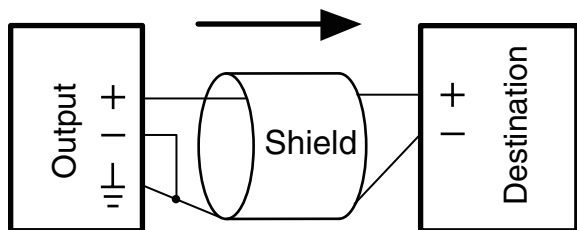

Balanced output to unbalanced destination – 2-wire cable

## Programmable Inputs

Programmable inputs are provided to enable external control over a variety of parameters. Each input can respond to a contact closure, a DC voltage source, or the variable voltage output from a potentiometer. The following illustrates common connections to the programmable input pins.

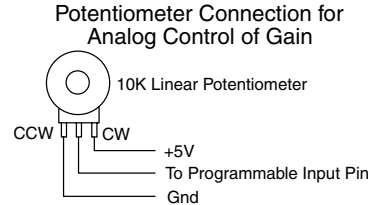

Contact Closure as Programmable Input

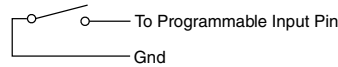

DC Voltage Source as Programmable Input

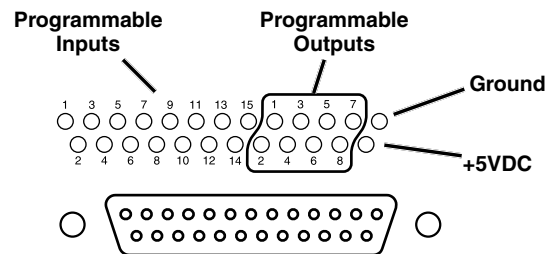
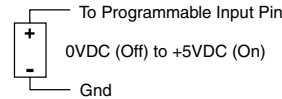

## Programmable Outputs

Programmable outputs are used for several purposes:

- indicate the current state of a programmable input
- monitor activity on telephone or codec interfaces
- monitor active preset changes

Each programmable output is the electrical equivalent of a contact closure to ground. When a programmable output is “active,” it conducts current to ground. When the programmable output is “inactive,” no current flows to ground. The maximum usable voltage for the programmable outputs is 40 V and they will safely conduct up to 100 mA DC continuous.

Both LEDs and 5V relay coils can be powered by the +5 V DC pins on the programmable input connector, as long as the maximum combined current for all LEDs and relay coils does not exceed 100 mA.

(see next page)

## Programmable Outputs (cont'd)

LED is ON when the programmable output is active

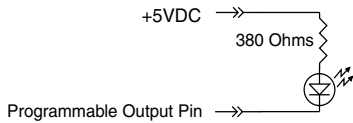

LED is OFF when the programmable output is active

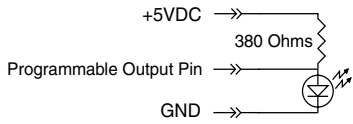

Relay is on when the programmable output is active

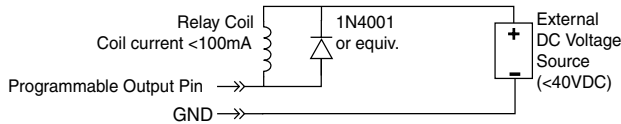

**Note:** The diagram above shows an external DC source powering the relay coil. This is necessary whenever coil voltages exceed 5 volts.

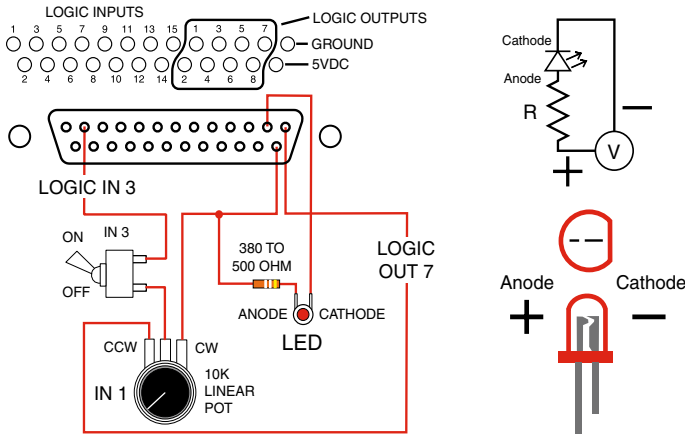

## ASPEN to PC RS-232 Port Wiring

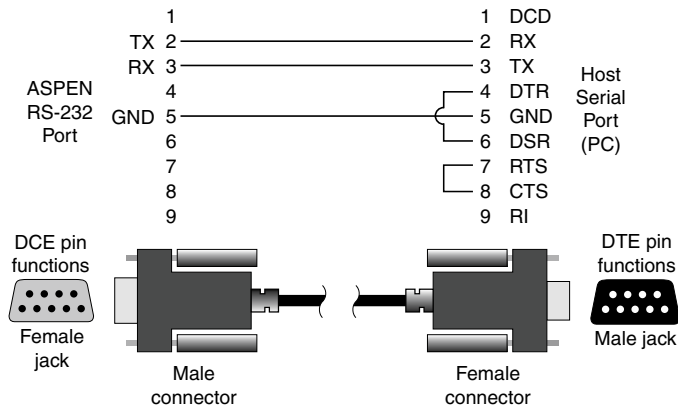

## Crestron/AMX RS-232 Port Wiring

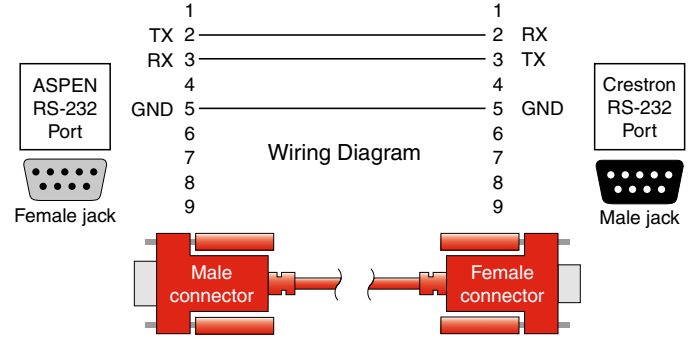

## Cabling Of Stacked Units

In a stacked configuration, ASPEN processors must be interconnected as shown here. Each Slave unit in a stack gathers data and audio signals from the unit below it, adds its own signals and passes the total on to the unit above it. At the top of the stack, the Master unit gathers all signals from below, adds its own and then sends the total back down the bus to all Slave units below it. In this manner, all Slave units have access to all inputs on any unit in the stack.

Each circuit board has an upper and a lower CAT-5 connector. Since there are two circuit boards in a 2RU unit such as the SPN1624, the circuit boards are connected in the same manner as if they were in separate chassis. The ASPEN bus is bidirectional, handling data and audio signal forward and back propagation through a single cable connection.

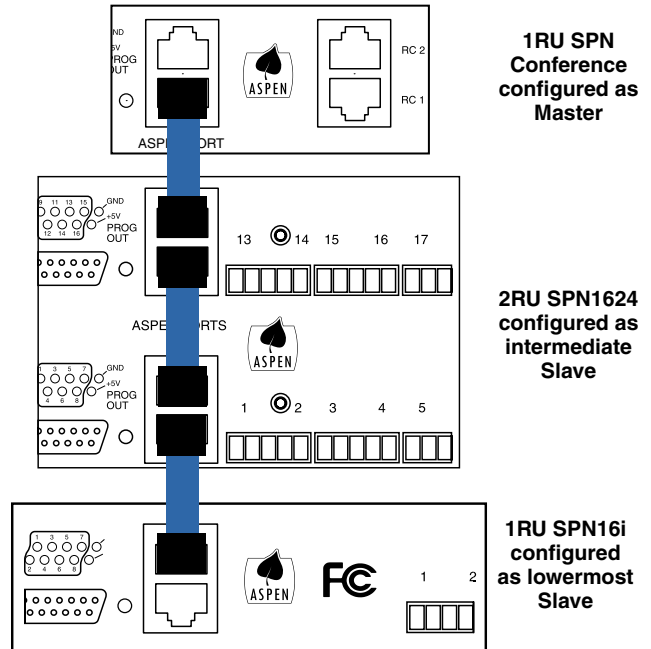

The processors automatically configure themselves for Master and Slave status as determined by the cabling. If a unit is connected to another unit above it through the upper connector, it is automatically configured as a Slave. If there is no unit above it, then it becomes a Master.

# Using the LCD

The LCD can be used to perform a simple setup, to check current settings or make adjustments without using a computer interface.

## Boot Screen

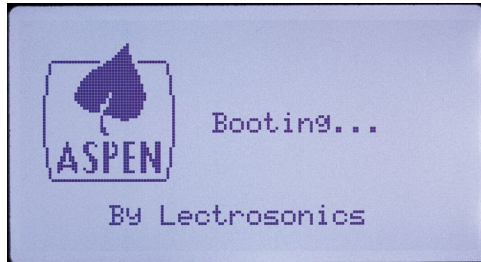

## Main Window

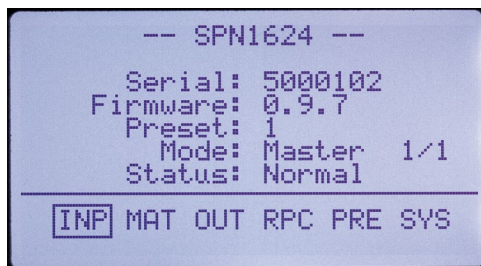

## Navigation Control

The navigation control for the LCD consists of a rotary control and four directional buttons for selection of menu items and to enter values. The four outer buttons are referenced as LEFT, RIGHT, UP and DOWN. Pressing the center of the rotary control provides a “select” or “center switch” function.

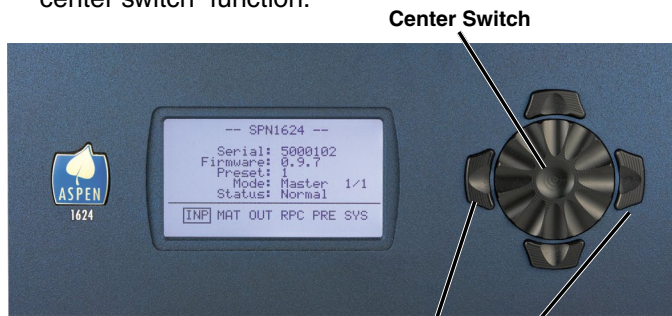

Press both Left and Right buttons to turn the LCD backlight OFF and ON

The LEFT (9:00 o'clock) functions as a BACK button to return to the previous menu from setup screens as prompted by the ◀ symbol in the lower left corner of the LCD.

## Shortcut Buttons

- **LCD Backlight Toggle:** Press both the LEFT and RIGHT (9:00 and 3:00 o'clock) buttons to turn the backlight on and off.
- **Emergency Mute (panic button):** Pressing the UP and DOWN buttons together will mute all outputs to remedy situations such as runaway feedback.
- **Restore Default Settings (Master Reset):** Hold in the LEFT and UP buttons while turning on the power to restore the factory default settings. The Alert LED will glow white during the process, which takes about 75 seconds to complete.

## Panel Lock/Unlock

From the Main Window, use the rotary control to select SYS in the lower row window and press the center switch. Then scroll down with the rotary control to the menu item named *Front Panel Lock* and press the center switch to enter the setup screen.

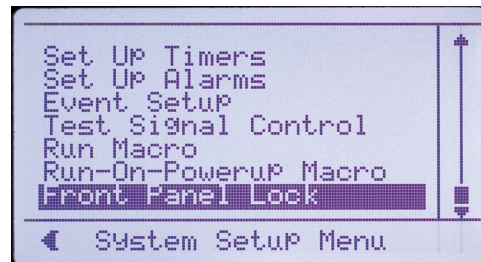

Select the *Unlocked/Locked* item with the rotary control, press the center switch.



A prompt will appear asking you to enter the passcode.



The factory default passcode is five presses of the center switch. Once the correct passcode is entered, the panel will allow access to the screen items to change the unlocked/locked status, enter a new passcode and save the results.

The passcode can consist of any combination of five successive button presses of the four outer switches and the center switch such as: LEFT > RIGHT > UP > DOWN > CENTER.

After selecting the mode and/or changing the passcode, select *SAVE* with the rotary control and press the center switch to save the settings.

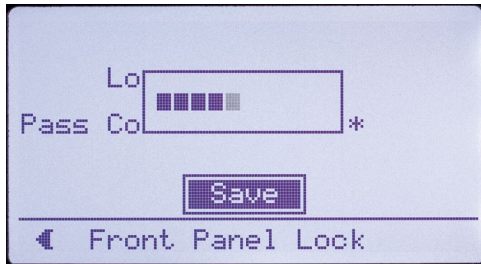

A progress bar will appear as the settings are saved.

Press the LEFT (9:00 o'clock) button to return to the previous screen.

### Master Reset

Hold the LEFT and UP buttons in at power up to restore factory default settings.



**WARNING:** Master Reset will remove all stored settings, unlock the control panel and reset the passcode to five center button presses.

Master Reset takes about 75 seconds to complete while the center (white) LED on the front panel stays lit. The display will then return to the Main Window and the right (blue) LED will light up to indicate power ON and a "ready" status.

### Initial Setup

The processor requires a minimum setup before it will pass signals:

- Input Gain Value
- Crosspoint Gain Value
- Output Gain Value

These three minimum settings can be made with the LCD or software GUI.

### Input Setup

Select [INP] on the Main Window.

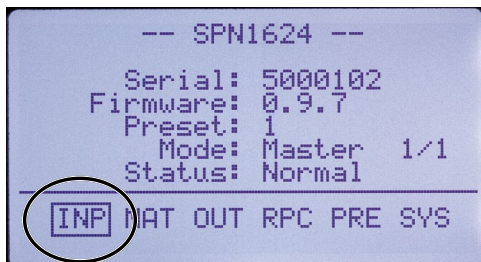

Select Mic/Line Input Setup (Input Levels is a dynamic display that shows bar graphs of activity).



Navigate to each cell and enter a value. For microphones, 40 to 50 dB is a normal value. For line levels, 0 dB is a commonly used value. If phantom power is needed, be sure to check the 48V cell for each microphone using the rotary control.

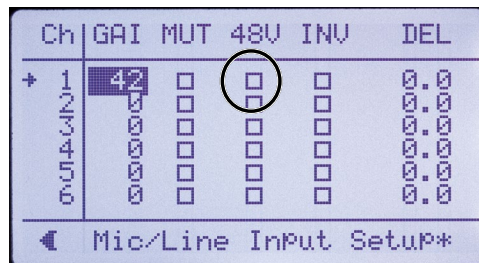

### Matrix Crosspoint Setup

Select [MAT] on the Main Window.

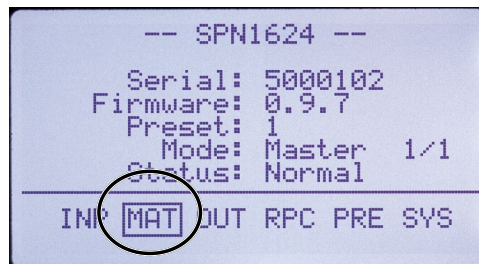

Scroll to the desired Crosspoint setting and select it. The UP and DOWN buttons can also be used to scroll the menu items.

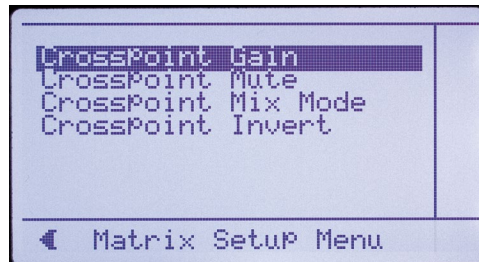

Adjust to the desired value with the rotary control and press the control to store the value. (the Crosspoint Gain setting screen is shown here as an example)

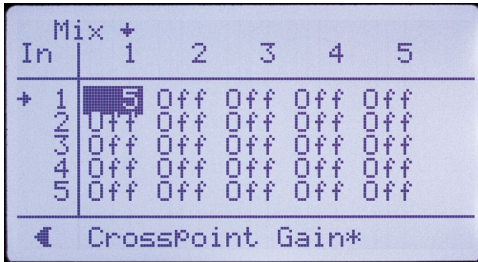

After all values have been set, press the LEFT button to return to the previous menu.

### Output Setup

Select [OUT] in the Main Window.

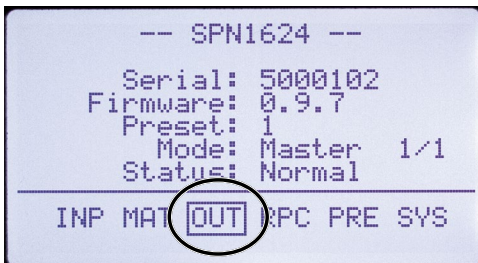

Scroll to and select *Output Setup*.



Output Levels is a real time bar graph display

Select the Setup item to adjust output gain

Navigate to the desired output, select it and adjust the value with the rotary control. Press the control inward to store the setting.



After all settings have been made, press the LEFT button to return to the previous menu.

### Additional Filters and Processing

After the basic signal flow and levels are established, further refinements can be added with the extensive set of signal processing built into the processor. Browse the menus for inputs and outputs to discover the available resources.

### Rear Panel Controls

Select [RPC] in the Main Window to access a setup menu to configure external controls such as pots and switches. While settings can be made with the LCD interface, it is recommended that you use the software GUI instead.

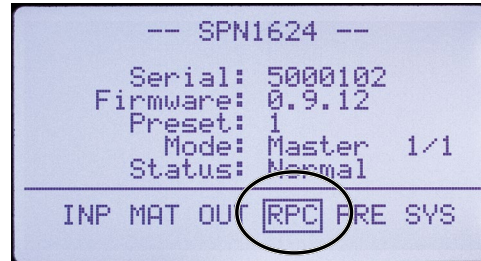

### Preset Recall and Settings

Select [PRE] in the Main Window to access a setup menu to store and recall presets and other options to define preset activities. It is useful for information, however, it is recommended that you use the software GUI instead, which will provide access to presets stored on the computer disk drive.

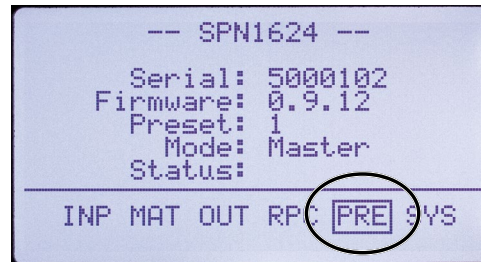

### Global System Settings

Select [SYS] in the Main Window to access a setup menu for a variety of global settings including head-phone monitoring, date and time setup, timer and event programming, front panel lockout, network interface settings and others.

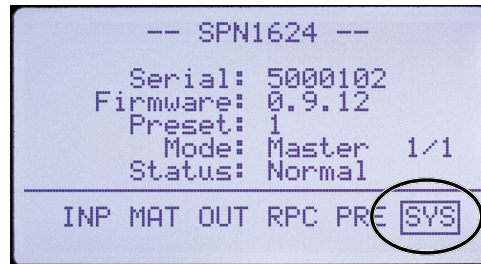

## Network Interface

**IMPORTANT:** Always consult your network administrator before attempting to connect and configure a processor for a network interface.

The [SYS] tab menu also includes Network Settings.



The settings must be correctly set before connecting into a network.

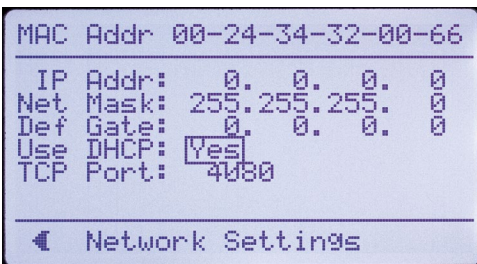

## Stacking Multiple Units

If Slave units are not powered up when the Master unit boots up, the Slave may not be detected for several minutes. It is good practice to turn on all units simultaneously or turn on Slave units before turning on the Master unit.

Check the LCD display on the Master unit to see if it has detected all the Slaves.

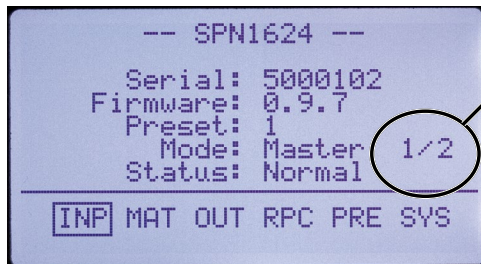

Check Mode on the Master unit to verify the detection of all Slaves.

Shown here is 1 of 2.

The Master unit will always be number one in the stack as shown here, and each slave will be numbered in the order that it is connected with the cabling of the ASPEN port jacks.

## Software and Firmware Updates

Check for the latest versions of the control panel software and to see that the hardware includes the latest firmware.

ASPEN models with a front panel LCD will display the firmware version on the LCD and in the control panel GUI after the software is installed. Other models display the firmware version in the GUI only. Firmware updates require that the ASPEN software be installed to enable a connection and use the update utility included in the software.

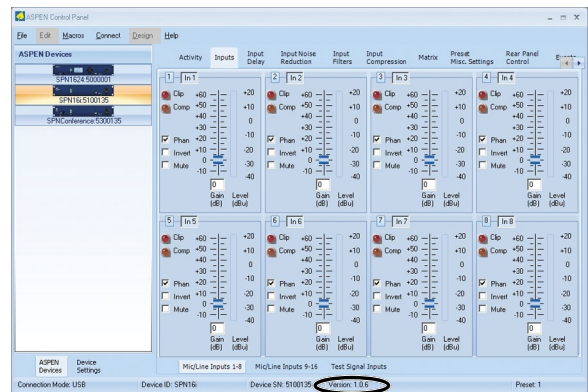
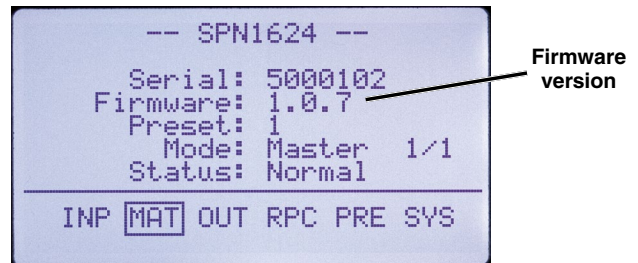

## Obtaining Updates

The latest versions of software and firmware are provided on the ASPEN USB flash drive supplied with the unit and downloadable from the Aspen Support section on Lectrosonics website.

Lectrosonics home page: <http://www.lectrosonics.com>

**ASPEN Software:** Uninstall any previous version before installing an updated version.

Downloaded files arrive in a .zip format. Extract the files to a folder on your local drive and then run "setup.exe" to install the program.

**Firmware Updates:** Downloaded files arrive in a single .zip file with the model number and version indicated by the filename.

Extract the file to a folder on your local drive. The resulting filename will indicate the model number and version, followed by the extension ".update."

# Creating an ASPEN Installer Disk

If you do not have the ASPEN USB flash drive supplied with the processor, download the ASPEN Installation Disk .iso file. Visit <http://www.lectrosonics.com>, hover your mouse over **Support** and click on **Aspen Support**, then **Installation Disc**.

Save the file to your local drive in a familiar location. Open a disk copier utility such as Roxio Classic and select the operation to *Burn from a Disk Image File*.

**NOTE:** The .iso file cannot be simply copied to the disk. The disk recording utility must run a process that creates a disk from a stored image file.

The .iso file format is recognized by almost any disk creation software.

# Firmware Update Procedure

- 1) Install ASPEN software. See the next page for an example of the installation procedure.
- 2) Launch the software. After the panel opens, click on *File > Update*. The *Update Wizard* screen will open to confirm that the software is ready for a firmware update, with instructions on connecting and configuring the processor.
- 3) On the processor, hold the recessed push button switch in with a pen or paper clip and turn on the power to the processor. The unit will boot into the *Firmware Update...* mode and the white Alert LED on the processor front panel will glow.

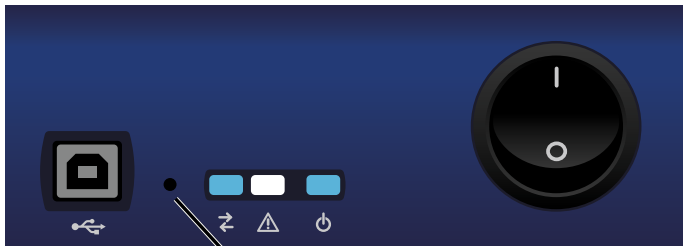

Recessed pushbutton for firmware updates

- 4) Connect the processor to the computer with the USB cable. When the USB connection is confirmed (typically with a beep sound on the computer), continue by following the on screen prompts in the *Update Wizard*.
- 5) When prompted, use the "Browse" button to point at the firmware update file and click *Next* to continue.

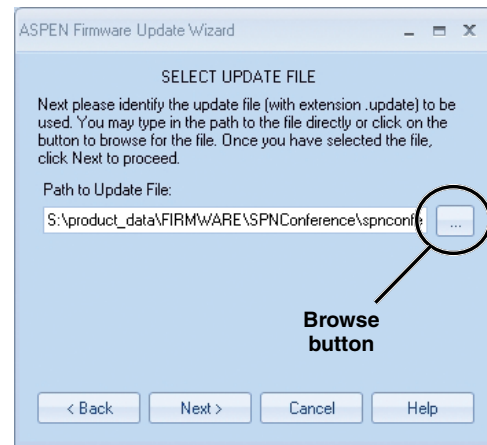

- 6) Do not disturb the USB cable connection during the update process. The firmware update takes up to 15 minutes to complete. Be sure the computer does not "Time Out" during the update process.
- 7) When the update is complete, click *Finish* to exit the Update Wizard.
- 8) Cycle the power on the processor to restart using the updated firmware.

# MCU Recovery from Interrupted Firmware Update Procedure

If instructed to do so by Lectrosonics Customer Support, the firmware in a non-functioning unit can be restored.

Launch the Control Panel program. After the panel opens, click on **Connect->Update Firmware...**

In the lower part of the screen is a check box that is used only for the recovery process. When the box is checked, the instructions will change to describe the recovery procedure.

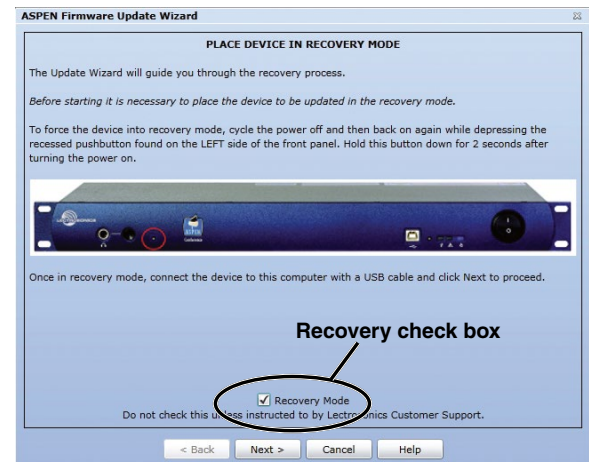

Follow the on-screen prompts to return the unit to normal operation.

# Software/USB Driver Installation

**NOTE: Uninstall previous version before installing the software.**

The example shown here illustrates the installation procedure using a Windows operating system. The screens that appear at each step using another operating system will vary, but the general steps are very similar.

Insert the ASPEN USB flash drive, then follow the steps to begin the installation.

1. Navigate to the USB drive folder and click on the Control Panel folder.

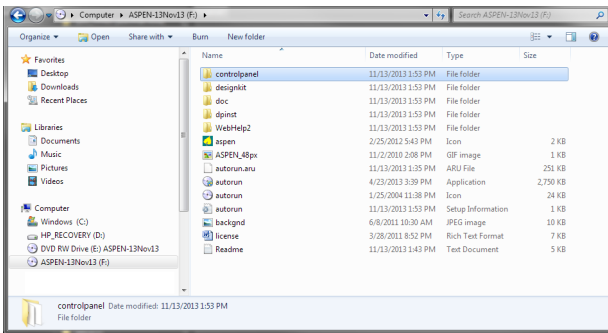

2. Click on "setup".

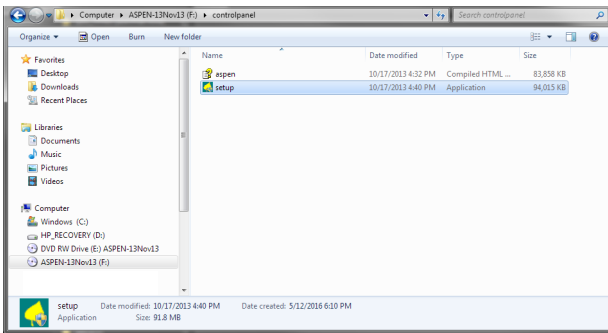

3. Click on Yes to allow the program to make changes to your computer.
4. The ASPEN Software Installer opens.

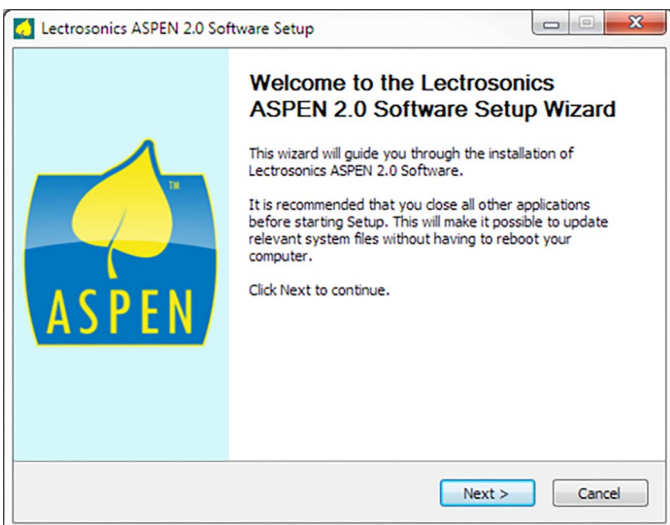

5. The End User License Agreement screen appears. Click on / Agree to continue.

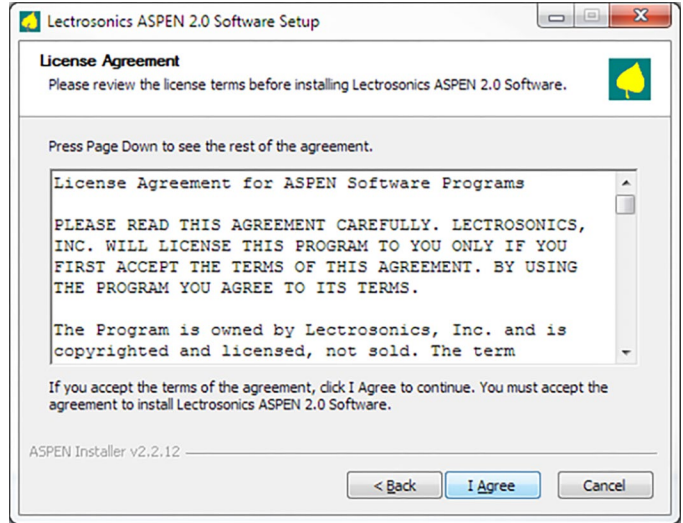

6. In the Choose Components Screen, check all three boxes and click on Install to continue.

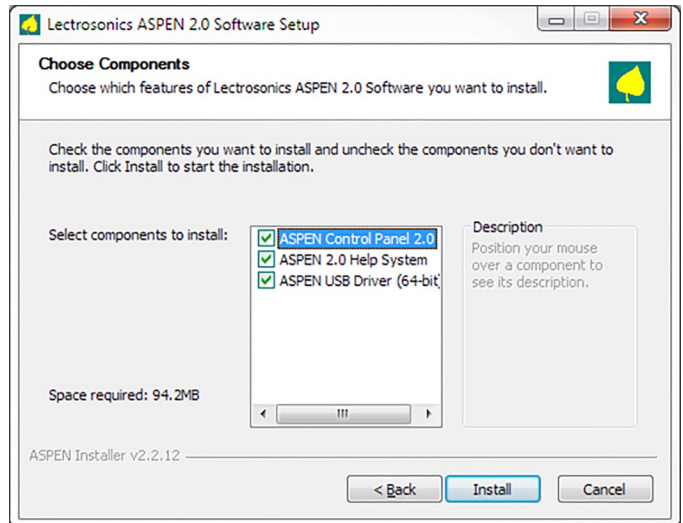

7. The installation Wizard will walk you through installation. When complete, the final screen will appear. Click on Finish to close the installation.

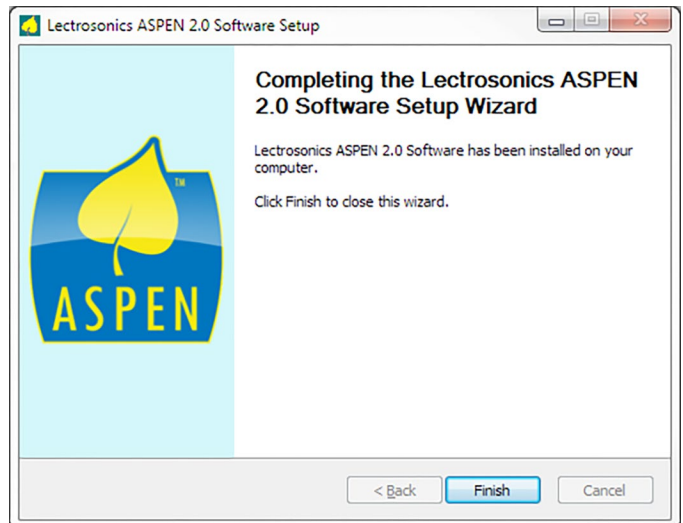

# Using the Software GUI for Minimum Setup

An Input, crosspoint and output must be defined to create a path that allows the processor to pass a signal. This required minimum setup can be accomplished quickly using the software GUI.

Launch the ASPEN software. The first screen to appear is blank with tabs at the top of the window to select the desired action.

Select the **Connect** tab and then click on the method of communication; in this example, USB. Click OK in the Master unit discovery popup window.

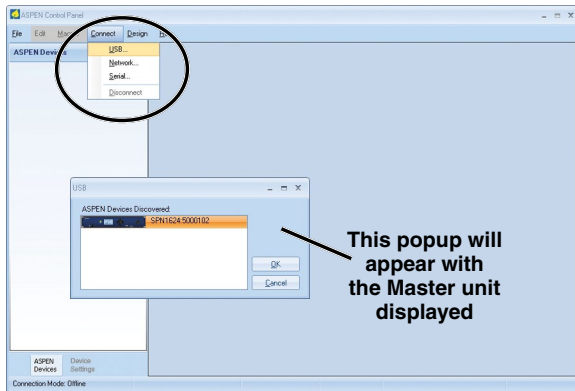

The left side of the control panel will appear with a list of processors that are connected. Click on a unit in the list to open its control panel.

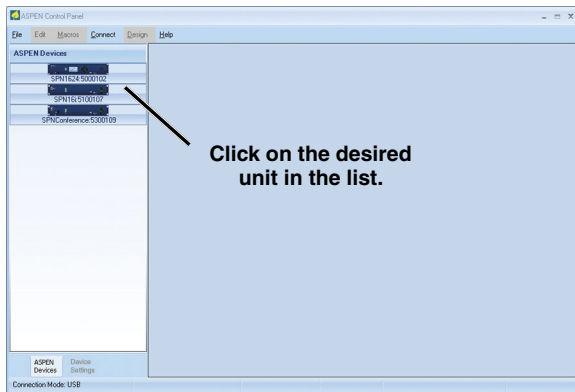

The panel opens to the **Activity** window, which is a real time level display for all channels.

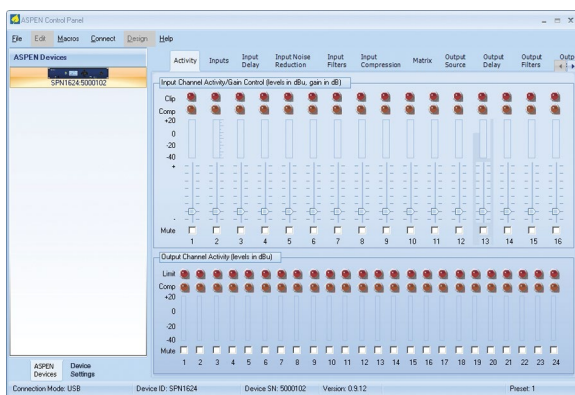

Define inputs, crosspoints and outputs on the appropriate tabs for a required minimum setup.

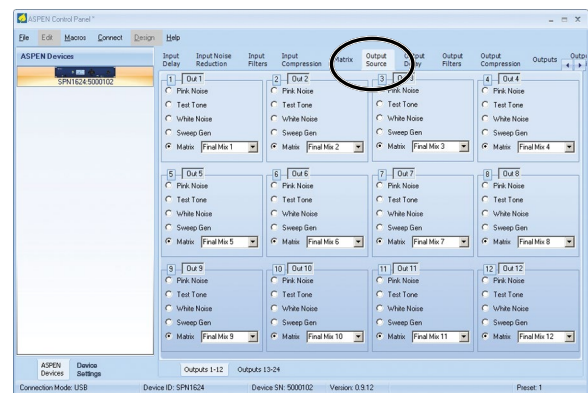
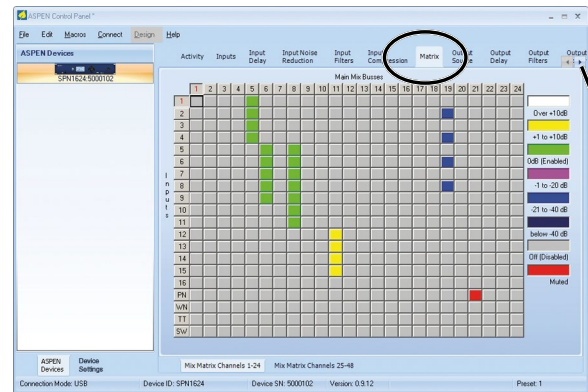
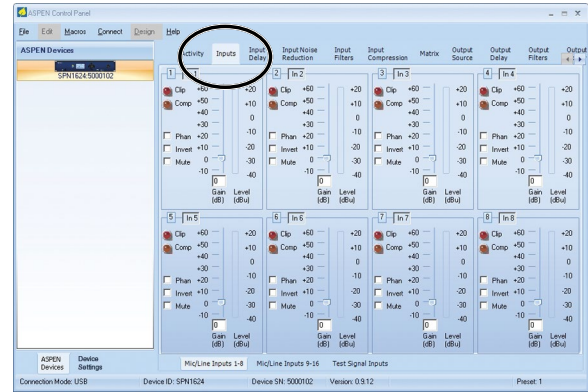

The **Device Settings** tab opens access to several setup screens such as **Preset Management**.

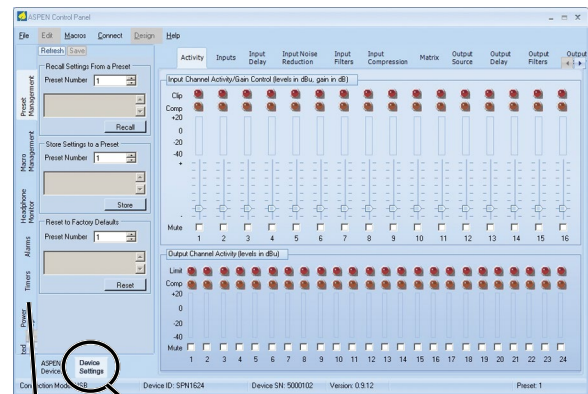

**Device Settings tab**  
Category bar for access to setup screens

## Stacking Multiple Units

If Slave units are not powered up when the Master unit boots up, the Slave may not be detected for several minutes. It is good practice to turn all units on simultaneously or turn on Slave units before turning on the Master unit.

The available processors will appear in a “stack” on the left side of the control panel. The Master unit will appear at the top of the stack, with Slave units below it appearing in the order that they are connected with the cable connections to the ASPEN port jacks.

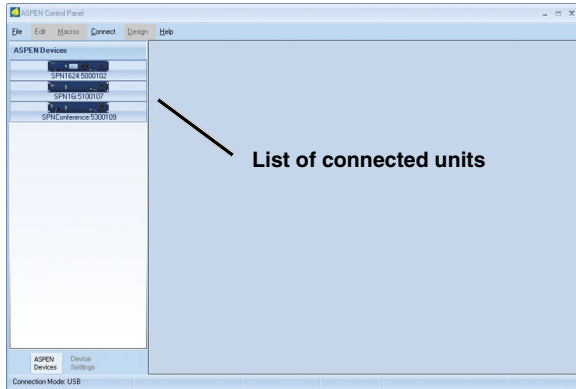

Refer to the cabling diagram for the ASPEN ports in the section entitled Hardware Installation.

## Refer to the Help Files

Once the processors are installed, configured and communicating with a computer system, refer to the Help files in the software GUI for additional information regarding the available settings, adjustments and control.

## Service and Repair

If your system malfunctions, you should attempt to correct or isolate the trouble before concluding that the equipment needs repair. Make sure you have followed the setup procedure and operating instructions. Check the interconnecting cables and then go through the **Troubleshooting** section in this manual.

We strongly recommend that you **do not** try to repair the equipment yourself and **do not** have the local repair shop attempt anything other than the simplest repair. If the repair is more complicated than a broken wire or loose connection, send the unit to the factory for repair and service. Don't attempt to adjust any controls inside the units. Once set at the factory, the various controls and trimmers do not drift with age or vibration and never require readjustment. **There are no adjustments inside that will make a malfunctioning unit start working.**

LECTROSONICS' Service Department is equipped and staffed to quickly repair your equipment. In warranty repairs are made at no charge in accordance with the terms of the warranty. Out-of-warranty repairs are charged at a modest flat rate plus parts and shipping. Since it takes almost as much time and effort to determine what is wrong as it does to make the repair, there is a charge for an exact quotation. We will be happy to quote approximate charges by phone for out-of-warranty repairs.

## Returning Units for Repair

For timely service, please follow the steps below:

- A.** DO NOT return equipment to the factory for repair without first contacting us by e-mail or by phone. We need to know the nature of the problem, the model number and the serial number of the equipment. We also need a phone number where you can be reached 8 A.M. to 4 P.M. (U.S. Mountain Standard Time).
- B.** After receiving your request, we will issue you a return authorization number (R.A.). This number will help speed your repair through our receiving and repair departments. The return authorization number must be clearly shown on the **outside** of the shipping container.
- C.** Pack the equipment carefully and ship to us, shipping costs prepaid. If necessary, we can provide you with the proper packing materials. UPS or FEDEX is usually the best way to ship the units. Heavy units should be "double-boxed" for safe transport.
- D.** We also strongly recommend that you insure the equipment, since we cannot be responsible for loss of or damage to equipment that you ship. Of course, we insure the equipment when we ship it back to you.

### Lectrosonics USA:

**Mailing address:**  
Lectrosonics, Inc.  
PO Box 15900  
Rio Rancho, NM 87174  
USA

**Shipping address:**  
Lectrosonics, Inc.  
561 Laser Rd. NE, Suite 102  
Rio Rancho, NM 87124  
USA

**Telephone:**  
(505) 892-4501  
(800) 821-1121 Toll-free  
(505) 892-6243 Fax

**Web:**  
www.lectrosonics.com

**E-mail:**  
sales@lectrosonics.com

### Lectrosonics Canada:

**Mailing Address:**  
720 Spadina Avenue,  
Suite 600  
Toronto, Ontario M5S 2T9

**Telephone:**  
(416) 596-2202  
(877) 753-2876 Toll-free  
(877-7LECTRO)  
(416) 596-6648 Fax

**E-mail:**  
Sales: colinb@lectrosonics.com  
Service: joe@lectrosonics.com





## LIMITED THREE YEAR WARRANTY

The equipment is warranted for three years from date of purchase against defects in materials or workmanship provided it was purchased from an authorized dealer. This warranty does not cover equipment which has been abused or damaged by careless handling or shipping. This warranty does not apply to used or demonstrator equipment.

Should any defect develop, Lectrosonics, Inc. will, at our option, repair or replace any defective parts without charge for either parts or labor. If Lectrosonics, Inc. cannot correct the defect in your equipment, it will be replaced at no charge with a similar new item. Lectrosonics, Inc. will pay for the cost of returning your equipment to you.

This warranty applies only to items returned to Lectrosonics, Inc. or an authorized dealer, shipping costs prepaid, within three years from the date of purchase.

This Limited Warranty is governed by the laws of the State of New Mexico. It states the entire liability of Lectrosonics Inc. and the entire remedy of the purchaser for any breach of warranty as outlined above. NEITHER LECTROSONICS, INC. NOR ANYONE INVOLVED IN THE PRODUCTION OR DELIVERY OF THE EQUIPMENT SHALL BE LIABLE FOR ANY INDIRECT, SPECIAL, PUNITIVE, CONSEQUENTIAL, OR INCIDENTAL DAMAGES ARISING OUT OF THE USE OR INABILITY TO USE THIS EQUIPMENT EVEN IF LECTROSONICS, INC. HAS BEEN ADVISED OF THE POSSIBILITY OF SUCH DAMAGES. IN NO EVENT SHALL THE LIABILITY OF LECTROSONICS, INC. EXCEED THE PURCHASE PRICE OF ANY DEFECTIVE EQUIPMENT.

This warranty gives you specific legal rights. You may have additional legal rights which vary from state to state.



581 Laser Road NE • Rio Rancho, NM 87124 USA • [www.lectrosonics.com](http://www.lectrosonics.com)  
(505) 892-4501 • (800) 821-1121 • fax (505) 892-6243 • [sales@lectrosonics.com](mailto:sales@lectrosonics.com)

29 June 2016