

Q16pro Gen2

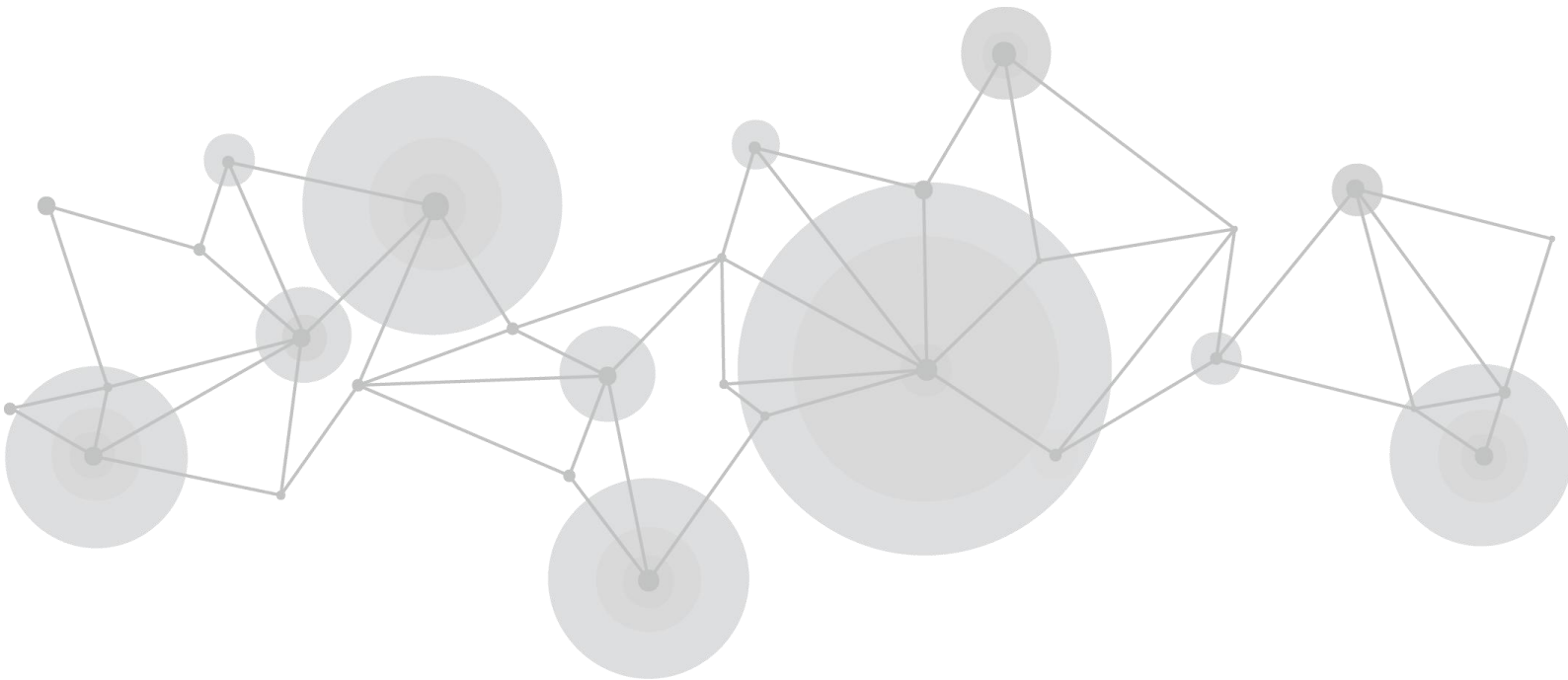

User Manual



Article NO: RGB-RD-UM-Q16pro E001
Version NO: V1.1

Content

<i>Declarations</i>	3
FCC/Warranty	3
Operators Safety Summary	4
Installation Safety Summary	4
<i>Chapter 1 Your Product</i>	6
1.1 Product Overview	6
1.2 Key Features	6
1.3 Front Panel	7
1.3.1 Main Menu	7
1.4 Rear Panel	13
1.5 Dimension	14
<i>Chapter 2 Install Your Product</i>	16
2.1 Plug in Power	16
2.2 Connect Signal Source and Control Computer	16
2.3 Turn on Your Product	17
<i>Chapter 3 Use Your Product</i>	18
3.1 CPX Controls Q16pro	18
3.1.1 CPX Front Panel	18
3.1.2 CPX Rear Panel	20
3.1.3 Connect CPX and Q16pro	20
3.1.4 Use Function Keys	21
3.1.5 Use Main Menu	26
3.2 XPOSE 2.0 Installation	31
3.3 XPOSE Operation	34
3.3.1 Login in XPOSE	34
3.3.2 System Setting	35
3.3.3 Output Input Overview	39
3.3.4 Display Management	46
3.3.5 Layer Management	49
3.3.6 Preset Management	54
<i>Chapter 4 Order Code</i>	56
4.1 Product Code	56
4.2 Module Code	56
4.2.1 Input Modules	56
4.2.2 Output Modules	56
4.2.3 Others	56
<i>Chapter 5 Support</i>	57
5.1 Contact Us	57
<i>Chapter 6 Appendix</i>	57
6.1 Terms & Definitions	58
6.2 Revision History	64

Thank you for choosing our product!

This User Manual is designed to show you how to use this video processor quickly and make use of all the features. Please read all directions and instructions carefully before using this product.

Declarations

FCC/Warranty

Federal Communications Commission (FCC) Statement

This equipment has been tested and found to comply with the limits for a class A digital device, pursuant to Part 15 of the FCC rules. These limits are designed to provide reasonable protection against harmful interference when the equipment is operated in a commercial environment. This equipment generates, uses, and can radiate radio frequency energy and, if not installed and used in accordance with the instruction manual, may cause harmful interference to radio communications. Operation of this equipment in a residential area may cause harmful interference, in which case the user will be responsible for correcting any interference.

Guarantee and Compensation

RGBlink provides a guarantee relating to perfect manufacturing as part of the legally stipulated terms of guarantee. On receipt, the purchaser must immediately inspect all delivered goods for damage incurred during transport, as well as for material and manufacturing faults. RGBlink must be informed immediately in writing of any complains.

The period of guarantee begins on the date of transfer of risks, in the case of special systems and software on the date of commissioning, at latest 30 days after the transfer of risks. In the event of justified notice of compliant, RGBlink can repair the fault or provide a replacement at its own discretion within an appropriate period. If this measure proves to be impossible or unsuccessful, the purchaser can demand a reduction in the purchase price or cancellation of the contract. All other claims, in particular those relating to compensation for direct or indirect damage, and also damage attributed to the operation of software as well as to other service provided by RGBlink, being a component of the system or independent service, will be deemed invalid provided the damage is not proven to be attributed to the absence of properties guaranteed in writing or due to the intent or gross negligence or part of RGBlink.

If the purchaser or a third party carries out modifications or repairs on goods delivered by RGBlink, or if the goods are handled incorrectly, in particular if the systems are commissioned operated incorrectly or if, after the transfer of risks, the goods are subject to influences not agreed upon in the contract, all guarantee claims of the purchaser will be rendered invalid. Not included in the guarantee coverage are system failures which are attributed to programs or special electronic circuitry provided by the purchaser, e.g. interfaces. Normal wear as well as normal maintenance are not subject to the guarantee provided by RGBlink either.

The environmental conditions as well as the servicing and maintenance regulations specified in this manual must be complied with by the customer.

Operators Safety Summary

The general safety information in this summary is for operating personnel.

Do Not Remove Covers or Panels

There are no user-serviceable parts within the unit. Removal of the top cover will expose dangerous voltages. To avoid personal injury, do not remove the top cover. Do not operate the unit without the cover installed.

Power Source

This product is intended to operate from a power source that will not apply more than 230 volts rms between the supply conductors or between both supply conductor and ground. A protective ground connection by way of grounding conductor in the power cord is essential for safe operation.

Grounding the Product

This product is grounded through the grounding conductor of the power cord. To avoid electrical shock, plug the power cord into a properly wired receptacle before connecting to the product input or output terminals. A protective-ground connection by way of the grounding conductor in the power cord is essential for safe operation.

Use the Proper Power Cord

Use only the power cord and connector specified for your product. Use only a power cord that is in good condition. Refer cord and connector changes to qualified service personnel.

Use the Proper Fuse

To avoid fire hazard, use only the fuse having identical type, voltage rating, and current rating characteristics. Refer fuse replacement to qualified service personnel.

Do Not Operate in Explosive Atmospheres

To avoid explosion, do not operate this product in an explosive atmosphere.

Installation Safety Summary

Safety Precautions

For all product installation procedures, please observe the following important safety and handling rules to avoid damage to yourself and the equipment.

To protect users from electric shock, ensure that the chassis connects to earth via the ground wire provided in the AC power Cord.

The AC Socket-outlet should be installed near the equipment and be easily accessible.

Unpacking and Inspection

Before opening product shipping box, inspect it for damage. If you find any damage, notify the shipping carrier immediately for all claims adjustments. As you open the box, compare its contents against the packing slip. If you find any shortages, contact your sales representative.

Once you have removed all the components from their packaging and checked that all the listed components are present, visually inspect the system to ensure there was no damage during shipping. If there is damage, notify the shipping carrier immediately for all claims adjustments.

Site Preparation

The environment in which you install your product should be clean, properly lit, free from static, and have adequate power, ventilation, and space for all components.

Chapter 1 Your Product

1.1 Product Overview

Q16pro adopts a high-performance video image processing system with a pure hardware wire-speed processing architecture, which is suitable for education and scientific research, government announcements, information publishing, administrative management, military command, exhibitions, security monitoring, commercial sales and other industries.

The modular input and output card structure is adopted, and the arbitrary mixing function of the input card is realized at the same time. Not only can it easily access the common HDMI/DVI/VGA/SDI and other multiple signals, but also support DP 1.2, HDMI 2.0 and other ultra-high resolution 4K/8K signal input and output, easily realize 4K multi-screen point-to-point splicing.

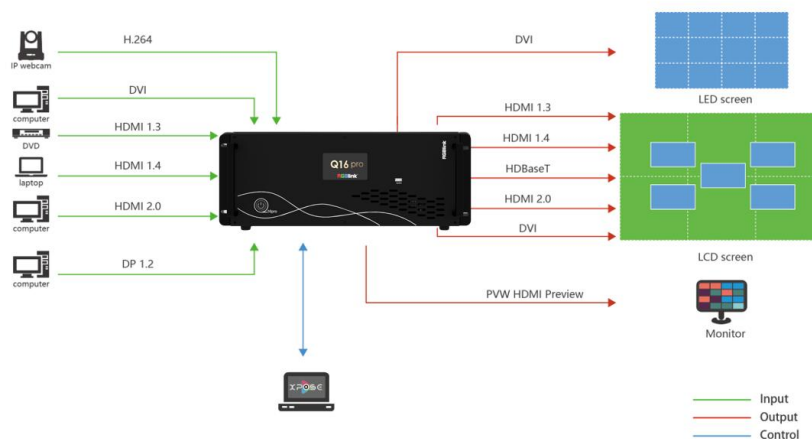

Q16pro SYSTEM CONNECTION DIAGRAM

1.2 Key Features

- Each module support 8 screens spanning the output port without occupying layers
- 12 bit input and output, RGB 4: 4: 4 color space
- Dual independent OSD rolling subtitles
- Multi-window monitoring for inputs and outputs
- i signal output supported
- LOGO overlay
- Seamless switch between signals and scenes
- Dual power module backup

1.3 Front Panel

Q16pro Gen2 4U

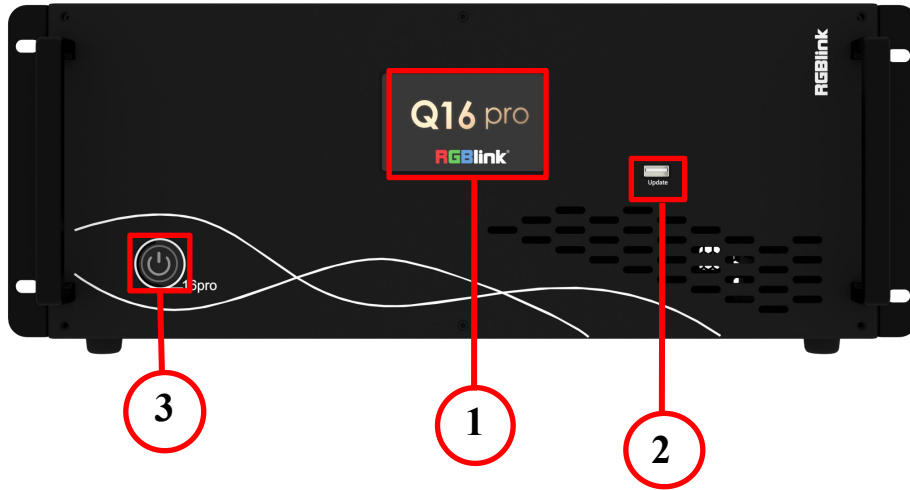

No.	Name	Description
1	LCD Touch Screen	For status monitoring and menu operation
2	USB Port	For device upgrade
3	Power Switch	To turn on/off device

1.3.1 Main Menu

After powered on, the LCD touch screen will show LOGO and then enter the main menu. **Main Menu includes: Device, Settings, Load, Upgrade, Language and Version.**

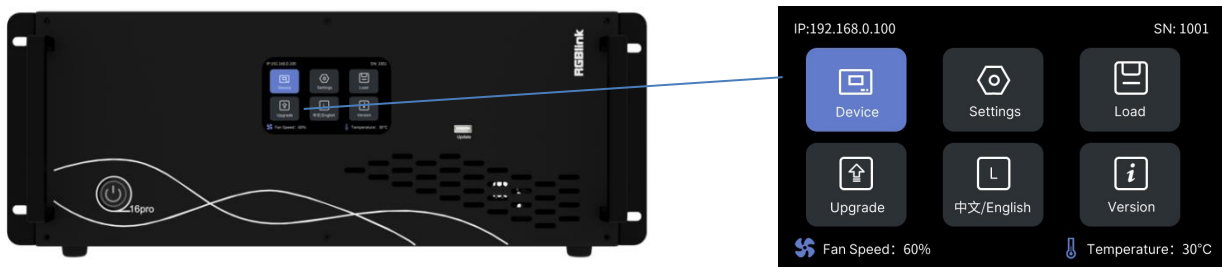

1.3.1.1 Device

Click [**Device**], the LCD screen will show the rear panel of Q16pro.



Green indicates there is a signal plug in. Grey indicates no signal for this port.

1.3.1.2 Settings

Click [**Settings**] to enter the page, which includes Communication Settings, Fan Control, Factory Reset.

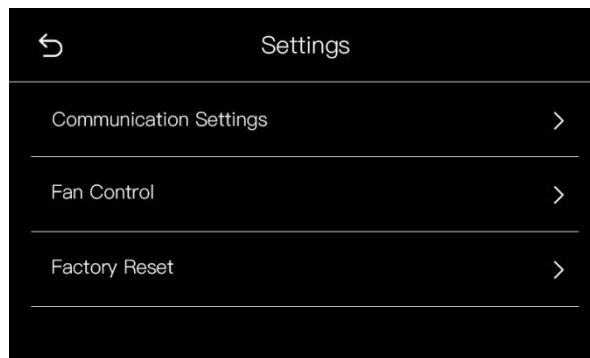

Communication Settings



Click [**Communication Settings**] to do settings of IP and Serial Communication.

IP Settings: Display IP address of the device by default. You can turn off DHCP to manually set the IP address, subnet mask and gateway. Then click [Save] on the right corner to save parameters.

Serial Communication:

COM Port: default COM port. If connected, it will show "Connection".

Baud Rate: default data: 115200

Data Bits: 8

Stop Bits: 1

Parity: None

Fan Control

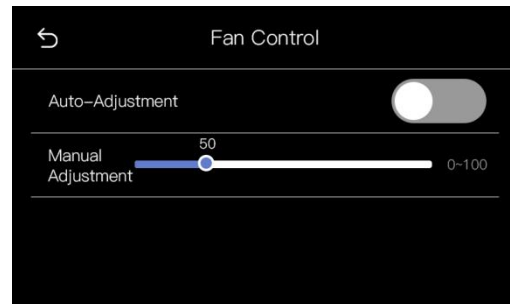
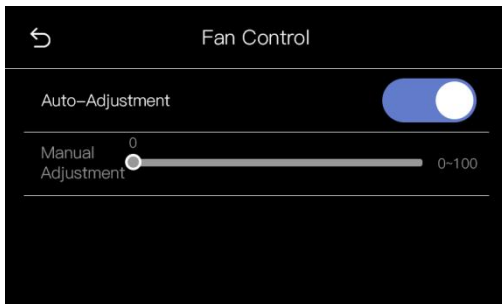

Click [**Fan Control**] to do settings of fan speed. Two modes are optional. The default mode is Auto-Adjustment Mode. If you need to manually control the fan speed, please turn off the Auto-Adjustment Mode to adjust the fan speed.

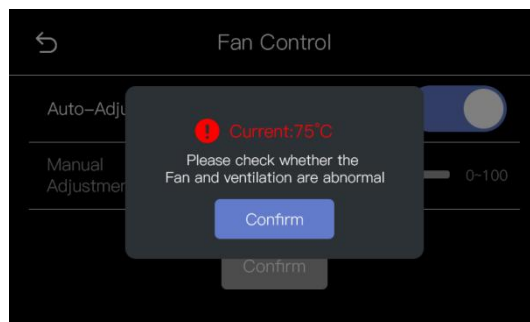

If the temperature of the device exceeds 70°C, a prompt will pop up on the LCD screen as shown above.

Factory Reset



Click [**Factory Reset**] to enter the interface. In this interface, you can choose to Reset IP or Reset EDID. You can also choose to Reset both EDID and IP if necessary.

After clicking [Confirm], the LCD screen will prompt "Resetting, please do not power off" during the process; After reset is completed, the screen will display "Reset completed, please restart device", as shown below:



1.3.1.3 Load

Click [**Load**] to enter the interface of load bank.

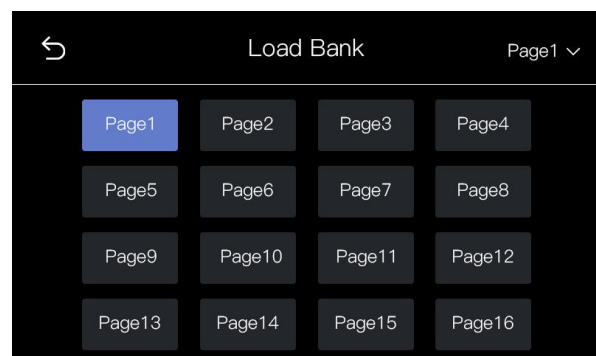
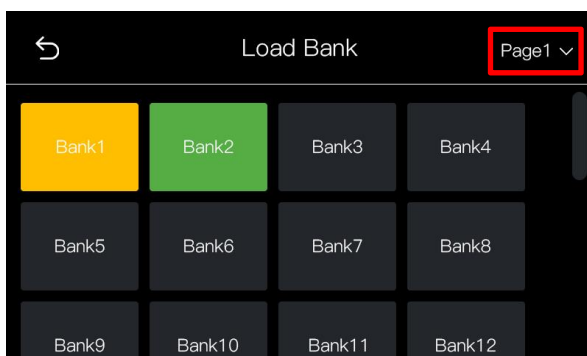

Page: 16 pages optional

Bank: 16 banks in each page. Yellow background: current bank; Green background: with parameter saved; Grey background: empty bank

When the user selects the desired bank, the interface will pop up "Do you want to Load Bank X", shown as below. Click [Confirm] to do the selection.

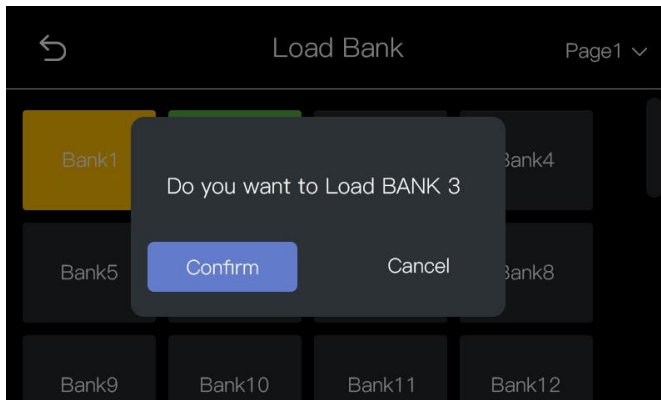

Note: Please do Scene Setting in XPOSE firstly and then you can load bank. (Please refer to 3.2.6 Preset Management)

1.3.1.4 Upgrade

Click [**Upgrade**] to enter the interface for device upgrade.

If no USB disk is inserted, the interface will prompt the user to insert the USB disk for upgrading.

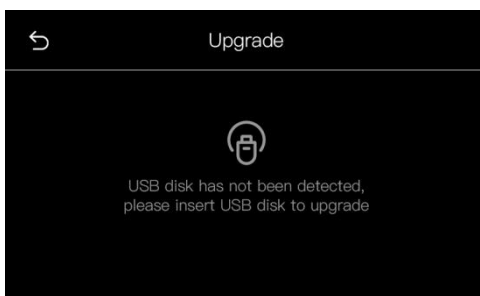

If the user has inserted the USB disk, the interface will pop up a prompt for device upgrade. If the user selects "Confirm", the interface will start upgrading and show the progress bar.



After upgrade is completed, the interface will pop up a prompt to restart the device. Click [Confirm] to restart.

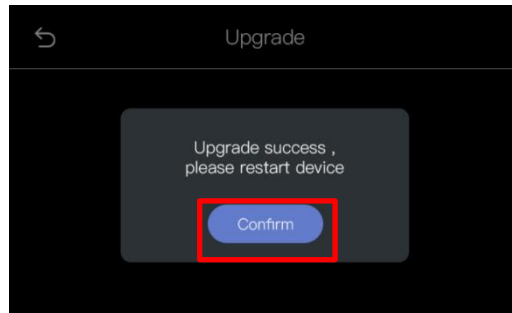

1.3.1.5 Chinese/English

Click [**Chinese/English**] for language switching. Chinese and English are available.



1.3.1.6 Version

Click [**Version**] for overview of version info. The version of communication board, input boards and output boards will be shown in this interface.

The screenshot shows a dark-themed interface with a back arrow in the top left and the title 'Version Info.' in the top center. Below the title is a table with three columns: 'Communication Board', 'Input Board', and 'Output Board'. The table contains five rows of data.



Communication Board	Input Board	Output Board
V1.1.0	V1.1.0	V2.45
-	V1.1.0	V2.45
-	V1.1.0	V2.45
-	V1.1.0	V2.45
-	V1.1.0	V2.45

1.4 Rear Panel

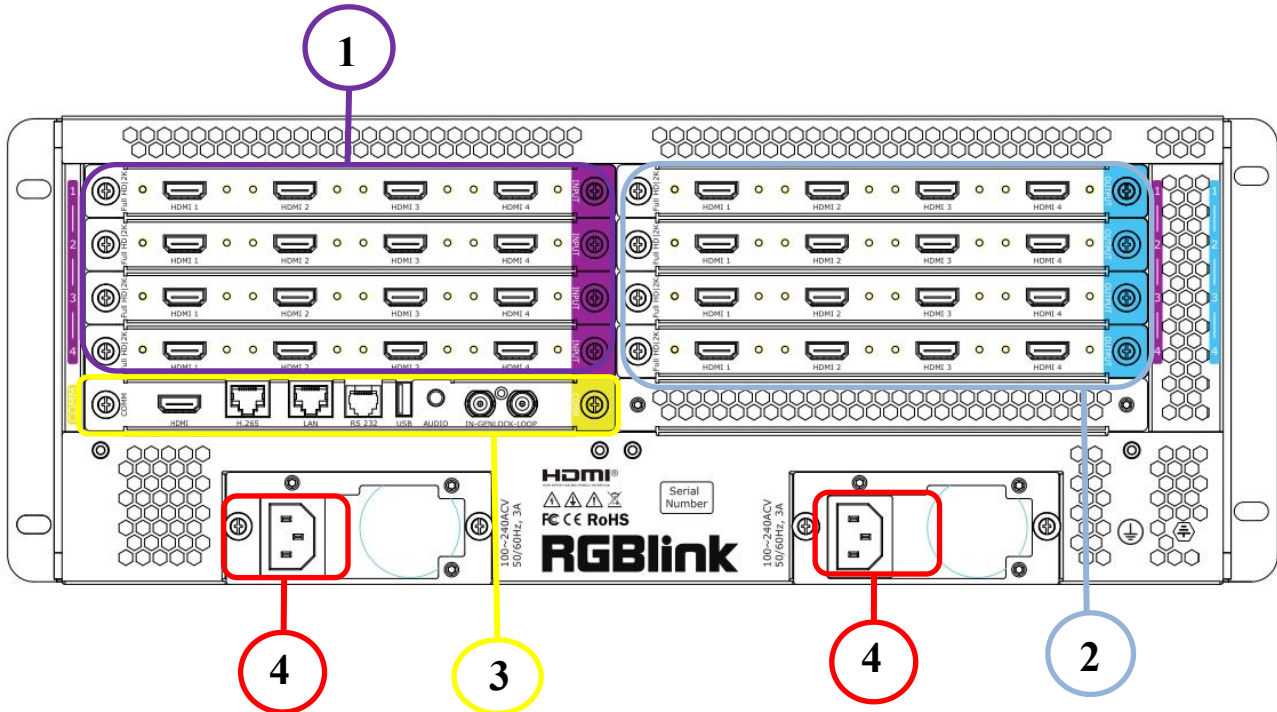
Q16pro Gen2 4U



No.	Name	Description
1	Input Modules 1-4	<ul style="list-style-type: none"> •Support HDMI, DVI, SDI, HDBaseT and other optional input modules.
2	Output Modules 1-4	<ul style="list-style-type: none"> •Support HDMI, DVI, SDI, HDBaseT and other optional output modules. •Support input modules.
3	Communication Module	<ul style="list-style-type: none"> •PVW (HDMI port) input port for multi-window monitoring •IP module (H.265 port) for remote control and IP echo. •TRS port for audio monitoring. •Ethernet port for connecting to router or control PC to realize software control or for device upgrade. •RS232 port for connecting router or control PC to realize software control. •USB port for device upgrade. •IN-GENLOCK-LOOP for connecting to a synchronization signal; IN is used to accept the sync signal; LOOP is used to loop the sync signal.
4	Power Module	2U (to be published) supports single power supply, 4U and above supports double power supply module.

Note:  purple tip indicates input,  blue tip indicates output,  yellow tip indicates communication.

1.5 Dimension

Q16pro Gen2 2U

Dimension of Q16pro Gen2 2U: 483mm x 377mm x 89mm

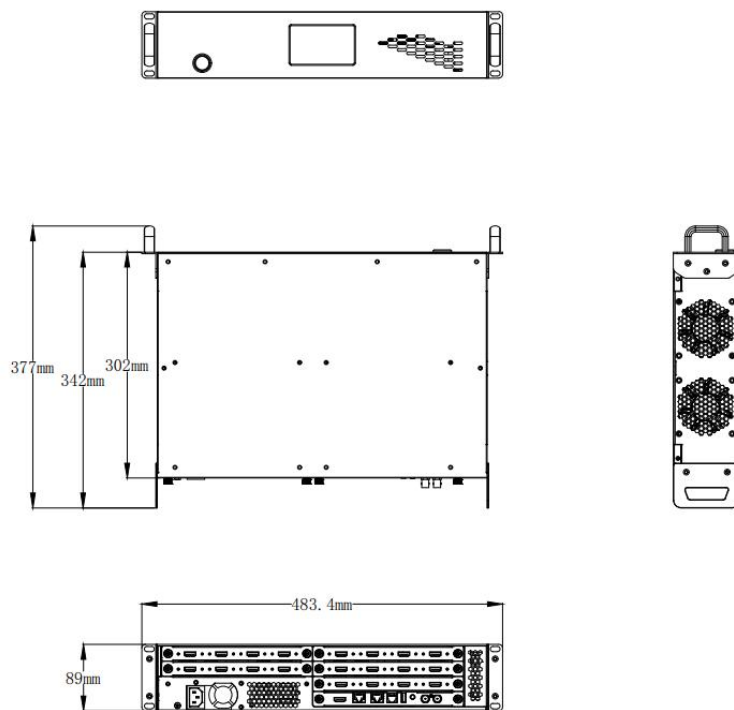

Q16pro Gen2 4U

Dimension of Q16pro 4U: 483mm x 376mm x 178mm

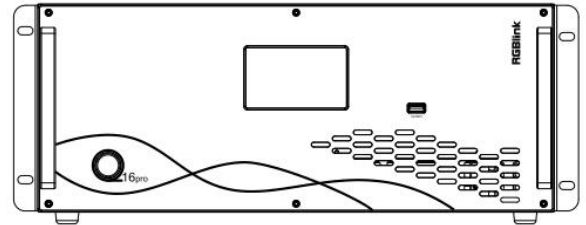
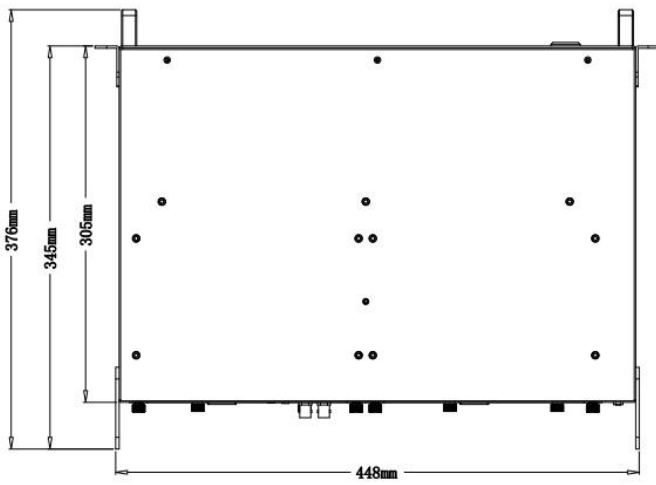
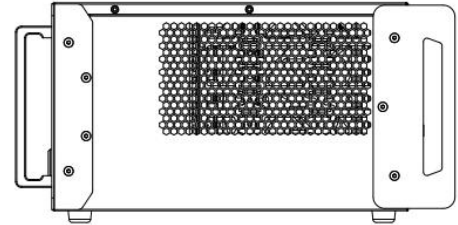
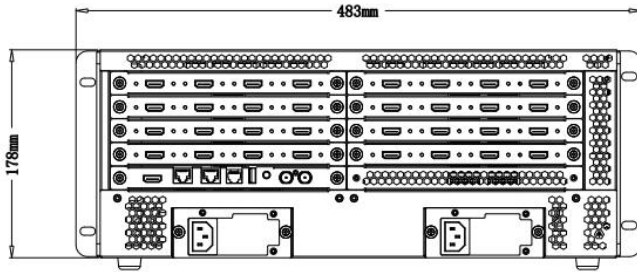

Chapter 2 Install Your Product

2.1 Plug in Power

This chapter takes Q16pro 4U as the example. Other models are also applicable to operations in this chapter.

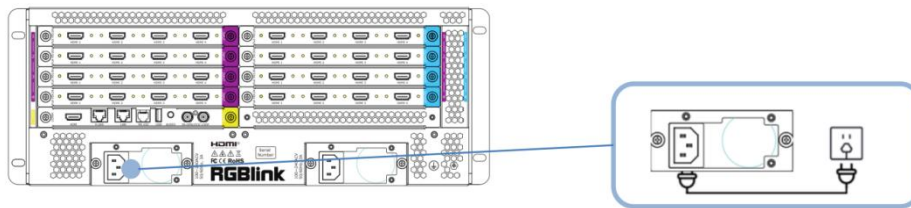

Connect power and Q16pro 4U with standard AC Power Cord.

2.2 Connect Signal Source and Control Computer

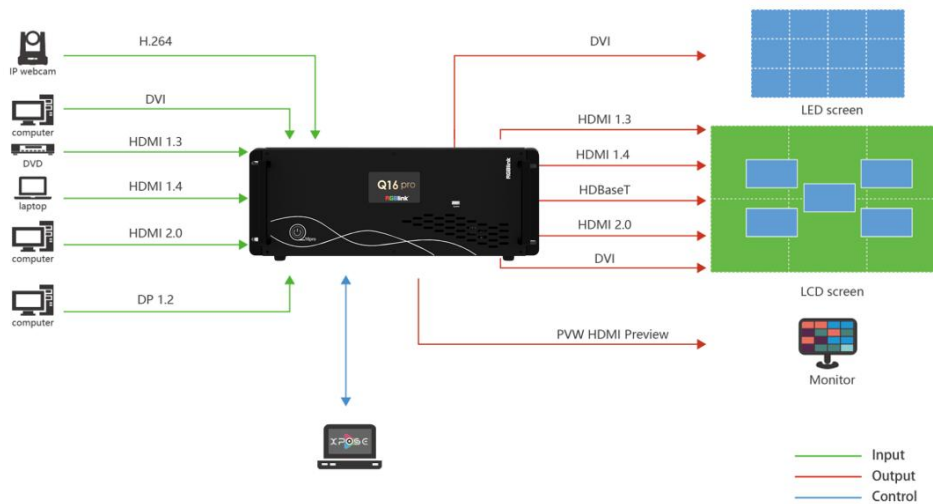

Q16pro supports HDMI, DVI, HDBaseT and other optional input and output modules.

Connect Q16pro 4U with Camera, PC, laptop and other device as shown in the figure above.

Q16pro is operated by XPOSE, so it is necessary to connect device with control computer.

Method 1: Direct Connection: Do direct connection via communication connection or serial connection. It is suitable for single user to control the device.

Method 2: Router Connection: Connect control computer and Q16pro 4U with Router as shown in the figure above. It supports simultaneous online operation by multiple users.

2.3 Turn on Your Product



After connection, slightly press the power button in the front panel to turn on Q16pro.





Chapter 3 Use Your Product

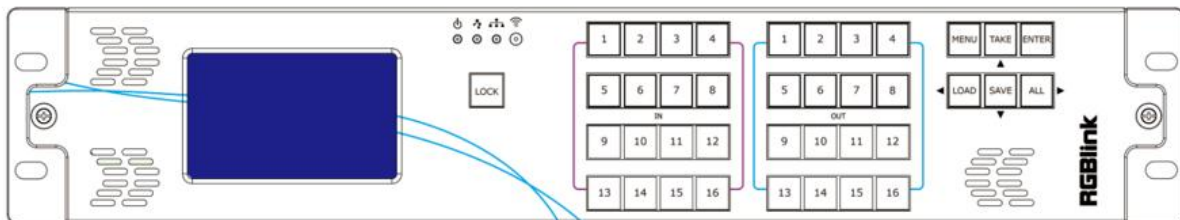

3.1 CPX Controls Q16pro

3.1.1 CPX Front Panel





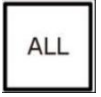
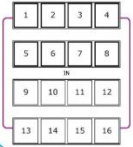
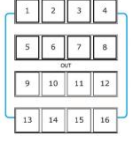

Users can refer to the following table for more details of button operation.

Description	
	LCD panel for menu operation
	<p>1.Light ON indicates other buttons are available; Light OFF indicates other buttons are locked.</p> <p>2.LOCK is OFF by default, push and hold the LOCK button to enable or disable other buttons.</p>
	<p>1.Push MENU button to enter main menu interface for more functions.</p> <p>2.Used as BACK button to return to the previous interface in sub-menu.</p>
	<p>1.Push to save presets in Scene Switch Mode.</p> <p>2.Used as direction key "Up" in menu interface.</p>
	<p>1.Push ENTER button to trigger Switch Mode in standby mode; In Switch Mode, press OUT 1-16 to select a group of synchronized output ports and then press IN 1-16 to synchronize the input to the selected output ports.</p> <p>ENTER Light on if Switch Mode is triggered. Push ENTER button again to return to Matrix Mode. (more details please refer to 3.1.4.3 Switch Mode)</p> <p>2.Used as confirm button under menu operation.</p>

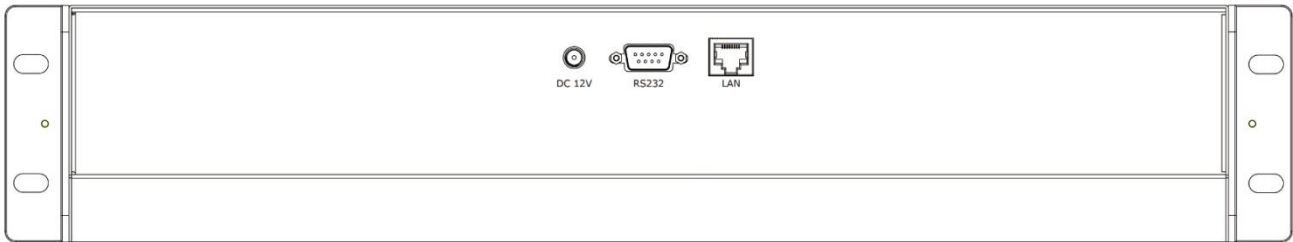
	<p>1.Push LOAD button to trigger Scene Switch Mode in standby mode. Press OUT 1-16 to load saved presets. (Notice: only ONE scene can be selected at the same time)</p> <p>LOAD Light on if Scene Switch Mode is triggered. Push LOAD button again to return to Matrix Mode. (more details please refer to 3.1.4.4 Scene Switch Mode)</p> <p>2.Used as direction key “Left” under menu operation.</p>
	<p>1.Push SAVE button to trigger OSD Mode in standby mode. Press IN 1-16 to load OSD 1 or OUT 1-16 to load OSD 2 to selected output port.</p> <p>SAVE Light on if OSD Mode is triggered. Push SAVE button again to return to Matrix Mode. (more details please refer to 3.1.4.2 OSD Mode)</p> <p>2.Used as direction key “Down” under menu operation.</p>
	<p>1.Default to enter the Matrix Mode after power on.</p> <p>2.Initial state: All input and output button lights are OFF. Users need to choose one input button first and then the corresponding output button light will be ON. Users can press other output buttons for matrix switch.</p> <p>3.Non-initial state (matrix has been switched): One input has been selected, and the corresponding output button light is ON. Users can press other output buttons for matrix switch.</p> <p>4Used as direction key “Right” under menu operation.</p>
	<p>1. Indicate Input Ports 1-16 under Matrix Mode and Switch Mode.</p> <p>2. Indicate Page 1-16 under Scene Mode.</p> <p>3. Press IN 1-16 to load OSD 1 to selected output port under OSD Mode.</p>
	<p>1. Indicate Output Ports 1-16 under Matrix Mode and Switch Mode.</p> <p>2. Indicate Scene 1-16 under Scene Mode.</p> <p>3. Press OUT 1-16 to load OSD 2 to selected output port under OSD Mode.</p> <p>4. Used as Numeric Keys under menu control; 1-9 indicate number 1-9, 10 indicates number 0.</p>

3.1.2 CPX Rear Panel



Description	
 DC 12V	DV 12V power socket
 RS232	RS 232 port
 LAN	Connect two Q16pro devices to the same switch, and CPX can control two devices simultaneously.

3.1.3 Connect CPX and Q16pro

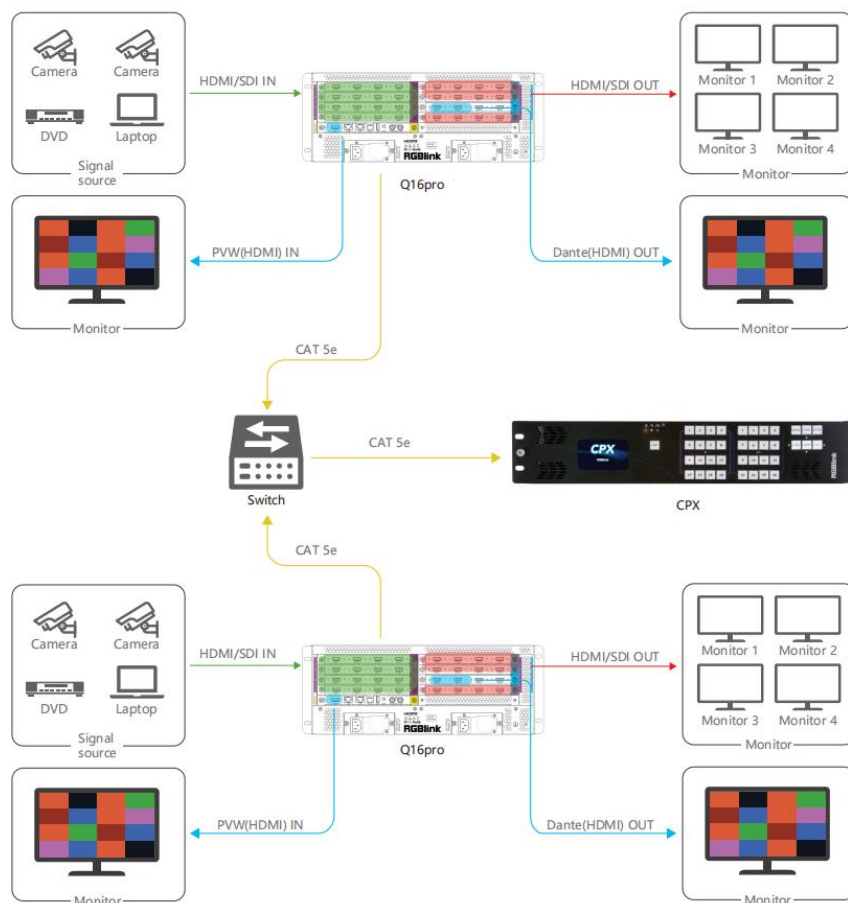

Q16pro supports HDMI, SDI and other optional input and output modules.

Please connect the input signals, such as camera, computer or other device, to the input port of the Q16pro via correct cable; Please connect the output port to monitor via correct cable.

After successful connection, power on Q16pro and CPX. (Use the standard 12V power adapter to connect CPX and power socket in order to boot up CPX.)

User should firstly choose Q16pro as the controlled device.

Push **MENU** button to enter the menu interface, click **Search** and choose Q16pro in **Select Device**.

Please refer to following steps for device selection: **【Menu】 --> 【Search】 --> 【Select Device】 --> 【Q16pro】** .

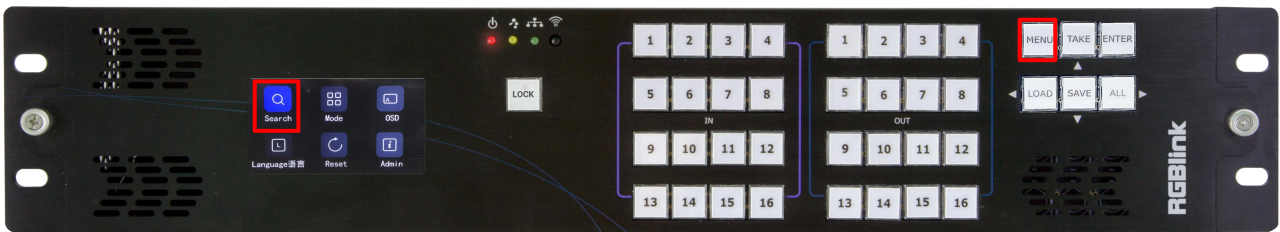

The default IP Address of CPX is 192.168.0.200 and Q16pro is 192.168.0.100.

1. If IP address of Q16pro and CPX have not been modified before, that is, the **IP of CPX and Q16pro are in the same LAN**, you can directly connect CPX and Q16pro via a network cable.
2. If you use Network Communication, and the **IP of CPX and Q16pro are not in the same LAN**, please refer to the following steps to set the IP of CPX and Q16pro to the same LAN for data exchange.

IP Setting Steps: Menu >> Search >> Network Communications >> Local IP (modify CPX IP).

If CPX and Q16pro are in the same LAN, the **Connection** in the upper left corner will show **Connected** after successful communication connection.

3. You can also achieve **control of multiple devices** at the same time by using a switch.

3.1.4 Use Function Keys

CPX will enter Matrix Mode by default after booted up. You can use function keys **[ALL]**, **[SAVE]**, **[ENTER]**, **[LOAD]** for more operations.

3.1.4.1 Matrix Mode

CPX shows LOGO and then automatically enters Matrix Mode. The LCD screen displays the current status.

Under Matrix Mode, **[ALL]** key is on, as shown in the figure below.

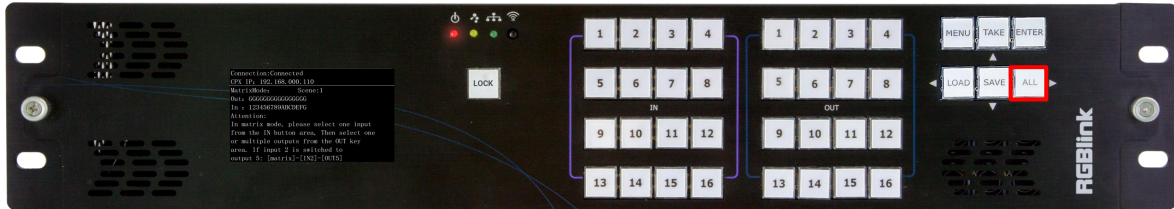
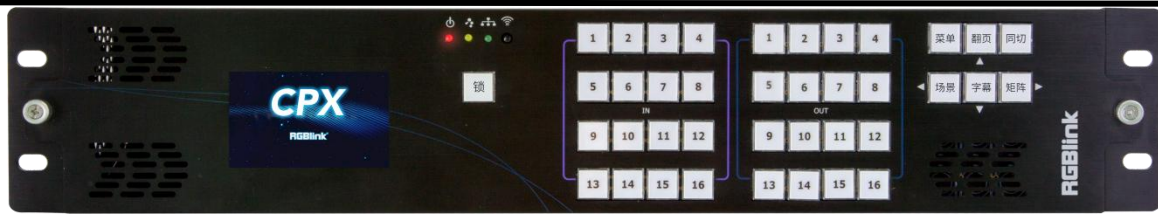

In Matrix Mode, you can select input signal from [IN 1-16] and output signal from [OUT 1-16].

Example 1: Switch input 1 to output 5 (Input signal 1 not been used in any output ports before.)

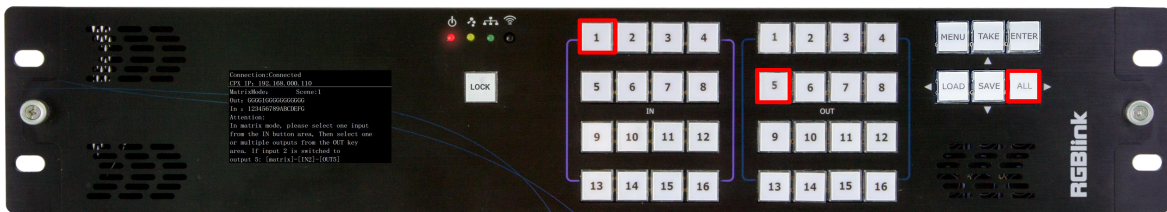

Step 1: Select [IN 1] and the light will be ON to indicate that the input signal 1 has been selected.

Step 2: Select [OUT 5], [OUT 5] light will be ON and the output port 5 will display input signal 1. The input and output relationship will change accordingly on LCD screen.

Example 2: Switch input 1 to output 7 and output 8 (Input signal 1 been used in output port 5 already.)

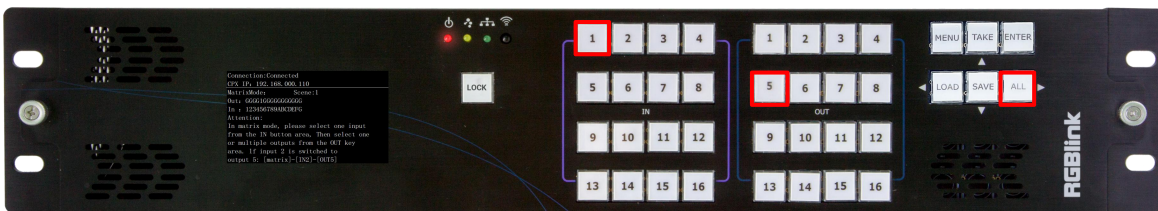

Step 1: Press [IN 1] and CPX auto detects the matching relationship set before. That is, lights of [IN 1] and [OUT 5] will be ON after number [IN 1] is pressed because Input signal 1 has been used in output port 5 in example 1.

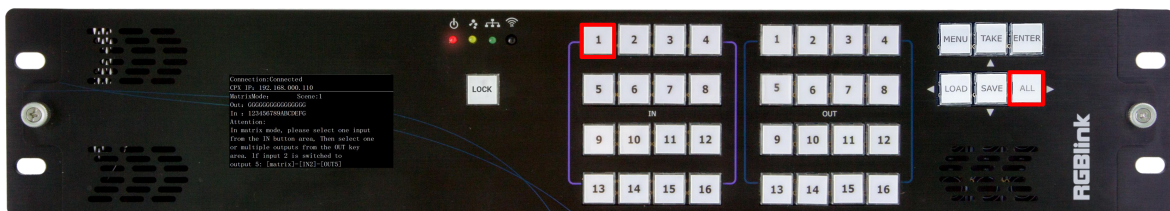

Step 2: Now press [OUT 5] to stop displaying input signal 1 on output port 5. Light of [OUT 5] will be OFF.

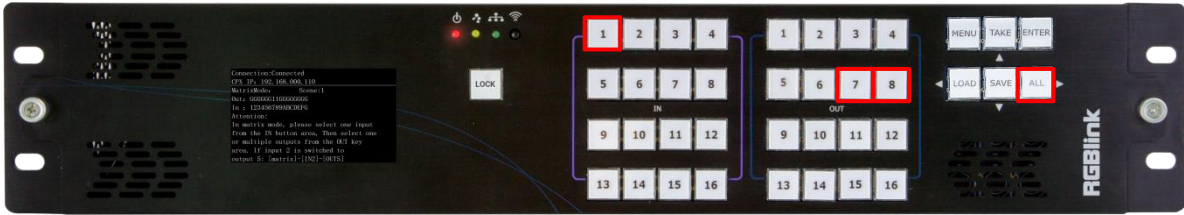

Step 3: Press [OUT 7] and [OUT 8] and lights will be ON. Input signal 1 has been used on output port 7 and 8.

User can check input and output relationship shown on CPX screen to ensure successful signal exchange.

3.1.4.2 OSD Mode

Press [SAVE] key on the panel to enter **OSD Mode** and the light of [SAVE] is ON.

In OSD Mode, users can use numeric key [IN 1-16] to load **OSD 1** to output ports 1-16; and [OUT 1-16] to load **OSD 2** to output ports 1-16.

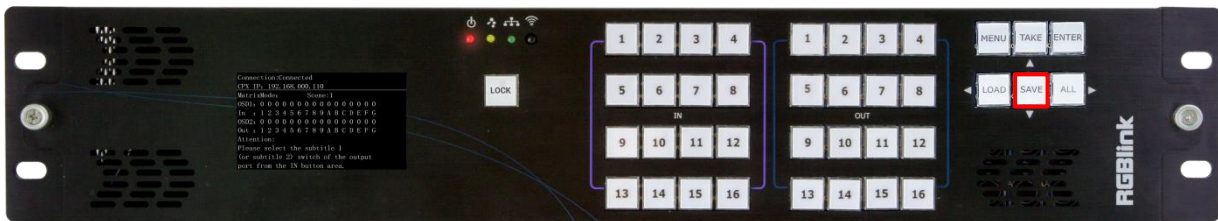

Press [SAVE] key and CPX will automatically detect the relationship between OSD and corresponding output ports.

As shown in the figure below, OSD 1 has been called on output 3, OSD 2 has been called on output 5. Therefore, lights of [IN 3] and [OUT 5] are on.

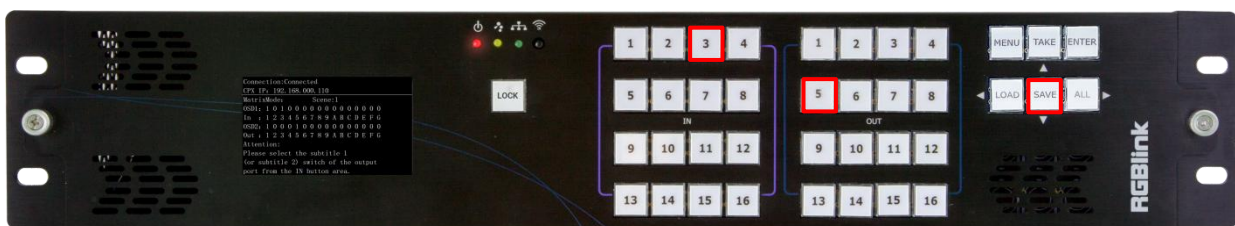

Example: If the user needs to load OSD 1 on the output port 10 and OSD 2 on the output port 12, the following steps can be followed.

Step 1: Press [IN 10] and the light will be on to indicate OSD 1 has been loaded on output port 10.

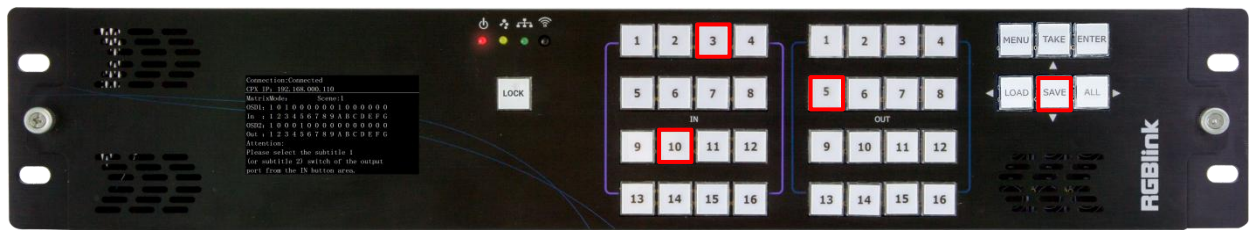

Step 2: Press [OUT 12] and the light will be on to indicate OSD 2 has been loaded on output port 12.

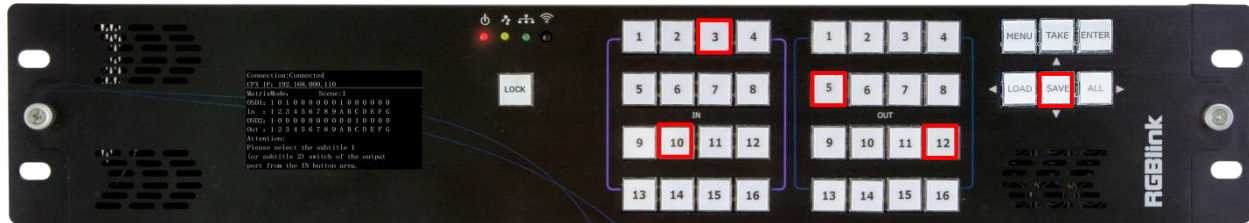

3.1.4.3 Switch Mode

Press [ENTER] key on the panel to enter **Switch Mode** and the light of [ENTER] is ON.

Assume that in the initial state, output 1, output 3 and output 5 have been selected. Therefore, lights of [OUT 1], [OUT 3] and [OUT 5] are on if [ENTER] key is pressed, as shown in figure below.

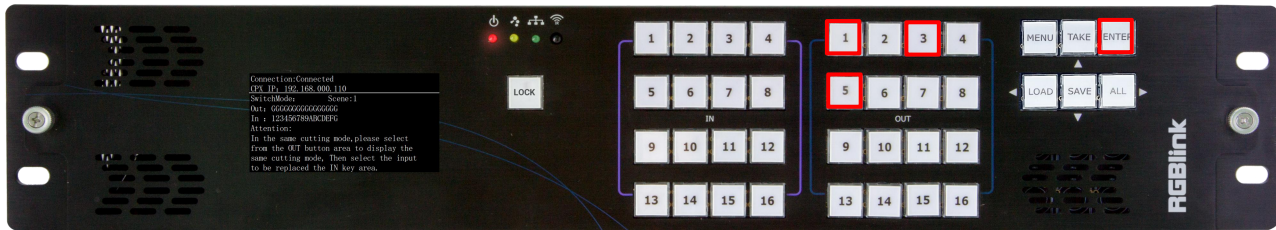

Example: If you want to add [OUT 9], [OUT 12] and [OUT 15] to the synchronous output group, move [OUT 1] out of the group, output [IN 1] to the group firstly and later output [IN 5] to the group, you can take the following steps.

Step 1: Press [OUT 9], [OUT 12] and [OUT 15] to add output signal 9, 12 and 15 to the synchronous output group. Lights will be on after [OUT 9], [OUT 12] and [OUT 15] have been pressed.

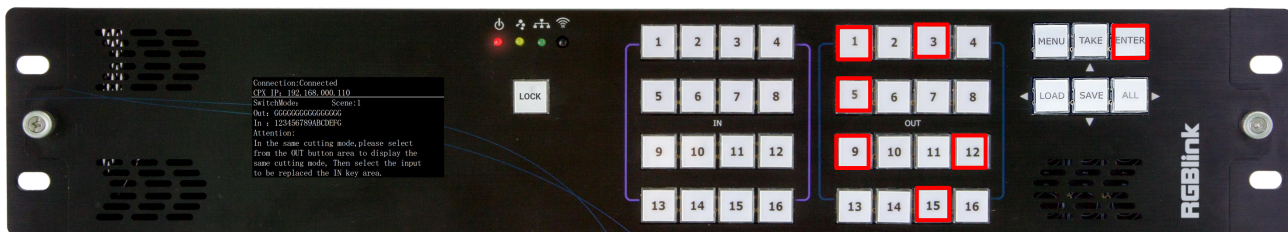

Step 2: Press [OUT 1] to remove output signal 1 from the group. Light of [OUT 1] will turn OFF. (Notice: Suppose that [OUT 1], [OUT 3] and [OUT 5] displayed the signal 8 at first, and [OUT 1] continues to display the signal 8 after been removed from the output group.)

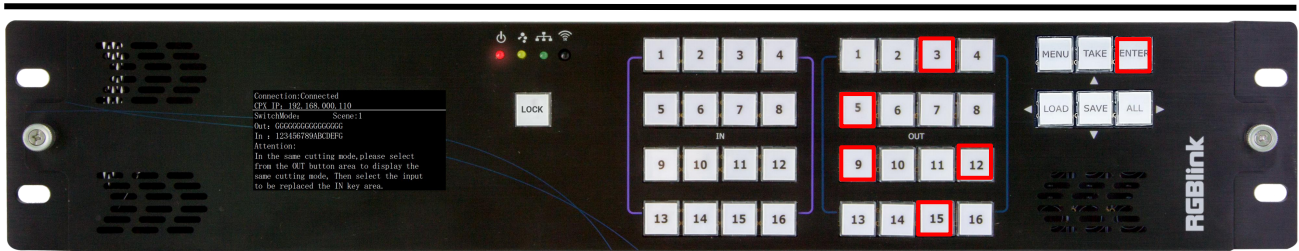

Step 3: Press [IN 1] to output input signal 1 to the set synchronous output group. Light of [IN 1] will be ON.

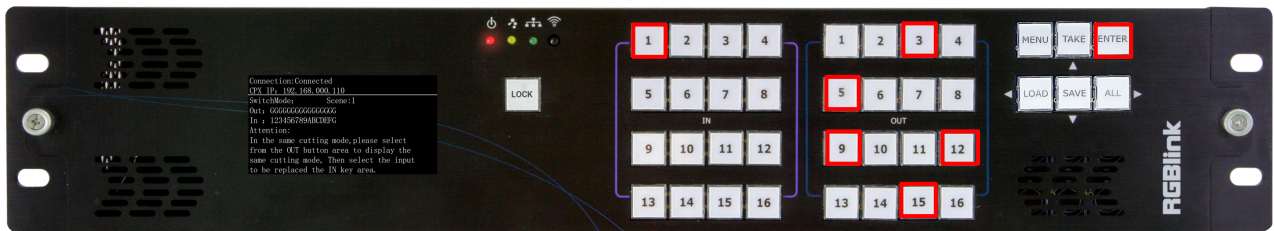

Step 4: Press [IN 5] to switch input signal 5, instead of input signal 1 set before, to the synchronous output group. Light of [IN 5] will be ON.



3.1.4.4 Scene Mode

Press [LOAD] key on the panel to enter **Scene Mode** and the light of [LOAD] is ON.

Press [OUT 1-16] to load saved presets. (Notice: only ONE scene can be selected at the same time)
LOAD Light on if Scene Switch Mode is triggered. Push LOAD button again to return to Matrix Mode.

Example 1: The initial status is that no scene has been used before. If you want to enter to scene 1, the following steps can be followed.

Step 1: Press [LOAD] to enter non-saved scene mode, and the light will be on.



Step 2: Press [OUT 1] to load Scene 1.

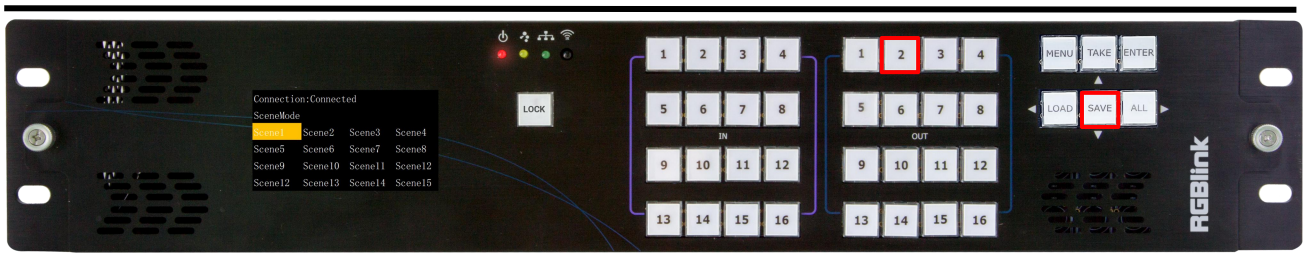

Example 2: The initial status is that the Scene 5 has been loaded. If you want to switch to scene 1, the following steps can be followed.

Step 1: Press [LOAD] to enter non-saved scene mode, and the light will be on.



Step 2: Press [OUT 1] to switch to Scene 1.



Note: If the user needs to save a new scene, press [TAKE] button after input-output relationship has been set .
 Example: If you want to save the preset to Scene 2, press [OUT 2] button and then the [TAKE] button to complete the operation.

3.1.5 Use Main Menu

Six parts are built in Main Menu, which include [Search], [Mode], [OSD], [Language], [Reset] and [Admin].

Under menu operation, [TAKE], [SAVE], [LOAD] and [ALL] are used as **Direction Keys**, which indicate Up, Down, Left and Right respectively; and [Enter] is used as **Confirm Key**.



3.1.5.1 Search

Press MENU to enter main menu interface, choose [Search] to enter the following interface.

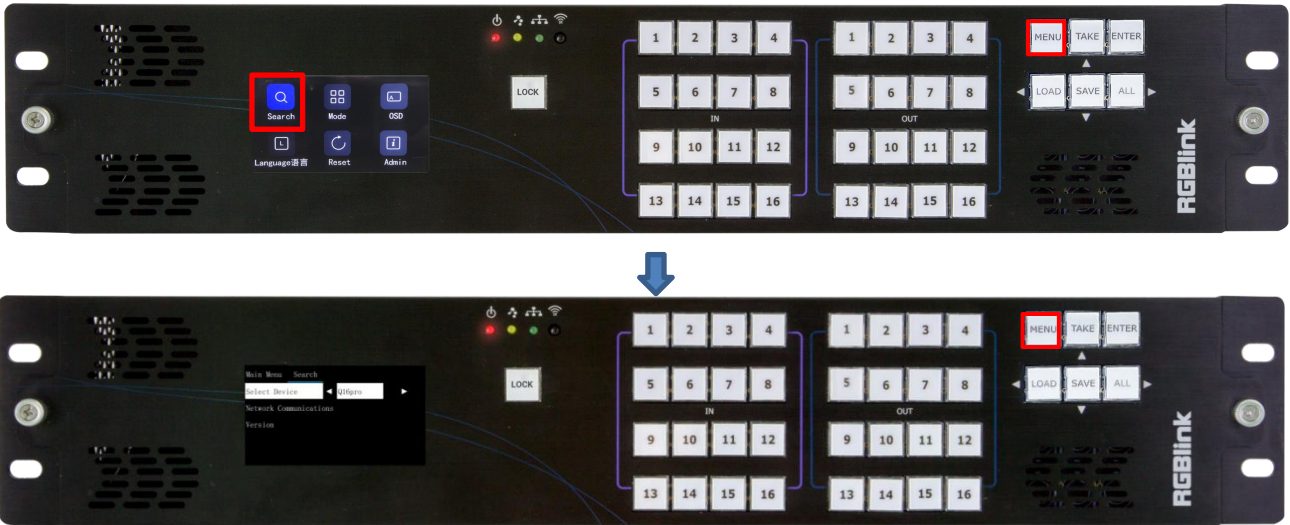

Select Device: Choose device to be controlled, such as Q16pro.

Network Communications

Network Communications: User can perform operations like IP check or IP modification of CPX in this interface. If IP modification is needed, please press the [ENTER] key firstly. * mark indicates IP address is currently editable. You can key in numbers in [OUT 1~16] area for IP Modification.

Device 1/2 IP: User can perform operations like IP check or IP modification of Q16pro in this interface. If IP modification is needed, please press the [ENTER] key firstly. * mark indicates IP address is currently editable. You can key in numbers in [OUT 1~16] area for IP Modification.

Version: Check version of CPX and controlled device.

3.1.5.2 Mode

Press MENU to enter main menu interface, choose [Mode] to enter the following interface.

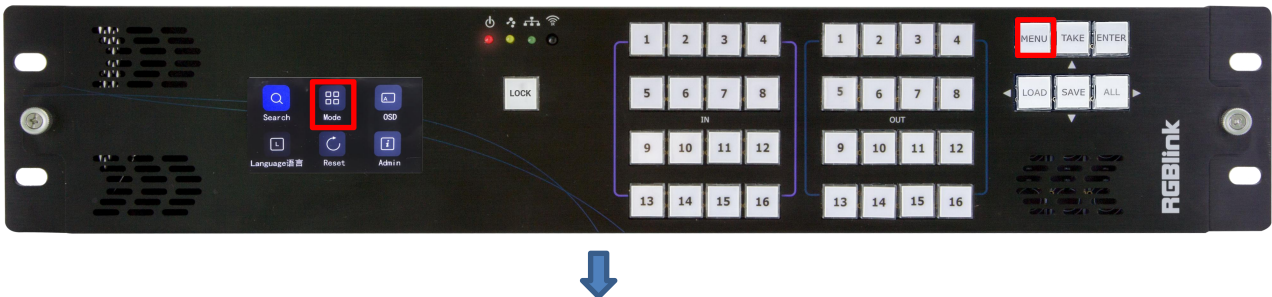

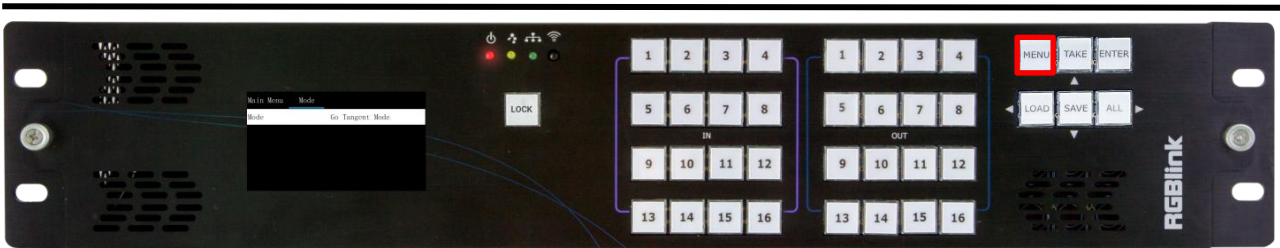

In this interface, user can choose **Matrix Mode**, **Switch Mode** or **Scene Mode** to meet various requirements.

Matrix Mode: Select one input signal from [IN 1-16] and then select one (or above) output signal from [OUT 1-16]. For example, if you need to switch input signal 2 to output signal 5, please do as follows: [Matrix Mode] -[IN 2] - [OUT 5].

Switch Mode: Select multiple output ports that need to display the same signal from [OUT 1-16], and then select the input signal from [IN 1-16].

Scene Mode: [IN 1-16] indicate Page 1-16 and [OUT 1-16] indicate Scene 1-16. Press [LOAD] button to enter Page 1 by default. For example, If you need to switch Scene 1 on Page 2, please do as follows: [LOAD]-[IN 2]-[OUT 1].

3.1.5.3 OSD

Press MENU to enter main menu interface, choose [OSD] to enter the sub-menu.

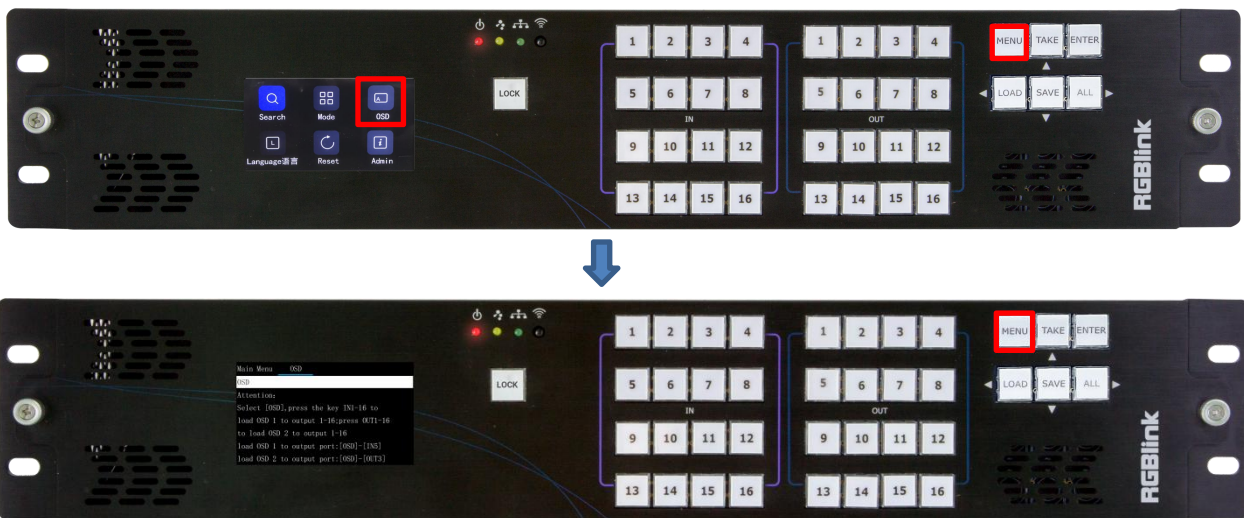

User can click output port 1-16 to check matching relationship between outputs and OSD.

3.1.5.4 Language

Press MENU to enter main menu interface, choose [Language 语言] to switch language.

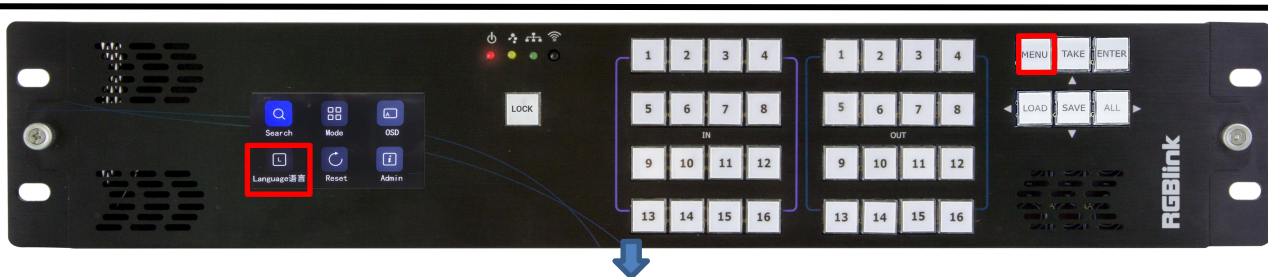

English Chinese are available. If you choose English, just select English and then press [ENTER] key to confirm, the user interface will automatically switch to from Chinese to English.

3.1.5.5 Reset

Press MENU to enter main menu interface, choose [Reset] to restore the device configuration to the default parameters.

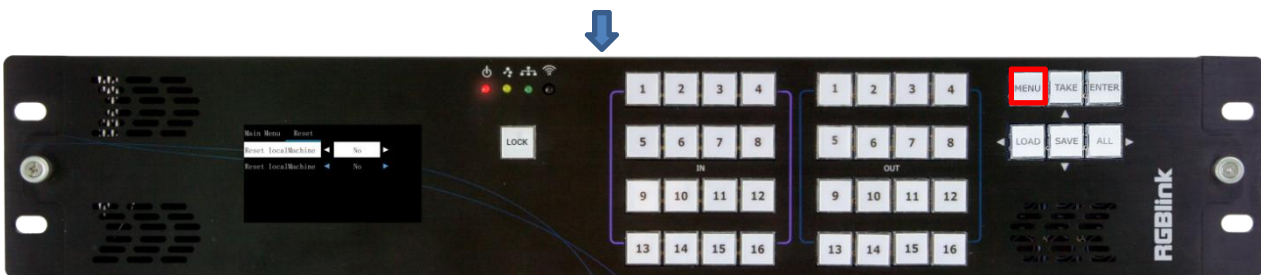
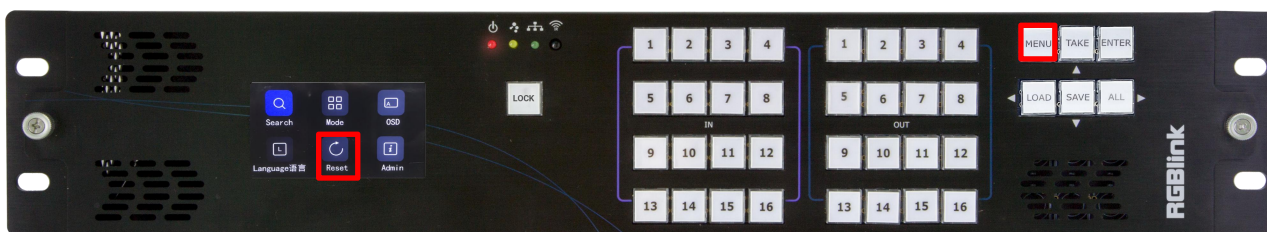

Reset Local Machine and Target Machine: Reset information of CPX and controlled device (such as Q16pro)

Reset Local Machine: Reset information of CPX only.

⚠ Notice: All parameters will be restored to default parameters, which include but not limited to device IP, EDID, preset scenes, etc.

3.1.5.6 Admin

Press MENU to enter main menu interface, choose [Admin] to set output resolution and preview mode.

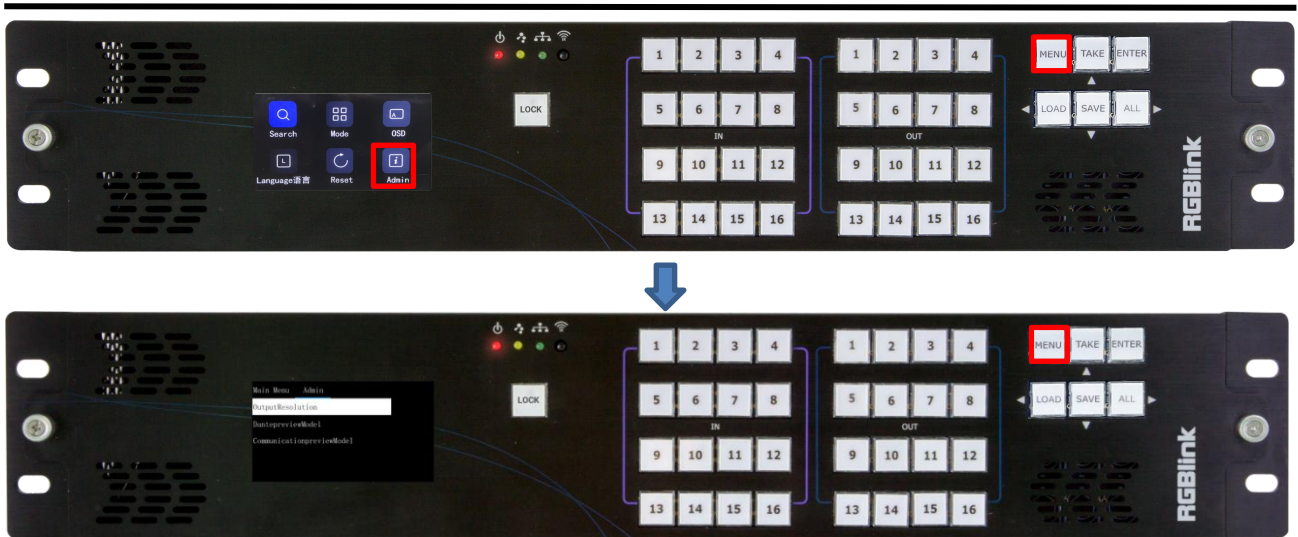

Output Resolution

Global Resolution: to set output resolution of all output modules to be the same.

Independent Resolution: to set the resolution according to different output modules.

Resolution can choose from: 1024×768@50, 1280×720@60, 1280×720@50, 1280×800@60, 1280×1024@60, 1360×768@60, 1366×768@60, 1400×1050@60, 1440×900@60, 1600×1200@60, 1680×1050@60, 1920×1080@60, 1920×1080@30, 1920×1080@50, 1920×1080@50i, 1920×1080@60i

Communication Preview Mode: ONLY Preview Input Mode is supported. 4x4, 3x3, 2x2, 2+8, 2+4 layouts for you to choose from.

3.2 XPOSE 2.0 Installation

Note: The following XPOSE operation takes Q16pro 4U as an example, and other models operate the same except for the difference of interface.

Environment Requirements:

Window

Processor: 1 GHz or above 32 bit or 64 bit processor

Memory: 4 GB or more

Graphics: Support Direct X9 128M or above (open AERO effect)

Hard disk space: Above 16G (primary partitions, NTFS format)

Monitor: Resolution must be 1920×1080 pixel or above(it can not display normally if the resolution is lower than 1920×1080)

Operating system: Windows 7 or above (full version, not Ghost version or compact version)

CPU:i5 and above

Mac

Monitor:Resolution must be 1680×1050 pixel or above(it can not display normally if the resolution is lower than 1680×1050)

CPU:i5 and above



1. Double click  ,it will pop-up the installer language box, select the language, for example, select “English”, and click “OK” to confirm.

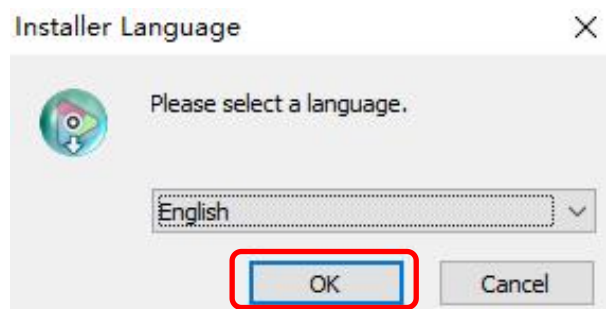

2. Click “Next” to install.

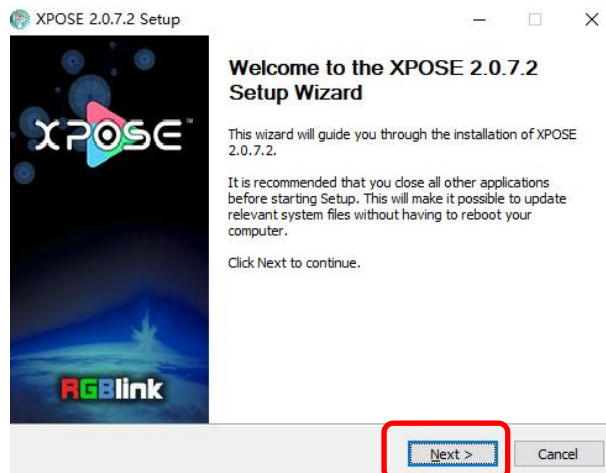

3. Click "Browse..." to select the XPOSE software install location.

Click "Install".

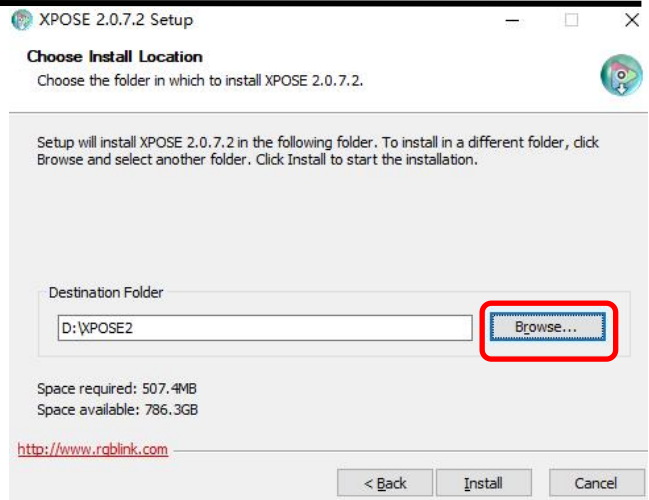

5. During installation, it will pop up the window of Install Shield Wizard for Virtual Com port.

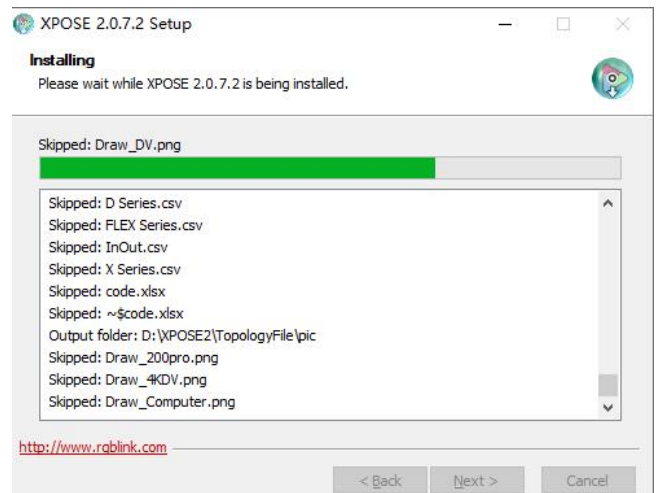

4. Click "Next".

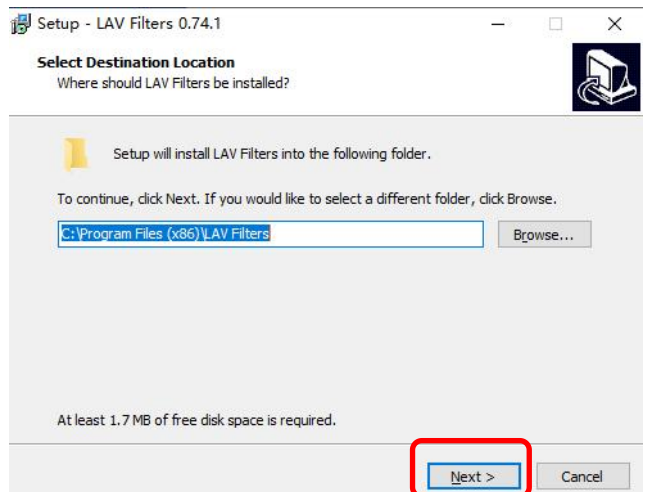

6. Then click "Install", as shown in the figure.

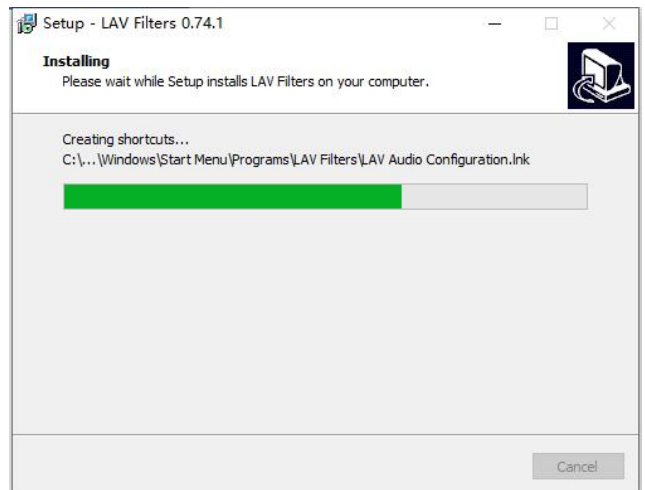
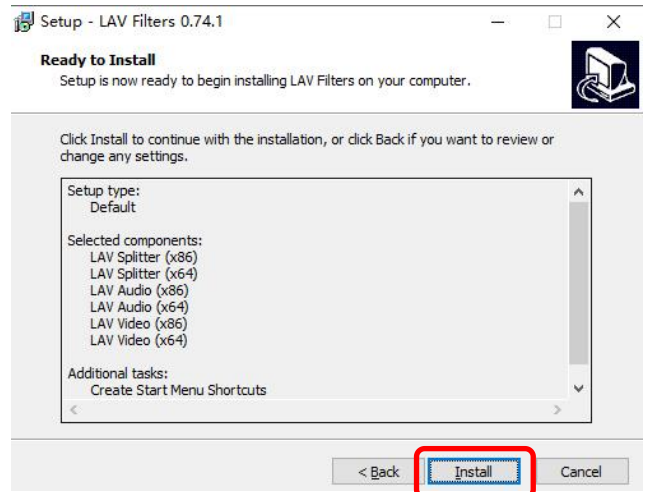

7. Click "Finish" and complete the installation, as shown in the figure below.

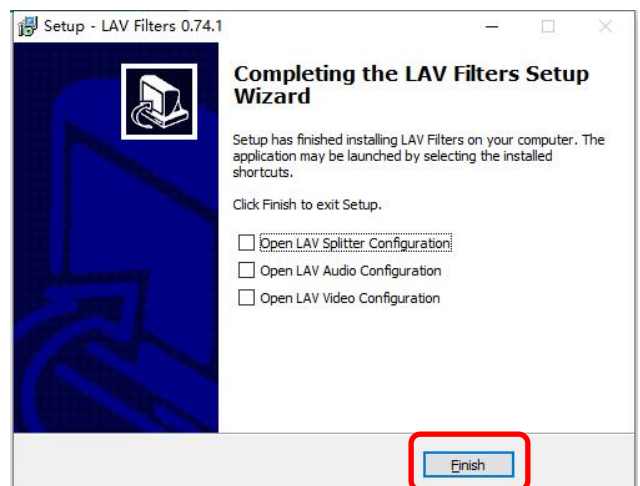

8. Click “Finish” and is ready to run the XPOSE software

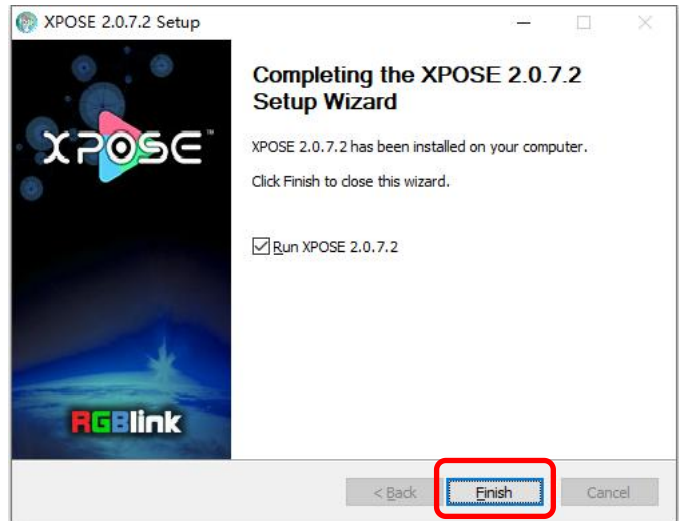

3.3 XPOSE Operation

3.3.1 Login in XPOSE



Double click this icon ,and enter the log on interface shown in the right:

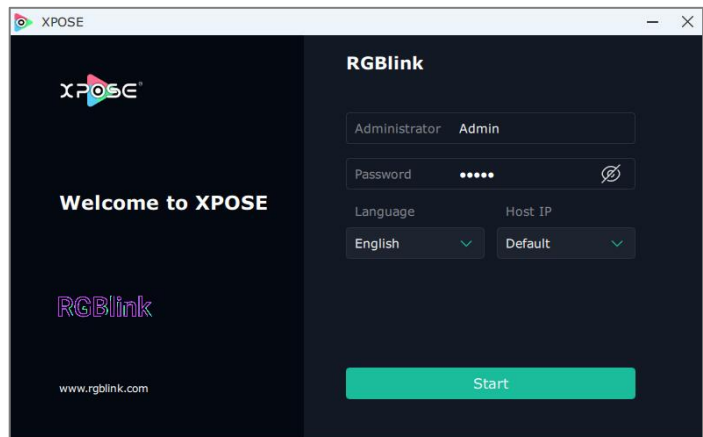

The initial language of XPOSE 2.0 is self adjusted based on the operation system language of the computer.

If you want to change language, just click **Language** and choose one you need.

Keep the user name as “Admin” and password blank and then click **Start**.

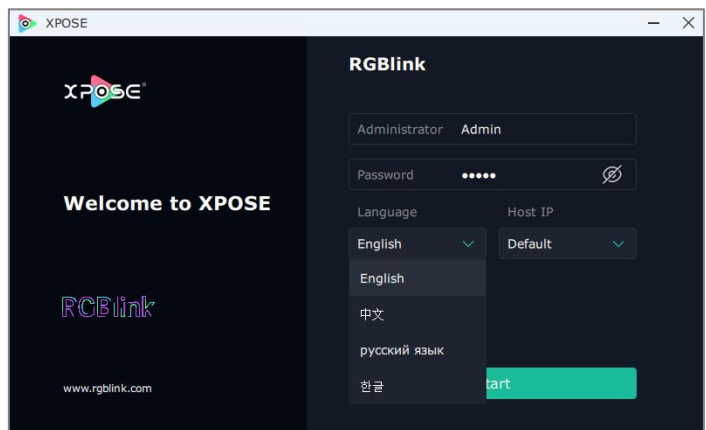

After login,the interface is shown in the right.

Users can find 5 major parts : **System Setting**, **Connect Setting**, **Display Management**, **Layer Management**, **Scenes Management**.

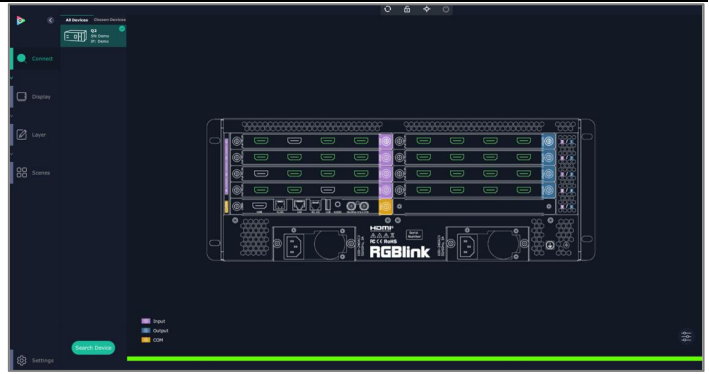

3.3.2 System Setting

Click  to enter <System Setting>interface.

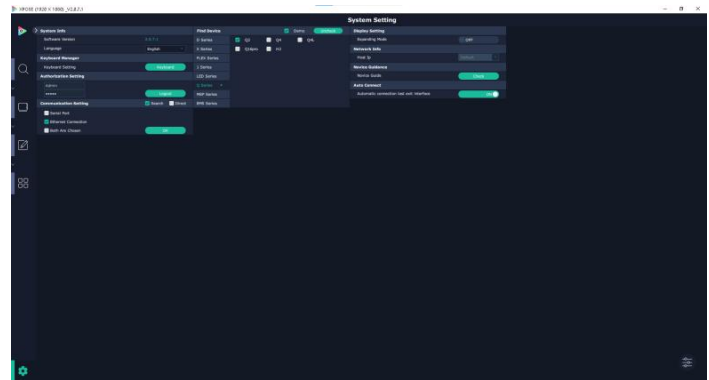

Find Device : New version of XPOSE 2.0 is blank default in Find Device. Users are supposed to choose the device needed in Find Device.

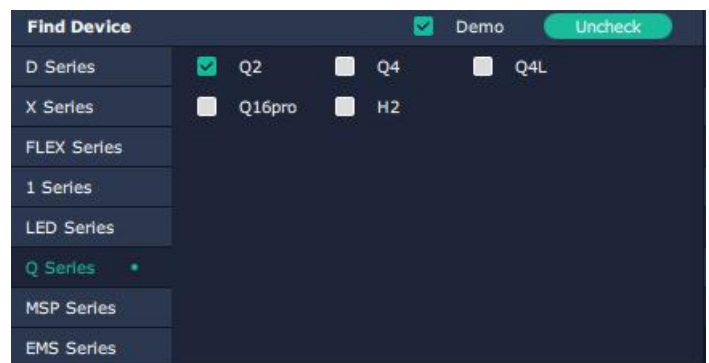

System Info: Check current software version and choose system language you need.

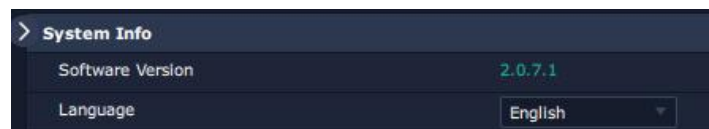

Keyboard Management: click <Keyboard> to enter the interface shown in the right.

Keyboard Setting is designed to fit for different operation system such as Windows and Mac.

Users can **set short cut keys**.



Drag Input, Output, Layer and Preset from the list to the keys you desired as shown in the figure:

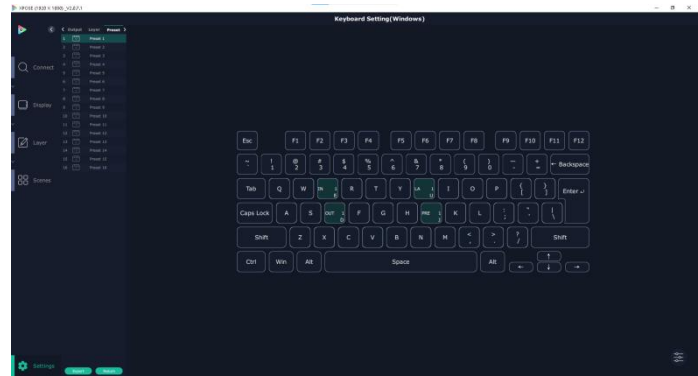

Please note the keyboard area where allows to set short cut keys



If the setting goes wrong or no need for short cut keys

any more, click  to **clear** some keys or clear all.

Clear: is to clear some keys, the keys need to selected before hand.

Clear all: is to remove all already set short cut keys.

Users can also **Save The Keyboard Setting As Script**.

Script Set

File Path: Save the current Keyboard Settings in the script to the local path

File Name: script file name

Load Script: Load/Delete



Click Return to back to <System Setting>

Communication Setting: The default is <search>, if it is <direct>, users need to type the corresponding IP address.

Serial Port: search only those connect via serial port.

Ethernet Connection: search only those connect via Ethernet.

Both Are Chosen : click both, both connections change synchronously.

Display Setting: Users can turn on **Expanding Mode** if there is an extension screen.

Novice Guide : check novice guide for quicker operation of XPOSE software.

Auto Connect : turn on auto connection switch and the interface will pop up a prompt to remind the user whether to restore the previous interface.

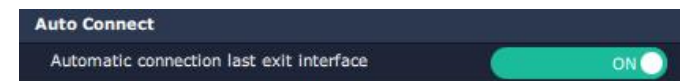
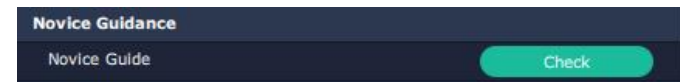
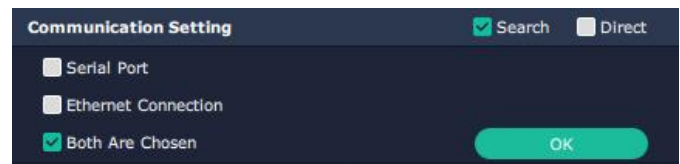
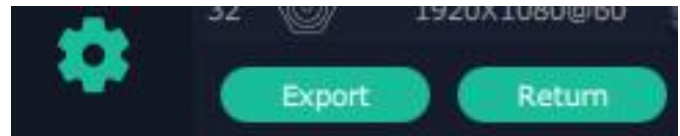

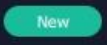

Authorization Setting

Click  to open up the authorization entry.

 **New:** Add new USER NAME and PASSWORD

 **Edit:** Edit user name and password already built.

 **Delete:** Delete user name and password already built.

 **Permission:** functions on this XPOSE 2.0 on this computer that the users are allowed to operate. Click the green block to remove the function not to be permitted.

Click “new”, type in User Name and Password.

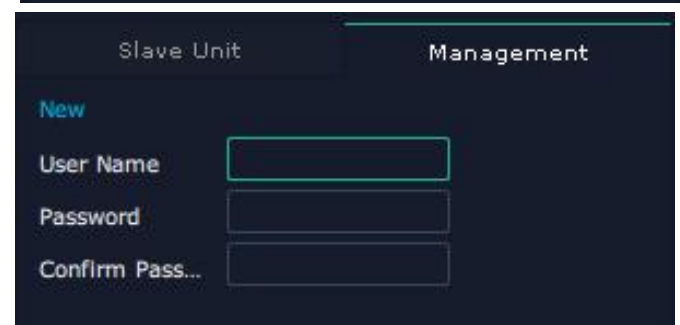
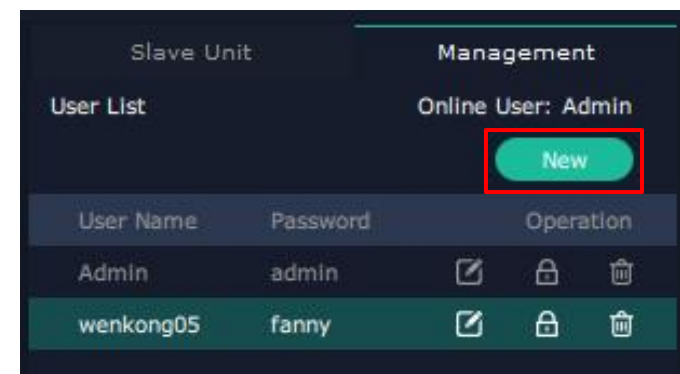

 Authorization Set: click on the function that

allows other users to take action

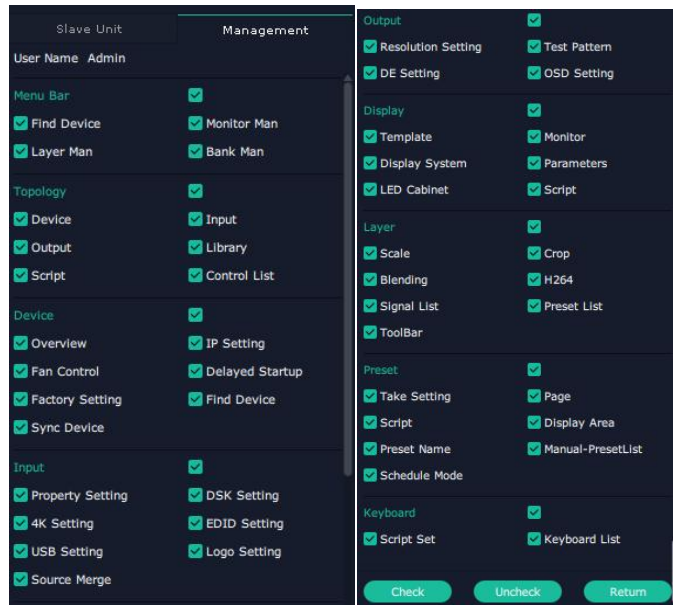



Slave Unit:

Slave Unit is to control multiple devices **simultaneously**, which are connected to same network. (“**In the same network**” means that the the third section in the IP address digits are the same)

XPOSE do operation on one device, same operation synchronized to other devices. For example, there is another devices linked to the same network, one with IP: 192.168.0.112, SN:0027; the other with IP: 192.168.0.129, SN: 3344.

If you want the same operation on 3344 to be backed up to 0027, you can do as follows.



1. Set device numbers;
2. Select the IP of the device in the drop-down menu for Device IP;
3. click **ON**,the tow device are connected when the red pot  turns to be green one ;
4. click **OFF to disconnect**, it could not control two device at the same time.

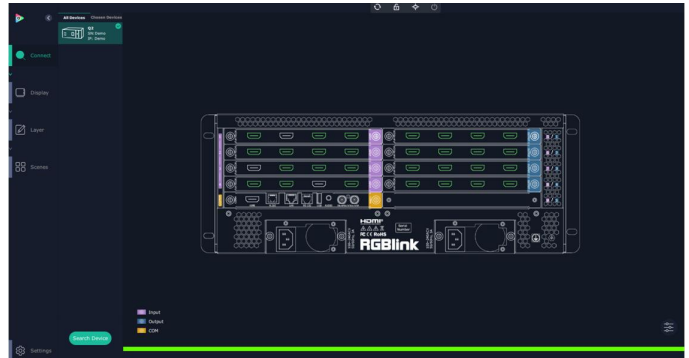

3.3.3 Output|Input|Overview

Click  to check rear panel interface as shown in the right figure.



Note:  purple tip indicates input,  blue tip indicates output,  yellow tip indicates communication.

Device Connection

1. Click the device you need in the <All Devices> list.



2. click  in the <Chosen Device>.



Output Setting

Click any output port, the board where the port locates is selected. Users can do settings to the port now.

A red rectangle flashes around the chosen port when it is clicked.

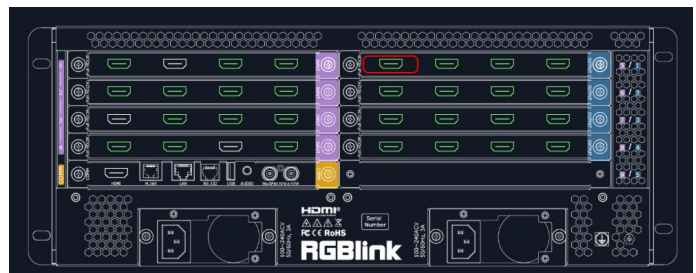

SDI and HDMI output modules support resolution settings.

Output resolution supports **ALL and MODULE Format Range** optional.

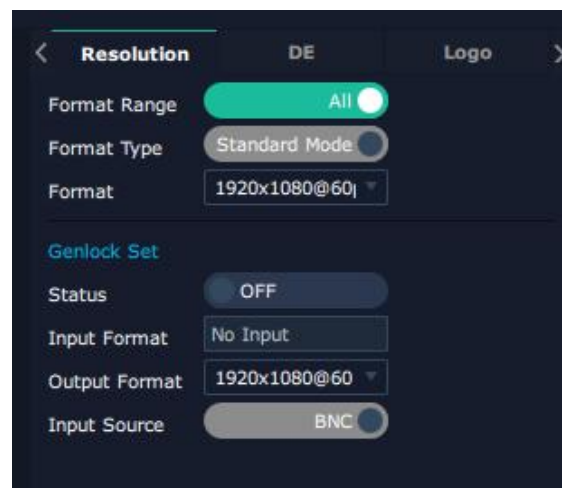

All Format Range: is to set output resolution of all output modules to be the same. Resolutions can be chosen as shown in the right figure.

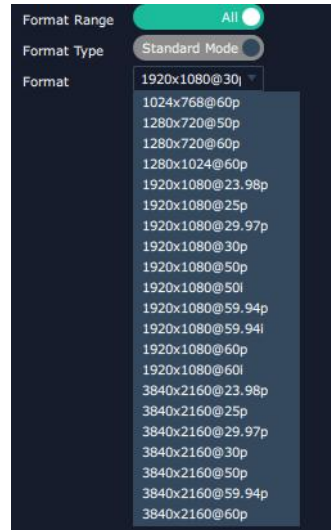

All Format Range

Module Format Range: is to set the resolution of all output ports of the selected module to be the same. The resolution of other modules can be set to different resolutions. Resolutions can be chosen as shown in the right figure.

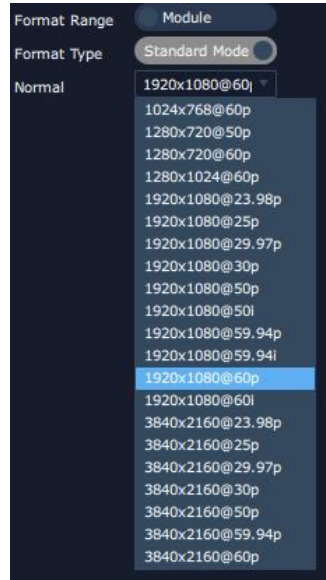

Module Format Range

DE:

Port: Current Port/All Port

Type: DVI/HDMI

Bits: Fixed value 8 bits

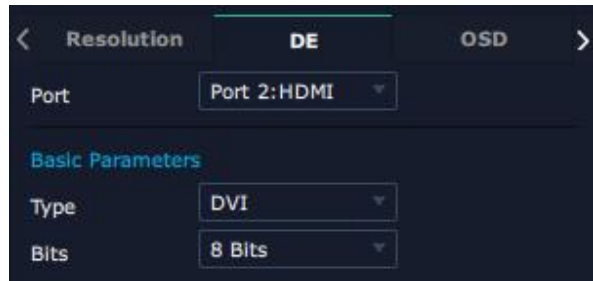

OSD:

Q16pro output modules which support OSD are shown below: **(Please Turn ON Status before setting)**

- Quad HDMI 1.3 Output Module
- Quad 3G SDI Output Module (to be published)
- Quad DVI Output Module (to be published)
- Dual HDMI 2.0 Output Module (to be published)
- IP Output Module (to be published)

Order Codes please refer to 4.2 Chapter.

Output Port : current output port

Status : ON/OFF OSD

X/Y: the starting horizontal and vertical position

Width/Height : the horizontal and vertical size of the text

Font: font of the text, all fonts installed in the computer are available

Font Type : Normal,Italic,Bold,Bold Italic

Font Size : 0-300 pixels

Alignment: set alignment type

Background: choose transparent background or set background color

Scroll Speed: 0-16

Scroll Direction: Scroll Off, Scroll Left

Input Text: The exact content of the text

After setting, users choose **Save OSD, Clear OSD**

(If the setting is not desired) or **Close All OSD**.

After all settings done, click **<Set>** and the OSD will be displayed on the screen.

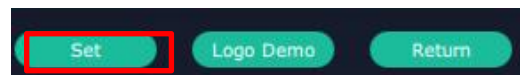
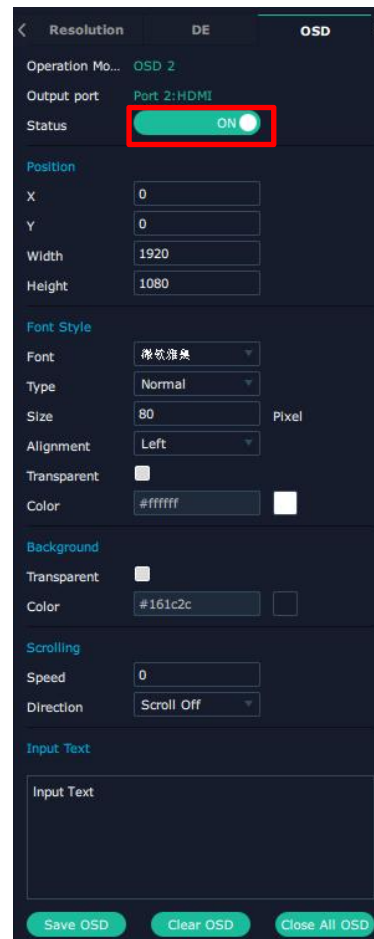

LOGO: Users need to pre-store the Logo on the SD card for Logo capture.

Output Port: current port

Logo Operation:

Logo Capture:

Logo ID: Load Logo ID been saved

Set Logo:

Status: Hide/Show Logo

X/Y: Horizontal and vertical position of Logo

Delete Logo: Clear logo set already



Input Setting

Click any input port, the board where the port locates is selected. Users can do settings to the port now.

A red rectangle flashes around the chosen port when it is clicked.

User can set <Property> and <EDID>.

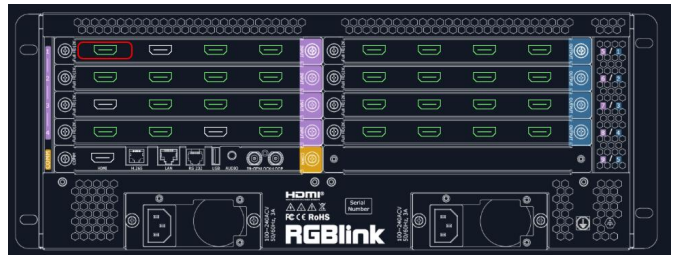

Property Setting

Input Port: chosen port

Scale:

X/Y: the starting horizontal and vertical position

Width/Height : the horizontal and vertical size of scale.

Crop:

Support cropping for position, height and width.

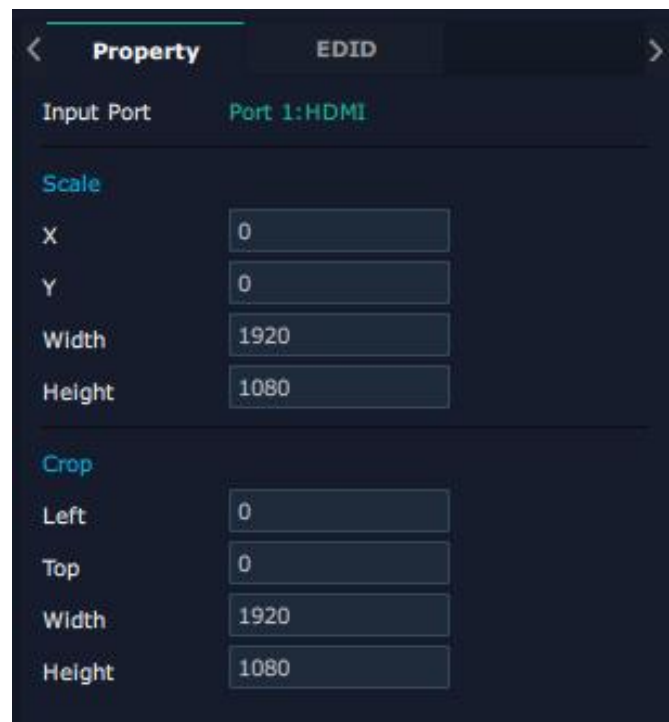

EDID

Input Port: chosen port

Basic Parameters:

EDID Template: RGB-DVI or RGB-HDMI

Monitor Name: type the monitor name

Width/Height/Frequency: type in custom parameters to meet your needs.

Q16pro's modules which support EDID are as follows:

- Quad HDMI 1.3 Input Module
- HDMI 2.0 & DP 1.2 4K@60 Input Module (to be published)
- Quad DVI Input Module (to be published)

Order Codes of modules please refer to 4.2.

Communication Board with PVW

When there is communication Board with PVW input module installed on Q16pro, you can click HDMI port for following operations.

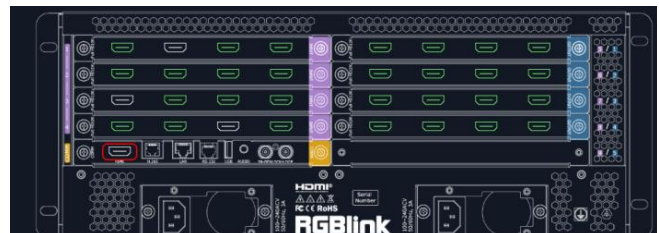
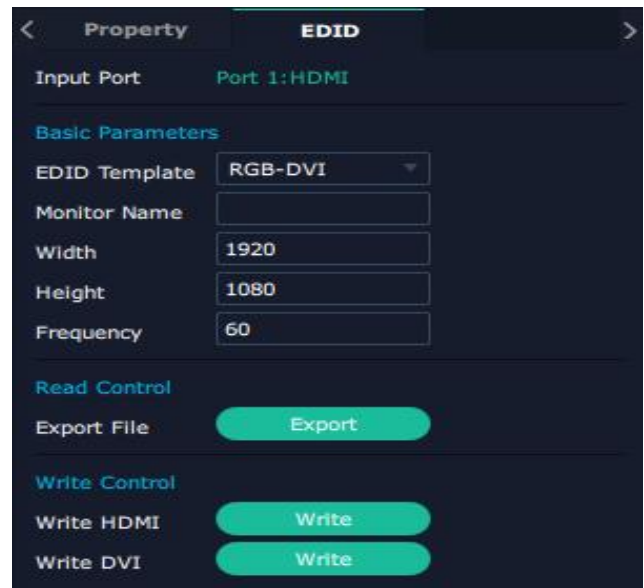

OSD:

Output Port: current HDMI port

Font Style:

Status: Please turn on Status before setting

Font: font of the text, all fonts installed in the computer are available

Font Type : Normal,Italic,Bold,Bold Italic

Font Size : 0-300 pixels (40 by default)

Alignment: set alignment type

Color: set font color

Frame

Status: turn on status to set frame color

Color: set frame color

Input Text: The exact content of the text

Window Index: Select window to display OSD

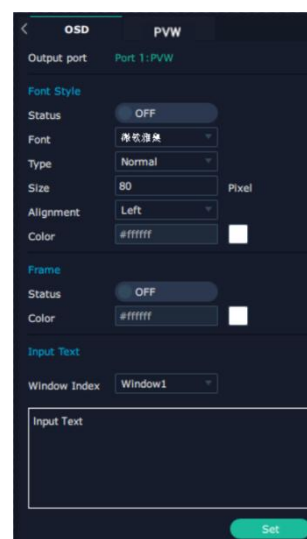

PVW:

Display Mode: Preview Input **ONLY**

Equal: 16 Equal/9 Equal/ 4 Equal/ 2+8/ 2+4 layout available

Input Monitor: Select input signal for each window

As shown in the right, Window 1 displays input signal 5, Window 2 displays input signal 3, Window 3 displays input signal 1.



Overview

Click Return Return, there are Overview, IP, Fan Control, Factory Setting.

Device Info: users can check current temperature and MAC information

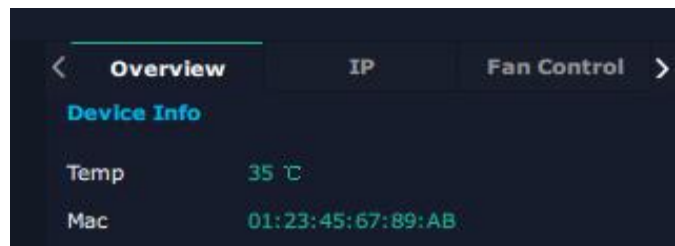

Input Module Info: users can check current input module name and MCU version

“...” indicates that there are no input modules, as shown in the right figure.

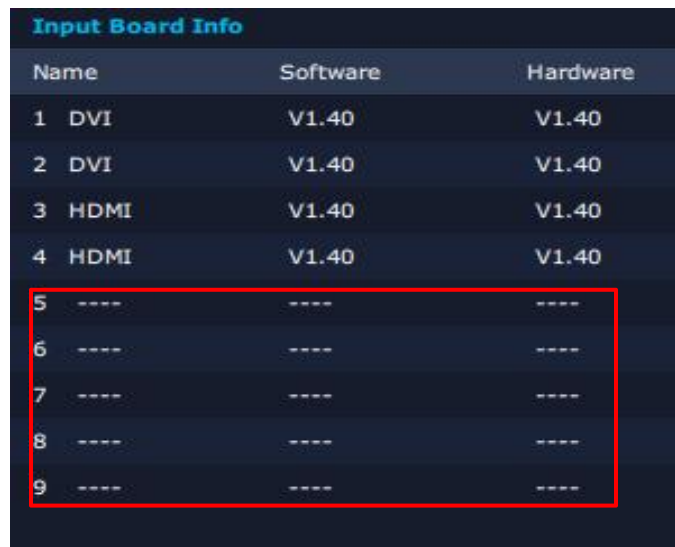

Output Module Info : users can check current output module name and MCU version

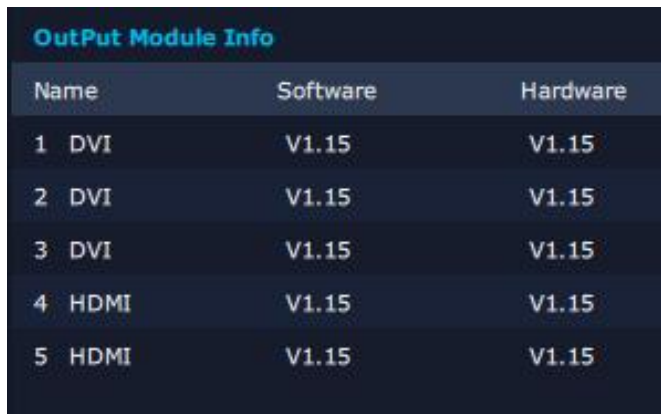

Name	Software	Hardware
1 DVI	V1.15	V1.15
2 DVI	V1.15	V1.15
3 DVI	V1.15	V1.15
4 HDMI	V1.15	V1.15
5 HDMI	V1.15	V1.15

IP: Support auto/manual setting. Show IP Address, Netmask, Gateway



Overview IP Fan Control

Auto IP Address

IP Address: 192 - 168 - 000 - 100

Netmask: 255 - 255 - 255 - 000

Gateway: 192 - 168 - 000 - 001

Fan Control: Support auto/manual setting.
Fan Speed: 0-100

Notice: To avoid insufficient heat dissipation, the recommended manual fan speed is not less than 30.

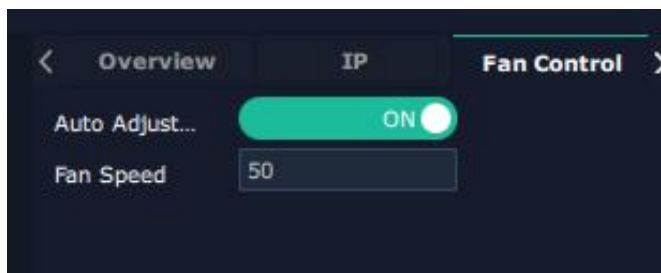

Overview IP Fan Control

Auto Adjust... ON

Fan Speed: 50

Factory Setting

Remove EDID: Clear the previous EDID parameter
Save IP: No change of IP after reset



Overview IP Fan Control Factory Setting

Please select a need reset function

Remove EDID

Save IP

3.3.4 Display Management

Display System is for users to set layout of outputs.



Click this icon first and then click  enter the interface.

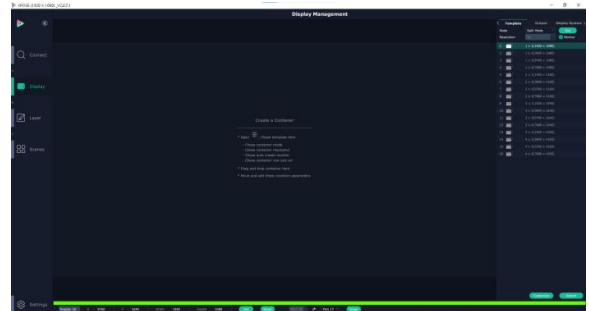

Container:

Container here means the Display Area, for example it could be a formed LED screen or an array of LCDs.

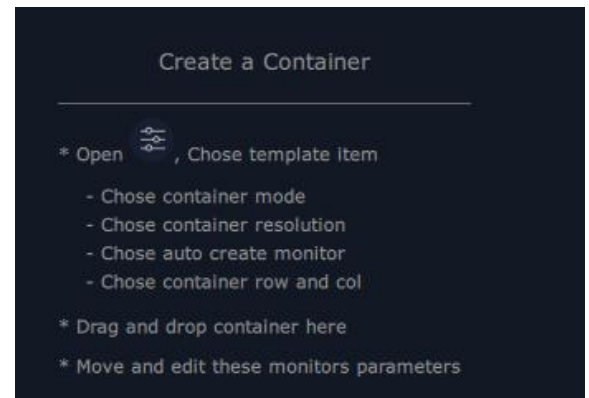

Template

There are 16 types of basic “Display Area” which is used to contain output interface, and could be regarded as layout of output.

Drag a template to create a container in other word a display area.

Resolution

Users can choose output resolution as shown in the figure.

Mode

Each mode is marked in different color and provided with fitted templates. Users can do operations like splice under different modes.

Q16pro: Split Mode and Matric Mode (by default) optional.

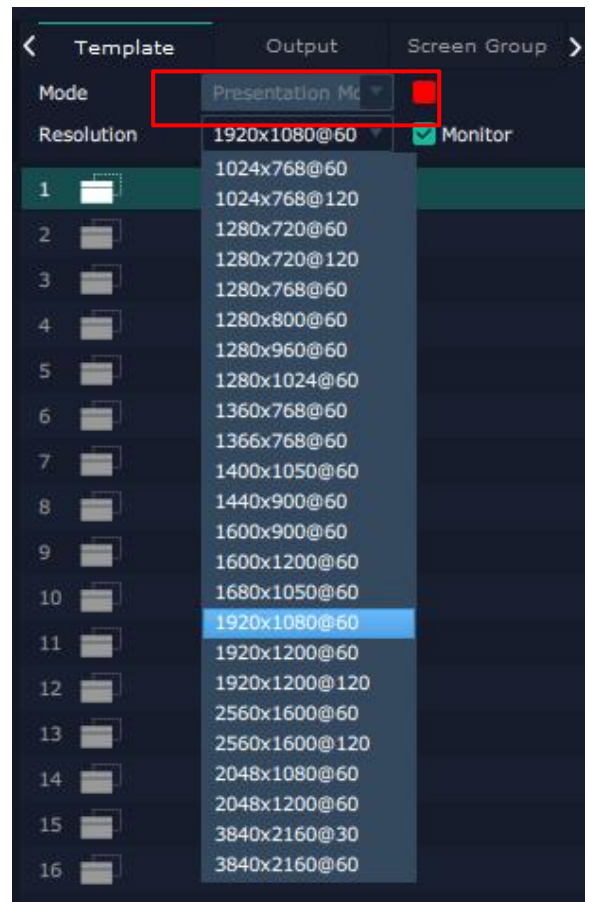

Split Mode: No container is reserved after change of resolution. Need of recreating a container.

Create a Container

- * Open , Chose template item
 - Chose container mode
 - Chose container resolution
 - Chose auto create monitor
 - Chose container row and col
- * Drag and drop container here
- * Move and edit these monitors parameters

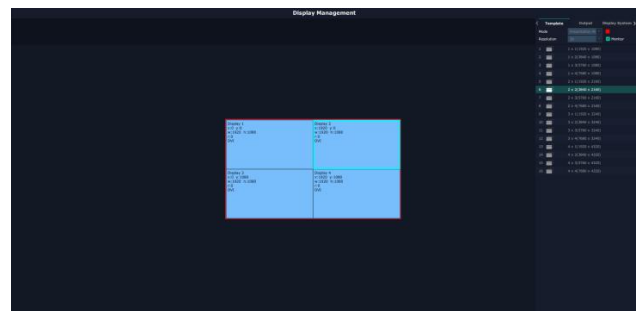

Matrix Mode: No need of recreating a container after changing resolution.



Customize Container

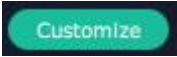

Click this icon at the bottom of template list.

Monitor Layout: Auto or Manual

Steps of create container are as follows:

1. Fill in H Total/V Total and Row/Column, it will calculate H item and V item automatically. For example, if you would like to create a container with 2 rows and 3 columns and each display has a width of 1920 and a height of 1080, the total width will be 5760 and the total height will be 2160.
2. Click <Create>, the container will display in the interface, and shows the width and height of each Display.
3. Click <Save> to save the container.

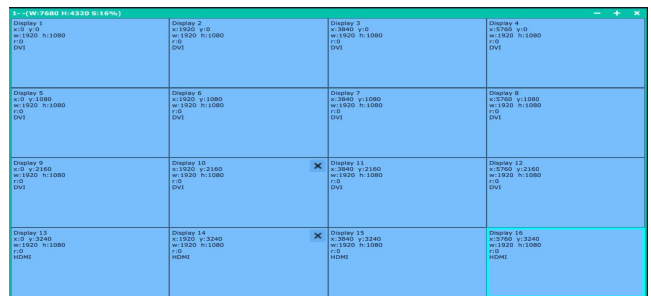

Container Adjustment

1. **Move:** Drag the boarder of the display area to move its place in the interface.
2. **Scale:** Click icon to shrink, Click to enlarge the proportion of display area on interface.
3. **Cancel:** Long pressing the to cancel the screen group.

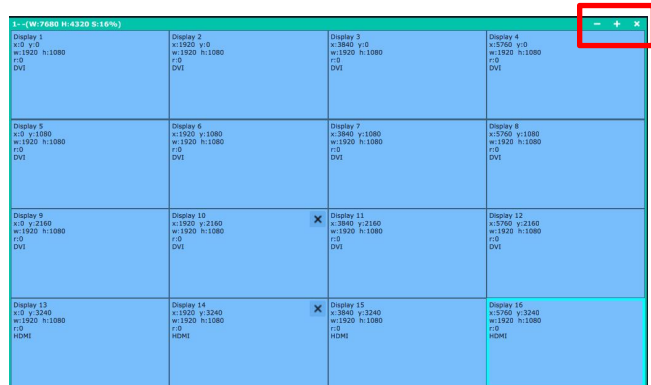

Display

Output List:

White one: available

Gray one: unavailable

Operation Steps:

Left-mouse click the output and drag it to the display of the set container.

Replacement:

Drag and drop the output into the corresponding display. The output being replaced will turn from gray to white in the list.



Display System

Q16pro allows users to edit the name of the Display Area that has been created just click the

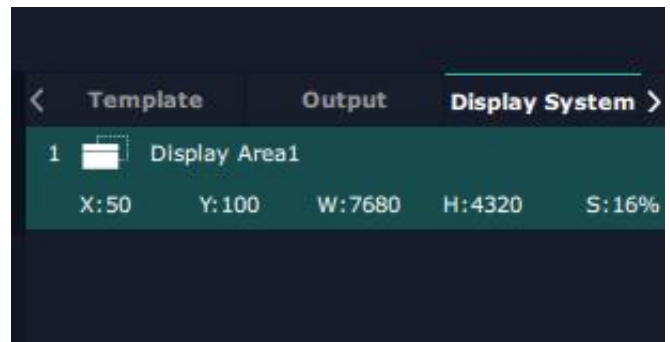

3.3.5 Layer Management

Layer Management is designed to manage the layer of each monitor. Click this icon  to enter the interface:

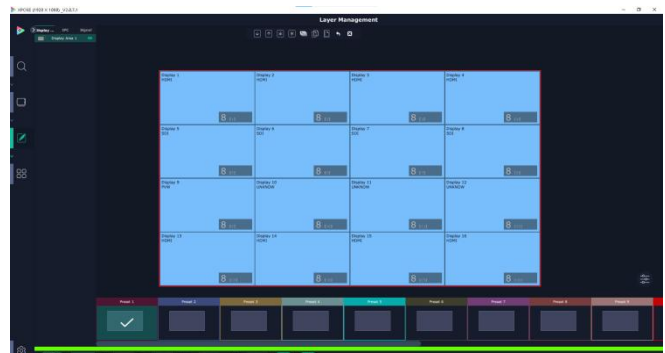

Display Area

When enter Layer Management interface, the window is blank. The screen group created in Display System shall be dragged from the **Display Area**.



IPC

IPC is short for IP Camera, that is, the signal of IP camera accessed through IP input module are displayed here.

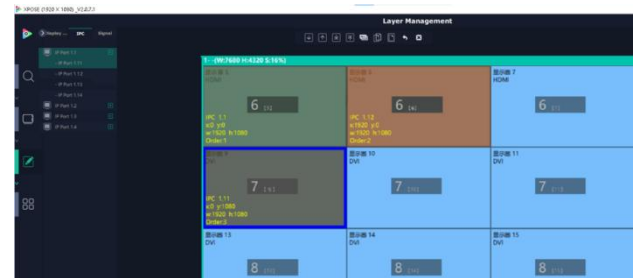

Signal

Signal list, showing all input signals and resolutions currently. Drag the signal to the display.

click , users can rename the input signal and then

click  to confirm.



Layer

Layer number: Numbers in the corner is to show how many layers at present allowed to put in the output.

The number in the red rectangle on the right figure represents the number of layers that can be placed at the output.

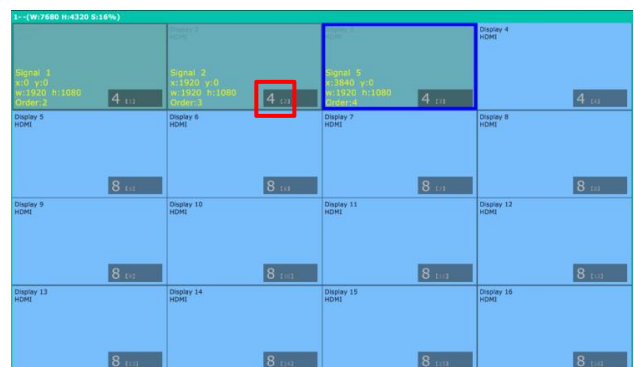

Layer Adjustment:

there are two ways to adjust layer.

1. Use the bar under the interface

Choose one layer and the bar shows its signal source, type in position and size. click **Set** to confirm.

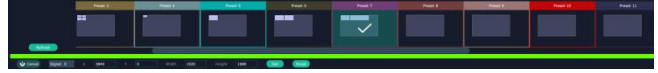

2. Layer Scale and Crop

Choose one layer needed to be adjusted, and type in its position and size.



this icon means data related, when width is changed, height will be changed as same proportion.



this icon means data not related, width and height need to be filled respectively.

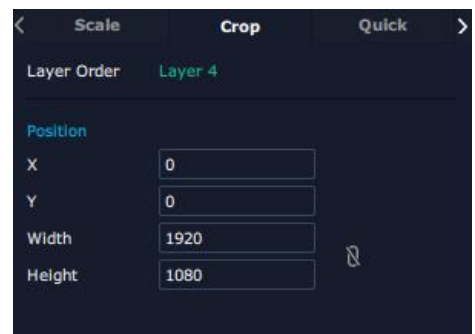
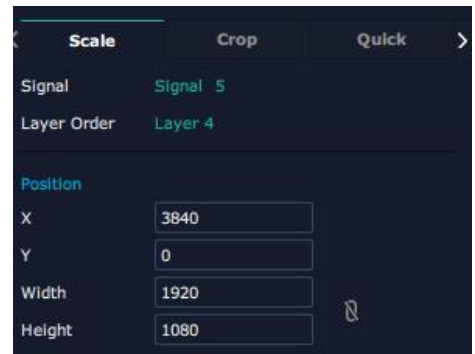

Quick

Quick is to set layer layout quickly.

- Single Monitor:** choose the **output port** you would like to set
- Single Board:** choose the **output board** you would like to set
- All Monitors:** set close or on
- Layer Set:** set layer layout

Users can drag and drop the source from the Signal List.

After setting, click **<Set>** to confirm and the layout will be shown on the interface as shown in the right figure.

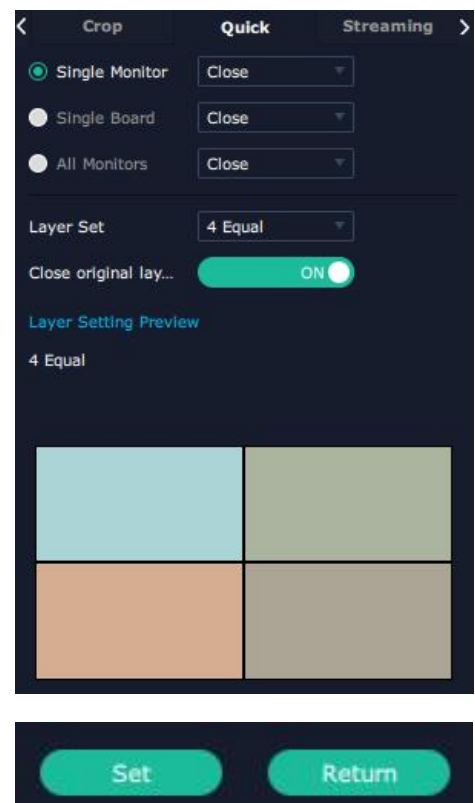

Stream

H.265 Module supports to preview image.

Image Quality: smooth (by default), normal, HI-Q

Users can do refer to steps below:

1. Turn on Layer Preview, Input Preview, Scene Preview or Expand Preview according to the actual need.

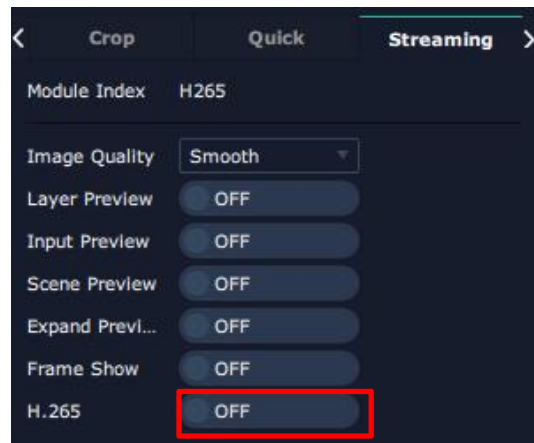

2. Turn on H.265 and users can preview the image. As shown in the right figure, the interface shows that Layer Preview, Input Preview, Scene Preview are turned on.

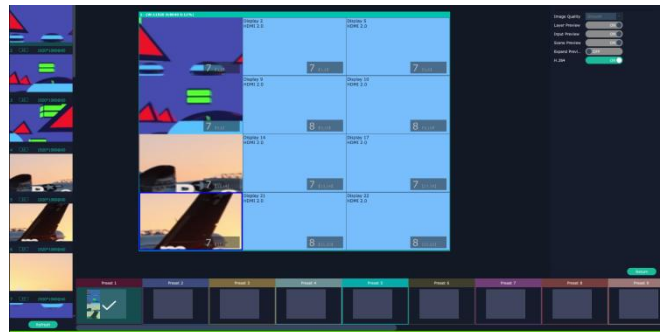

Note: H.265 is the master switch. If the user turns on H.264 first, it cannot be set successfully.

Layer Movement

Moving the mouse to drag the layer.

Layer Remove

Click the cross on the top right of the layer to remove the layer if needed.



Layer Set



:to crop the layer



:lock the layer to prevent wrong operations



:max to cover up the monitor.



: cover up all monitors in the same screen group

with the one signal.



Layer Copy

Press Ctrl and mouse left at the same time, move the mouse the layer selected can be copied and place in any monitor in the same Display Area but it doesn't work when cross over display area.

Other Operation on Layer



Use the tools bar on top of window to do such operations

	Layer Backward		Layer to Top		Paste Selected
	Layer Forward		Select All		Cancel Selected
	Layer to Bottom		Copy Selected		Delete Selected

3.3.6 Preset Management

Preset Management is designed to switch bank (scene setting done in last step).

Preset Management Mode:

1. Manual Mode
2. Schedule Mode

1. Manual Mode

The chosen scene will be displayed in the main interface, and the PGM screen is in the first in the Bank Column.

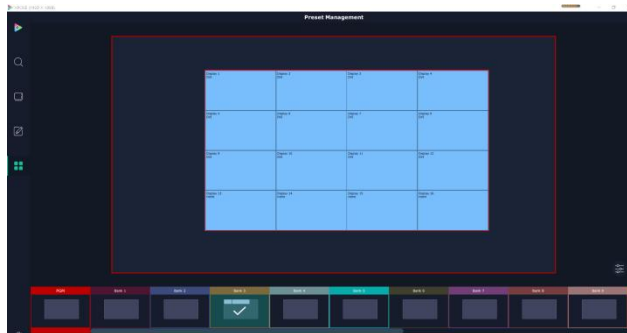

Cut

Cut, switch from PVW to PGM immediately .

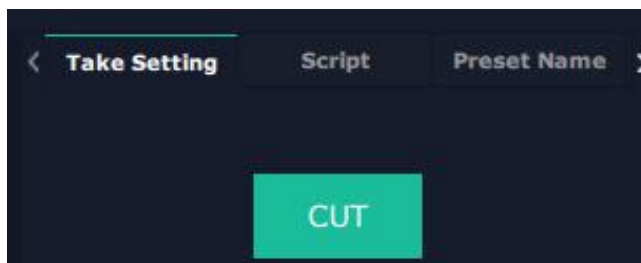

Script

Click <Script>, fill in the file name and click “Save”, the file can be seen in the <Load Script>

Click “Load”  to load the file into XPOSE.

Click “Delete”  to delete saved script.

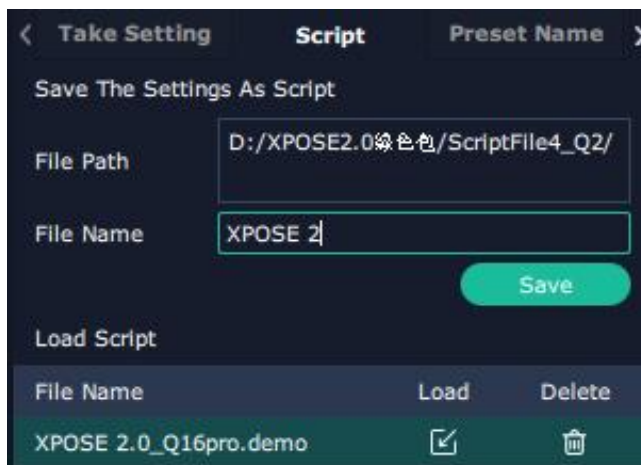

Preset Name

Select a bank and click Preset Name, fill in the blank after New Preset Name to rename a Preset (Bank)
Click the color block after Color Selection and choose a new color for the boarder of chosen bank.

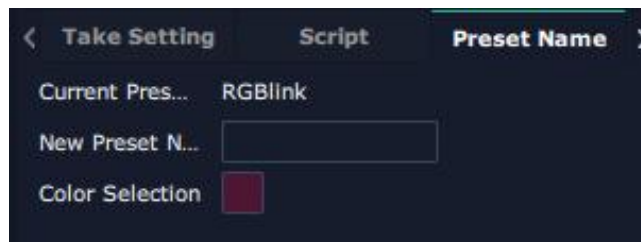

Hotkey

Use hotkey to let the operation in Preset Management more convenient.

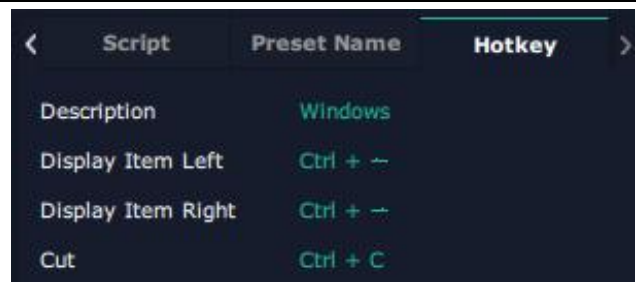

Script	Preset Name	Hotkey
Description	Windows	
Display Item Left		Ctrl + ←
Display Item Right		Ctrl + →
Cut		Ctrl + C



2. Schedule Mode

This mode is designed to set auto bank (scene/preset) switch.

Steps are as follows:

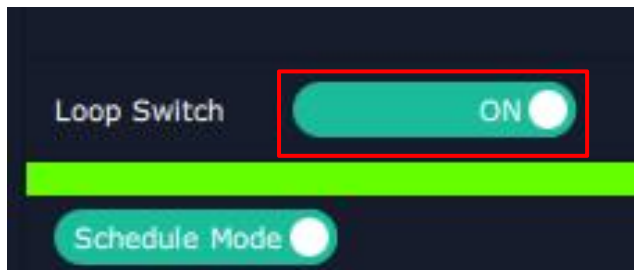
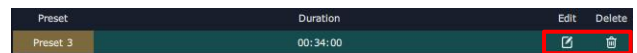
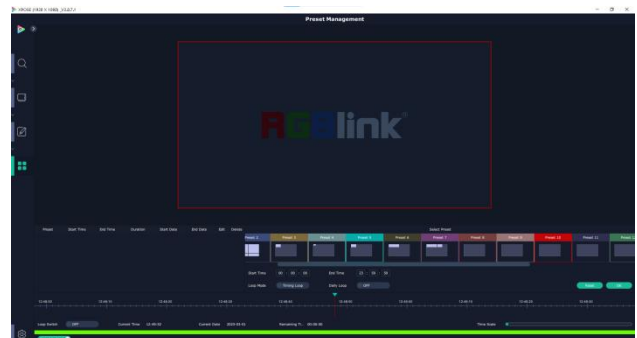
1. Turn on “**Schedule Mode**”
2. Choose “**Times Loop**” in Loop Mode
3. Choose the **BANK**
4. Fill in the “**Duration**”
5. Click “**OK**”



Users can click  to edit and  to delete. After

settings done, turn on “**Loop Switch**” .

Chapter 4 Order Code

4.1 Product Code

710-1002-06-0	Q16pro Gen2 2U (preliminary)
710-1002-01-1	Q16pro Gen2 4U (Communication Module Included)
710-1002-01-0	Q16pro Gen2 4U (Communication Module with PVW Included)
710-1002-07-0	Q16pro Gen2 8U (preliminary)
710-1002-08-0	Q16pro Gen2 14U (preliminary)

4.2 Module Code

4.2.1 Input Modules

790-1002-01-0	Q Series Quad HDMI 1.3 Input Module
790-1002-02-0	Q Series Single IP Input Module (preliminary)
790-1002-03-0	Q Series Quad HDMI 2.0 & DP 1.2 Input Module (preliminary)
790-1002-04-0	Q Series Quad 3G SDI (LOOP) Input Module (preliminary)
790-1002-05-0	Q Series Quad DVI Input Module (preliminary)

4.2.2 Output Modules

790-1002-21-0	Q Series Quad HDMI 1.3 Output Module
790-1002-23-0	Q Series Dual HDMI 2.0 Output Module (preliminary)
790-1002-25-0	Q Series Quad 3G SDI Output Module (preliminary)
790-1002-26-0	Q Series Quad DVI Output Module (preliminary)
790-1002-27-0	Q Series Single IP Output Module (preliminary)

4.2.3 Others

790-1002-22-0	Q Series Communication Module with PVW
790-1002-24-0	Q Series Communication Module
950-1004-01-0	Q Series 300W Redundant Power Module

Chapter 5 Support

5.1 Contact Us

www.rgblink.com



Inquiries

+86-592-577-1197
info@rgblink.com
rgblink.com/contact-us

Global Support

support@rgblink.com
rgblink.com/support-me



@RGLINK



/rgblink



+rgblink



/rgblink



rgblink



rgblink

RGBlink Headquarters

Xiamen, China

Room 601A, No. 37-3
Banshang community,
Building 3, Xinke Plaza, Torch
Hi-Tech Industrial
Development Zone, Xiamen,
China

+86-592-577-1197

China Regional Sales & Support

Shenzhen, China

705, 7th Floor, South District,
Building 2B, Skyworth
Innovation Valley, No. 1
Tangtuo Road, Shiyan Street,
Baoan District, Shenzhen City,
Guangdong Province

+86-755 2153 5149

Beijing Region Office

Beijing, China

Building 8, 25 Qixiao Road
Shahe Town Changping

+010- 8577 7286

Europe Regional Sales & Support

Eindhoven, Holland

Flight Forum Eindhoven
5657 DW

+31 (040) 202 71 83

Chapter 6 Appendix

6.1 Terms & Definitions

- **RCA:** Connector used primarily in consumer AV equipment for both audio and video. The RCA connector was developed by the Radio Corporation of America.
- **BNC:** Stands for Bayonet Neill-Concelman. A cable connector used extensively in television (named for its inventors). A cylindrical bayonet connector that operates with a twist-locking motion .
- **CVBS:** CVBS or Composite video, is an analog video signal without audio. Most commonly CVBS is used for transmission of standard definition signals. In consumer applications the connector is typically RCA type, while in professional applications the connector is BNC type.
- **YPbPr:** Used to describe the colour space for progressive-scan. Otherwise known as component video.
- **VGA:** Video Graphics Array. VGA is an analog signal typically used on earlier computers. The signal is non-interlaced in modes 1, 2, and 3 and interlaced when using in mode.
- **DVI:** Digital Visual Interface. The digital video connectivity standard that was developed by DDWG (Digital Display Work Group). This connection standard offers two different connectors: one with 24 pins that handles digital video signals only, and one with 29 pins that handles both digital and analog video.
- **SDI:** Serial Digital Interface. Standard definition video is carried on this 270 Mbps data transfer rate. Video pixels are characterized with a 10-bit depth and 4:2:2 color quantization. Ancillary data is included on this interface and typically includes audio or other metadata. Up to sixteen audio channels can be transmitted. Audio is organised into blocks of 4 stereo pairs. Connector is BNC.
- **HD-SDI:** High-definition serial digital interface (HD-SDI), is standardized in SMPTE 292M this provides a nominal data rate of 1.485 Gbit/s.
- **3G-SDI:** Standardized in SMPTE 424M, consists of a single 2.970 Gbit/s serial link that allows replacing dual link HD-SDI.
- **6G-SDI:** Standardized in SMPTE ST-2081 released in 2015, 6Gbit/s bitrate and able to support 2160p@30.
- **12G-SDI:** Standardized in SMPTE ST-2082 released in 2015, 12Gbit/s bitrate and able to support 2160p@60.
- **U-SDI:** Technology for transmitting large-volume 8K signals over a single cable. a signal interface called the ultra high definition signal/data interface (U-SDI) for transmitting 4K and 8K signals using a single optical cable. The interface was standardized as the SMPTE ST 2036-4.
- **HDMI:** High Definition Multimedia Interface: An interface used for the transmission of uncompressed high definition video, up to 8 channels of audio, and control signals, over a single cable.
- **HDMI 1.3:** Released on June 22 2006, and increased the maximum TMDS clock to 340 MHz (10.2 Gbit/s).

Support resolution 1920 × 1080 at 120 Hz or 2560 × 1440 at 60 Hz). It added support for 10 bpc, 12 bpc, and 16 bpc color depth (30, 36, and 48 bit/px), called deep color.

●**HDMI 1.4:** Released on June 5, 2009, added support for 4096 × 2160 at 24 Hz, 3840 × 2160 at 24, 25, and 30 Hz, and 1920 × 1080 at 120 Hz. Compared to HDMI 1.3, 3 more features added which are HDMI Ethernet Channel (HEC), audio return channel (ARC), 3D Over HDMI, a new Micro HDMI Connector, an expanded set of color spaces.

●**HDMI 2.0:** Released on September 4, 2013 increases the maximum bandwidth to 18.0 Gbit/s. Other features of HDMI 2.0 include up to 32 audio channels, up to 1536 kHz audio sample frequency, the HE-AAC and DRA audio standards, improved 3D capability, and additional CEC functions.

●**HDMI 2.0a:** Was released on April 8, 2015, and added support for High Dynamic Range (HDR) video with static metadata.

●**HDMI 2.0b:** Was released March, 2016, support for HDR Video transport and extends the static metadata signaling to include Hybrid Log-Gamma (HLG).

●**HDMI 2.1:** Released on November 28, 2017. It adds support for higher resolutions and higher refresh rates, Dynamic HDR including 4K 120 Hz and 8K 120 Hz.

●**DisplayPort:** A VESA standard interface primarily for video, but also for audio, USB and other data. DisplayPort (orDP) is backwards compatible with HDMI, DVI and VGA.

●**DP 1.1:** Was ratified on 2 April 2007, and version 1.1a was ratified on 11 January 2008. DisplayPort 1.1 allow a maximum bandwidth of 10.8 Gbit/s (8.64 Gbit/s data rate) over a standard 4-lane main link, enough to support 1920x1080@60Hz

●**DP 1.2:** Introduced on 7 January 2010, effective bandwidth to 17.28 Gbit/s support increased resolutions, higher refresh rates, and greater color depth, maximum resolution 3840 × 2160@60Hz

●**DP 1.4:** Publish on 1 Mar, 2016. overall transmission bandwidth 32.4 Gbit/s, DisplayPort 1.4 adds support for Display Stream Compression 1.2 (DSC), DSC is a "visually lossless" encoding technique with up to a 3:1 compression ratio. Using DSC with HBR3 transmission rates, DisplayPort 1.4 can support 8K UHD (7680 × 4320) at 60 Hz or 4K UHD (3840 × 2160) at 120 Hz with 30 bit/px RGB color and HDR. 4K at 60 Hz 30 bit/px RGB/HDR can be achieved without the need for DSC.

●**Multi-mode Fiber:** Fibers that support many propagation paths or transverse modes are called multi-mode fibers, generally have a wider core diameter and are used for short-distance communication links and for applications where high power must be transmitted.

●**Single-mode Fiber:** Fiber that support a single mode are called single-mode fibers. Single-mode fibers are used for most communication links longer than 1,000 meters (3,300 ft).

●**SFP:** Small form-factor pluggable, is a compact, hot-pluggable network interface module used for both telecommunication and data communications applications.

●**Optical Fiber Connector:** Terminates the end of an optical fiber, and enables quicker connection and disconnection than splicing. The connectors mechanically couple and align the cores of fibers so light can pass. 4 most common types of optical fiber connectors are SC, FC, LC,ST.

●**SC:** (Subscriber Connector), also known as the square connector was also created by the Japanese company – Nippon Telegraph and Telephone. SC is a push-pull coupling type of connector and has a 2.5mm diameter. Nowadays, it is used mostly in single mode fiber optic patch cords, analog, GBIC, and CATV. SC is one of the most popular options, as its simplicity in design comes along with great durability and affordable prices.

●**LC:** (Lucent Connector) is a small factor connector (uses only a 1.25mm ferrule diameter) that has a snap coupling mechanism. Because of its small dimensions, it is the perfect fit for high-density connections, XFP, SFP, and SFP+ transceivers.

●**FC:** (Ferrule Connector) is a screw type connector with a 2.5mm ferrule. FC is a round shaped threaded fiber optic connector,mostly used on Datacom, telecom, measurement equipment, single-mode laser.

●**ST:** (Straight Tip) was invented by AT&T and uses a bayonet mount along with a long spring-loaded ferrule to support the fiber.









●**USB:** Universal Serial Bus is a standard that was developed in the mid-1990s that defines cables, connectors and communication protocols. This technology is designed to allow a connection, communication and power supply for peripheral devices and computers.

●**USB 1.1:** Full-Bandwidth USB, specification was the first release to be widely adopted by the consumer market. This specification allowed for a maximum bandwidth of 12Mbps.

●**USB 2.0:** or Hi-Speed USB, specification made many improvements over USB 1.1. The main improvement was an increase in bandwidth to a maximum of 480Mbps.

● **USB 3.2:** Super Speed USB with 3 varieties of 3.2 Gen 1(original name USB 3.0), 3.2Gen 2(original name USB 3.1), 3.2 Gen 2x2 (original name USB 3.2) with speed up to 5Gbps,10Gbps,20Gbps respectively.

USB version and connectors figure:

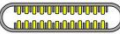
	Type A	Type B	Mini A	Mini B	Micro-A	Micro-B	Type C
USB 2.0							
USB 3.0							
USB 3.1&3.2							

●**NTSC:** The colour video standard used in North America and some other parts of the world created by the National Television Standards Committee in the 1950s. NTSC utilizes an interlaced video signals.

●**PAL:** Phase Alternate Line. A television standard in which the phase of the colour carrier is alternated from line to line. It takes four full images (8 fields) for the colour-to-horizontal images (8 fields) for the colour-to-horizontal phase relationship to return to the reference point. This alternation helps cancel out phase errors. For this reason, the hue control is not needed on a PAL TV set. PAL, is widely used in needed on a PAL TV set. PAL, is widely used in Western Europe, Australia, Africa, the Middle East, and Micronesia. PAL uses 625-line, 50-field (25 fps) composite colour transmission system.

●**SMPTE:** Society of Motion image and Television Engineers. A global organization, based in the United States, that sets standards for baseband visual communications. This includes film as well as video and television standards.

●**VESA:** Video Electronics Standards Association. An organization facilitating computer graphics through standards.

●**HDCP:** High-bandwidth Digital Content Protection (HDCP) was developed by Intel Corporation and is in wide use for protection of video during transmission between devices.

●**HDBaseT:** A video standard for the transmission of uncompressed video (HDMI signals) and related features using Cat 5e/Cat6 cabling infrastructure.

●**ST2110:** A SMPTE developed standard, ST2110 describes how to send digital video over and IP networks. Video is transmitted uncompressed with audio and other data in a separate streams.

SMPTE2110 is intended principally for broadcast production and distribution facilities where quality and flexibility are more important.

●**SDVoE:** Software Defined Video over Ethernet (SDVoE) is a method for transmission, distribution and management AV signals using a TCP/IP Ethernet infrastructure for transport with low latency. SDVoE is commonly used in integration applications.

●**Dante AV:** The Dante protocol was developed for and widely adopted in audio systems for the transmission of uncompressed digital audio on IP based networks. The more recent Dante AV specification includes support for digital video.

●**NDI:** Network Device interface (NDI) is a software standard developed by NewTek to enable video-compatible products to communicate, deliver, and receive broadcast quality video in a high quality, low latency manner that is frame-accurate and suitable for switching in a live production environment over TCP (UDP) Ethernet based networks. NDI is commonly found in broadcast applications.

●**RTMP:** Real-Time Messaging Protocol (RTMP) was initially a proprietary protocol developed by Macromedia

(now Adobe) for streaming audio, video and data over the Internet, between a Flash player and a server.

●**RTSP:** The Real Time Streaming Protocol (RTSP) is a network control protocol designed for use in entertainment and communications systems to control streaming media servers. The protocol is used for establishing and controlling media sessions between end points.

●**MPEG:** Moving Picture Experts Group is a working group formed from ISO and IEC developing standards that allow audio/video digital compression and Transmission.

●**H.264:** Also known as AVC (Advanced Video Coding) or MPEG-4i is a common video compression standard. H.264 was standardized by the ITU-T Video Coding Experts Group (VCEG) together with the ISO/IEC JTC1 Moving Picture Experts Group (MPEG).

●**H.265:** Also known as **HEVC** (High Efficiency Video Coding)H.265 is the successor to the widely used H.264/AVC digital video coding standard. Developed under the auspices of ITU, resolutions up to 8192x4320 may be compressed.

●**API:** An Application Programming Interface (API) provides a predefined function which allows access capabilities and features or routines via a software or hardware, without accessing source code or understanding the details of inner working mechanism. An API call may execute a function and/or provide data feedback/report.

●**DMX512:** The communication standard developed by USITT for entertainment and digital lighting systems. The wide adoption of the Digital Multiplex (DMX) protocol has seen the protocol used for a wide range of other devices including video controllers. DMX512 is delivered over cable of 2 twisted pairs with 5pin XLR cables for connection.

●**ArtNet:** An ethernet protocol based on TCP/IP protocol stack, mainly used in entertainment/events applications. Built on the DMX512 data format, ArtNet enables multiple “universes” of DMX512 to be transmitted using ethernet networks for transport.

●**MIDI:** MIDI is the abbreviation of Musical Instrument Digital Interface. As the name indicates the protocol was developed for communication between electronic musical instruments and latterly computers. MIDI instructions are triggers or commands sent over twisted pair cables, typically using 5pin DIN connectors.

●**OSC:** The principle of Open Sound Control (OSC) protocol is for networking sound synthesizers, computers, and multimedia devices for musical performance or show control. As with XML and JSON, the OSC protocol allows sharing data. OSC is transported via UDP packets between devices connected on an Ethernet.

●**Brightness:** Usually refers to the amount or intensity of video light produced on a screen without regard to colour. Sometimes called black level.

●**Contrast Ratio:** The ratio of the high light output level divided by the low light output level. In theory, the

contrast ratio of the television system should be at least 100:1, if not 300:1. In reality, there are several limitations. Well-controlled viewing conditions should yield a practical contrast ratio of 30:1 to 50:1.

● **Colour Temperature:** The colour quality, expressed in degrees Kelvin (K), of a light source. The higher the colour temperature, the bluer the light. The lower the temperature, the redder the light. Benchmark colour temperature for the A/V industry include 5000°K, 6500°K, and 9000°K.

● **Saturation:** Chroma, Chroma gain. The intensity of the colour, or the extent to which a given colour in any image is free from white. The less white in a colour, the truer the colour or the greater its saturation. Saturation is the amount of pigment in a colour, and not the intensity.

● **Gamma:** The light output of a CRT is not linear with respect to the voltage input. The difference between what you should have and what is actually output is known as gamma.

● **Frame:** In interlaced video, a frame is one complete image. A video frame is made up of two fields, or two sets of interlaced lines. In a film, a frame is one still image of a series that makes up a motion image.

● **Genlock:** Allows synchronisation of otherwise video devices. A signal generator provides a signal pulses which connected devices can reference. Also see Black Burst and Color Burst.

● **Blackburst:** The video waveform without the video elements. It includes the vertical sync, horizontal sync, and the Chroma burst information. Blackburst is used to synchronize video equipment to align the video output.

● **Colour Burst:** In colour TV systems, a burst of subcarrier frequency located on the back part of the composite video signal. This serves as a colour synchronizing signal to establish a frequency and phase reference for the Chroma signal. Colour burst is 3.58 MHz for NTSC and 4.43 MHz for PAL.

● **Colour Bars:** A standard test pattern of several basic colours (white, yellow, cyan, green, magenta, red, blue, and black) as a reference for system alignment and testing. In NTSC video, the most commonly used colour bars are the SMPTE standard colour bars. In PAL video, the most commonly used colour bars are eight full field bars. On computer monitors the most commonly used colour bars are two rows of reversed colour bars.

● **Seamless Switching:** A feature found on many video switchers. This feature causes the switcher to wait until the vertical interval to switch. This avoids a glitch (temporary scrambling) which often is seen when switching between sources.

● **Scaling:** A conversion of a video or computer graphic signal from a starting resolution to a new resolution. Scaling from one resolution to another is typically done to optimize the signal for input to an image processor, transmission path or to improve its quality when presented on a particular display.

● **PIP:** Picture-In-Picture. A small image within a larger image created by scaling down one of image to make it smaller. Other forms of PIP displays include Picture-By-Picture (PBP) and Picture- With-Picture (PWP), which are commonly used with 16:9 aspect display devices. PBP and PWP image formats require a separate scaler for each video window .

●**HDR**: is a high dynamic range (HDR) technique used in imaging and photography to reproduce a greater dynamic range of luminosity than what is possible with standard digital imaging or photographic techniques. The aim is to present a similar range of luminance to that experienced through the human visual system.

●**UHD**: Standing for Ultra High Definition and comprising 4K and 8K television standards with a 16:9 ratio, UHD follows the 2K HDTV standard. A UHD 4K display has a physical resolution of 3840x2160 which is four times the area and twice both the width and height of a HDTV/FullHD (1920x1080) video signal.

●**EDID**: Extended Display Identification Data. EDID is a data structure used to communicate video display information, including native resolution and vertical interval refresh rate requirements, to a source device. The source device will then output the provided EDID data, ensuring proper video image quality.

6.2 Revision History

The table below lists the changes to the User Manual.

Format	Time	ECO#	Description	Principal
V1.0	2023-03-01	0000#	Release	Aster
V1.1	2023-07-21	0001#	Add 2U dimension drawing	Aster

All information herein is Xiamen RGBlink Science & Technology Co Ltd. excepting noted. **RGBlink** is a registered trademark of Xiamen RGBlink Science & Technology Co Ltd. While all efforts are made for accuracy at time of printing, we reserve the right to alter otherwise make change without notice.