

# Saramonic

Sound.Remarkable. 

UHF Wireless Microphone System  
无线麦克风系统

**UwMic9**  **Mini**

User Manual  
用户手册

## Statement

Please read this manual carefully before use and operate and store in strict accordance with the instructions provided. Please retain for future reference.

For any issues that cannot be resolved with the user manual, please refer to your retailer for help or contact us at: **info@saramonic.com**.

## Cautions

1. Take care not to use the unit underwater or unprotected in rainy conditions. Store in a cool, dry place.
2. Designed for use and storage at normal temperatures. Do not move the unit from overheated to cold conditions frequently, and keep away from heat sources such as heaters and ovens.
3. When in use, or when storing, avoid contact with dust and moisture.
4. Do not subject to device to violent collisions, as this can damage the device.
5. In order to avoid acoustic feedback, do not hold the microphone close to loudspeakers.
6. For optimal sound detection, do not hold your hand against the microphone head.



## General Introduction

The Saramonic UwMic9S Mini wireless microphone system provides a premium 2-person wireless audio solution for Broadcast & TV, ENG, filmmakers, vloggers, mobile journalists and content creators. It is an easy-to-use, high-quality and flexible UHF system. The system can be powered through its USB-C ports, allowing it to run for numerous hours on a USB-C 5V power bank.

## UwMic9S RX Mini Portable Receiver

### Introduction

The Saramonic UwMic9S RX Mini is a camera-mountable dual-channel UHF wireless receiver. It features wide switching RF bandwidth, a high-contrast OLED display and infrared synchronization between transmitter and receiver. The two detachable antennas can be rotated 360° for best possible reception. The receiver's output can be toggled between mono and stereo modes.

### Product Structure

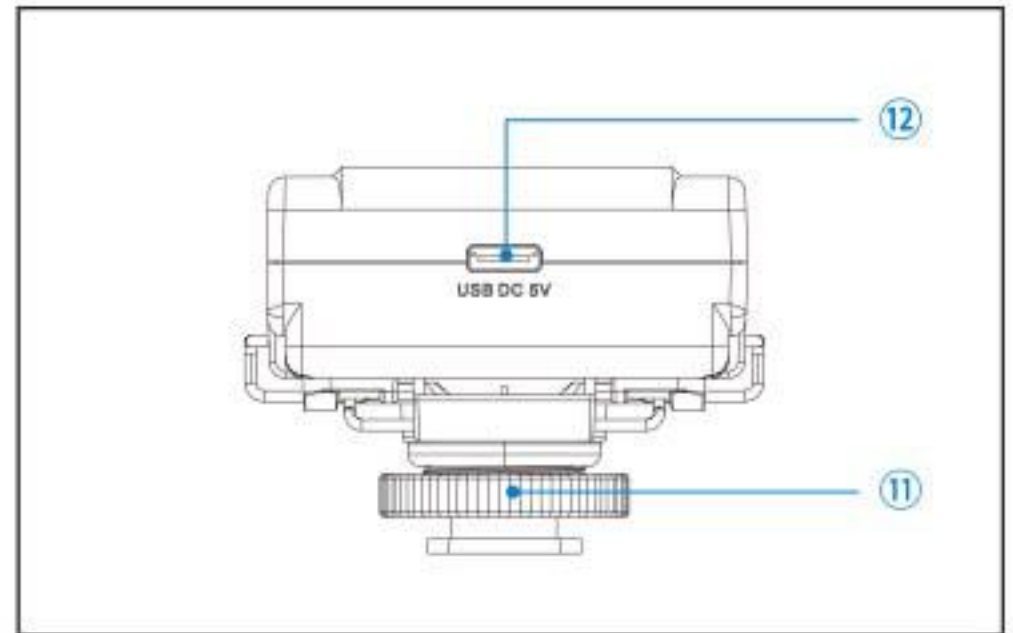
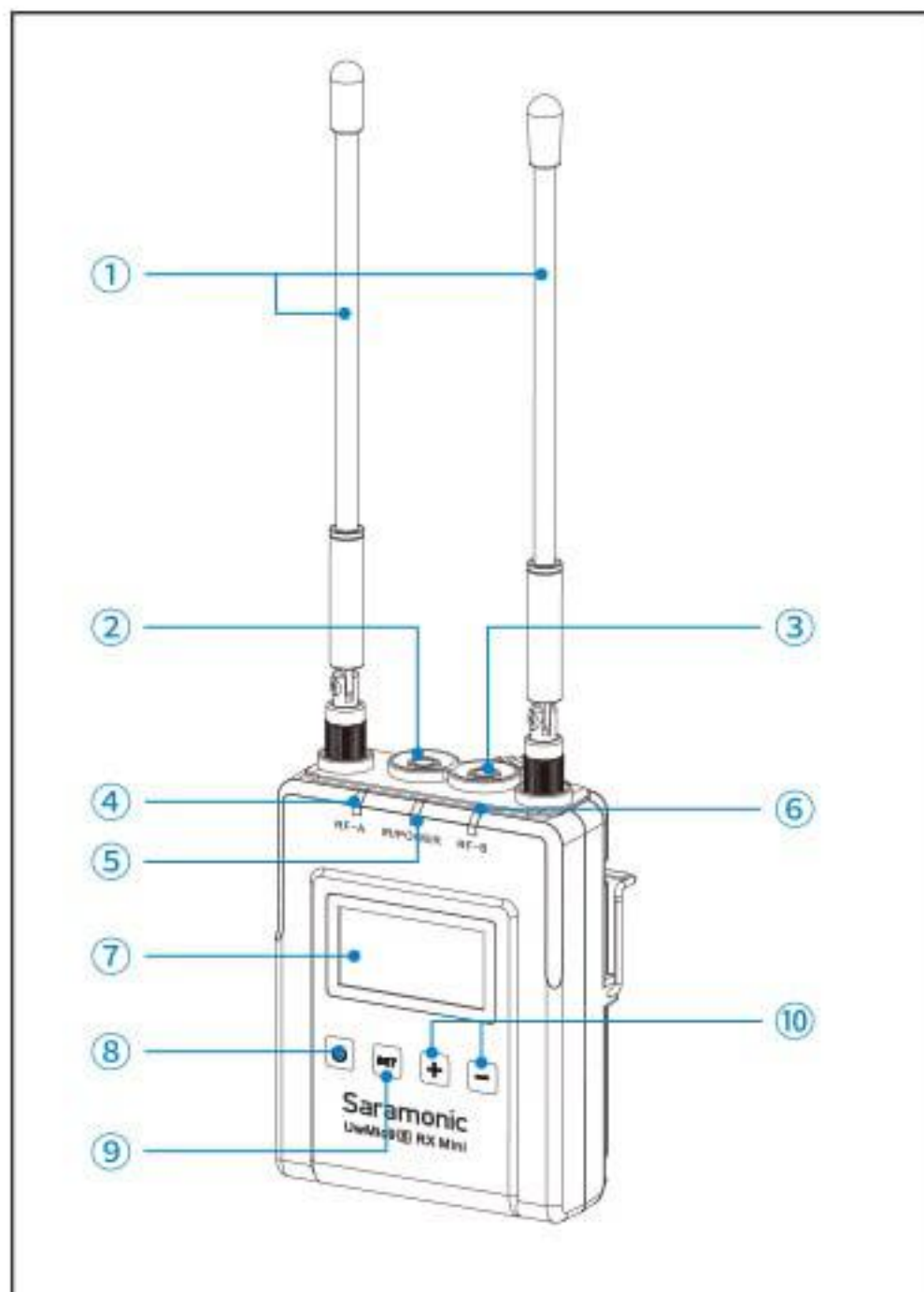

- ① **Detachable antennas**
- ② **3.5mm headphone output**  
Connect headphones to monitor the audio.
- ③ **Output jack**  
Connect the RX to a video camera, camcorder, mixer or amplifier with the supplied output cables.
- ④ **RF-A indicator**  
The RF indicator displays the RF input level of group A as follows:  
Solid Blue: Successfully matched.  
Lights off: RF signal is disconnected.
- ⑤ **IR/POWER indicator**  
Indicates the battery level as follows:  
Solid blue: Sufficient battery level.  
Solid Red: Battery low.  
Charging Status:  
Flashing Red: Charging.  
Solid Blue: Fully charged.
- ⑥ **RF-B indicator**  
The RF indicator displays the RF input level of group B as follows:  
Solid Blue: Successfully matched.  
Lights off: RF signal is disconnected.
- ⑦ **OLED display**  
Display menus, please refer to "OLED Display Operation Guide" (page 4) for more details.
- ⑧ **Power button**  
Long Press to turn the RX Mini on or off.
- ⑨ **SET button**  
Long press the SET button to change settings on the display menu.  
Then, short press the SET button to confirm your setting change, or long press again to exit without saving.
- ⑩ **+ or - button**  
Selects functions or values shown on the display.
- ⑪ **Cold shoe mount adapter**
- ⑫ **USB-C charging port (DC 5V)**



## Attaching Accessories

Connect the supplied cable to the output jack.

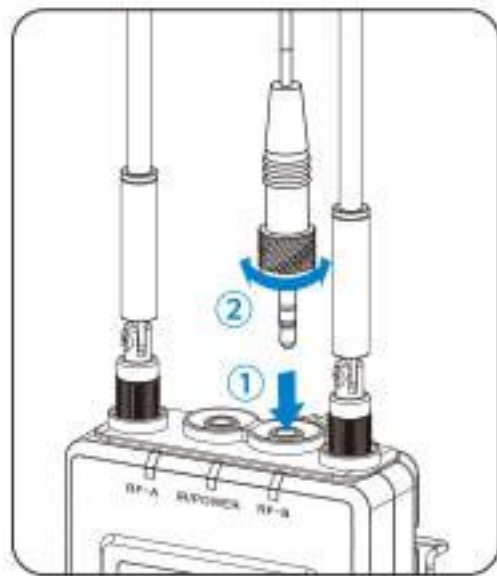

- ① Choose the corresponding cable and plug into the OUTPUT jack.
- ② For a secure connection, turn to lock the connector.

It is possible to attach a belt clip. Please Refer to "Attaching Accessories" (page 7).

Attaching the shoe mount adapter.

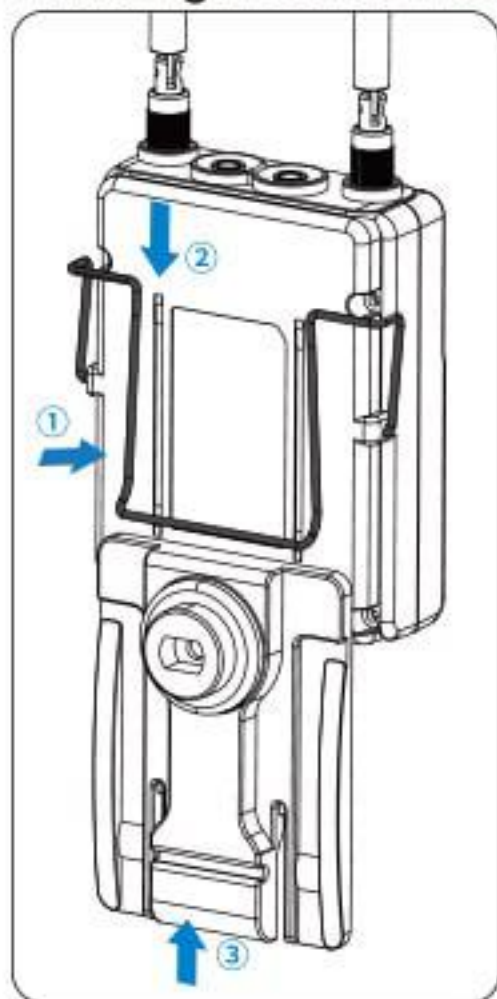

- ① Please attach the belt clip upside-down before attaching the shoe mount adapter.
- ② Press the bottom of the belt clip to make some space between the belt clip and the receiver.
- ③ Align the belt clip with the two vertical grooves on the shoe mount adapter and insert the adapter in the direction of the arrow.

- ④ Push the shoe mount adapter in fully until the belt clip fits into the horizontal groove on the adapter's holder.

## OLED Display Operation Guide

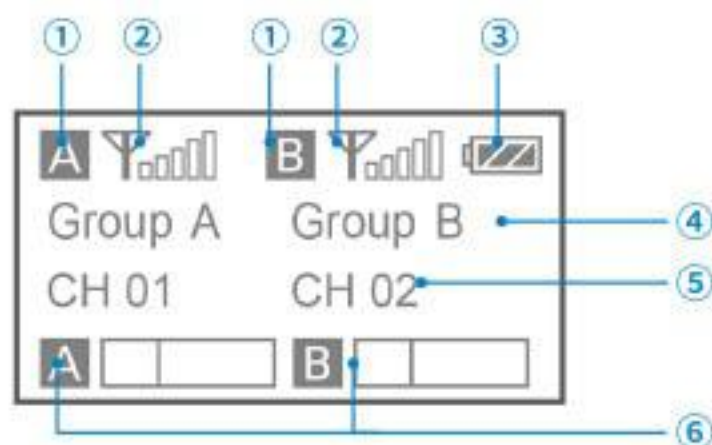

**Home screen:** If no operation is performed for 20 seconds on the other screens, the display will automatically return to the home screen.

- ① **Group icon**
  - Ⓐ Indicates the power of group A is turned off.
  - Ⓑ Indicates the power of group A is turned on.
- ② **RF level indicator**  
Indicates the current reception level.
- ③ **Battery level indicator**  
Displays the battery level. Please charge the devices immediately as soon as the indicator starts flashing.
- ④ **Name of the channel group**
- ⑤ **Current channel**  
Displays the current channel number.
- ⑥ **Audio input level meter**  
Displays the audio input level.

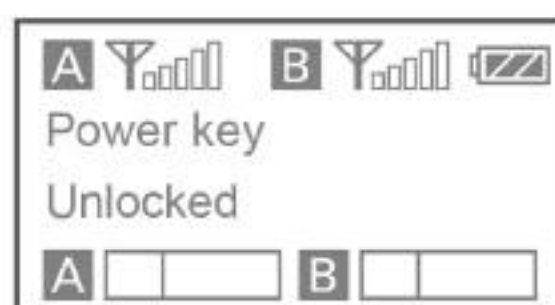

**Power key:** Long press the SET button to unlock or lock the power key. Lock the power key to prevent the receiver being turned off accidentally while in use.

- **Unlocked:** Long press the power key to turn the receiver on or off (System default).
- **Locked:** The receiver will not be turned off even after the power key is pressed.



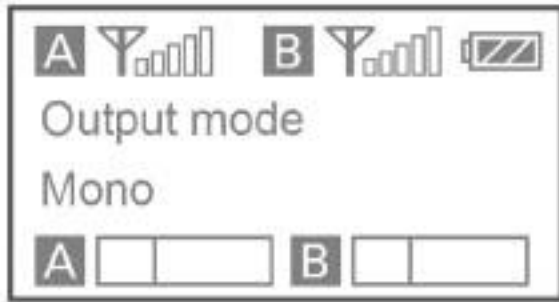

**Output mode:** The output mode can be set to mono or stereo. When the output mode is in mono, the audio from the left and right channel will be mixed. When in stereo, channel A's and channel B's audio output will be separated to the left and right of the stereo output.

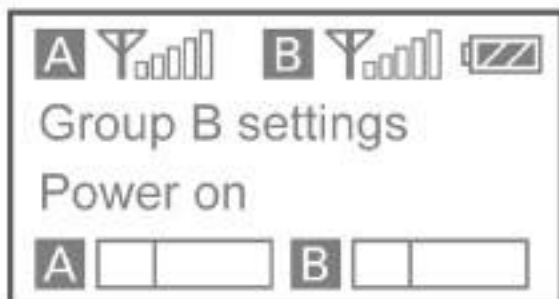
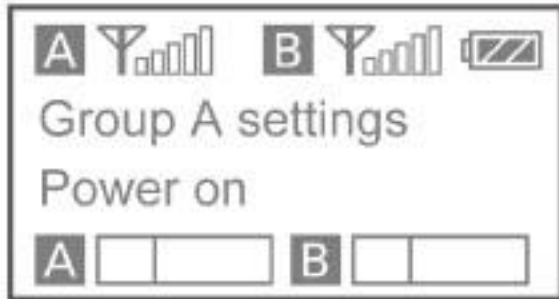

**Channel ON/OFF setting:** You can turn the channel A/B on/off according to your needs.

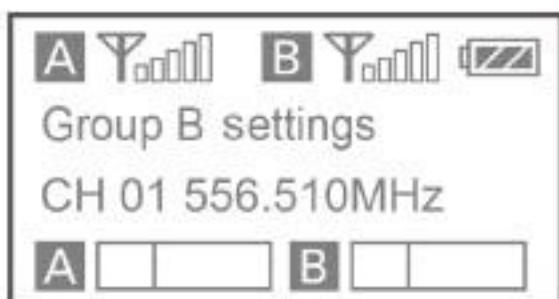

**Select channel:** For details of operation, please refer to "Manually setting the receiver channel" (page 10).

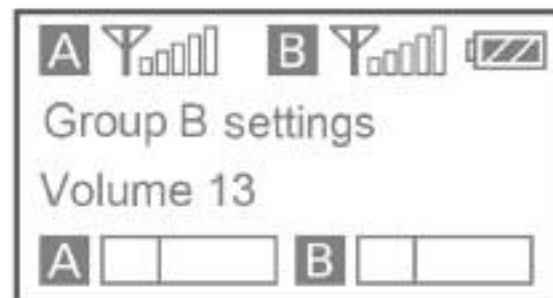
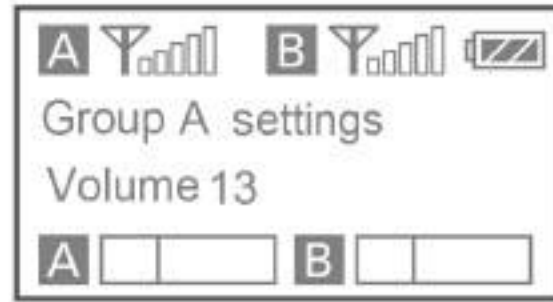

**Set output volume:** Set the volume of output audio within the range of 0 to 15. The setting is retained even after the power is turned off. Default volume is 13.

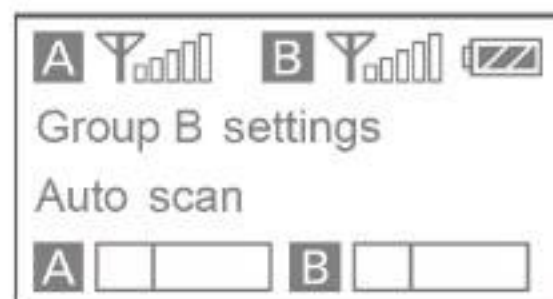
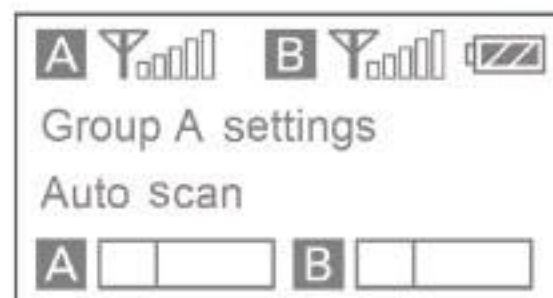

**Auto scan function:** Automatically scan an available and clear channel. For details of operation, please refer to "Using the auto scan function" (page 9).

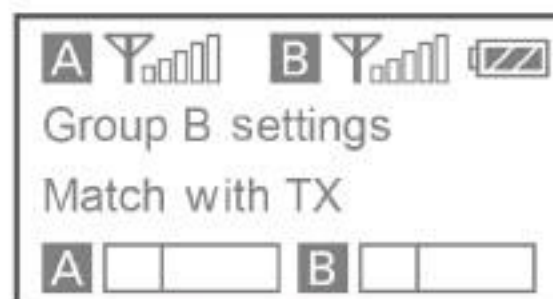
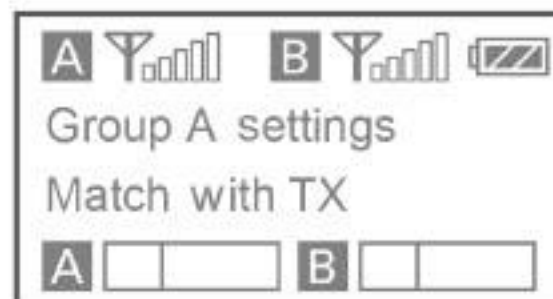

**Infrared matching function:** Match the receiver and transmitter via infrared. For details of operation, please refer to "Matching the receiver and transmitter channel" (page 10).

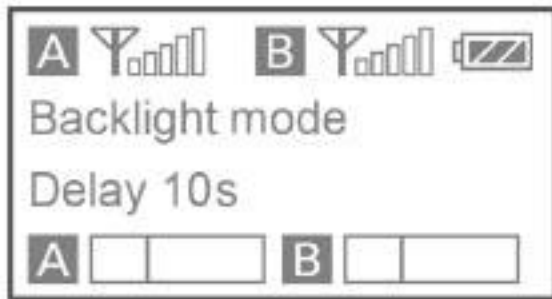

**Set backlight:** Set the background LED light to ON or Delay by 60, 30, or 10 seconds. Default setting is "Delay 30s."

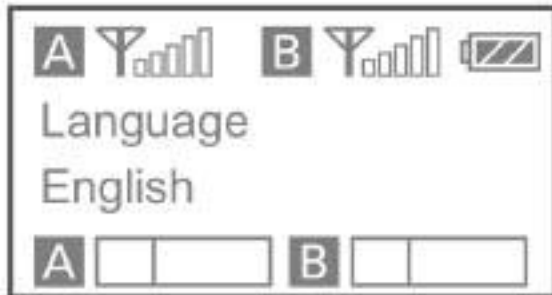

**Language Setting: English/ 中文 (Chinese)**  
Default is English

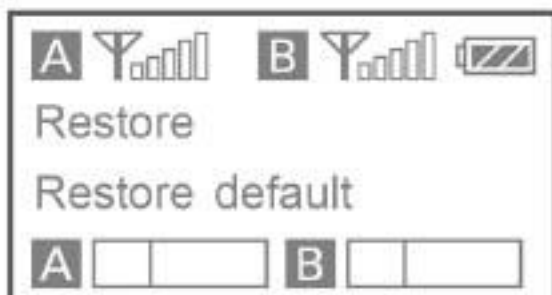

**Restoring default setting**

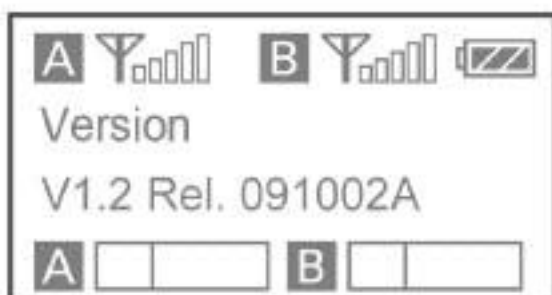

**UwMic9S RX Mini Version**

## Body-pack Transmitter UwMic9S TX Mini

### Introduction

The Saramonic UwMic9S TX Mini is a compact body-pack wireless transmitter. It features an easy-to-read OLED display, a detachable antenna and mute function. With a line/mic input jack, it can accept audio from the included 3.5mm locking lavalier mic or other line-level devices. In addition, the locking function prevents the transmitter from being turned off accidentally. Its compact size makes the UwMic9S TX Mini easier to be attached and carried around.

### Product Structure

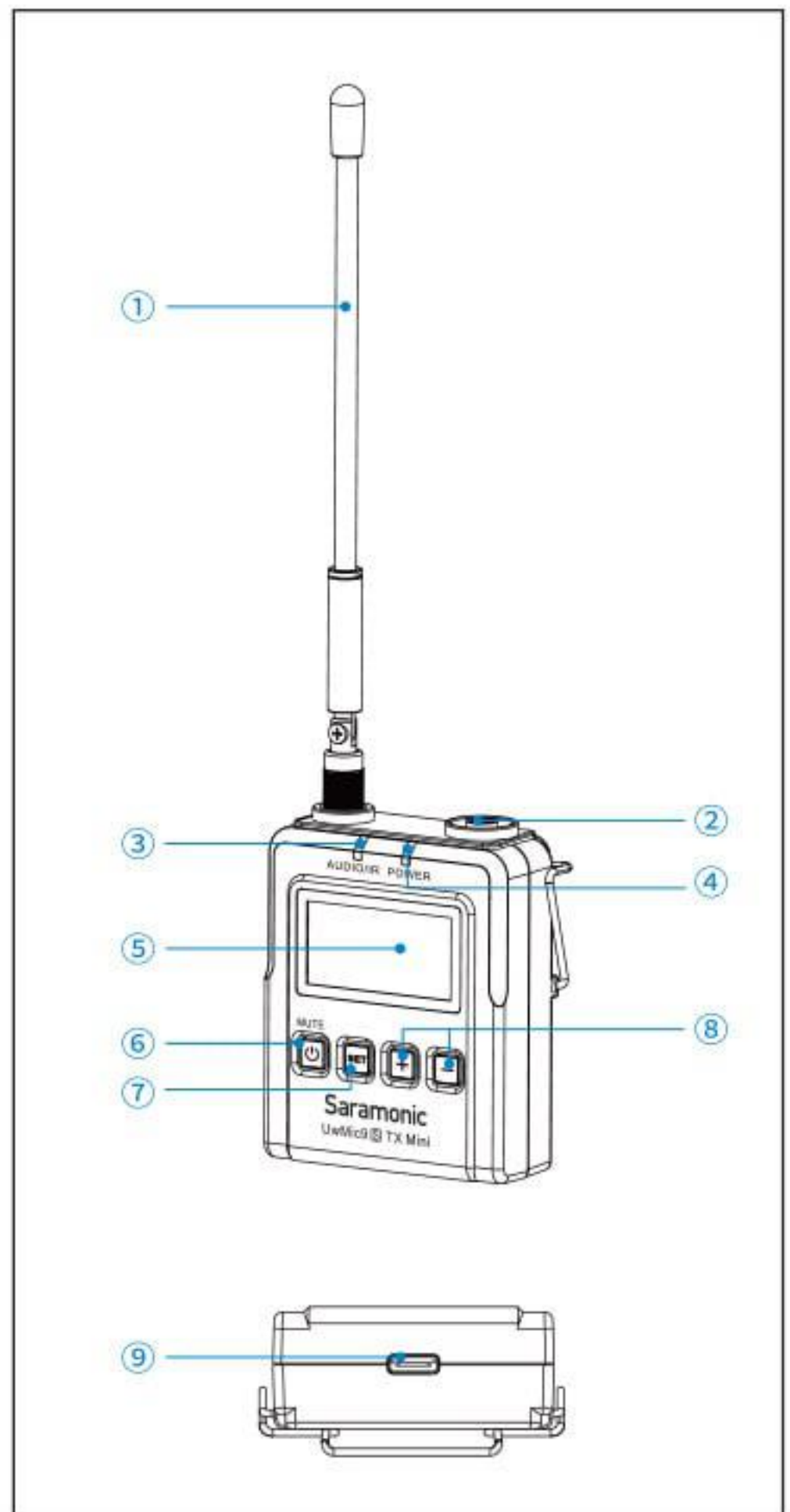



- ① **Detachable antenna**
- ② **LINE IN /MIC IN jack**  
3.5mm line in/mic in locking jack.  
Connect to a 3.5mm microphone or line-level devices.
- ③ **AUDIO indicator / IR (infrared detector)**  
AUDIO indicator: Indicates the audio input level. IR (infrared detector): Receives the frequency from the receiver.  
Solid Blue: Audio input level is appropriate.  
Flashing Red: Audio is muted. For details on setting the mute function, please refer to "Set Mute key" (page 8).
- ④ **POWER indicator**  
Indicates the battery level as follows: Solid Blue: Sufficient battery level.  
Solid Red: Low battery.  
Charging Status:  
Flashing Red: Charging.  
Solid Blue: Fully charged.
- ⑤ **OLED display**  
For display menus, please refer to the "OLED Display Operation Guide" (page 8) for more details.
- ⑥ **Power / Mute button**  
Power ON:  
Press button for one second or longer  
Power OFF:  
Press button until it turns off  
Mute ON/OFF:  
Short press button
- ⑦ **SET button**  
Long press the SET button to enter the displayed menu. Then, short press the SET button to confirm your option or long press again to exit without saving.
- ⑧ **+ or - button**  
Selects functions or values shown on the display.
- ⑨ **USB-C charging port (DC 5V)**

## Attaching Accessories



### 1. Attaching a belt clip

Insert one end of the belt clip into one of two holes on either side of the transmitter, and then insert the other end into the hole on the other side.

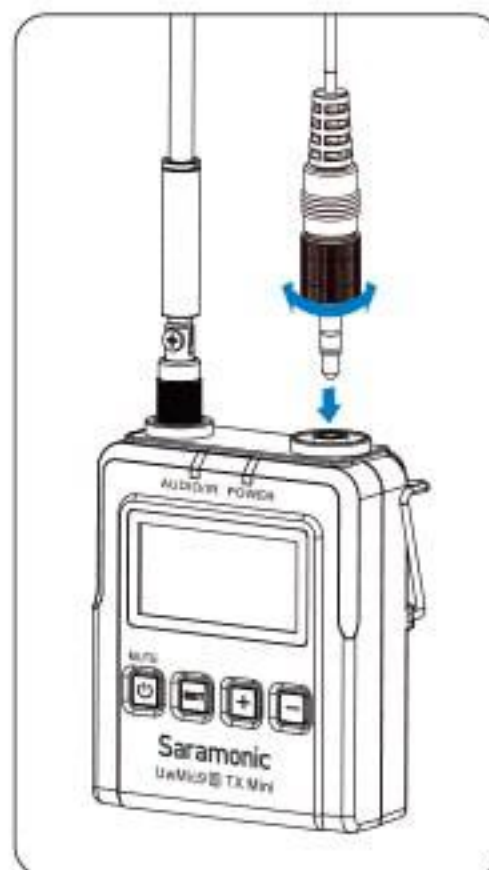

### 2. Connecting the microphone

For a secure connection, turn to lock the connector.

**Note:** Please turn off the transmitter before attaching or removing the microphone.



## OLED Display Operation Guide

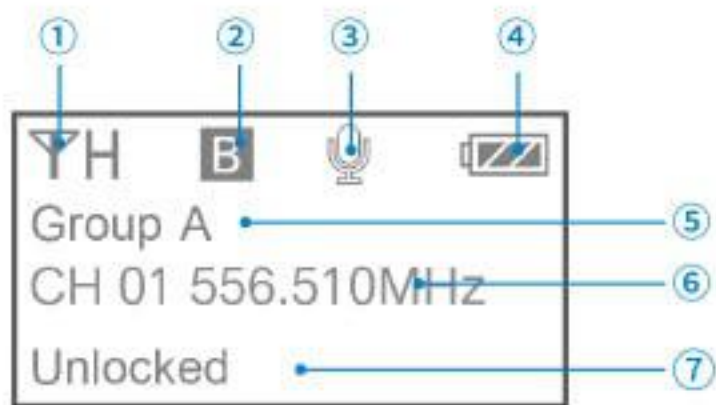

**Home screen.** If no operation is performed for 20 seconds on the other screens, the display will automatically return to the home screen.

- ① **RF transmission power indicator:**  
indicates the current transmission power level.  
For details on setting the level, please see "Select RF power level" (page 8).
- ② **Channel group indicator:**  
indicates the current group.
- ③ **Mute indicator:**  
Mute OFF    Mute ON
- ④ **Battery level indicator:**  
Displays the battery level. Please recharge the device immediately as soon as the indicator starts flashing.
- ⑤ **Name of the channel group**
- ⑥ **Channel and frequency:**  
Indicates the current channel and frequency.
- ⑦ **The status of Power / Mute button.**
- ⑧ **Menu display section.** Displays various functions. Press the + or - button to switch functions.



**Set Power key:** Select Unlocked or Locked. Set "Locked" to lock the power button to prevent the unit from being turned off accidentally while in use. Default is "Unlocked."



**Select Channel:** Long press the SET button to enter the menu. Use the "+" and "-" to select the channel you need and short press the SET button to confirm.



**Select Group:** You can choose "A" or "B" channel group. Each group has 96 channels. The default is "Group A."



**Select RF power level:** You can set the transmitted RF power to High, Medium or Low. The default is "High."



**Set Mute key:** If you want to mute the audio, please select "Enable" first and then short press the power button. If "Disable" selected, mute function will be disabled. Short press the power button won't mute the product. The default is "Enable."



**Select Input mode:** You can choose "Line in" or "Mic in" according to your needs. The default is "Mic in".





**Microphone Gain Setting:**

If you want to adjust the microphone's gain, you can set the microphone's gain from 00-08. The default is "05".



**IR Match:** Set to match with the receiver. The screen will display "Matching" when in process. After successful matching, it will read Match success. If failed to be matched within 20s, the screen displays "Match time out"

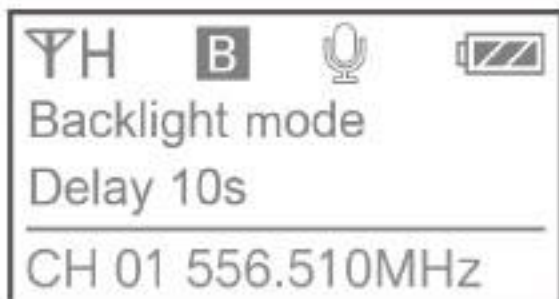

**Set Backlight:** Select ON or Delay by 10, 30, or 60 seconds. The default is "Delay 30s."

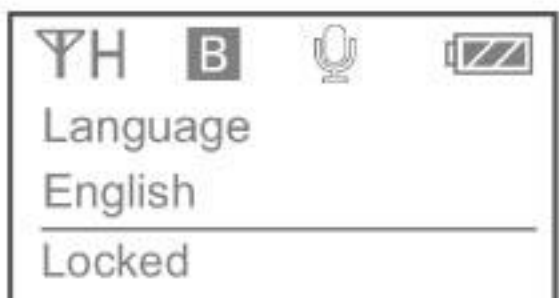

**Language Setting: English/ 中文 (Chinese)**  
Default is English



**Restore default setting**

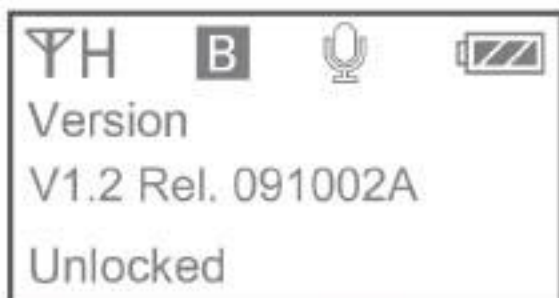

**UwMic9S TX Mini Version**

**Operation Guide**

1. Connect the receiver to the microphone input of a camera, camcorder or mixer with the supplied cable.

2. Turn on the receiver by long pressing the power button.

3. Set the channel of the receiver in two ways:

① By using the auto scan function

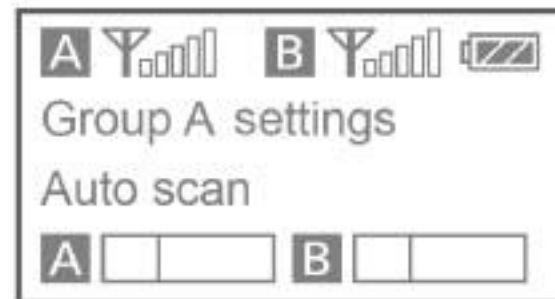

Using the + or - button to display the auto scan screen on the receiver.

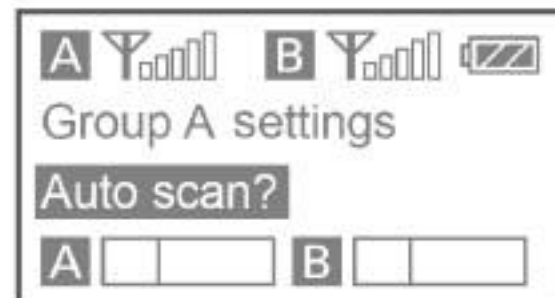

Long press the SET button to select "Auto scan?"

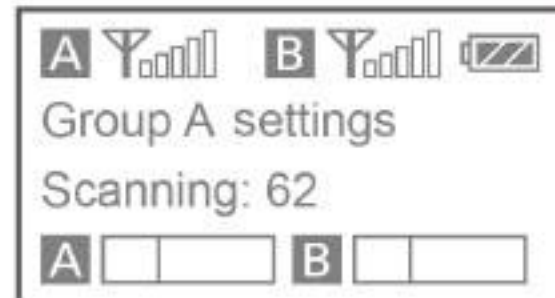

The channel with the least noise and interference will be displayed.

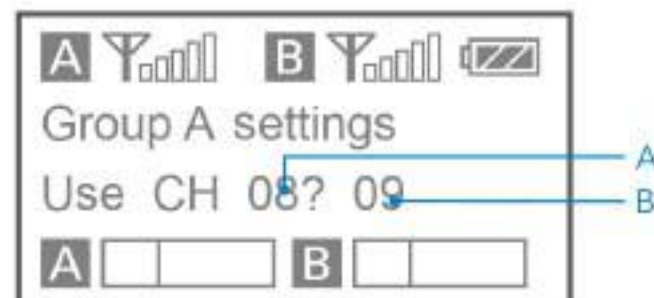

Press the SET button to confirm.

A. Indicates that the current channel with the least noise is CH 08 and asks you if you would like to use it. You can short press the SET button to confirm the channel within 20 seconds or long press the SET button to exit the displayed menu without saving.

B. 20 seconds Countdown



**Note:**

- ① After 20 seconds have elapsed, the display returns to the home screen without saving.
- ② Some noise may occur when power is turned on, so it is possible to turn down the audio input level of devices connected to the receiver accordingly.

② Manually setting the receiver channel:  
Use the + or - button to display the channel menu on the receiver.

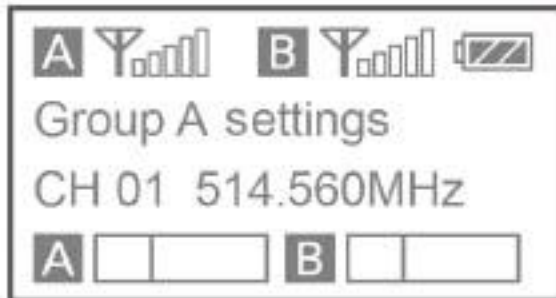

Long press the SET button to select the menu.

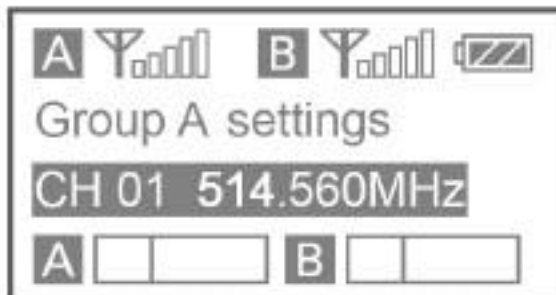

Use the + or - button to select the desired channel and confirm it by short pressing the SET button.

**4. Matching the receiver and transmitter channel:**

① Matching by infrared transmission: infrared transmission is used to transfer the frequency set on the receiver to a transmitter.

- Turn on the transmitter and receiver.
- Use the + or - button to display the "Match with TX" menu on receiver.

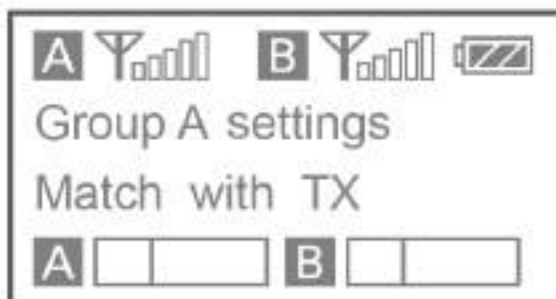

- Use the + or - button to display the "Match with RX" menu on transmitter.



- Long press the SET button to select the menu and then short press it to confirm.
- Place the infrared transmitter port (the IR indicator) of the receiver near the infrared detector (the IR indicator) of the transmitter.
- If "Sync Finished" is displayed on the OLED screen, the frequency for use on the transmitter is set.
- After matching successfully, the RF indicator of the receiver will be in solid blue. The display will automatically return to the home screen.

② Manually setting the transmitter channel  
Use the + or - button to display the channel menu on the transmitter.



Long press the SET button to select the menu.



Use the + or - button to select the same channel as the receiver, and confirm it by short pressing the SET button.

After matching successfully, the RF indicator of the receiver will be in solid blue.



## Specification

### Receiver UwMic9S RX Mini

Channel number	96
Channel group	A and B
Oscillator type	PLL synthesizer
Operating range	Up to 328'(100m)
Audio output connector	3.5mm headphone output 3.5mm output jack
Antenna	1/4λ wire antenna
Audio output level	-60 dBV
Headphone output level	30mW (16 Ω)
Carrier frequencies	514 MHz - 596 MHz
Sensitivity	-95 dBm
Signal-to-noise ratio	75 dB or more
Reference deviation	±5 kHz (-60 dBV, 1 kHz input)
Frequency response	40 Hz to 18 kHz (+/-3dB)
Distortion	0.2% or less
Built-in battery capacity	2000mAh
Power requirements	Built-In Li-ion Battery or USB-C DC 5V
Continuous working time	Approx. 8hrs
Dimensions	78x58x25 mm
Weight	138g(4.87oz)
Operating temperature	-10 °C to 50 °C
Storage temperature	-20 °C to +55°C

### Transmitter UwMic9S TX Mini

Channel number	96
Channel group	A or B
Oscillator type	PLL synthesizer
Operating range	Up to 328'(100m)
Audio input connector	3.5mm jack (MIC IN /LINE IN jack)
Antenna	1/4λ wire antenna
Carrier frequencies	514 MHz - 596 MHz
RF output power	≤10mW
Signal-to-noise ratio	75 dB or more
Reference deviation	±5 kHz (-60 dBV, 1 kHz input)
Frequency response	40 Hz to 18 kHz (+/-3dB)
Distortion	0.2% or less
Reference audio input level	-60 dBV (MIC input, 0 dB attenuation)
Built-in battery capacity	1000mAh
Power requirements	Built-In Li-ion Battery or USB-C DC 5V
Continuous working time	Approx. 5hrs
Dimensions	62.8x50x21.8 mm

Weight	90g (3.17oz)
Operating temperature	-10 °C to 50 °C
Storage temperature	-20 °C to +55°C

## Packing List

### UwMic9S Kit1 Mini (TX Mini+RX Mini)

1×Body-pack Transmitter: UwMic9S TX Mini  
 1×Portable Receiver: UwMic9S RX Mini  
 1×DK3A Omnidirectional Lavalier Microphone  
 1×Locking 3.5mm TRS Male to XLR Male Audio Cable (0.5m)  
 1×Locking 3.5mm TRS to 3.5mm Right-Angle TRS Audio Cable for Camera (0.3m)  
 2×Type-C to USB-A Charging Cable (1.2m)  
 1×Mic Clip  
 1×Foam Windscreen  
 1×Fur Windshield  
 3×Antenna  
 2×Belt Clip  
 1×Cold Shoe Mount Adapter  
 1×SR-C6 Toolbox

### UwMic9S Kit2 Mini (TX Mini+TX Mini+RX Mini)

2×Body-pack Transmitter: UwMic9S TX Mini  
 1×Portable Receiver: UwMic9S RX Mini  
 2×DK3A Omnidirectional Lavalier Microphone  
 1×Locking 3.5mm TRS Male to Dual XLR Male Audio Cable (0.5m)  
 1×Locking 3.5mm TRS to 3.5mm Right-Angle TRS Audio Cable for Camera (0.3m)  
 3×Type-C to USB-A Charging Cable (1.2m)  
 2×Mic Clip  
 2×Foam Windscreen  
 2×Fur Windshield  
 4×Antenna  
 3×Belt Clip  
 1×Cold Shoe Mount Adapter  
 1×SR-C8 Toolbox