

XC7

User Manual

February 22, 2026

SKUs: XC7-V4

Language: English

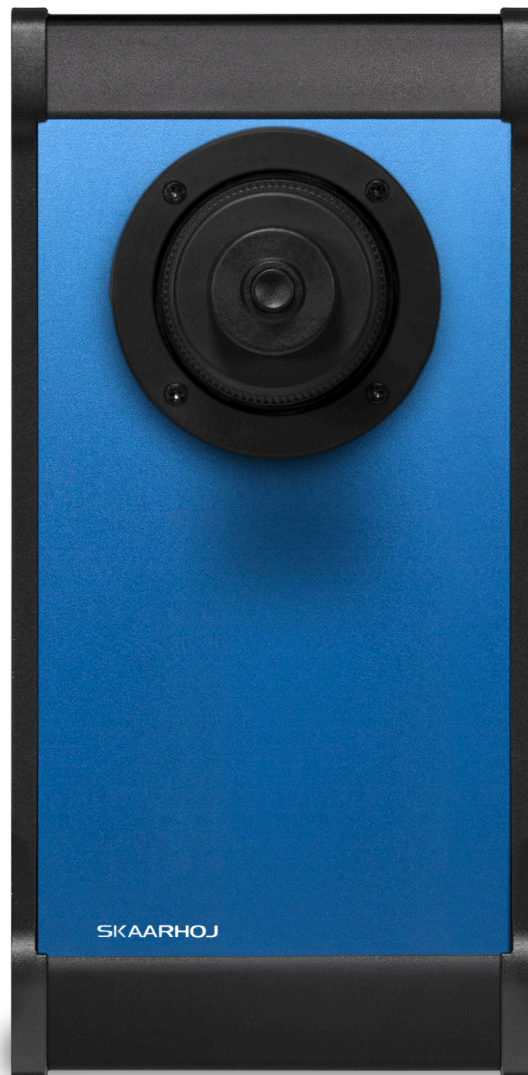

I Disclaimer

Before using this product, please read and fully understand all instructions provided. This product is classified as Class A equipment and is intended for use by commercial customers only. It is not suitable for residential use and may cause interference in residential environments.

For the most up-to-date specifications, refer to the latest SKAARHOJ data sheets or publications. Availability of products and types may vary by country —please check with a SKAARHOJ sales representative for details.

The information in this document is subject to change without notice. While SKAARHOJ strives to ensure the quality, reliability, and safety of its products, defects cannot be entirely ruled out. To minimize risks of damage or injury, customers must implement appropriate safety measures and follow the intended use guidelines.

SKAARHOJ and its subsidiaries disclaim any liability, warranty, or responsibility for claims, whether in contract, tort, or any other legal theory. SKAARHOJ shall not be liable for any special, direct, indirect, incidental, or consequential damages, including lost profits, revenues, or economic losses, or for third-party claims, equipment replacement, or any other damages.

SKAARHOJ does not assume liability for patent, copyright, or intellectual property infringement arising from the use of its products. No license or rights are granted under any patents or intellectual property of SKAARHOJ or third parties.

If any of the above clauses are not permitted by applicable law, they will be enforced to the maximum extent allowed.

II Imprint

© 2026 SKAARHOJ. All rights reserved.

This device contains proprietary information of SKAARHOJ and is provided under a license agreement with restrictions on use and disclosure, protected by copyright law. Reverse engineering of the hardware and software is prohibited.

No part of this publication may be distributed, reproduced, transmitted, transcribed, stored in a data retrieval system, or translated into any language in any form by any means without prior written permission from SKAARHOJ.

If you download files from our website for personal use, ensure you check for updated versions. SKAARHOJ cannot be held liable for downloaded files, as technical data is subject to change without notice.

Due to ongoing product development, the information in this document may change without notice. The information and intellectual property contained herein is confidential between SKAARHOJ and the client and remains SKAARHOJ's exclusive property. Please report any issues with the documentation in writing. SKAARHOJ does not guarantee this document is error-free.

The source language of this manual is English. Translations into other languages are derived from the English version.

For further assistance:

SKAARHOJ ApS
Rosenkaeret 11C
DK-2860 Soeborg
Denmark
Email: info@skaarhoj.com
Website: www.skaarhoj.com

II.1 Trademarks

SKAARHOJ® is a registered trademark of SKAARHOJ ApS. The following names are also trademarks of SKAARHOJ: Raw Panel™, Blue Pill™, Reactor™, UniSketch™, Device Core™, and XC7™.

All other trademarks are the property of their respective owners and are acknowledged as such.

III Document Legends

This section explains the meaning of various alert levels and informational notes used throughout this document. Each label serves as a guide to indicate the level of attention required and the type of risk involved. Please review these legends carefully to ensure a clear understanding of the warnings, cautions, and helpful tips provided.

Danger

DANGER indicates an imminent hazard. Failure to avoid it will result in death or serious injury. Always follow the recommended actions to prevent this danger.

Warning

WARNING indicates a potential hazard. Failure to avoid it may result in death or serious injury. Always follow the recommended actions to prevent this risk.

Caution

CAUTION indicates a possible hazard. Failure to avoid it may result in minor or moderate injuries. Always follow the recommended actions to prevent this hazard.

Notice

NOTICE indicates a potential risk of equipment or environmental damage. Always follow the recommended actions to avoid damage.

Hint

HINT provides additional information to clarify or simplify a procedure. It is not related to safety.

Contents

I Disclaimer	1
II Imprint	2
II.1 Trademarks	2
III Document Legends	3
1 About this Document	5
2 Safety Information	6
3 About XC7	7
3.1 Feature Highlights	7
3.2 Intended Use	7
3.3 Product Identification	8
3.4 Environmental Conditions	8
3.5 Technical Data and Dimensions	8
3.5.1 Standard Connections	8
3.5.2 Functional Earth	9
3.5.3 Technical Drawing	9
3.5.4 Technical Data	9
3.5.5 Hardware Components	9
3.6 Scope of Delivery and Warranty	10
3.6.1 Recommended Accessories	10
3.7 Certification and Safety Standards	12
3.7.1 EU Declaration of Conformity	12
4 Getting Started with Link IO	13
4.1 Quick Steps	13
4.2 SKAARHOJ Discovery	13
4.3 Configuration via USB	14
4.4 Accessing the Web Interface	16
4.4.1 Network Settings	17
4.4.2 Managing Configurations	19
4.5 Firmware Updates	20

4.5.1	New Firmware Releases	20
4.5.2	Factory Reset	21
4.5.3	Wrong Firmware	22
4.5.4	Upgrading to the Link IO Platform	23
4.6	Serial Monitor	27
4.7	Raw Panel over USB Serial	29
5	XC7 Functionality	30
5.1	Network Tab	30
5.2	Raw Panel Tab	30
5.3	Joystick Tab	31
6	Service	33
6.1	Troubleshooting	33
6.2	Cleaning	33
6.3	Repair	34
6.4	Disposal	35
6.5	Transportation and Storage	35
6.6	SKAARHOJ Service Contacts	36
7	Notes	37

1 About this Document

This operating manual is intended for all users of the SKAARHOJ XC7. It provides essential guidelines for safe and proper operation of the device. All users must read this manual before using the device for the first time to ensure correct usage.

The manual is an important part of the XC7 and should be kept easily accessible, close to the device for reference at any time.

For more detailed information about the device's features and functionality, please refer to additional instructions available for download at www.skaarhoj.com or request them via support@skaarhoj.com.

Ensure that the operating manual, user manual, and any other relevant documentation are stored safely for future reference and for any potential future users of the device.

For more resources and helpful information, visit the SKAARHOJ website.

SKAARHOJ offers comprehensive training courses to provide deeper insights into maximizing the potential of SKAARHOJ products.

2 Safety Information

This safety information supplements the specific operating instructions and must be strictly followed. Before operating or installing the device, read and understand all safety and operating instructions. Keep these instructions for future reference. Always follow the guidelines in this and any other documentation provided to avoid injury or damage to the device and surrounding objects.

Assembly and operation should only be performed by trained personnel familiar with the device. Use only the recommended tools, materials, and procedures outlined in this document. For other equipment, refer to the manufacturer's instructions.

Safety instructions, warning symbols, and signal words in this document highlight different levels of risk.

Caution

Using XC7 in Humid Environments with Condensation

When moving the device and its accessories from a cool to a warm location, or when used in a damp environment, condensation may form inside the device and on electrical connections. Do not operate the device while condensation is present, as it poses a risk of electric shock and fire due to short circuits.

- Do not use the device or accessories if condensation occurs.
- After moving the device from a cool to a warm environment, allow time for the components to warm up.
- Store the device in a warmer location to reduce the risk of condensation.

Warning

Connected Cables on the Floor

Risk of injury from tripping, falling, or slipping over connected cables.

- Always secure cables connected to the device and accessories properly.
- Install cables in a way that prevents tripping.
- Use a cable duct or secure cables with adhesive tape if necessary.
- Always disconnect cables from the device and accessories before moving them.

3 About XC7

The XC7 is a sleek addition to SKAARHOJ's controller lineup, designed to easily add joystick control to existing setups. Featuring a 3-axis joystick with a reset button, it offers precise control over pan, tilt, and zoom functions. Its minimalist design focuses on functionality and ease of use, making it the perfect companion for other SKAARHOJ controllers.

With XC7 you enjoy benefits such as

- **Add-on Flexibility:** Easily integrates with existing SKAARHOJ panels, enhancing control without clutter.
- **Simple Yet Effective:** Focuses on essential joystick controls for pan, tilt, and zoom, streamlining operations.
- **Plug-and-Play:** Designed for quick integration and immediate use, reducing setup time.
- **Discreet Footprint:** Compact design allows it to fit into any setup without taking up valuable space.

3.1 Feature Highlights

- 3-axis joystick w/Homing button
- Designed to complement other SKAARHOJ controllers
- 100 Mbit Ethernet w/Power over Ethernet (PoE IEEE802.3af)
- UniSketch Platform w/Raw Panel Server mode
- Designed and made in Denmark

3.2 Intended Use

Notice

Intended Use of XC7

All versions of XC7, and accessories are intended for professional use only and must be operated by skilled and trained personnel in non-domestic environments. They must not be used by inexperienced individuals without proper training.

Before use, carefully read and understand both the operating and user manuals. Use the product and its accessories solely for the purposes outlined in this document. Always follow the safety instructions and system requirements for all equipment involved.

SKAARHOJ assumes no liability for damages or modifications resulting from improper use. Modifying the product or its accessories is strictly prohibited.

3.3 Product Identification

The XC7 is identified by a label located on the bottom of the device. This label contains important information such as certification marks, product code, and the serial number. Ensure this label remains intact for future reference and support.

3.4 Environmental Conditions

The XC7 must be used and stored under specific environmental conditions. Before commissioning and operation, ensure the following conditions are met:

Operating Temperature	0° C to +40° C / +32° F to +104° F
Storage Temperature	-20° C to +45° C / -4° F to +113° F
Humidity	90% RH, non-condensing, from -20° C to +45° C

3.5 Technical Data and Dimensions

3.5.1 Standard Connections

On most SKAARHOJ products, you will find the following cable connections on the backside:

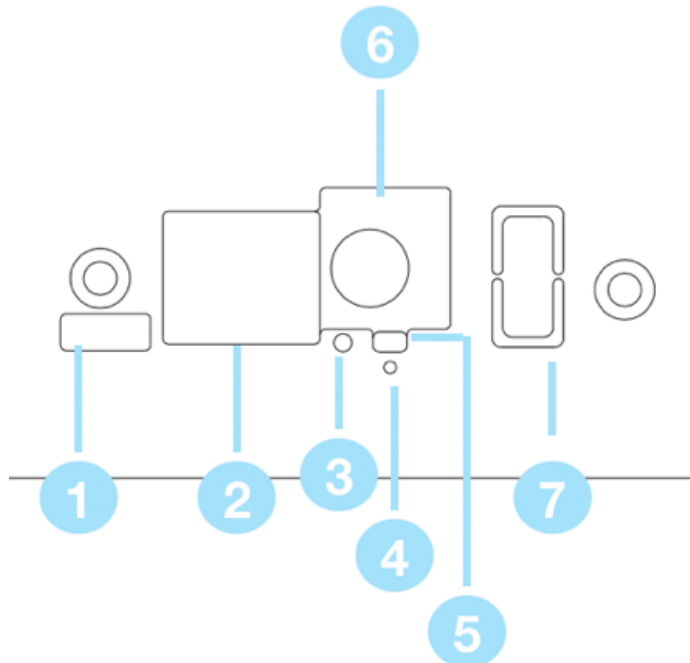

- **1:** Micro USB Port for serial communication with SKAARHOJ Firmware Updater
- **2:** IP Network RJ45 Port for IP control and 5W-15W PoE (+)/PoE Standard: IEEE 802.3af/t
- **3:** Status LED for monitoring and debugging
- **4:** Not used on Blue Pill Inside products.
- **5:** Config Button. Used to enable WiFi Access Point. See WiFi Access Point section
- **6:** 12V DC Power Supply for connection to the supplied DC power adaptor. Center is positive.
- **7:** USB-A Port. Only available on some models for attachment of accessories.

Notice

- Use only shielded Cat6 (STP) cables for Ethernet connections.
- Ensure that your Ethernet switch is properly connected to a protective earth ground.
- All cables, except Ethernet and GPI cables, must be shorter than 3 meters.
- If applicable: The USB-A port's power is not included in the product's maximum power rating. If near maximum load, use a powered USB hub to prevent the USB-A port from impacting the overall power budget.

3.5.2 Functional Earth

For EMC and ESD immunity, the enclosure must be connected to functional earth. Operation without this connection is outside the intended operating conditions and may result in degraded performance. While grounding through a shielded Ethernet cable connected to a properly grounded switch may be sufficient in some installations, the unit is tested for compliance using a dedicated grounding conductor attached to the grounding screw located above the Micro-USB port.

Connect the functional earth terminal on the enclosure to a suitable earth point using a short, low-impedance conductor (minimum 0.75 mm² / 18 AWG).

3.5.3 Technical Drawing

Figure 1 presents a detailed technical drawing of XC7, highlighting key dimensions and design elements.

3.5.4 Technical Data

Technical data for XC7 are presented in Table 1.

3.5.5 Hardware Components

The hardware components of XC7, along with their component IDs (HWc ID), are shown in Figure 2.

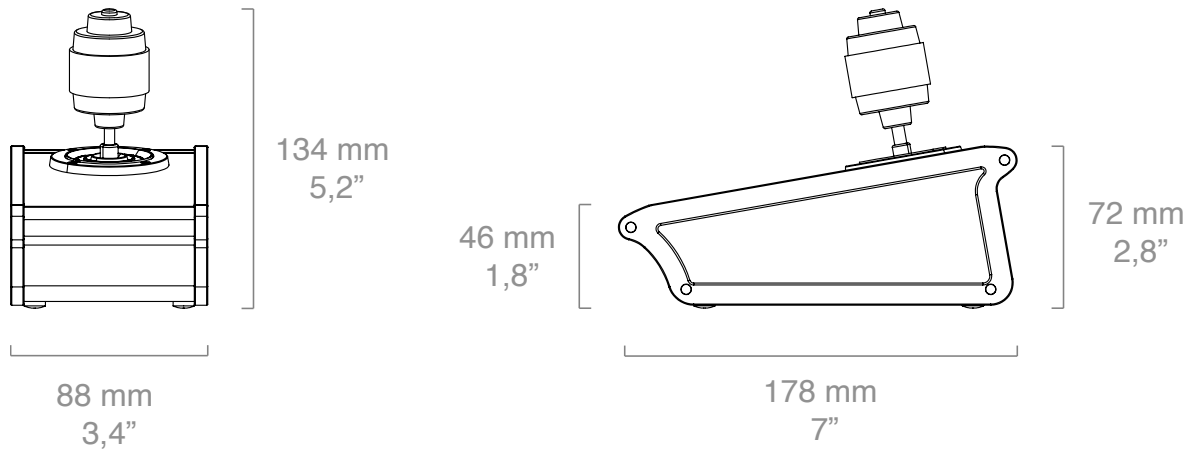

Figure 1: Technical drawing of XC7 with key dimensions and layout details.

3.6 Scope of Delivery and Warranty

Notice

Important Information:

The packaging materials are recyclable. To contribute to environmental sustainability, please dispose of the packaging at a certified recycling facility. Ensure that all storage, shipping, and disposal comply with local regulations. SKAARHOJ assumes no responsibility for any consequences arising from improper storage, shipping, or disposal of the product.

Upon receiving the delivery, carefully inspect the package and its contents for any signs of damage or missing components. Do not accept the delivery if the package is damaged or incomplete. The package should contain the following items:

- (This Product)
- 12V Power Supply: Manufacturer: PHIHONG, Model Name: PSA15R-120P, Output: 12V/1.25A, Cable Length: 1.5m, Adapter type: EU, GB, US, AU depending on shipping country, DC Output Connector: 5.5mm x 2.1mm x 10mm Center Positive
- Micro USB Cable
- Getting Started Guide

For details regarding the warranty, please contact your local SKAARHOJ Service Partner. SKAARHOJ is not liable for any issues arising from improper shipping, misuse, or the use of unauthorized third-party products.

3.6.1 Recommended Accessories

- Ethernet Cable: Cat 6 S/FTP or better

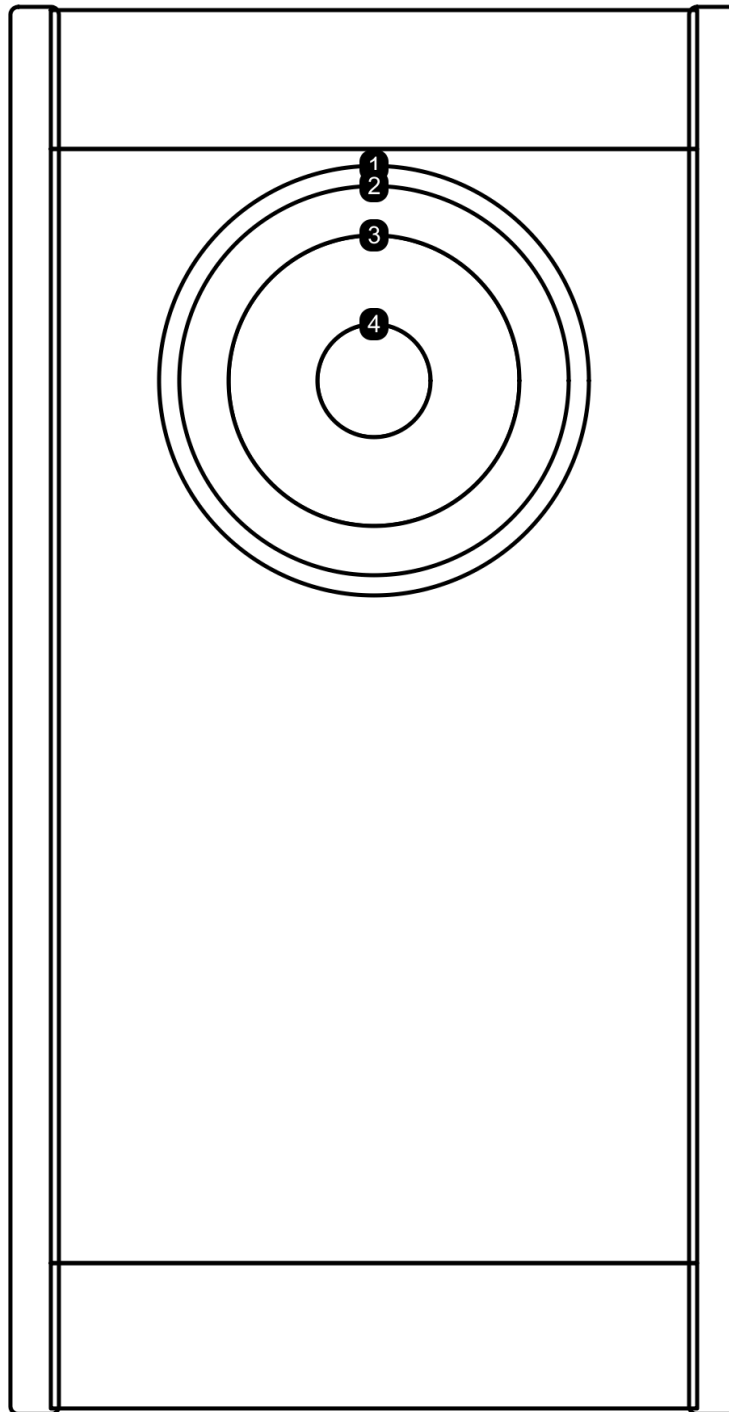

Figure 2: Diagram of hardware components for XC7 with component IDs (HwC ID)

Hardware Specifications	
Buttons	4-Axis Joystick, Top button (x1)
Analog Components	4-Axis Joystick, Left-Right (x1); 4-Axis Joystick, Up-Down (x1); 4-Axis Joystick, Rotate (x1)
Connectivity	
Networking	100 Mbit Ethernet w/Power over Ethernet (PoE IEEE802.3af)
Power Supply	12V DC Jack 5.5mm x 2.1mm x 10mm Center Positive PoE IEEE802.3af/t
Service Port	Micro USB for updating firmwares and setting manual IP
Software	
Platform	UniSketch (Raw Panel Server, Legacy Device Cores)
Licenses	N/A
Physical and Shipping	
Product Weight	572 g
Shipping Box Weight	1623 g
Country of Origin	Denmark

Table 1: Detailed specifications and technical characteristics for XC7

3.7 Certification and Safety Standards

3.7.1 EU Declaration of Conformity



Brand Name

Product Description

SKAARHOJ
Universal Control Panel
XC7

4 Getting Started with Link IO

4.1 Quick Steps

Getting started with XC7 - your new Link IO accessory - is straightforward. The first step is to access its web interface. Follow these steps:

- **Connect the Link IO Device:** Plug a Cat6 (STP) or better Ethernet cable into your SKAARHOJ Link IO device and ensure it is connected to your local network.
- **Download SKAARHOJ Discovery:** Download the SKAARHOJ Discovery application from www.skaarhoj.com, then launch the application from your Mac or PC on the local network.
- **Connect via USB (if needed):** If the device does not appear automatically in Discovery, connect it directly to your Mac or PC using a USB cable.
- **Set IP Address:** In SKAARHOJ Discovery, switch to the On USB tab. Select your device, click the Change IP Address button, enter a valid IP address, and click Save.
- **Access the Web Interface:** Once your device has a valid IP address, it will appear under the On Network tab with an Open button. Click Open to launch the device's Web UI.

Notice

Screenshots from other Link IO Accessories

In this Getting Started section, some screenshots and illustrations may show other products from the Link IO Accessory series. This is because these devices share the same web interface and follow the same procedure for initial setup as the XC7.

While the appearance of the screenshots may differ slightly depending on the specific accessory, the steps and configuration principles are identical. Additional device-specific tabs (such as Raw Panel, TSL, HTTP, etc.) are covered in subsequent chapters.

4.2 SKAARHOJ Discovery

When you launch the SKAARHOJ Discovery application, it automatically scans your local network for connected SKAARHOJ devices. If DHCP is enabled, the Link IO device will obtain an IP address automatically out of the box, and SKAARHOJ Discovery will display it in the device list. In the example below, the Link IO accessory is an ETH-SDI Link. Clicking on the device will display details on the right side of the screen.

You can also click the Open button for the device to launch its web interface, where you can set IP addresses and configure device-specific settings.

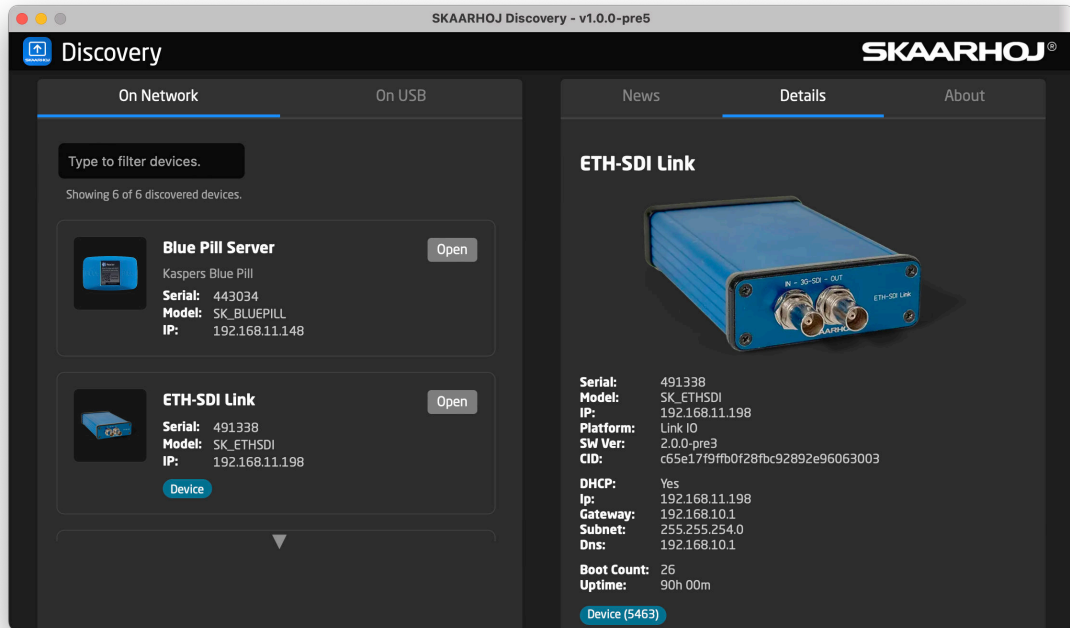

In some cases, your Link IO device may appear in the Network tab but be grayed out, with no Open button available. This can happen if the device has an invalid IP address (e.g., 0.0.0.0) or an unreachable static IP. In that case, connect the device to your computer via Micro USB and assign a new IP address using the USB connection.

4.3 Configuration via USB

Connect the Link IO device to your computer using a Micro USB cable. Launch the SKAARHOJ Discovery application and switch to the On USB tab. Your device should appear in the list. Select it, then click the Change Network Settings button.

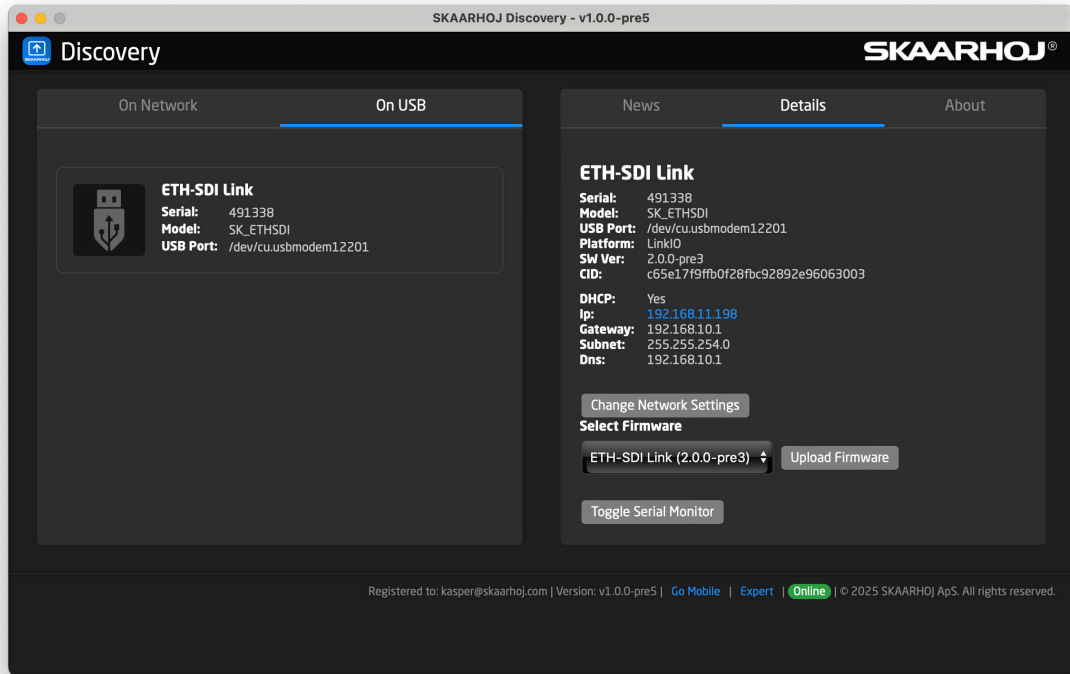

In the fields that appear, enter a static IP address for the device. Make sure to choose an address that is valid for your network and does not conflict with other devices.

The screenshot shows a DHCP configuration dialog box. At the top, there is a "DHCP" label and a toggle switch for "Automatic IP assignment", which is currently turned off. Below this, there are three input fields:

- IP Address:** 192.168.11.198
- Subnet Mask:** 255.255.254.0
- Gateway:** 192.168.10.1

At the bottom of the dialog, there are two buttons: "Update" and "Cancel".

After entering the desired IP address, click the Update button. The new settings will be applied and the device will reboot. Once the update is complete, switch back to the On Network tab to see your device listed with its new IP address.

Caution**Leaving the device connected to USB**

Keeping your XC7 connected to a computer via USB may cause the device to become frozen or non-functional if the computer enters sleep mode while the USB connection is active. The exact behavior can depend on the operating system and other factors. While there are legitimate cases for maintaining an active USB connection, it is recommended to disconnect the USB cable after configuring the device in standard service use.

4.4 Accessing the Web Interface

Once your Link IO device has a valid IP address, it will appear in the On Network tab of the SKAARHOJ Discovery application. Click the Open button next to the device to launch its web interface in your default web browser.

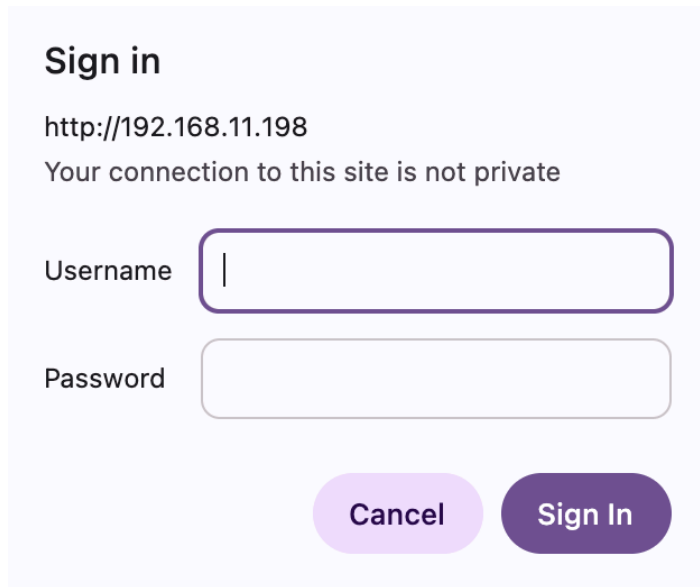

Sign in

http://192.168.11.198

Your connection to this site is not private

Username

Password

You will be prompted to enter a username and password. The default credentials are:

- **Username:** admin
- **Password:** skaarhoj

Caution**Unencrypted Login Credentials**

The username and password are transmitted in **unencrypted form** when accessing the Link IO Web UI:

- **Use only on trusted local networks.**
- **Do not expose the device directly to the internet** without proper network safeguards (e.g., VPN or firewall).
- **Be aware of potential security risks** if used on untrusted or public networks.

After logging in, you will see the main dashboard of the Link IO device. From here, you can configure network settings and other device-specific parameters. Below is an example of the dashboard interface from the Link IO device called ETH-SDI Link.

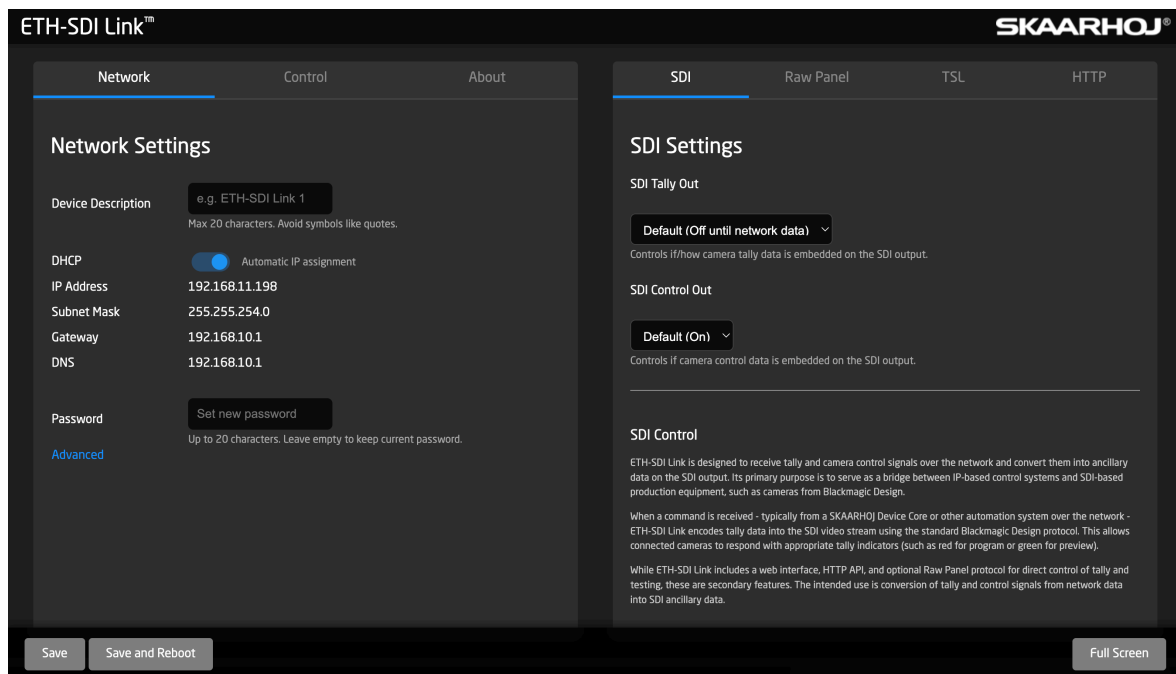

4.4.1 Network Settings

The **Network** tab allows you to configure how your Link IO device connects to your local network. Some of these settings could also be configured via the SKAARHOJ Discovery application over USB. You can assign a static IP address, enable or disable DHCP, and adjust related options for reliable communication.

Network Control About

Network Settings

Device Description
 Max 20 characters. Avoid symbols like quotes.

DHCP Automatic IP assignment

IP Address 192.168.8.102

Subnet Mask 255.255.248.0

Gateway 192.168.10.1

DNS 192.168.10.1

Password
 Up to 20 characters. Leave empty to keep current password.
 Username is always "admin".

Allow access without login Warning: Anyone on the network can access the UI when disabled.

Disable all mDNS advertisements Stops advertising services (Raw Panel, HTTP, etc.) via mDNS.

Enable Ethernet auto-negotiation Let the PHY auto-negotiate speed/duplex (if supported).

Save Save and Reboot

The following options are available:

- **Device Description:** Enter a custom name (up to 20 characters) for your device. This helps you identify it in SKAARHOJ Discovery or other network tools.
- **DHCP (Automatic IP Assignment):** When enabled, the device requests an IP address from your network's DHCP server (e.g., your router). Disable this option to set a fixed static IP address manually.
- **IP Address:** The unique network address of your device. If DHCP is disabled, enter a valid static IP address that matches your network range.
- **Subnet Mask:** Defines the network segment the device belongs to. For most local networks, this will be 255.255.255.0.
- **Gateway:** The IP address of your network's default gateway (typically your router). This setting is required if the device needs to communicate outside of the local subnet.

- **Password:** Allows you to change the device's web interface password (up to 20 characters). Leave this field blank to keep the current password. The username is always "admin". See Advanced settings below for an option to disable password protection entirely.

There are also several advanced options available in the Network Settings tab:

- **Allow access without login:** When enabled, anyone on the network can access and configure the device without entering credentials. **Warning:** This is a security risk and should only be used on trusted, isolated networks.
- **Disable all mDNS Advertisements:** Stops the device from broadcasting its presence on the network via mDNS (Bonjour/ZeroConf). Useful in large installations where reducing network traffic is important.
- **Enable Ethernet Auto-Negotiation:** When enabled, the device automatically negotiates the best possible speed and duplex mode with your network switch. Historically, this has not been enabled in SKAARHOJ devices, but it is now available for compatibility with modern network equipment. This setting can also be changed via USB serial using the command `ethautoneg=1` (enable) or `ethautoneg=0` (disable). A reboot is required for the change to take effect.

Once you have made the necessary changes, click **Save** to apply them, or **Save and Reboot** to restart the device with the new settings.

Notice

Save or Save and Reboot?

When you change settings in the Web UI, you can choose either **Save** or **Save and Reboot**:

- **Save:** Writes the new settings to the device's persistent memory. Some changes take effect immediately without requiring a reboot. This option is faster and suitable for parameters like labels or minor adjustments.
- **Save and Reboot:** Also writes the settings to persistent memory, but additionally restarts the device. A reboot is required for certain changes such as IP configuration, enabling or disabling network services, or changing communication ports. This option ensures that all changes are fully applied, but takes a little longer.

In general, the safe choice is **Save and Reboot**, but it is not necessary for every change you make in the Web UI. Mostly the UI will highlight the button that is recommended for the specific changes you have made.

4.4.2 Managing Configurations

Under the network settings, you can find options for managing device configurations. This allows you to back up your current settings, restore previous configurations, and reset the device to factory defaults.

Configuration

Export your current settings to a file, or import previously saved settings. Factory Reset erases all settings and restores defaults.

[Download config](#) · [Upload config](#) · [Factory Reset](#)

Clicking the link to back up your configuration will download a JSON file containing all current settings. The same file can be uploaded later to restore those settings. Advanced users can also edit the JSON file directly before uploading it back to the device. Restoring to factory defaults erases all custom settings except the network settings and returns the device to its original state.

4.5 Firmware Updates

4.5.1 New Firmware Releases

New firmware releases for the Link IO platform are announced through SKAARHOJ Discovery. When you open SKAARHOJ Discovery, it automatically checks for updates and notifies you if a new firmware version is available for your device. The application will then download the update and prompt you to install it when your device is connected via USB.

The screenshot displays the SKAARHOJ Discovery application interface. The top bar shows the 'Discovery' title and the SKAARHOJ logo. The main content is divided into two sections: 'On Network' and 'On USB'. The 'On USB' section is active, showing a device card for 'ETH-SDI Link' with the following details:

- Serial:** 491338
- Model:** SK_ETHSDI
- USB Port:** /dev/cu.usbmodem12201

To the right, the 'Details' tab is selected, showing more information:

- Serial:** 491338
- Model:** SK_ETHSDI
- USB Port:** /dev/cu.usbmodem12201
- Platform:** LinkIO
- SW Ver:** 1.8.23
- CID:** c65e17f9ffb0f28fbc92892e96063003
- DHCP:** Yes
- Ip:** 192.168.11.115
- Gateway:** 192.168.10.1
- Subnet:** 255.255.254.0
- Dns:** 192.168.10.1

Below the details, there are several interactive elements:

- A 'Change Network Settings' button.
- A 'Select Firmware' section with a dropdown menu showing 'ETH-SDI Link (2.0.0-pre3)' and an 'Upload Firmware' button.
- A yellow notification box stating: 'A newer firmware is available for ETH-SDI Link: 2.0.0-pre3 (you have 1.8.23).'.
- A 'Toggle Serial Monitor' button at the bottom.

To install the update, simply click the Upload Firmware button. The new firmware will be transferred to your device.

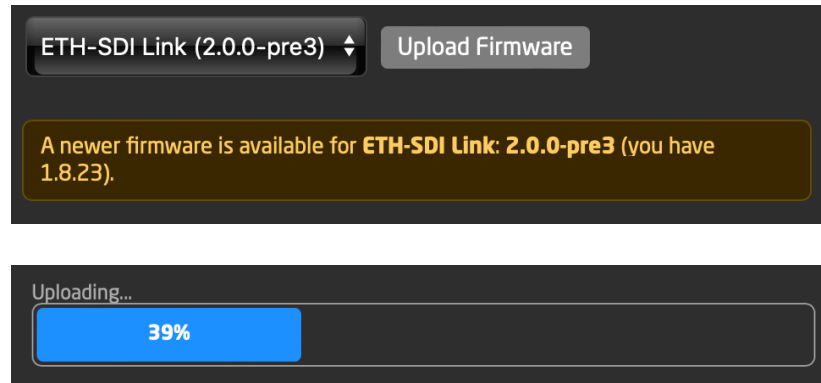

After the update process finishes, the device will reboot automatically. If it does not, you may need to power cycle it by unplugging and reconnecting the device.

Hint

Not Online all the time?

SKAARHOJ Discovery requires an internet connection to download firmware updates. You must therefore be online - at least temporarily - during the update process. For all other interactions with your device, whether over network or USB, an internet connection is not required. If you see a green badge in the footer of the Web UI, it indicates that your computer running SKAARHOJ Discovery is online and connected to the SKAARHOJ servers.

Registered to: kasper@skaarhoj.com | Version: v1.0.0-pre5 | [Go Mobile](#) | [Expert](#) | [Online](#) | © 2025 SKAARHOJ ApS. All rights reserved.

4.5.2 Factory Reset

If you encounter issues with your device, a factory reset may be required. This restores the device to its original settings and erases all custom configurations. A factory reset can be performed in several ways:

- **From SKAARHOJ Discovery:** In the Details tab, click the Factory Reset button. It's shown if settings have become corrupted.
- **Using the Reset Button:** Hold down the Reset button on the device for 10 seconds. This resets all settings to defaults, including network configuration and any custom labels or parameters.
- **Via Serial Monitor:** Open the Serial Monitor in the Details tab of SKAARHOJ Discovery and type the command `_resetA11`. Be sure to close the Serial Monitor after performing the reset.
- **Via Web UI:** Open the web interface of XC7 and go to the **Network** tab. In the Configuration Management section at the bottom of the page, click **Restore Factory Defaults**. This action resets all configurations except the network settings.

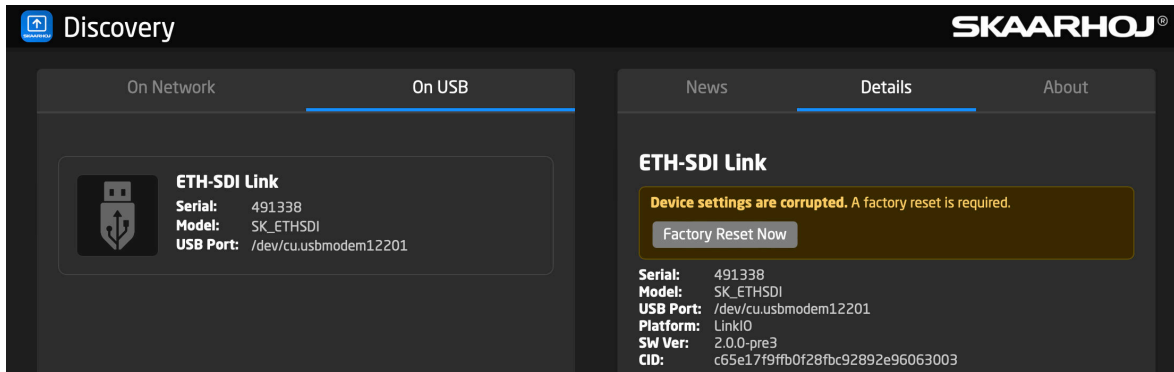

4.5.3 Wrong Firmware

If the wrong firmware has been uploaded to your Link IO device, this will be indicated in SKAARHOJ Discovery.

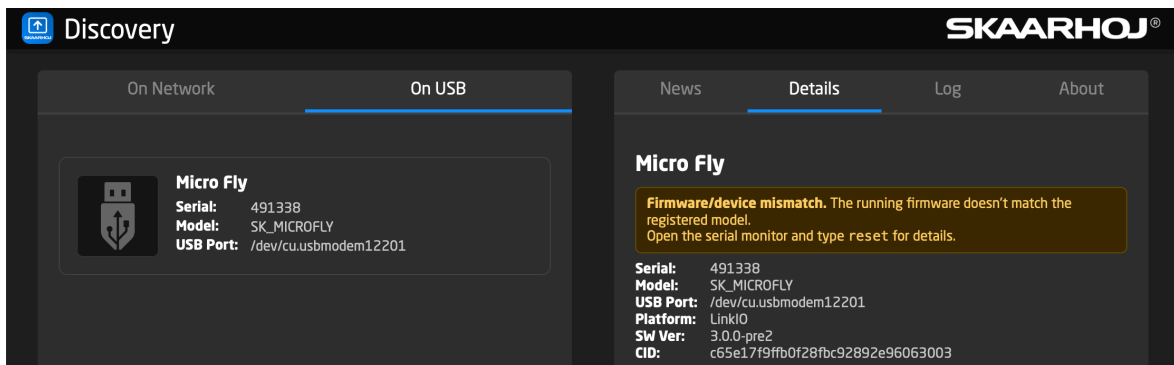

In this case, first enable Expert Mode by clicking the link in the footer. Otherwise you cannot select other firmware types than the one currently installed.

Registered to: kasper@skaarhoj.com | Version: v1.0.0-pre5 | [Go Mobile](#) | [Expert](#) | [Online](#) | © 2025 SKAARHOJ ApS. All rights reserved.

Next, open the Serial Monitor and type `reset`, then press Enter. The device will reboot and display a message indicating the device type it is really registered as. Read the text carefully, as it will tell you which firmware type to select in the next step.

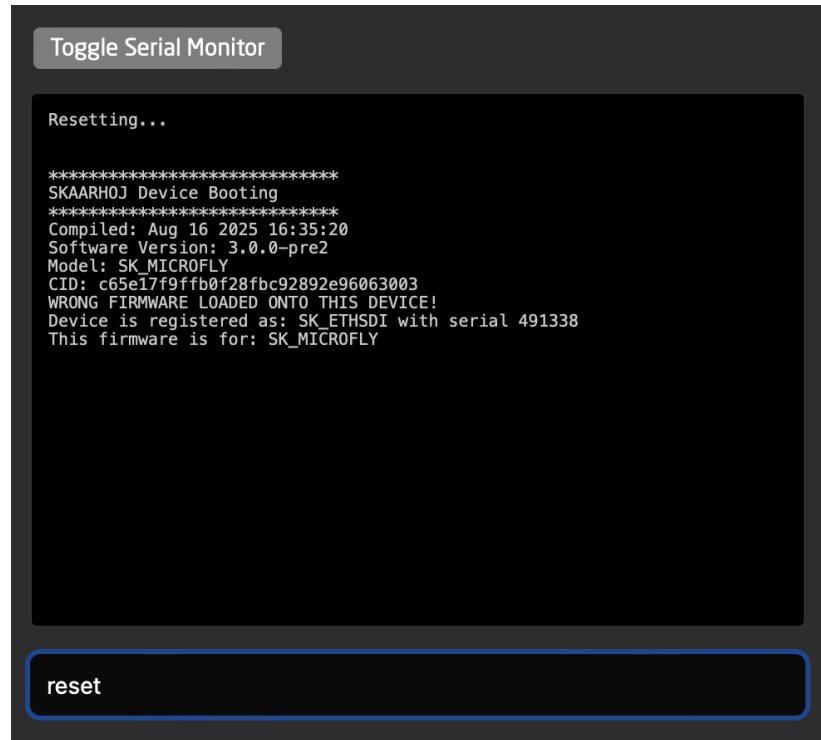

From the list of available firmware in SKAARHOJ Discovery, select the correct firmware for your device and click the Upload Firmware button. The device will reboot and be ready for use with the correct firmware installed.

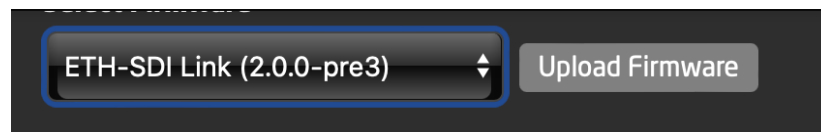

4.5.4 Upgrading to the Link IO Platform

If you wish to upgrade an eligible SKAARHOJ UniSketch or Link IO device to the Link IO platform, follow the steps below. The process requires registering the device on SKAARHOJ's servers, so you must be online during the upgrade. Registration is pending approval by SKAARHOJ and may be free of charge or require a fee, depending on the device and upgrade path.

When you first connect your device, it will appear as Unknown:

The screenshot displays the SKAARHOJ Discovery application interface. The top navigation bar includes a home icon, the word "Discovery", and the SKAARHOJ logo. Below this, there are two main sections: "On Network" and "On USB". The "On USB" section is active, showing a list of devices. One device is listed as "(Unknown)" with a USB icon, and its details are shown below: Serial: -, Model: -, and USB Port: /dev/cu.usbmodem12201. To the right, a "Details" panel for the "(Unknown Device)" provides further information: Serial: -, Model: -, USB Port: /dev/cu.usbmodem12201, Platform: UniSketch, CID: c592d17e233797b7a8afc7b7798a2aa3, DHCP: Yes, IP: -, Gateway: -, Subnet: -, and Dns: -. Below the details, there are buttons for "Change Network Settings", "Toggle Serial Monitor", and a yellow warning box stating "No firmware files match ""; Turn on **Expert Mode** to see all firmware files in case you are initializing a device or know what you are doing." The footer contains registration information: Registered to: kasper@skaarhoj.com | Version: v1.0.0-pre5 | [Go Mobile](#) | [Expert](#) | [Online](#) | © 2025 SKAARHOJ ApS. All rights reserved.

Enable Expert Mode by clicking the link in the footer. This will allow you to select any Link IO firmware type.

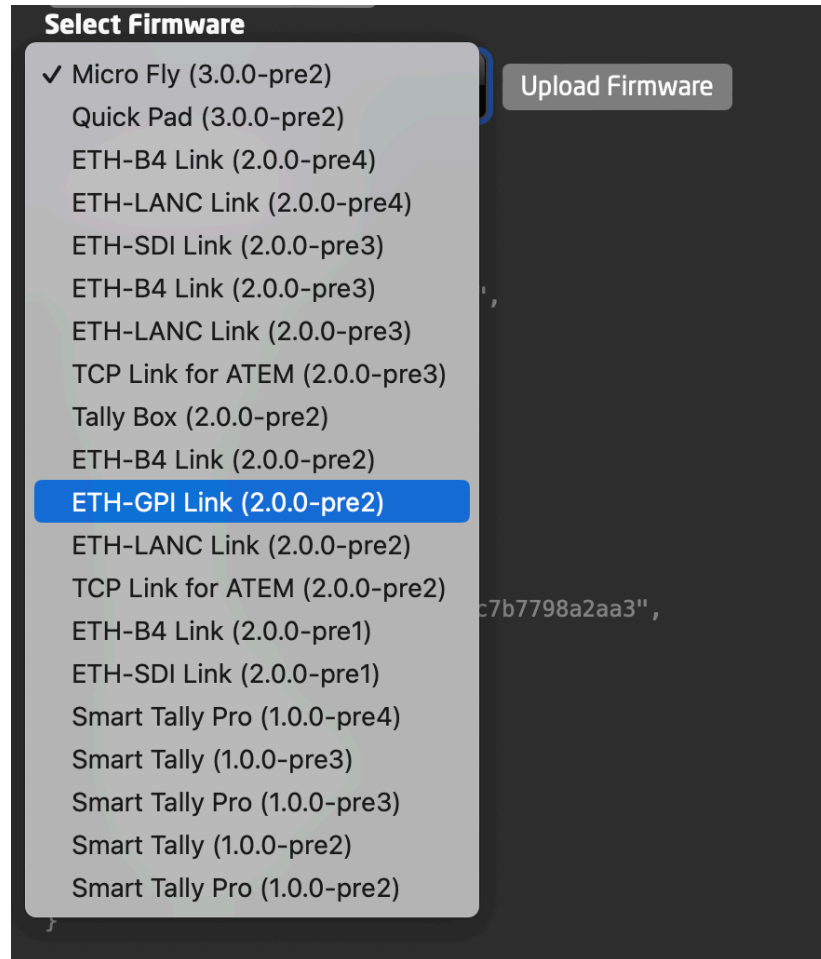

Carefully select the correct firmware type for your device. If you are unsure, contact SKAARHOJ Support for assistance. When you are ready, click the Upload Firmware button.

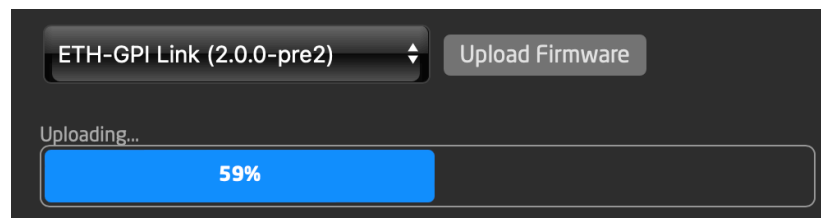

The device will reboot and display a message indicating that it is pending registration. Read the message carefully, and if you agree with its contents, enter the device's serial number and click the Register button.

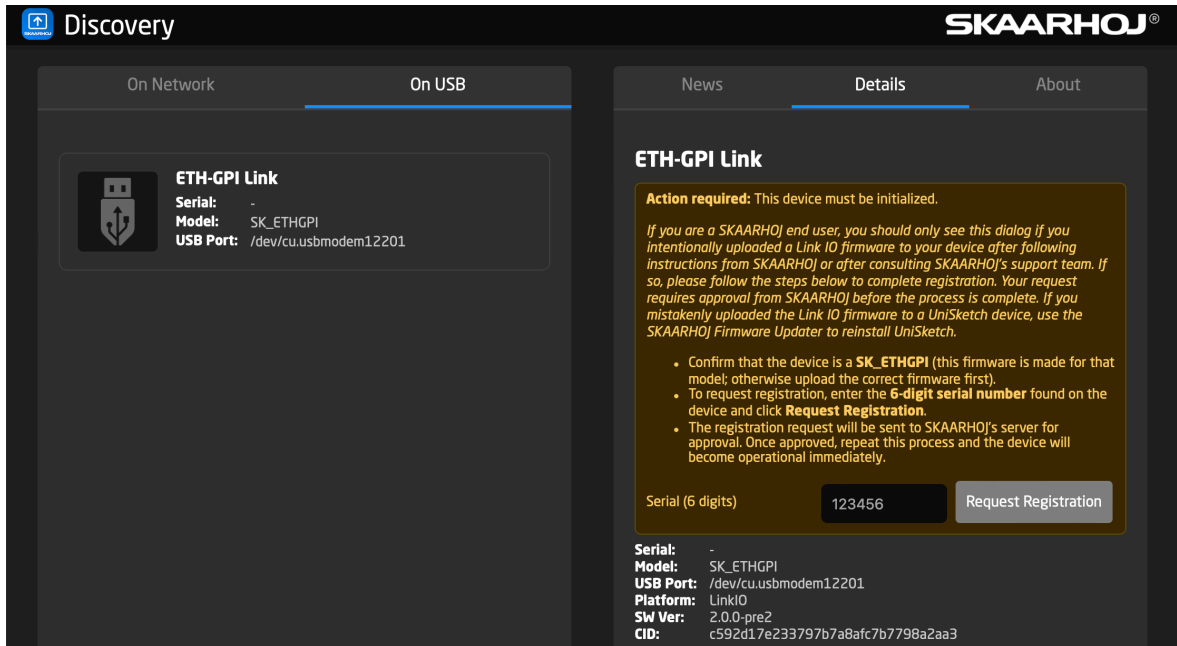

You will then see a confirmation that the device is pending registration. This step must be coordinated with SKAARHOJ Support, so please contact them to complete the approval process.

Registration pending: Registration request received and pending approval.

Once the device has been approved, return to the Web UI, enter the serial number again, and click the Register button. The device will then be fully registered and ready for use with the Link IO platform.

Registration approved: Registration approved.

The device will reboot and may appear as Unknown for a short time:

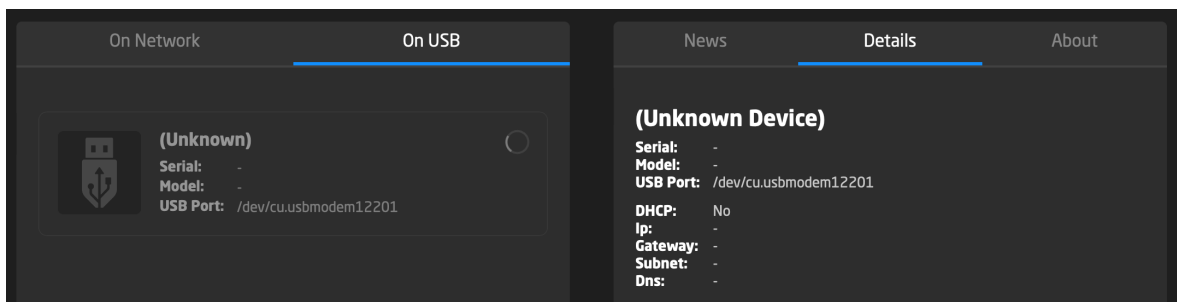

It will then update and show up as the correct device type:

The screenshot displays the SKAARHOJ Discovery application interface. The top navigation bar includes 'Discovery' and the SKAARHOJ logo. Below this, there are two main sections: 'On Network' and 'On USB'. The 'On USB' section is active, showing a list of discovered devices. One device, 'ETH-GPI Link', is selected, and its details are shown in a 'Details' panel on the right. The details panel includes fields for Serial, Model, USB Port, Platform, SW Ver, CID, DHCP, Ip, Gateway, Subnet, and Dns. Below the details, there are buttons for 'Change Network Settings', 'Select Firmware', 'Upload Firmware', and 'Toggle Serial Monitor'. The 'Select Firmware' dropdown is set to 'ETH-GPI Link (2.0.0-pre2)'. At the bottom of the interface, there is a footer with registration information and a copyright notice.

Discovery SKAARHOJ®

On Network On USB News Details About

ETH-GPI Link
 Serial: 442305
 Model: SK_ETHGPI
 USB Port: /dev/cu.usbmodem12201

ETH-GPI Link
 Serial: 442305
 Model: SK_ETHGPI
 USB Port: /dev/cu.usbmodem12201
 Platform: LinkIO
 SW Ver: 2.0.0-pre2
 CID: c592d17e233797b7a8afc7b7798a2aa3
 DHCP: Yes
 Ip: 192.168.11.175
 Gateway: 192.168.10.1
 Subnet: 255.255.254.0
 Dns: 192.168.10.1

Change Network Settings
 Select Firmware
 ETH-GPI Link (2.0.0-pre2) Upload Firmware
 Toggle Serial Monitor

Registered to: kasper@skaarhoj.com | Version: v1.0.0-pre5 | Go Mobile | Expert | Online | © 2025 SKAARHOJ ApS. All rights reserved.

Hint

Internet Connection Required

The upgrade and registration process requires an active internet connection:

- **Stay online during registration:** Your computer must connect to SKAARHOJ's servers to complete the registration and approval process.
- **Approval is handled remotely:** Registration will remain pending until SKAARHOJ Support approves the request.
- **Offline use afterwards:** Once the upgrade and registration are complete, the device can be used fully offline on your local network.

Make sure you are connected to the internet until the registration process has been successfully completed.

4.6 Serial Monitor

The Serial Monitor in SKAARHOJ Discovery allows you to send and receive plain text commands over the USB serial connection. This is useful for debugging or advanced use cases.

You can open the Serial Monitor by selecting your device in the On USB tab and clicking the Toggle Serial Monitor button. You will see an interface similar to the example below:

Toggle Serial Monitor

```

.Continuosly connecting to ATEM switcher on IP 1.2.3.4
[ConnATEM] Connecting to 1.2.3.4
2539
.Attempting TCP link to 9.8.7.6:9923 ... failed.
2088
.Continuosly connecting to ATEM switcher on IP 1.2.3.4
[ConnATEM] Connecting to 1.2.3.4
2532
.2451
.Continuosly connecting to ATEM switcher on IP 1.2.3.4
[ConnATEM] Connecting to 1.2.3.4
.Attempting TCP link to 9.8.7.6:9923 ... failed.
2092
.2561
.Continuosly connecting to ATEM switcher on IP 1.2.3.4
[ConnATEM] Connecting to 1.2.3.4
2330
.Attempting TCP link to 9.8.7.6:9923 ... failed.
1927
.Continuosly connecting to ATEM switcher on IP 1.2.3.4
[ConnATEM] Connecting to 1.2.3.4
2483
.2476
.Continuosly connecting to ATEM switcher on IP 1.2.3.4
[ConnATEM] Connecting to 1.2.3.4
.Attempting TCP link to 9.8.7.6:9923 ... failed.
2132
.

```

| Type message and press Enter

To view the list of available commands, type “help” and press Enter in the message field below the monitor output window. The supported commands will be displayed. You can type any supported command in the message field and press Enter to send it to the device. The device’s response will appear in the output window.

help	Show this help message
ip=a.b.c.d	Set static IP or use ip=0.0.0.0 for DHCP
subnet=a.b.c.d	Set subnet mask
gateway=a.b.c.d	Set gateway address
dns=a.b.c.d	Set DNS server
reset	Reset the device (soft reset)
reboot	Alias for reset
notick	Disable dot and loopcount output every second
ping	Returns ack
debug	Enable debug mode until reboot
sockets	Show current socket status
newmac	Generate and save a new MAC address
_resetAll	Clear user settings and reset
getCID	Get the device CID
getInfo	Display detailed device status in JSON format

<code>ip=?</code>	Get the current IP address in use
<code>dumpIP</code>	Display IP configuration

4.7 Raw Panel over USB Serial

For Link IO devices that support Raw Panel functionality, you can also use the Serial Monitor to send and receive Raw Panel commands over USB. To enable this mode, type the command `serialRawPanel` in the message field and press Enter. The device will switch to Raw Panel mode on the USB connection, allowing you to send and receive Raw Panel commands directly. The only way to exit this mode is to reboot the device by power cycling it. Using USB for Raw Panel commands disables all other serial communication.

Using the Raw Panel protocol over the USB connection of XC7 is a highly advanced feature intended for integration by programmers. Typically, developers would write a custom application on the host system that opens the USB port at 115,200 bps, sends the command `serialRawPanel\n`, and then issues Raw Panel commands such as `list\n`.

5 XC7 Functionality

The **XC7** is a compact IP-enabled controller built for direct integration with SKAARHOJ systems via the Raw Panel Protocol. A dedicated Joystick tab lets you fine-tune the built-in joystick sensor so motion feels smooth, precise and free of drift. The web interface follows the familiar tabbed layout used across SKAARHOJ devices and covers two areas: **Raw Panel** and **Joystick**. A basic **Network** page is also provided for IP addressing and housekeeping.

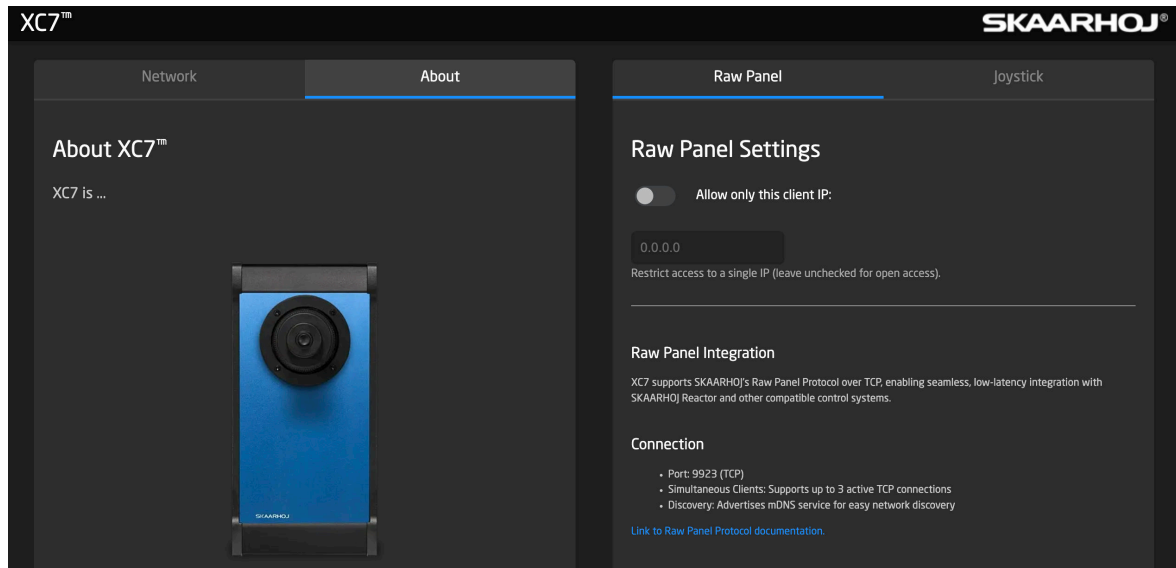

5.1 Network Tab

Use the **Network** tab to assign the device identity and IP parameters.

- **Device Description:** Free text label (max 20 characters) for identification on your network and in Reactor.
- **DHCP:** Toggle automatic addressing. When disabled, enter IP Address, Subnet Mask and Gateway manually.
- **Password:** Set a new web UI password (leave empty to keep the current one).
- **Advanced:** Expert options to disable mDNS advertisements, enable Ethernet auto-negotiation and optionally disable UI authentication (not recommended on shared networks).

5.2 Raw Panel Tab

XC7 communicates with SKAARHOJ Reactor and other control systems using the **Raw Panel Protocol** over TCP.

- **Allow only this client IP:** Optional whitelist that locks access to a single IP; leave disabled for open access on the LAN.

Connection Details

- Port: 9923 (TCP)
- Simultaneous clients: up to 3
- Discovery: mDNS service broadcast

Hint

Integration tip

Add XC7 to Reactor as a Raw Panel device and map its controls to your router, switcher or cameras and sliders. XC7 also works with various default configurations for out-of-the box applications.

5.3 Joystick Tab

On XC7, the **Joystick** tab provides four tuning parameters. These settings are applied in hardware, so downstream systems receive clean, normalized values.

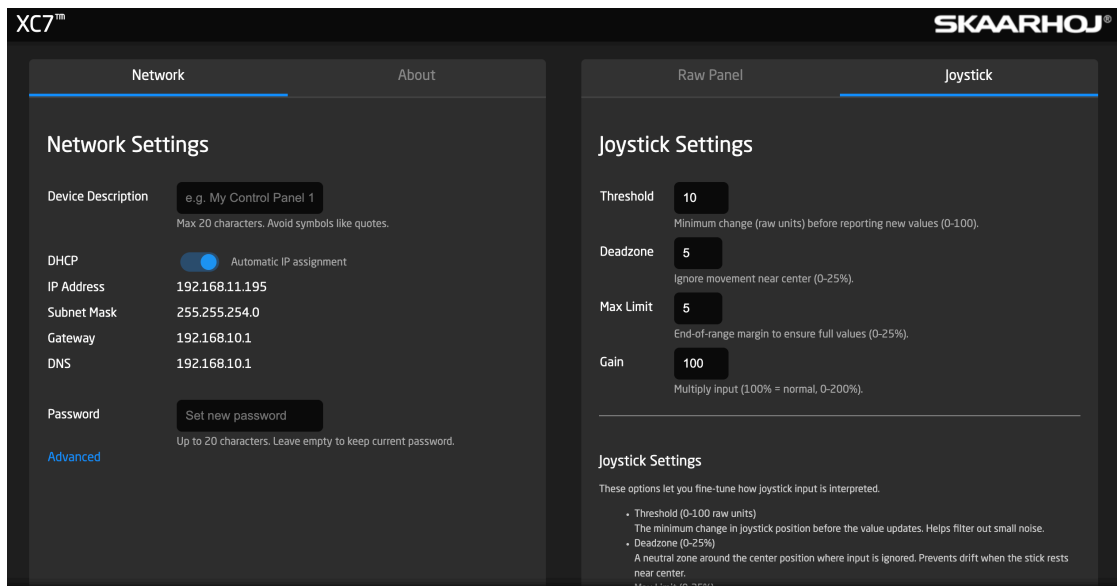

Parameters

- **Threshold (0–100 raw units)**
Sets the minimum change required before a new joystick value is reported. Use higher values to filter tiny jitters; lower values for maximum sensitivity.

- **Deadzone (0–25%)**
Defines a neutral area around the mechanical center where movement is ignored. This prevents drift when the stick rests near center.
- **Max Limit (0–25%)**
Adds a short end-stop margin so the joystick always reaches full-scale values even if the physical travel or calibration is slightly short.
- **Gain (0–200%)**
Output multiplier applied after the other adjustments. 100% equals unity gain; increase to make responses snappier or decrease for finer control.

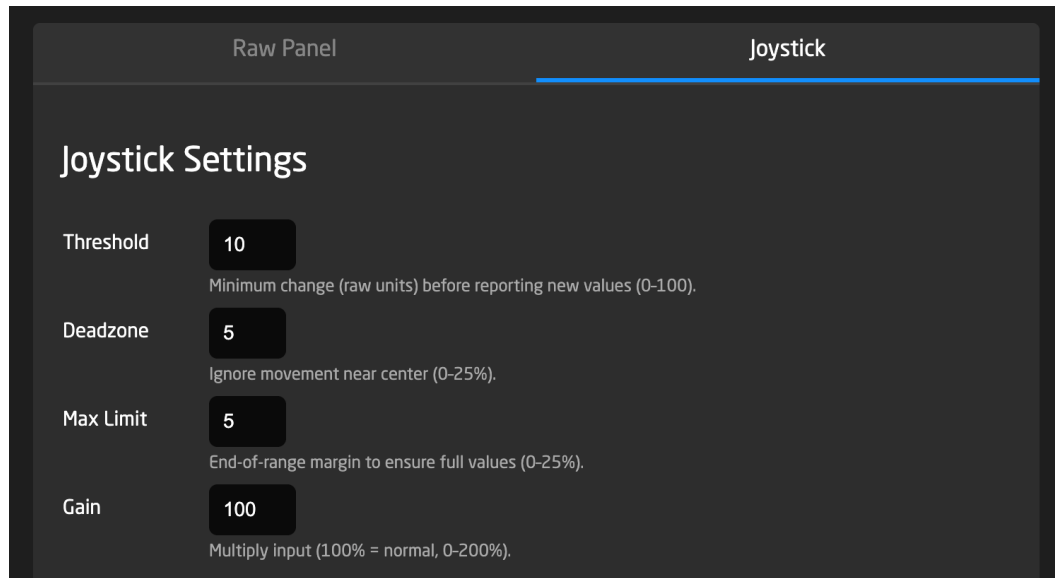

Notice

Recommended starting point

Threshold: **10**, Deadzone: **5%**, Max Limit: **5%**, Gain: **100%**.

Increase Threshold slightly in noisy environments; reduce Gain if you want higher sensitivity and don't need the full movement speed at the extreme positions.

6 Service

6.1 Troubleshooting

For troubleshooting tips, please refer to our online Wiki:

<https://wiki.skaarhoj.com/books/blue-pill-reactor/chapter/troubleshooting>

6.2 Cleaning

Proper cleaning and maintenance of your XC7 are critical to ensuring its durability and optimal performance. Regular cleaning, when done with care and the right materials, will help maintain the device in excellent working condition. On the other hand, improper cleaning techniques or the use of harsh chemicals can lead to permanent damage to surfaces, connectors, and labels. To prevent wear and tear, it is important to adhere to the cleaning recommendations outlined in this section.

Notice

Proper Cleaning of XC7

To avoid surface damage, follow these guidelines:

- **Disconnect all accessories and cables** before cleaning.
- **Only use the recommended cleaning agents** listed in this section.
- **Avoid harsh chemicals** like Methanol, Acetone, Benzine, or acids. These substances may damage labels, paint, and polished surfaces.
- **Keep connectors dry**—do not moisten connectors or expose them to cleaning liquids.
- **Avoid touching connector pins** directly while cleaning.
- **Air-blow dust from connectors** before wiping them. Use deionized air if static charge is present.
- **Do not use compressed air** on the housing, as it can push dust into the device.

Recommended Cleaning Agents:

- Water
- Glass Cleaner
- Isopropyl Alcohol

To maintain the longevity and optimal performance of your XC7, it is essential to follow proper cleaning guidelines. Different areas of the device require specific cleaning methods to avoid damage to sensitive components. The following table outlines the recommended cleaning procedures for key areas of the device.

Area	Recommended Cleaning Procedure
Housing	Wipe the housing and external accessories with a soft, lint-free cloth and a mild cleaner like water or glass cleaner. When necessary, use isopropyl alcohol to remove tough residues, such as adhesive or dirt buildup.
Narrow spaces and gaps	Use a manual air blower or a soft brush to gently remove dust from gaps and tight spaces. For delicate areas, cotton swabs may also be used.

Table 2: Proper cleaning methods for XC7

By following these cleaning instructions, you can avoid damaging your device and its components. Routine maintenance will keep your XC7 in top condition and reduce the likelihood of damage that could lead to costly repairs or replacements.

6.3 Repair

In addition to proper cleaning, it is also important to be cautious when it comes to repairs. Performing repairs without the necessary expertise can result in personal injury and may further damage the device.

Warning

Repairs by Untrained Personnel

Attempting to repair the device without proper training can lead to injury and product damage:

- **Only perform maintenance tasks** described in this manual.
- **Do not attempt repairs yourself** —all repairs must be carried out by authorized SKAARHOJ service partners.
- **Warranty is void** if unauthorized repairs are attempted.

Repairs and maintenance should always be conducted by professionals trained to handle the XC7. If you encounter any issues requiring repair, we highly recommend contacting SKAARHOJ's authorized service partners. Unauthorized repairs may void the warranty, cause further damage, and pose significant safety risks.

To keep your XC7 functioning optimally, always refer to this manual for proper cleaning and repair procedures. For any work beyond the scope of this manual, please contact SKAARHOJ Support team for assistance.

6.4 Disposal

Notice

Disposal of the Product

You can return the product at your own expense to the manufacturer, SKAARHOJ ApS, for disposal. Always follow local guidelines and laws for proper disposal.

Proper disposal of electronic equipment is essential to reduce environmental impact and ensure that hazardous materials are handled safely. Different countries may have specific laws and guidelines regarding electronic waste disposal. It is important to familiarize yourself with these rules to ensure compliance and minimize risks to both health and the environment.

When disposing of third-party accessories, always consult the instructions provided by the relevant manufacturers to ensure safe and compliant disposal practices.



This product falls within the scope of Directive 2012/19 / EU OF THE EUROPEAN PARLIAMENT AND OF THE COUNCIL of June 4, 2012 on waste electrical and electronic equipment (WEEE II).

Accordingly, this product must not be disposed of with household waste. Always adhere to country-specific disposal rules and ensure proper recycling or disposal through authorized facilities.

In addition to the general guidelines provided above, the product must always be disposed of in accordance with local electronic waste regulations. The WEEE Directive sets the framework for the handling of waste electrical and electronic equipment across EU member states. It ensures that electronics are collected and treated separately from household waste to minimize environmental harm.

6.5 Transportation and Storage

Notice

Proper Handling of XC7

To avoid the risk of product damage:

- Follow the recommended environmental conditions at all times.
- Use an appropriate case for transporting the product and its accessories.
- Adhere to the transport and storage guidelines outlined in this section.

Ensuring proper transportation and storage of your XC7 is critical to maintaining its performance and longevity. Mishandling the device or its accessories can lead to damage. Please follow these guidelines to protect your equipment during transportation and storage.

Transportation Guidelines:

- Detach all accessories from the product before transport.
- Always transport the product in a protective case designed for its dimensions.
- Avoid exposing the product to strong shocks or impacts during transport.
- Keep the product within the recommended temperature range.

Storage Guidelines:

- Remove all accessories before storing.
- Disconnect all cables and power sources from the product.
- Store the product in a protective case.
- Keep the product within the recommended temperature range.
- Avoid storing the product in environments exposed to extreme temperatures, direct sunlight, high humidity, excessive vibration, dust, or strong magnetic fields.

6.6 SKAARHOJ Service Contacts

For any inquiries, technical support, or service requests regarding your XC7, please reach out to our support team. Our dedicated professionals are ready to assist you with troubleshooting, repairs, and general product information. You can find the contact details for SKAARHOJ below.

SKAARHOJ ApS

Rosenkaeret 11C
DK-2860 Soeborg
Denmark
Email: support@skaarhoj.com
Website: www.skaarhoj.com

SKAARHOJ Inc

2600 W Olive Avenue Suite 500
Burbank, CA 91505
USA
Email: support@skaarhoj.com
Website: www.skaarhoj.com

7 Notes
