

SEKONIC

Transmitter

RT-20PW

RT-3PW

Operating Manual

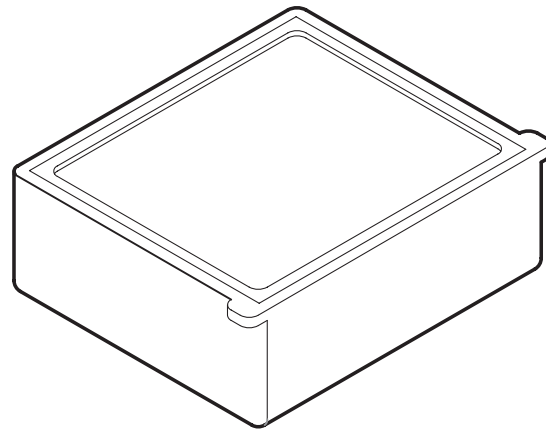





PocketWizard[®]

This manual is specific for PocketWizard[®] operation.
Please read this operating manual and safety precaution so that you will fully understand the features and operation of this product.
Keep the operating manual in a safe place for future use.

■ Safety Precautions

Before using this product, please read this "Safety Precautions" for proper operation.

 WARNING	The WARNING symbol indicates the possibility of death or serious injury if the product is not used properly.
 CAUTION	The CAUTION symbol indicates the possibility of minor to moderate personal injury or product damage if the product is not used properly.
 NOTICE	The NOTICE symbol indicates cautions or restrictions when using the product. Please read all notes to avoid errors in operation.
 NOTE	The reference symbol indicates additional information about the controls or related functions. Reading these is recommended.
	The arrow indicates reference pages.

WARNING

Keep the materials used in this product out of the reach of children to prevent accidental ingestion and misuse.

CAUTION

To avoid damage from static electricity, remove the static electricity from your body by touching metals located nearby (e.g. door knob, aluminum sash) before touching the radio transmitting module.

■ Terms and Trademarks

PocketWizard[®] and ControlTL[®] are the registered trademarks of LPA Design.

NOTICE

- Reproduction of all or any part of this document without permission is strictly forbidden.
- The product concerned and/or this manual may be subject to changes for the product's specification modifications and other reasons without prior notification.
- The screens in this manual may differ from the actual displays of the meter you are using. (Colors, letters, etc.)

©2017 SEKONIC CORPORATION All Rights Reserved.

■ List of Applicable Model

This transmitter is an accessory dedicated to the following model (light meter).

Model		
Transmitter Model	Manufacturer/Frequency	L-858D Series Serial No.
RT-20PW	PocketWizard (FCC & Canada IC): 344.0 to 354.00 MHz	JY11-XXXXXX(Canada IC) JY1L- XXXXXX(FCC)
RT-3PW	PocketWizard (CE & NCC): 433.42 to 434.42 MHz	JY11-XXXXXX(CE) JY1G- XXXXXX(NCC)

■ Intended Use

This product can be used in the following situations.

- Radio wave-based flash light triggering or output power control.
- Radio wave-based modeling lamp ON/OFF.

■ Intended Users

The intended users of this product are those who are engaged in shooting or related businesses, such as photographers, who use the flash units.



■ Features of the RT-20PW and RT-3PW

To use the Radio Triggering Mode of the L-858D after the transmitter is installed, the flash unit must be equipped with a radio function supported by a specified manufacturer, or a receiver supporting the radio function must be connected to the flash unit.

Using the Radio Triggering Mode, firing a flash or adjusting the output power by yourself can be easily accomplished.

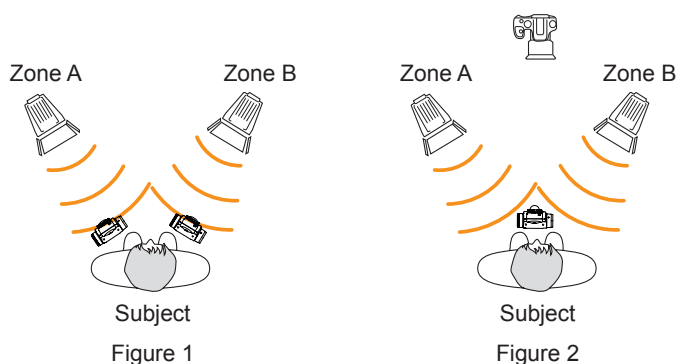
- Take measurements by placing the meter at the subject position with the light receptor (retracted lumisphere) facing toward the light sources of main light and fill light directly. Adjust the measured values for the desired lighting ratio.
- Turn on all light sources to measure the final exposure, and point the lumisphere (extended lumisphere) at the camera from the position of subject. (►P13)



	Light meter (with the transmitter installed)
	Light source (with a receiver built-in/installed)
	Camera

Note that a transmitter of RT-20PW or RT-3PW can support two types of radio system. The user can select which radio system to use in the custom setting of the L-858D light meter.

For details on each radio system, refer to the descriptions in the relevant pages.

Regulation	Radio System	Radio CH/Zone	Function
RT-20PW FCC & Canada IC	Standard	CH1 to 32	Flash light triggering
		Zone: A to D	
	ControlTL	CH1 ~ 20	Flash light output power control and modeling lamp ON/OFF
		Zone: A to C	
RT-3PW CE & NCC	Standard	CH1 to 32	Flash light triggering
		Zone: A to D	
	ControlTL	CH1 to 3	Flash light output power control and modeling lamp ON/OFF
		Zone: A to C	

Restrictions

There are some cautions and restrictions regarding the use of this product. Please read and understand the following before using the meter.



NOTE

- The operation of this product may change without prior notice due to specification changes or other reasons. Therefore, the contents of this operating manual may differ from actual operation of the product.
URL: www.sekonic.com/support/instructionmanualuserguidedownload.aspx
- The safety-related precautions such as "Safety Guide and Maintenance" and "Safety Precautions" conform to the legal and industry standards that were applicable at the time this operating manual was created. Therefore, this manual may not contain the latest information. If you are using the previous operating manual, please download and refer to the latest operating manual.
- The product may contain printing materials such as cautions related to safety and/or printing errors as a supplement to the operating manual.
- The contents of this operating manual may be reproduced for non-commercial purposes and for personal use only. However, the reproduced material must contain the copyright notice of our company.
However, such copies must have our copyright notice as a condition.
- The screens in this operating manual may differ from the actual displays of the meter you are using. (Colors, letters, etc.)

Accompanying Accessories

The following items are included with the Transmitter RT-20PW or RT-3PW. After opening the package. Please be sure to check that all noted items are included. If any items are missing, please contact the distributor or the reseller you purchased the transmitter from.

Transmitter

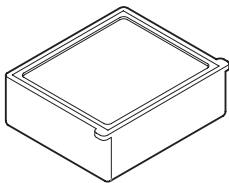

Startup Guide

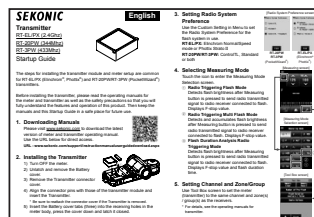

Table of Contents

■ Safety Precautions	i
■ Terms and Trademarks	i
■ List of Applicable Model	ii
■ Intended Use	ii
■ Intended Users	ii
■ Features of the RT-20PW and RT-3PW	iii
■ Restrictions	iv
■ Accompanying Accessories	iv
1. Before Use	1
1-1 Installing the Transmitter	1
2. PocketWizard Wireless Technology	2
2-1 Overview	2
2-2 Setting the Radio System	4
2-3 Setting the Radio CH/Zone	6
2-4 Measuring	9
2-4-1 Radio Triggering Flash Mode	9
1) How to Use Flash Triggering	9
2) How to Use Flash Power Control	12
2-4-2 Radio Triggering Multi (Cumulative) Flash Mode	14
1) How to Use Flash Triggering	14
2) Multi Clear	16
2-4-3 Flash Duration Analysis Radio Triggering Mode	17
1) How to Use Radio Triggering	17
2) How to Use Flash Power Control	21
3) Flash Duration Analysis t Value	24
3. Product Information	26
4. Regulation	28
5. Radio Channel Frequencies	29
6. Legal Requirements	30
7. Troubleshooting	31

1. Before Use

1-1 Installing the Transmitter

CAUTION

To avoid damage from static electricity, remove the static electricity from your body by touching metal objects located nearby (e.g. door knob, aluminum sash) before touching the radio transmitting module.

The numbering below refers to the L-858D Operating Manual.

1. Turn OFF the meter.
2. Unlatch **15** and remove the Battery Cover **14**.
3. Remove the Transmitter Connector Cover **19**.
4. Align the connector pins with those of the Transmitter Module Compartment **18** and insert the Transmitter.

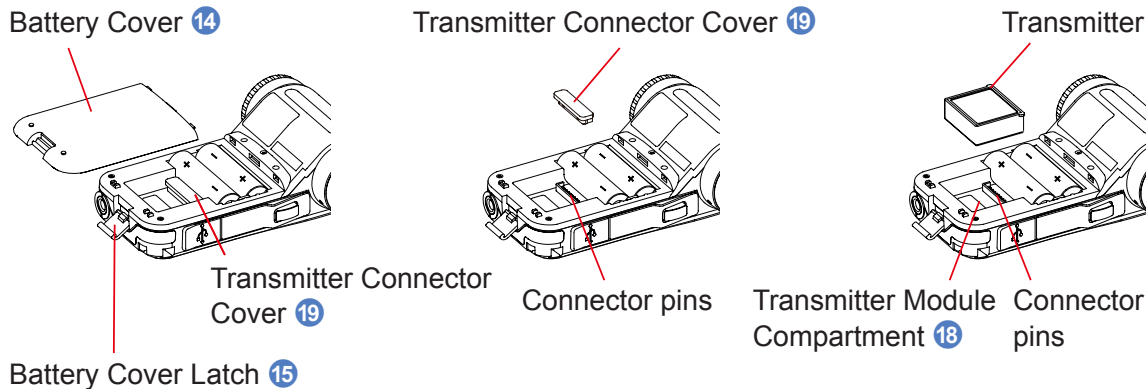

5. Insert the Battery Cover **14** tabs (three) into the receiving holes in the meter body, press the Battery Cover **14** down and close the Battery Cover Latch **15**.

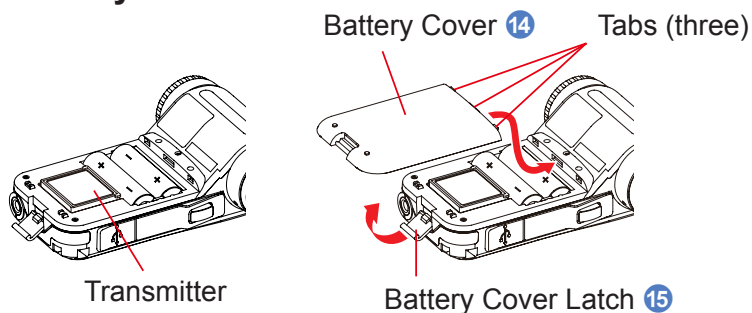

2. PocketWizard Wireless Technology

2-1 Overview

Plug-in external or built-in PocketWizard receivers are required to work with the PocketWizard wireless technology.

Once the transmitter module is installed in your L-858D, you will be able to adjust the power level and trigger flashes to get the look you desire. For more information about the meter, refer to the L-858D Operating Manual.

For more information about PocketWizard, go to www.pocketwizard.com.

<Standard System>

PocketWizard Standard system provides simple triggering and do not allow power control. The Standard system features 32 channels: Channels 1-16 fire single trigger signals; Channels 17-32 have four zones (A, B, C, D) which enable triggering four separate flashes on each channel.

<ControlTL System>

When used with ControlTL receivers, the L-858D is capable of controlling the power level of the compatible flashes connected.

The ControlTL system features 20 channels for FCC&IC version or 3 channels for CE version, and three zones (A, B, C) allowing control of three separate flashes on each channel.

<Radio Frequency>

To comply with local broadcast regulations, Sekonic wireless systems sold in the various markets around the world are designed to operate at different frequencies. Sekonic meters have built-in transmitting antennas that are specifically tuned for their market area. When purchasing and/or installing a transmitter module or using the meter with a receiver, be sure that the meter and receiver are designed to be used in your location and use the same frequency.

- USA/North American market frequencies (FCC & Canada IC): 344.0 to 354.0MHz
- European and other market frequencies (CE, NCC or OFCA): 433.42 to 434.42MHz

 **NOTICE**

Successful radio triggering depends on several factors. Please read these setup steps before using the L-858D to radio trigger flash units.

1. It is the best to position the meter in sight of the radio receiver (or flash head).
 2. Position the radio receiver so that it is away from large metallic objects, concrete, or containers of water (like people).
 3. Secure the radio receiver to the flash using hook-and-loop-type attachment tape or the threaded socket on the radio. Make sure the radio's antenna is above the flash body or generator pack. Do not allow the receiver antenna to contact metal objects.
 4. Sometimes, conditions do not allow radio reception. These could include strong local radio interference or being near objects that block or absorb the signal. Repositioning the radio, even slightly, can reestablish contact. Alternatively, check to see if the radio receiver is behind objects that absorb or block radio waves, such as concrete, metal or low hill.
 5. Operation is the best when the meter to receiver distance is within 30 meter (100 feet).
-

2-2 Setting the Radio System

In the Radio System Preference Screen, select Standard or ControlTL according to the setting on the PocketWizard receiver.

Operation

1. Press the Menu Button ⑨ on the meter.

The Menu Screen is displayed.

2. Touch [Custom Setting] Button.

The Custom Setting Menu Screen is displayed.

3. Touch the [Next Page] Icon (▼) of the Custom Setting Menu Screen to display the [Radio System Preference] on Page 3.

4. Touch [Radio System Preference] Button.

The Radio System Preference Screen is displayed.

5. Touch the system to use.

Touch the desired radio button or an area around the item name to select the [ControlTL], [Standard] or both.

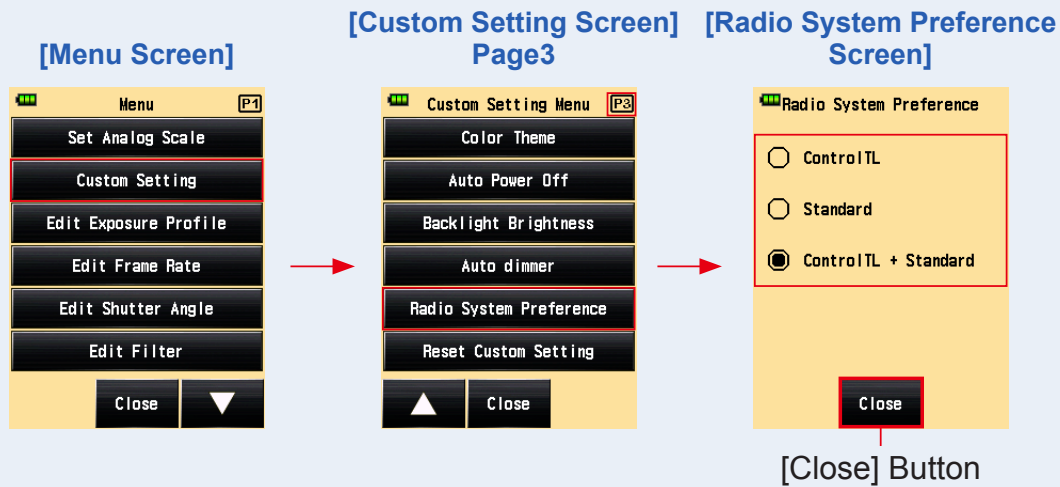
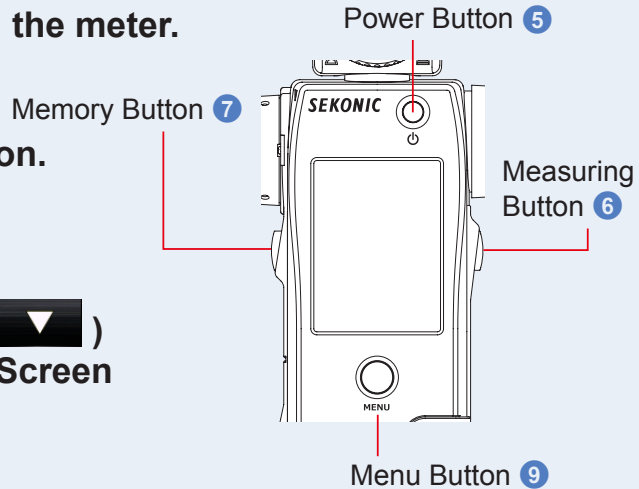

6. Touch the [Close] Button.

The display returns to the Custom Setting Menu Screen.

7. Touch the [Close] Button on the Custom Setting Menu Screen.

The display returns to the Menu Screen.

8. Touch the [Close] Button on the Menu Screen.

The display returns to the Measuring Screen.

The selected radio system indication along with channel number and zones are displayed on the Measuring Screen.

[Custom Setting Menu Screen]

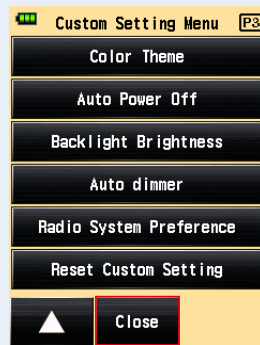

[Close] Button

[Menu Screen]



[Close] Button

[Measuring Screen]

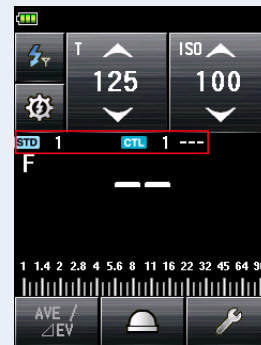

Standard System, Channel (1 to 16)

Standard System, Channel (17 to 32) and Zones (A to D)

ControlTL System, Channel and Zones (A to C)





NOTICE

Set both the meter and plug-in external or built-in PocketWizard receivers to the same system (Standard and/or ControlTL).

2-3 Setting the Radio CH/Zone

Set the radio channel and zones used on Standard System.

Operation

1. Select any Radio Mode in the Measuring Mode Screen.
(⇒ P9 “”, ⇒ P14 “”, ⇒ P17 “”)
2. Touch the [Tool Box] Icon () on the Measuring Screen.
The Tool Box Screen is displayed.
3. Touch the [Next Page] Icon () of the Tool Box to display the Tool Box showing [Radio CH/Zone].
4. Touch [Radio CH/Zone] Button.
The Radio CH/Zone Setting Screen is displayed.

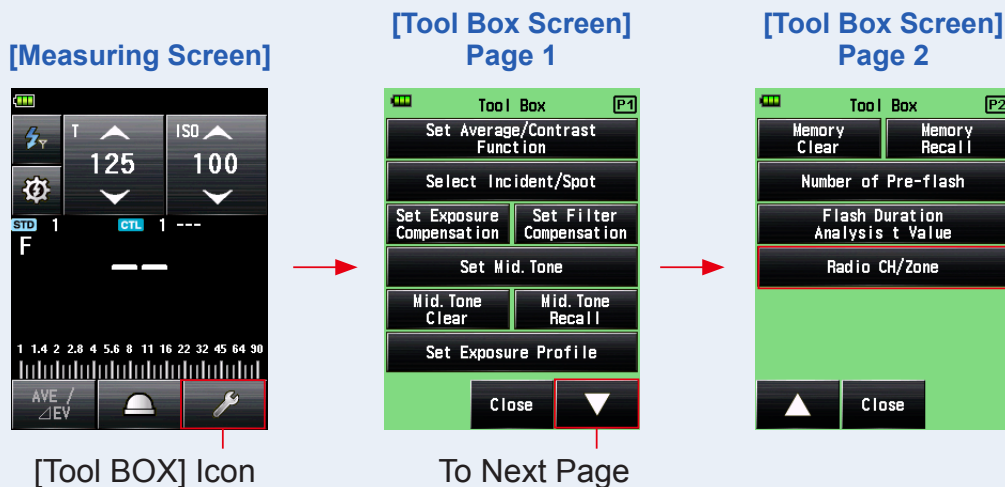

* When the Multiple (Cumulative) Flash Mode is selected, the displayed information are different from those shown above.

5. Touch the [STD] or [CTL] tab to select the radio system.

STD stands for Standard, and CTL stands for ControlTL.

[Radio CH/Zone Setting Screen (Standard)]

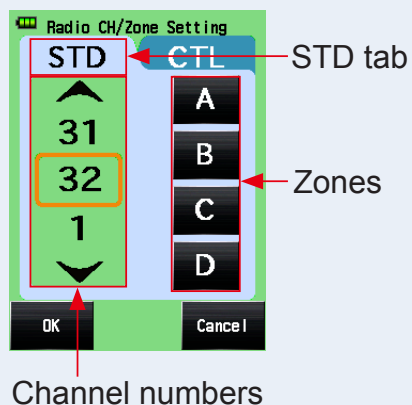

[Radio CH/Zone Setting Screen (ControlTL)]

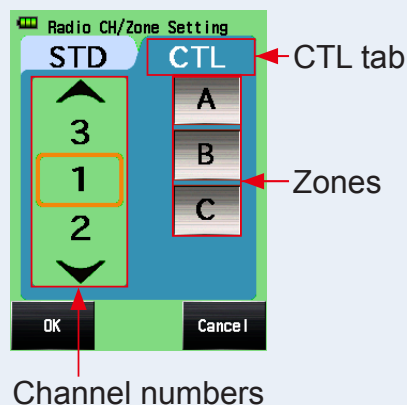

6. Select the channel to use.

Touch the arrows  /  or slide your finger over the screen to select Channel.

Standard: from 1 to 32.

ControlTL: from 1 to 20 (for FCC and Canada IC), from 1 to 3 (for CE and NCC)

7. Select the desired Zones.

Touch the one or more Zones to select the flash units in use.

Standard: from A to D (When the channel number from 17 to 32 is selected, Zones appear.)

ControlTL: from A to C

* Zones to use can be selected from Power Control Screen as well.

8. Touch [OK] Button.

The setting is entered, and the display returns to the Measuring Screen.

Touch the [Cancel] Button to return to the Measuring Screen without making the modification.

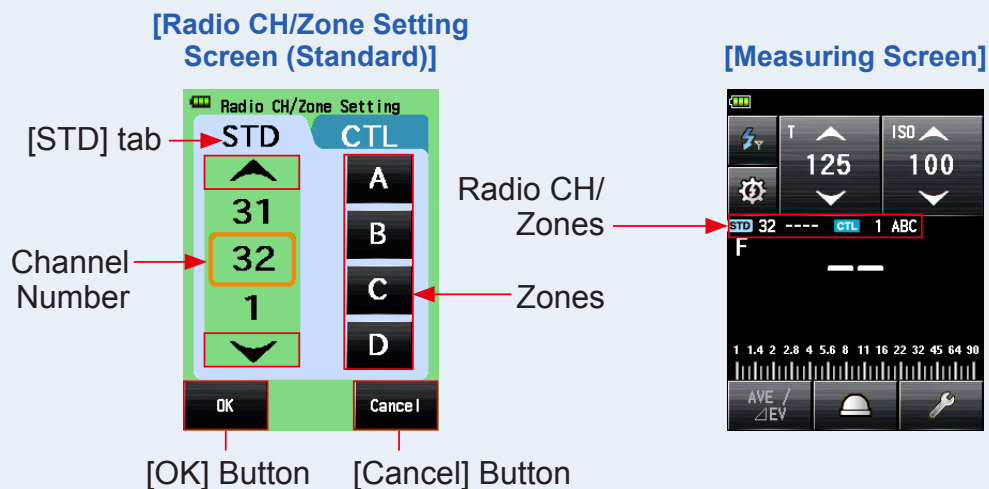

NOTICE

Set both the meter and plug-in external or built-in PocketWizard receivers to the same radio system (Standard or ControlTL).

NOTE

- The last selected Zones in either Power Control Screen or Radio CH/Zone Setting Screen in Tool Box are activated in Measuring Screen.
- For touch/slide operations, refer to the Operating Manual of the light meter.
- For radio CH frequencies, refer to "5. Radio Channel Frequencies". (► P29)

2-4 Measuring

Radio triggering measurement is available in the following modes:

- Radio Triggering Flash Mode
- Radio Triggering Multi (Cumulative) Flash Mode
- Flash Duration Analysis Radio Triggering Mode

2-4-1 Radio Triggering Flash Mode

The meter detects flash brightness after Measuring Button is pressed to send radio transmitted signal to radio receiver connected to flash. F-stop value is displayed for input ISO sensitivity and shutter speed. Depending on the radio system in use, the meter controls the output power of flash units and turns ON/OFF the modeling lamps.

Operation

1) How to Use Flash Triggering

1. Touch the [Measuring Mode] Icon on the Measuring Screen.



The Measuring Mode Screen is displayed.

2. Touch the [Radio Triggering Flash Mode] Icon () in Measuring Mode Screen.

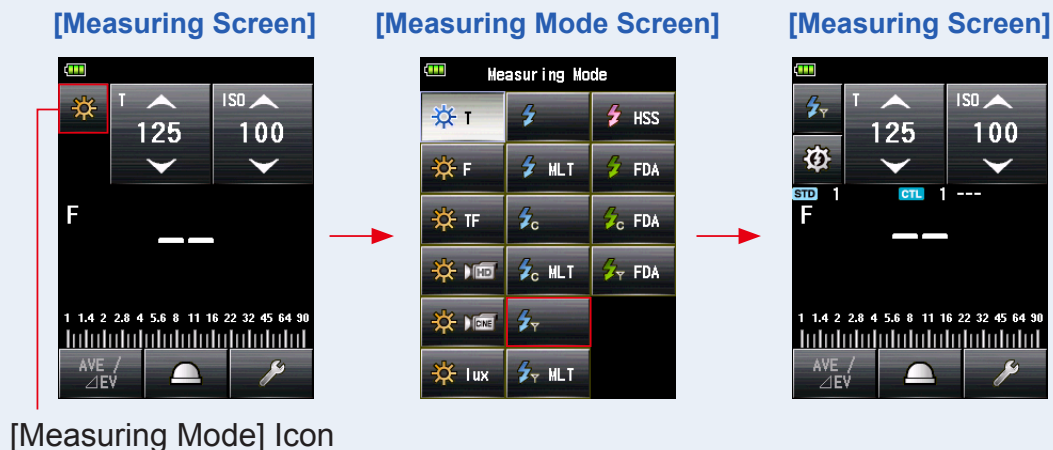
When it is selected, the display changes to the Measuring Screen.



3. Set the light receiving method.

Switch to the Incident light, extended lumisphere ()/retracted lumisphere (), or reflected light.

4. Set the ISO sensitivity value on the [ISO] Icon.

5. Set the shutter speed on the [T] Icon.

[Measuring Screen]

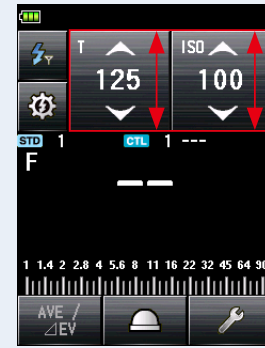

Setting Value

NOTICE

Make sure that the settings are within the specifications of the camera and flash system.

6. Make sure that the set radio system (STD or CTL), channel and Zones are the same between the meter and receivers in use. (→P4, P6)

[Measuring Screen]



Radio CH and Zones

7. Press the Measuring Button ⑥.

The flash will fire and the measured value (F-stop) will be displayed.

[Measuring Screen]

Measured value
(F-stop)

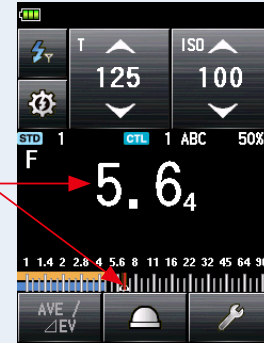

NOTICE

In case of the followings, please follow “Cord Flash Mode” ().

- When firing the flash, if the flash brightness is lower than the ambient light, the meter may fail to detect the flash light.
- Rapid start fluorescent lamps and special lighting are sometimes mistaken for flash, and accidentally measured.
- Even if the flash is not fired, when a sudden light change occurs in the light receptor, measurement may be made.
- The waveform of a flash bulb has a slight slope and there is a possibility that the light meter cannot recognize the flash bulb.

NOTE

For radio CH frequencies, refer to “5. Radio Channel Frequencies”. (➔ P29)

2) How to Use Flash Power Control

Power Control Function is available with ControlTL system only. Make sure that plug-in external or built-in PocketWizard receivers and flash units are compatible with the function of flash power control.

1. Touch the [Power Control] Icon () on the Measuring Screen. The Power Control Screen is displayed.

Take measurements by placing the meter at the subject position with the light receptor (retracted lumisphere) facing toward the light sources of main light and fill light directly. Adjust the measured values for the desired lighting ratio. (►Figure 1. of Piii)

2. Select one or more Zones (A to C) and the Power Bar will be activated.

Only flash unit with the receiver set to the selected Zone is fired.

[Measuring Screen]

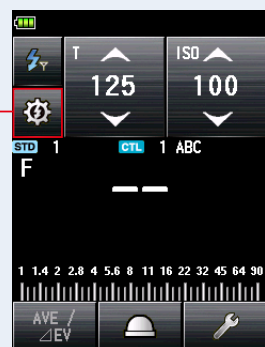

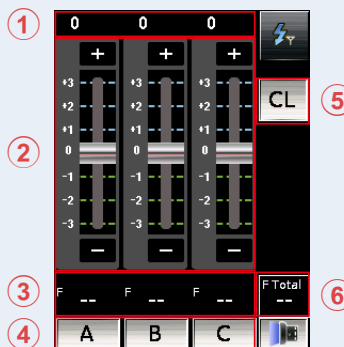

[Power Control] Icon

[Power Control Screen]



3. Press the Measuring Button .

The flash units of the selected Zones are fired, and the measured value (F-stop) is displayed at the top of the bar  and the "F Total" box at the bottom right of the screen .

4. Move the slider or touch the [+] or [-] Buttons to change the power of flash.

The set power level is displayed in the area above the slider .

[Power Control Screen]

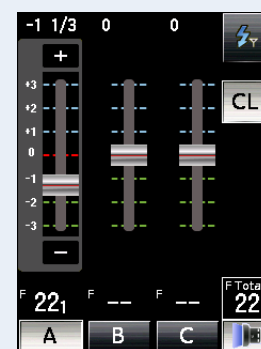

NOTICE

Although up to +/- 3 step of value (F-stop) can be set, the adjustment must be within the upper and lower limit of the power level specification of the flash unit.

5. Press the Measuring Button ⑥ again.

Check that the output power of the flash is the desired value.

6. Repeat Steps 2 to 5.

Repeat the procedure for other Zones until each flash unit's brightness is set to proper value for the effect you want.

7. Select all Zone buttons you want to use, and press the Measuring Button ⑥.







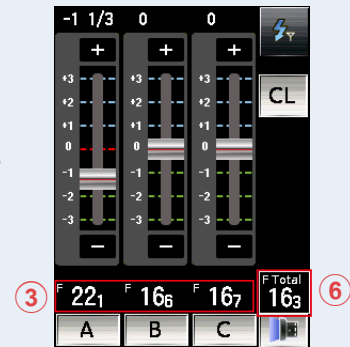



Point the meter (lumisphere) at the camera from the position of subject to make a measurement.

All flash units of the selected Zone are fired, and the total exposure (F-stop) ⑥ is shown in the main display. (Figure 2. of Piii)

[Power Control Screen]
(After Measurement)



NOTE

- To set ISO sensitivity and shutter speed, press the [Radio Triggering Flash Mode] Icon () to return to the Measuring Screen.
- The last selected Zones in either Power Control Screen or Radio CH/Zone Setting Screen in Tool Box are activated in Measuring Screen.
- Standard system radios can be used along with ControlTL system radios to trigger non-power control flashes at the same time. When a Standard channel number is set from 1 to 16, () (classic channel) button appears in the position of ⑤. When a channel number from 17 to 32 is selected, the Zones ( ,  ,  , ) will appear at the right of the screen ⑦. Touch () or Zones ( ,  ,  , ) to toggle them on or off.

[Power Control Screen]
(Standard CH1 to 16)

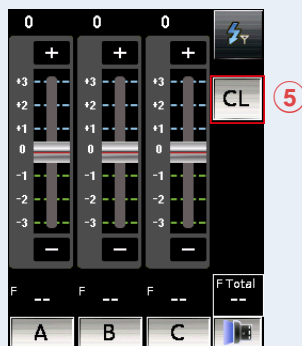

[Power Control Screen]
(Standard CH17 to 32)

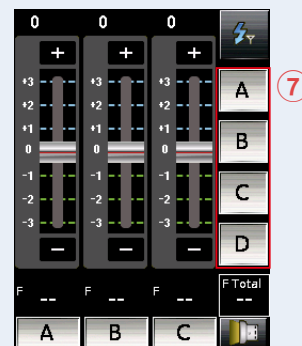

- Press Modeling Lamp ON () or OFF () if necessary after selecting the desired Zones.

2-4-2

Radio Triggering Multi (Cumulative) Flash Mode

This Measuring Mode is used when the light generated by the flash at one time is inadequate for the desired F-stop setting. Repeated flash pops can be accumulated until the desired F-stop value is displayed. The measured value (F-stop) is displayed for each trigger of the flash. The cumulative count is infinite. Up to 99 times is displayed in the Status/Title field, however, the cumulative count returns to 0 (zero) for more than 100 times (0=100, 1=101, 2=102, etc.).

In the Power Control Screen, the Multi (cumulative) flash measurement is not available (only single measurement is made).

Operation

1) How to Use Flash Triggering

1. Touch the [Measuring Mode] Icon on the Measuring Screen.

The Measuring Mode Screen is displayed.

2. Touch the [Radio Triggering Multi Flash Mode] Icon () in Measuring Mode Screen.

When it is selected, the display changes to the Measuring Screen.

[Measuring Screen]

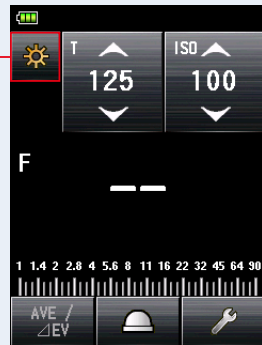

[Measuring Mode] Icon

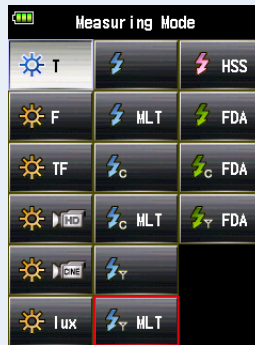

[Measuring Mode Screen]

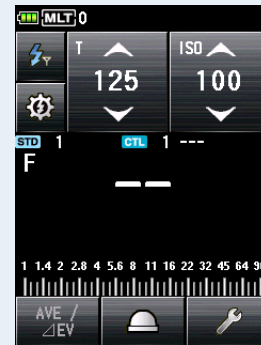

[Measuring Screen]



3. Set the light receiving method.

Switch to the Incident light, extended lumisphere ()/
retracted lumisphere (), or reflected light.

4. Set the ISO sensitivity value on the [ISO] Icon.

5. Set the shutter speed on the [T] Icon.

[Measuring Screen]

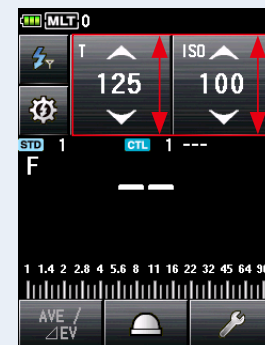

Setting Value

NOTICE

Make sure that the settings are within the specifications of the camera and flash system.

- 6. Make sure that the set radio system (STD or CTL), channel and Zones are the same between the meter and receivers in use. (→P4, P6)**

[Measuring Screen]



Radio CH and Zones

- 7. Press the Measuring Button ⑥.**

The measured value (F-stop) is displayed. Press the Measuring Button ⑥ again to fire a flash and measure until the desired F-stop is displayed.

The accumulated measured value (F-stop) and the cumulative count are displayed.

[Measuring Screen]

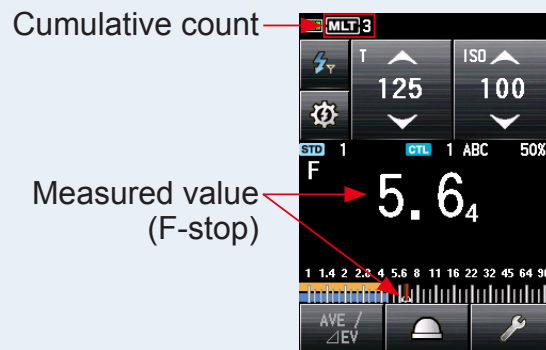

NOTICE

- In case of the followings, please follow “Cord Multi (Cum.) Flash Mode” ().
- When firing the flash, if the flash brightness is lower than the ambient light, the meter may fail to detect the light.
- Rapid start fluorescent lamps and special lighting are sometimes mistaken for flash and accidentally measured.
- Even if the flash is not fired, when a sudden light change occurs in the light receptor, measurement may be made.
- The waveform of a flash bulb has a slight slope and there is a possibility that the light meter cannot recognize the flash bulb.
- The EV scale cannot be displayed in the Radio Triggering Multi (Cum.) Flash Mode.

NOTE

For radio CH frequencies, refer to “5. Radio Channel Frequencies”. (→ P29)

2) Multi Clear

1. Touch the [Tool Box] Icon () on the Measuring Screen.
The Tool Box Screen is displayed.

2. Touch the [Next Page] Icon () of the Tool Box to display the Tool Box showing [Multi Clear].

This button is only enabled during measurement.

If the button is grayed out, the cumulative measurement is not made and the count cannot be cleared.

3. Touch the [Multi Clear] Button of the Tool Box.

The cumulate value is cleared, and the display returns to the Measuring Screen.

If you do not clear the value, touch the [Close] Button.

The display returns to the Measuring Screen.

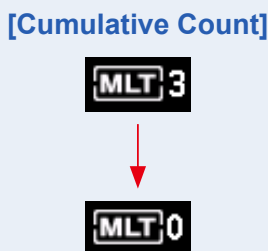
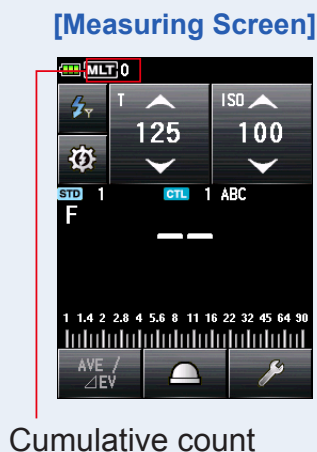
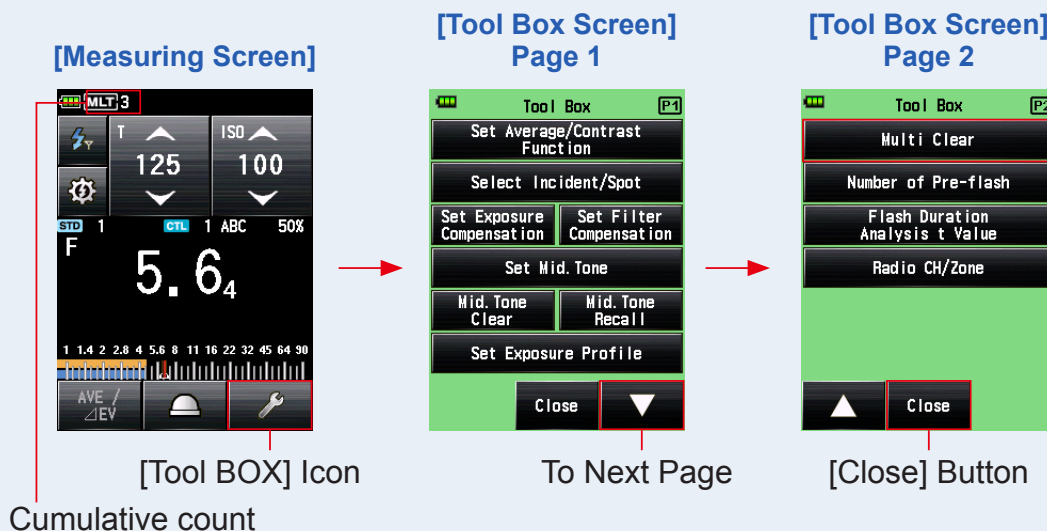

2-4-3 Flash Duration Analysis Radio Triggering Mode

The meter detects flash brightness after Measuring Button is pressed to send radio transmitted signal to radio receiver connected to flash. F-stop, flash duration time and graph of flash waveform are displayed for input ISO sensitivity and shutter speed. Flash Duration Analysis is performed with incident light Measuring Mode.

Operation

1) How to Use Radio Triggering

1. Touch the [Measuring Mode] Icon on the Measuring Screen.

The Measuring Mode Screen is displayed.

2. Touch the [Flash Duration Analysis Radio Triggering Mode] Icon () in Measuring Mode.

When it is selected, the display changes to the Measuring Screen.

If the reflected light mode is set, the Flash Duration Analysis Mode cannot be selected. Before switching to the Measuring Mode Screen, set the light receiving method to the incident light and select the Flash Duration Analysis Radio Triggering Mode.

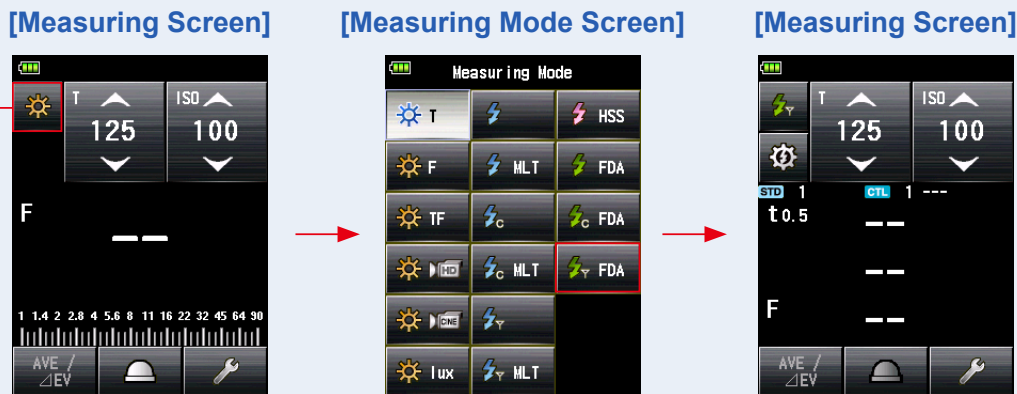

[Measuring Mode] Icon

3. Set the light receiving method.

Switch to the extended lumisphere () or retracted lumisphere ().

4. Set the ISO sensitivity value on the [ISO] Icon.

5. Set the shutter speed on the [T] Icon.

[Measuring Screen]

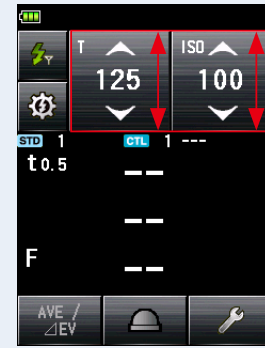

Setting Value

NOTICE

Make sure that the settings are within the specifications of the camera and flash system.

6. Set the Flash Duration Analysis t value. (→ P24)

7. Make sure that the set radio system (STD or CTL), channel and Zones are the same between the meter and receivers in use. (→P4, P6)

[Measuring Screen]



Radio CH and Zones

8. Press the Measuring Button ⑥.

The flash will fire, and the flash duration time and the measured value (F-stop) for input ISO sensitivity and shutter speed will be displayed.

[Measuring Screen]

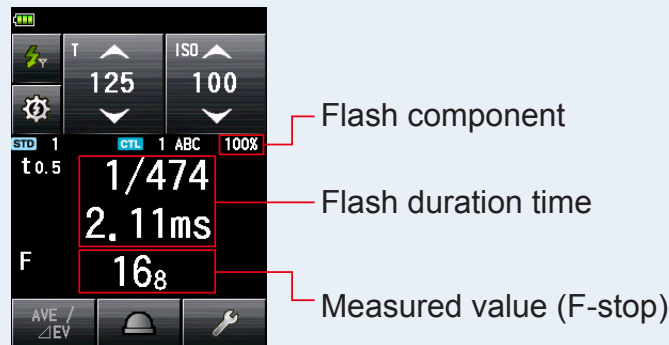

NOTICE

- The flash duration time and graph are displayed in the Flash Duration Analysis Radio Triggering Mode, however, they cannot be stored in the memory. They are cleared if the Measuring Mode is changed or the POWER Button is turned OFF.
- The incident light measurement can only be used in Flash Duration Analysis Radio Triggering Mode.
- In case of the followings, please follow “Flash Duration Analysis Cord Mode” ().
 - When firing the flash, if the flash brightness is lower than the ambient light, the meter may fail to detect the light.
 - Rapid start fluorescent lamps and special lighting are sometimes mistaken for flash and accidentally measured.
 - Even if the flash is not fired, when a sudden light change occurs in the light receptor, measurement may be made.
 - The waveform of a flash bulb has a slight slope and there is a possibility that the light meter cannot recognize the flash bulb.
- If the measured flash duration time is longer than the input shutter speed, an appropriate F-stop cannot be measured. The yellow “Under” indication appears. In this case, slower the shutter speed than the flash duration time and measure again.

[Measuring Screen]





NOTE

- When the measured value display area is touched, both flash waveform graph and measured value are displayed. When it is touched again, the display returns to the previous screen.

[Measuring Screen]

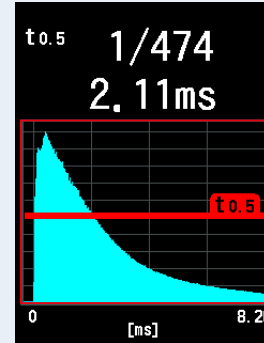

[Flash Duration Analysis Radio Triggering Mode Flash Waveform Graph Screen]





Touching the Measured value area changes the display.

* The graph screen cannot be used to make measurements.

- Measure the flash light characteristics in a darkroom without ambient light.
- For radio CH frequencies, refer to "5. Radio Channel Frequencies". (➔ P29)



2) How to Use Flash Power Control

Power Control Function is available with ControlTL system only. Make sure that plug-in external or built-in PocketWizard receivers and flash units are compatible with the function of flash power control.

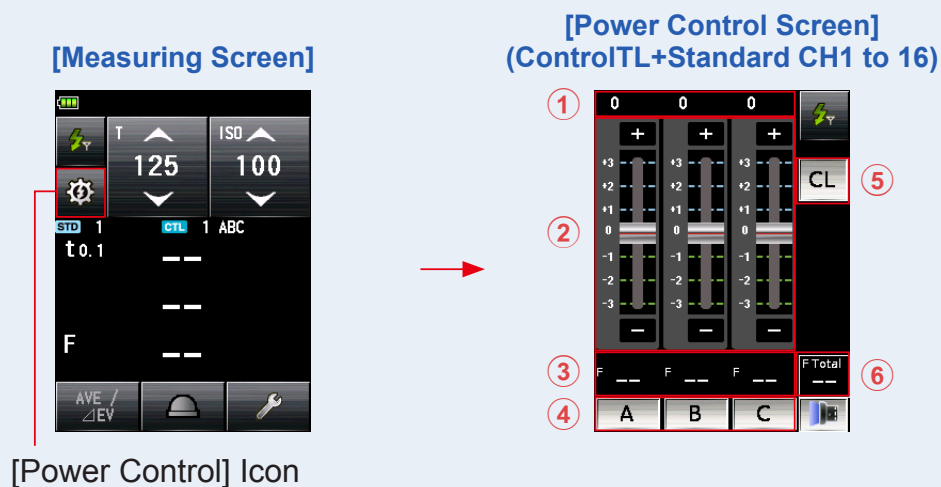
1. Set the Flash Duration Analysis t value. (➔ P24)
2. Make sure that the set radio system (STD or CTL), channel and Zones are the same between the meter and receivers in use. (➔ P4, P6)
3. Touch the [Power Control] Icon () on the Measuring Screen. The Power Control Screen is displayed.
4. Select one or more Zones (A to C)  and the Power Bar  will be activated.
Only flash unit with the receiver set to the selected Zone is fired.



5. Press the Measuring Button .

The flash units of the selected Zones are fired, and the measured value (F-stop) is displayed at the top of the bar  and the "F Total" box at the bottom right of the screen .

[Power Control Screen]
(ControlTL+Standard CH1 to 16)

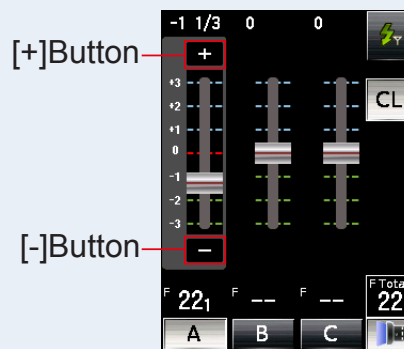

6. Move the slider or touch the [+] or [-] Buttons to change the power of flash.

The set power level is displayed in the area above the slider .

NOTICE

Although up to +/- 3 step of value (F-stop) can be set, the adjustment must be within the upper and lower limit of the power level specification of the flash unit.

7. Press the Measuring Button again.

Check that the output power of the flash is the desired value.

8. Press [Measuring Mode] Icon () .

The display returns to the Measuring Screen, and the flash duration time and the measured value (F-stop) for input ISO sensitivity and shutter speed will be displayed.

[Power Control Screen]
(After Measurement)

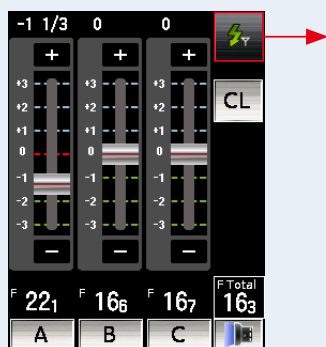

[Measuring Screen]

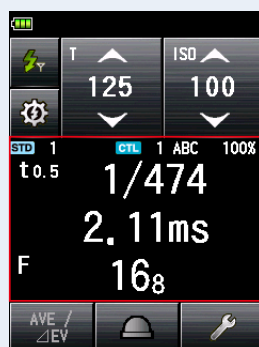

[Flash Duration Analysis
Radio Triggering Mode Flash
Waveform Graph Screen]

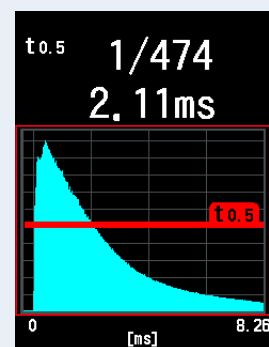

NOTE

- When the measured value display area is touched, both flash waveform graph and measured value are displayed. When it is touched again, the display returns to the previous screen.

[Measuring Screen]



[Flash Duration Analysis Radio Triggering Mode Flash Waveform Graph Screen]



Touching the Measured value area changes the display.

* The graph screen cannot be used to make measurements.

- Measure the flash light characteristics in a darkroom without ambient light.
- To set ISO sensitivity and shutter speed, press the [Flash Duration Analysis Radio Triggering Mode] Icon () to return to the Measuring Screen.
- The last selected Zones in either Power Control Screen or Radio CH/Zone Setting Screen in Tool Box are activated in Measuring Screen.
- For radio CH frequencies, refer to “5. Radio Channel Frequencies”. (➔ P24)

3) Flash Duration Analysis t Value

The t value can be set in steps of 0.1 at a range of 0.1 to 0.9.

The flash duration time varies depending on the input t value.

1. Touch the [Tool Box] Icon () on the Measuring Screen.

The Tool Box Screen is displayed.

2. Touch the [Next Page] Icon () of the Tool Box to display the Tool Box showing the [Flash Duration Analysis t Value] Button.

This button is enabled if Flash Duration Analysis Mode is selected. If it is grayed out, check the Measuring Mode.

3. Touch the [Flash Duration Analysis t Value] Button of the Tool Box.

The Flash Duration Analysis t Value Screen is displayed.

If you do not change this number, touch the [Close] Button.

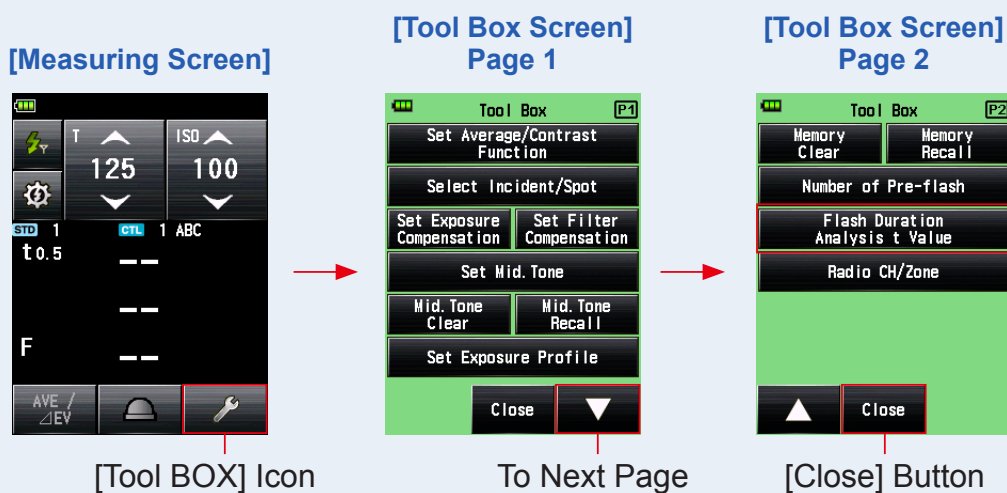

4. Enter the “Reference” of 0.1 to 0.9 by touching the numeric value.

The t value can be set in steps of 0.1 at a range of 0.1 to 0.9.

The first “0.” is fixed. Enter the first digit decimal only. (To set “0.1”, enter “1”.)

[Flash Duration Analysis t Value Screen]

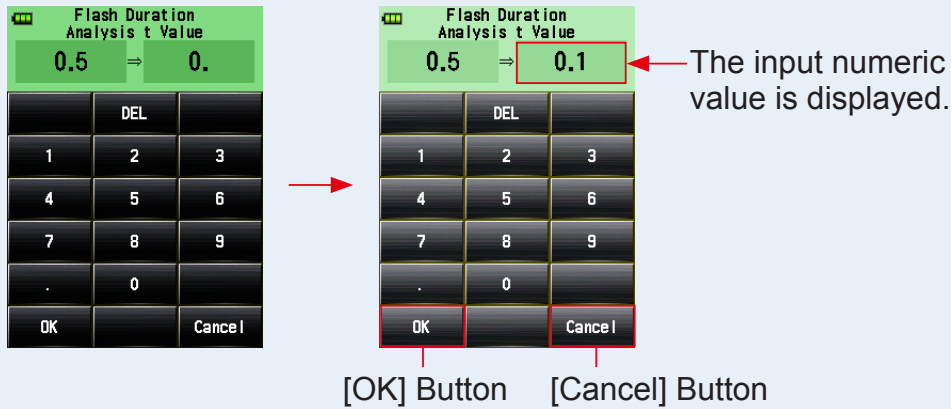

5. Touch [OK] Button.

The setting is entered, and the display returns to the Measuring Screen.

Touch the [Cancel] Button to return to the Measuring Screen without making the modification.

[Measuring Screen]



NOTE

Two rules apply to the reference flash duration time.

t0.5 = Effective flash duration time

t0.1 = Total flash duration time

After flash firing, the time at which the maximum intensity drops by half is called “t0.5”. The time at which the maximum intensity drops to 1/10 is called “t0.1”.

Generally, “t0.5” is called the flash duration time.

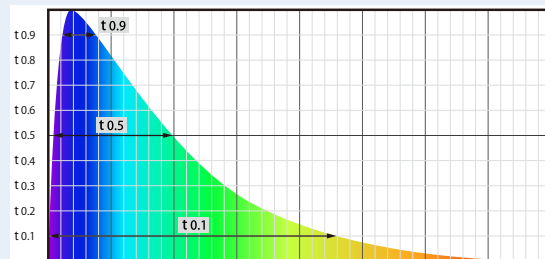

3. Product Information

This screen displays the detailed information not displayed in the Measuring Screen.

[Product Information Screen]

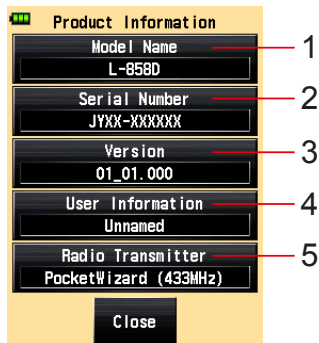

* The screen contents above differ depending on models.

No.	Item	Description
1	Model Name	Displays the model number of the meter.
2	Serial Number	Displays the serial number of the meter.
3	Version	Displays the firmware version.
4	User Information	Displays user-input information such as ownership or meter function, etc which is set in the Hardware Setting.
5	Radio Transmitter	Displays the type of radio frequency.

Operation

1. Touch the Menu Button **9** on the meter.

The Menu Screen is displayed.

2. Touch the [Next Page] Icon () to display page 2 of the Menu Screen, and touch the [Product Information] Button.

The Product Information Screen is displayed.

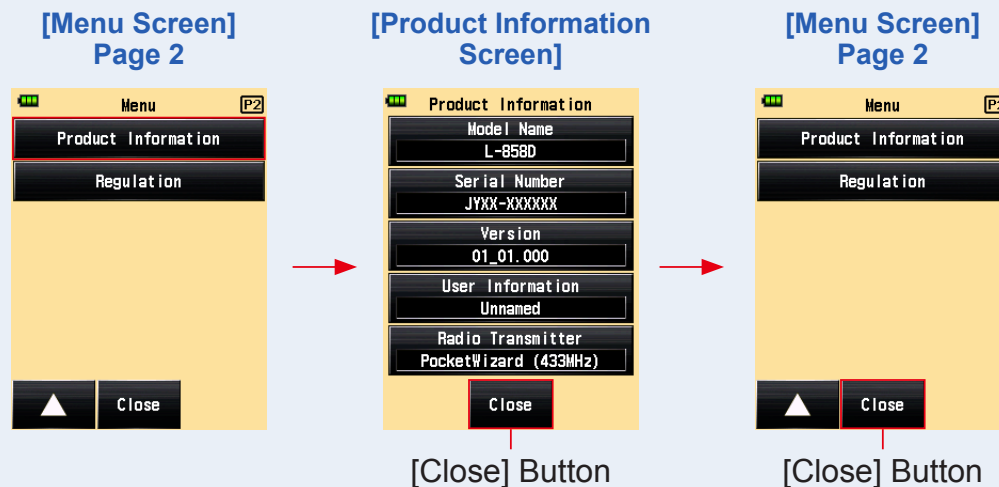

3. Touch the [Close] Button.

The display return to the Menu Screen.

4. Touch the [Close] Button.

The display returns to the Measuring Screen.

4. Regulation

The Regulation Screen displays the symbols, approved number, regulation names, etc. which the meter is compliance with.

Operation

1. Touch the Menu Button ⑨ on the meter.
The Menu Screen is displayed.
2. Touch the [Next Page] Icon (▼) to display page 2 of the Menu Screen, and touch the [Regulation] Button.
The Regulation Screen is displayed.

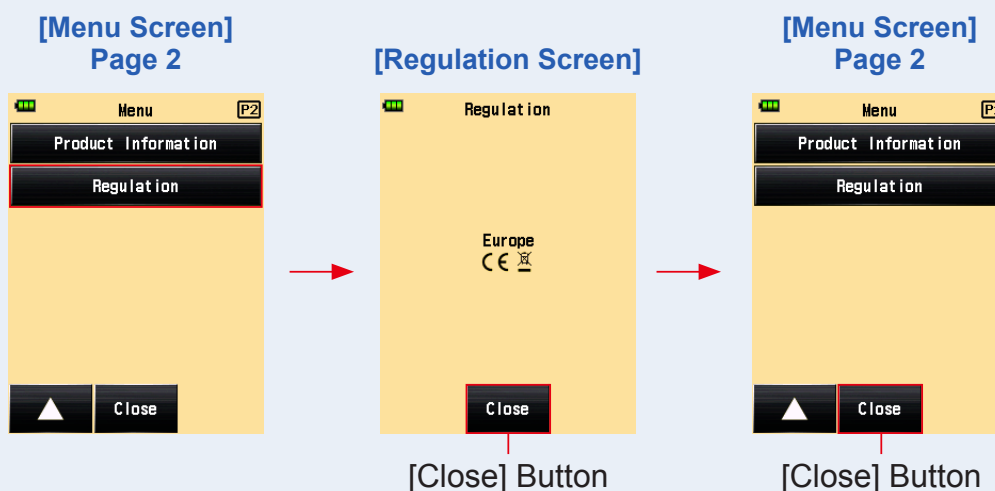

* The contents on the Regulation Screen vary depending on the destination or whether a transmitter (sold separately) is installed.

3. Touch the [Close] Button.
The display return to the Menu Screen.
4. Touch the [Close] Button.
The display returns to the Measuring Screen.

5. Radio Channel Frequencies

Radio wave frequency:

Regulation	Radio System	Channel Number	Frequency
RT-20PW FCC & Canada IC	Standard	CH1 ~ 16	344.04MHz
		CH17 ~ 32	346.5 ~ 354.0MHz
	ControlTL	CH1 ~ 4	340.0 ~ 346.0MHz
		CH5 ~ 20	341.5 ~ 351.0MHz
RT-3PW CE & NCC	Standard	CH1 ~ 16	433.62MHz
		CH17 ~ 32	434.22MHz
	ControlTL	CH1 ~ 3	433.42 ~ 434.42MHz

Zone: Standard System: A to D (from CH 17 to CH 32)

ControlTL System: A to C (all channel)

Radio triggering range: 30 meter (100 feet)





NOTICE

The working distance of the radio triggering system can vary with the orientation and location of the meter and receivers.

6. Legal Requirements

This product complies with the following legal requirements.

Destination	Standard		Details
Europe	CE 	Wireless	EN300 220-2 V2.4.1 EN301 489-1 V1.9.2 EN301 489-3 V1.6.1 EN62479:2010
North America	FCC (US) 	Wireless	FCC Part15 SubpartC
	IC (Canada)	Wireless	RSS-210 Issue9

FCC & IC compliance information:

Compliance statement to FCC and Industry Canada

FCC ID: PFK-RT20-01

This device complies with Part 15 of the FCC Rules.

Operation is subject to the following two conditions:

- (1) this device may not cause harmful interference, and
- (2) this device must accept any interference received, including interference that may cause undesired operation.

The user is cautioned that unauthorized changes or modifications not approved could void the user's authority to operate the equipment.

IC: 3916A-RT20001

Operation is subject to the following two conditions:

- (1) this device may not cause interference, and
- (2) this device must accept any interference, including interference that may cause undesired operation of the device.

Le present appareil est conforme aux CNR d'Industrie Canada applicables aux appareils radio exempts de licence. L'exploitation est autorisee aux deux conditions suivantes :

- (1) l'appareil ne doit pas produire de brouillage, et*
- (2) l'utilisateur de l'appareil doit accepter tout brouillage radioelectrique subi, meme si le brouillage est susceptible d'en compromettre le fonctionnement.*

7. Troubleshooting

If your meter is not operating properly, as you expect, please consult the following conditions and attempt the suggested solutions before contacting Sekonic. Non-operation can be due to incorrect, mis-setting of the meter or battery condition. Should your meter be malfunctioning, please contact place where meter was purchased or Sekonic for service and repair.

Condition	Possible reasons	What to do
Flash cannot be triggered in Radio Triggering Flash Mode.	Is the radio receiver in the flash compatible with the meter's transmitter? Isn't any other non-compatible brand or manufacturer used?	Make sure that both the meter and plug-in external or built-in PocketWizard receivers to the same system. http://www.pocketwizard.com/
	Are the meter transmitter and receivers set for the same channel number and Zones?	Set the same channel number and Zones on the transmitter and the receivers.
	Are the meter and receiver set for the same radio system: ControlTL and/or Standard?	Check that the transmitter and receiver are both set to the same system (either Standard system or ControlTL system).
	Are the meter transmitter and receiver set for the same frequency?	As there are two types of frequency (344 MHz band and 433 MHz band), ensure that the transmitter and frequency have the same specifications.

SEKONIC CORPORATION

7-24-14, Oizumi-Gakuen-cho, Nerima-ku Tokyo
178-8686 JAPAN

Tel +81-3-3978-2335 Fax +81-3-3978-5229

<http://www.sekonic.com>

JX5197630
February 2017