

SmallRig

“Night Eagle” Cage Kit

(for Nikon Z5 / Z5II / Z6 / Z6II / Z7 / Z7II)

「夜鷹」拓展框套件

(适用于尼康Z5 / Z5II / Z6 / Z6II / Z7 / Z7II)

(5258 / 5259)

Operating Instruction / 操作指引

- Thank you for purchasing SmallRig's product.
感谢您购买 SmallRig 产品。
- Please read this Operating Instruction carefully.
使用本产品之前，请仔细阅读操作指引。
- Please follow the safety warnings.
请注意所有警告提示并遵循使用操作指引的所有指令。

Specifications / 产品参数

5258	Product Dimensions 产品尺寸	6.3 × 2.4 × 4.5in 160.0 × 60.0 × 113.5mm
	Product Weight 产品重量	6.2 ± 0.2oz 177.0 ± 5.0g
	Material(s) 主要材质	Aluminum Alloy, Stainless Steel 铝合金, 不锈钢
	In the Box 包装清单	Cage × 1 拓展框 Cold Shoe Mount × 1 冷靴 Operating Instruction × 1 操作指引 Guarantee Card × 1 保修卡
5259	Product Dimensions 产品尺寸	6.7 × 5.7 × 7.3in 171.0 × 145.5 × 184.2mm
	Product Weight 产品重量	13.1 ± 0.2oz 371.0 ± 5.0g
	Material(s) 主要材质	Aluminum Alloy, Stainless Steel 铝合金, 不锈钢
	In the Box 包装清单	Cage × 1 Top Handle × 1 拓展框 上手提 HDMI & USB-C Cable Clamp × 1 HDM I& USB-C线夹 Cold Shoe Mount × 1 冷靴 Operating Instruction × 1 操作指引 Guarantee Card × 1 保修卡

Product Details / 产品介绍

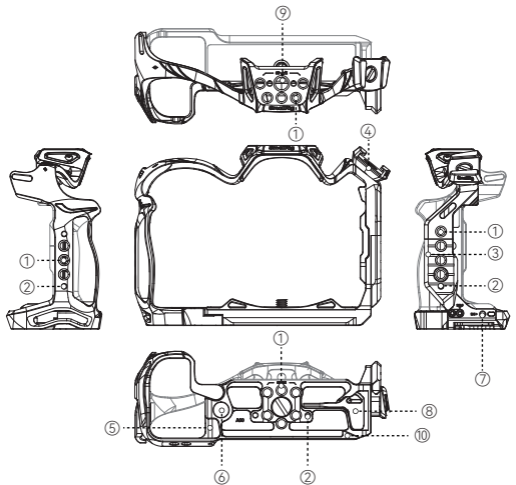

① 1/4"-20 Threaded Hole
1/4"-20 螺纹孔

② 1/4"-20 Locating Hole
1/4"-20 定位孔

③ H21 NATO Rail
H21 快拆滑条

④ Cold Shoe Mount
冷靴

⑤ Strap Slot
肩带 / 腕带接口

⑥ QD Socket
QD接口

⑦ M4 Threaded Hole
M4 螺纹孔

⑧ Dual-Head Wrench
双头扳手

⑨ ARRI 3/8"-16 Locating Hole
阿莱(ARRI)定位孔

⑩ H38 Arca-Swiss Quick Release Plate
H38 快拆阿卡规格快装板

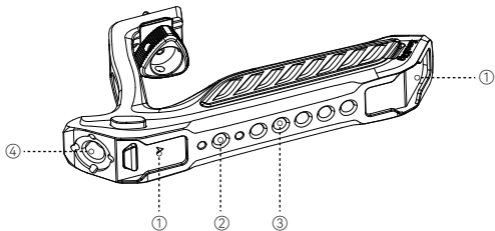

① Cold Shoe Mount
冷靴

② 1/4"-20 Locating Hole
1/4"-20 定位孔

③ 1/4"-20 Threaded Hole
1/4"-20 螺纹孔

④ ARRI 3/8"-16 Locating Hole
阿莱(ARRI)定位孔

Cage Installation / 拓展框安装步骤

1. Remove the split D-rings on the both sides before installing the cage.

1. 取下相机双侧肩带环。

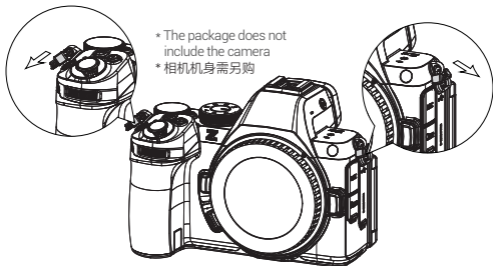

2. Install the camera into the cage from the back.

2. 将相机从后往前放入相机拓展框。

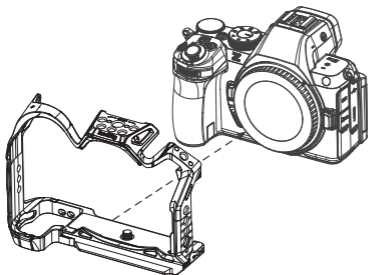

* The package does not include the camera

* 相机机身需另购

3. Install the cage by tightening the 1/4"-20 screw on the bottom.

拧紧底部1/4"-20 螺丝，锁紧固定拓展框。

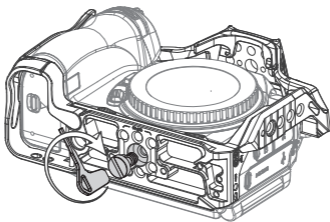

* The package does not include the camera

* 相机机身需另购

Remove both M2.5 screws from the cage sides. Thread the screws through the camera's shoulder strap holes. Secure the screws back into the cage.

取下拓展框侧边的两颗M2.5螺丝，然后将M2.5螺丝分别穿过相机双侧肩带孔与拓展框锁紧固定。

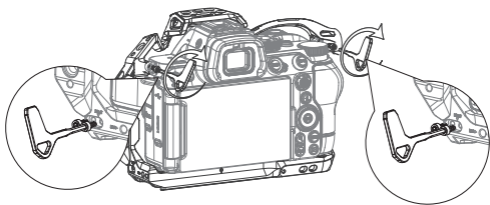

* The package does not include the camera

* 相机机身需另购

Cold Shoe Mount Installation Instruction / 冷靴安装步骤

Attach the cold shoe to any 1/4"-20 locating hole to fit your needs.

可将冷靴安装至拓展框顶部或双侧有内置1/4"-20 定位螺纹孔处。

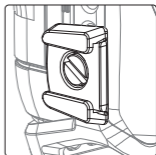
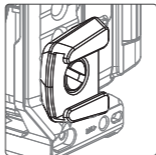
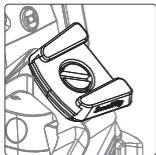

Top Handle Installation Instruction / 上提手柄安装步骤

- 1 Align the top handle with the ARRI 3/8"-16 locating hole on the cage.
将上手提对准相机拓展框的阿莱 (ARRI) 定位孔。
- 2 Tighten the ARRI 3/8"-16 locating screw with the dual-head wrench.
拧紧阿莱 (ARRI) 定位螺丝，使用双头扳手加固锁紧。

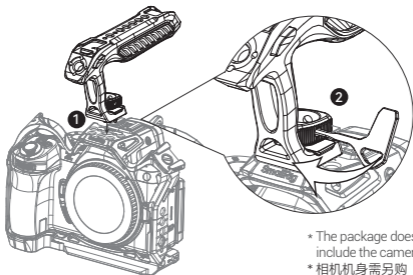

- * The package does not include the camera
- * 相机机身需另购

Screw Storage Solution / 存储或取用螺丝

Open the silicone cover on the left side of the handle to store or access screws (such as 1/4"-20 screws, 3/8"-16 screws, M2.5 screws).

打开上手提左侧硅胶盖，即可存储或取用螺丝（如1/4"-20螺丝、3/8"-16螺丝、M2.5螺丝）。

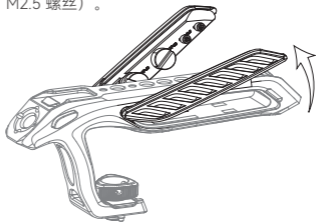

HDMI & USB-C Cable Clamp Installation Instruction

HDMI & USB-C线夹安装步骤

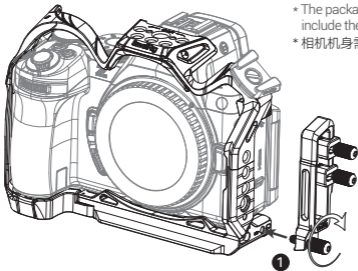

- * The package does not include the camera
- * 相机机身需另购

- * The package does not include the camera
- * 相机机身需另购

- 2 Flip the clamp back, and insert the HDMI & USB-C cables.
转回线夹，插入HDMI & USB-C线。

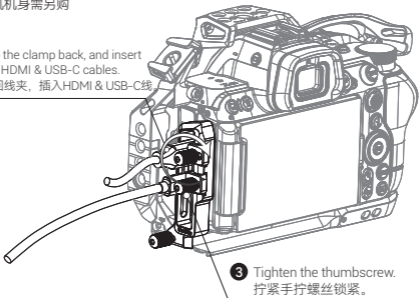

Manufacturer Email: support@smallrig.com

Manufacturer: Shenzhen Leqi Innovation Co., Ltd.

制造商: 深圳市乐其创新股份有限公司

Add: Rooms 101, 701, 901, Building 4, Gonglianfuji Innovation Park, No. 58, Ping'an Road, Dafu Community, Guanlan Street, Longhua District, Shenzhen, Guangdong, China.

地址: 中国广东省深圳市龙华区观澜街道大富社区平安路58号共联富基创新园4栋101、701、901

Consignor: Shenzhen LC Co., Ltd.

委托商: 深圳市乐长科技有限公司

Add: Room 201, Building 4, Gonglianfuji Innovation Park, No. 58, Ping'an Road, Dafu Community, Guanlan Street, Longhua District, Shenzhen, Guangdong, China.

地址: 中国广东省深圳市龙华区观澜街道大富社区平安路58号共联富基创新园4栋201

执行标准: GB/T 26572-2011

LQ-P1496-18

RoHS



Séparez les éléments avant de trier

中国制造
Made in China

合格证
已检验



SmallRig

FREE YOUR DREAM